



TDA-V Series

DIRECT DRIVE VANE AXIAL FAN



Material

Double flanged casing is produced in mild steel or galvanized steel, impeller blades are available in PPG, PAG or Aluminum material.

Finish

Painting or galvanized after manufacture is normal finish on all parts.

Operating Temperature

- General ventilation: -20 to +55°C.
- Smoke exhaust: 250°C/300°C - 1~2 hours. (TÜV SÜD certified). Higher temperature rating is available upon request.

Motors

- General ventilation: Totally Enclosed Fan Cooled (TEFC), Class "F".
- Smoke exhaust system: Totally Enclosed Fan Cooled (TEFC) High Temperature Rated (250°C/300°C TÜV SÜD certified). IP55 protection. Standard motors up to 2.2kW are supplied with DOL starting. Motors 3.0kW and above are with star/delta starting. Motors of other specification are available upon request.
- Motor should be selected to handle air at ambient temperature based on specified air volume and static pressure. This is to allow periodic testing of the fan.

Airflow Direction

Air flow from impeller to motor is fitted as standard.

Feature

For commercial and industrial applications where large volume of air is required at moderate to high pressure. Specially designed guide vanes help to reduce turbulence and achieve high efficiency and low sound level.

Certification



Kruger Ventilation Industries Asia Co., Ltd certifies that the **TDA-V series** shown herein is licensed to bear the AMCA Seal. The ratings shown are based on tests and procedures performed in accordance with AMCA Publication 211 and comply with the requirements of the AMCA Certified Ratings Program.



Certified by **TÜV SÜD** which is a leading international service organization focusing on consulting, testing, certification and training.

TDA-V series was tested in accordance with *EN 12101-3:2002*.

Class	Temperature (°C)	Minimum functioning period (minutes)
F200	200	120
F300	300	60
F400	400	120
F600	600	60
F842	842	842
Others	250	120
Others	300	120

Nomenclature

MODEL: TDA 630-V / 12AA / 7-7 / 12 / PPG / F (300°C / 2hrs)

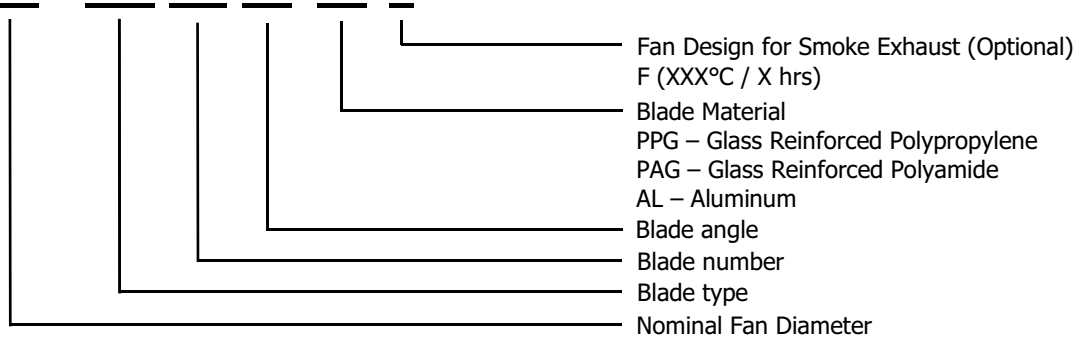

Dimension

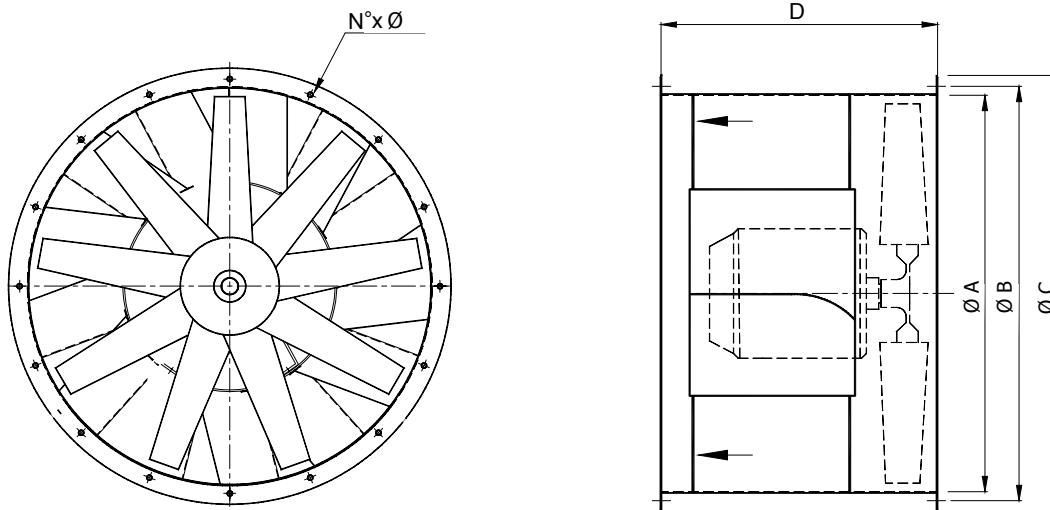

Model	A	B	C	D	N	Ø	Weight* (kg)	Max. Motor Frame Size**
560	560	605	660	500	12	10	33	D112M
630	630	675	730	500	12	10	35	D112M
710	710	755	810	500	18	12	65	D112M
800	800	845	900	560	18	12	71	D132M
900	900	945	1000	630	18	12	99	D160M
1000	1000	1050	1100	630	24	12	112	D160M
1120	1120	1185	1250	900	24	12	194	D225M
1250	1250	1315	1380	1000	24	12	283	D250M
1400	1400	1465	1530	1100	32	14	340	D250M
1600	1600	1663	1730	1250	32	14	491	D250M
1800	1800	1856	1930	1400	32	14	650	D280M
2000	2000	2073	2130	1400	32	14	720	D315M

*Weight without motor and impeller.

**Please consult KRUGER if motor frame size is beyond the catalogue range.

All Dimension in mm.

$\rho=1.2\text{kg/m}^3$
Hub: 186

FEG 71

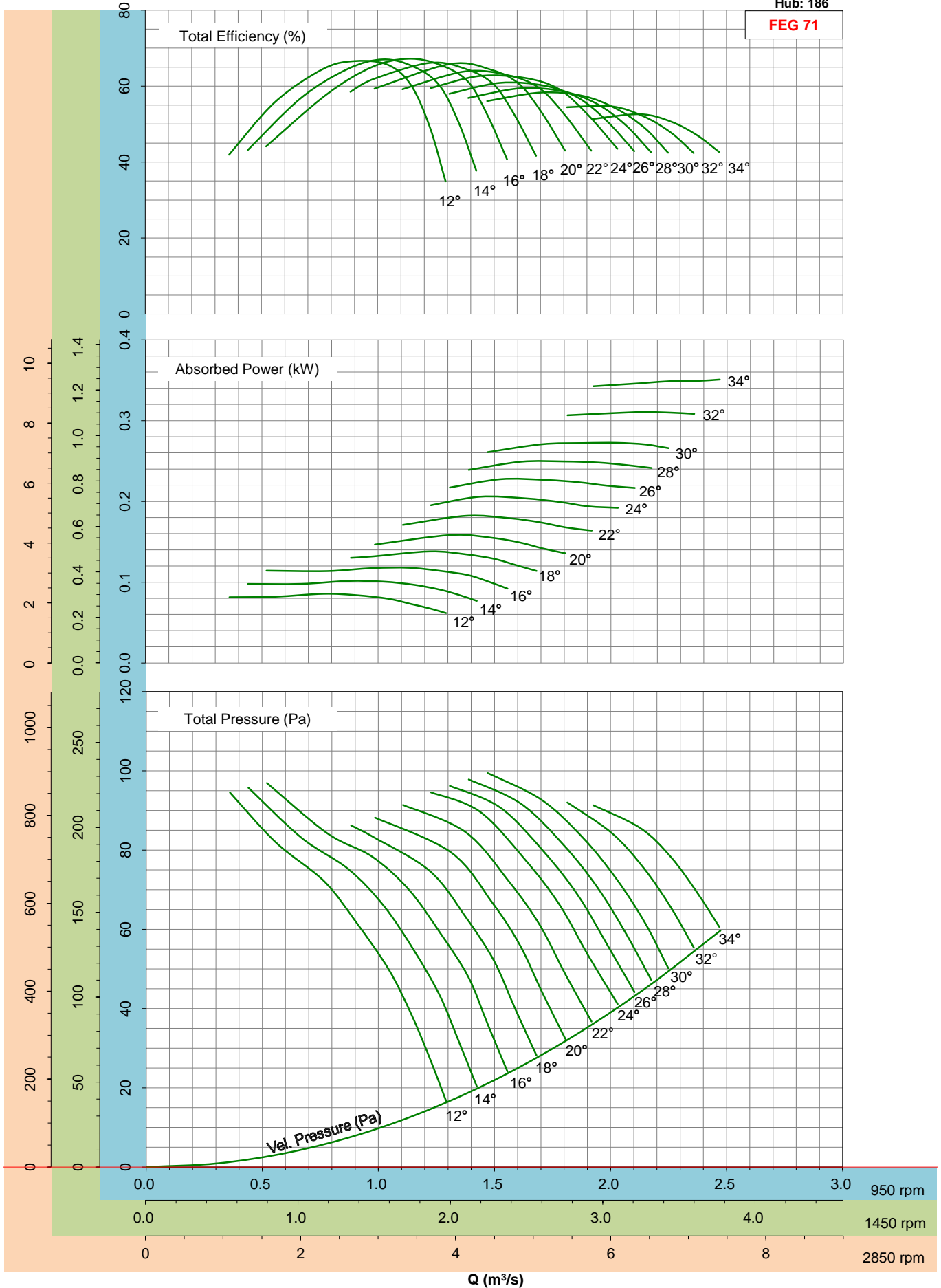

- Performance certified is for installation type D - ducted inlet, ducted outlet. Performance ratings do not include the effects of appurtenances (accessories).

$\rho=1.2\text{kg/m}^3$
Hub: 186

FEG 71

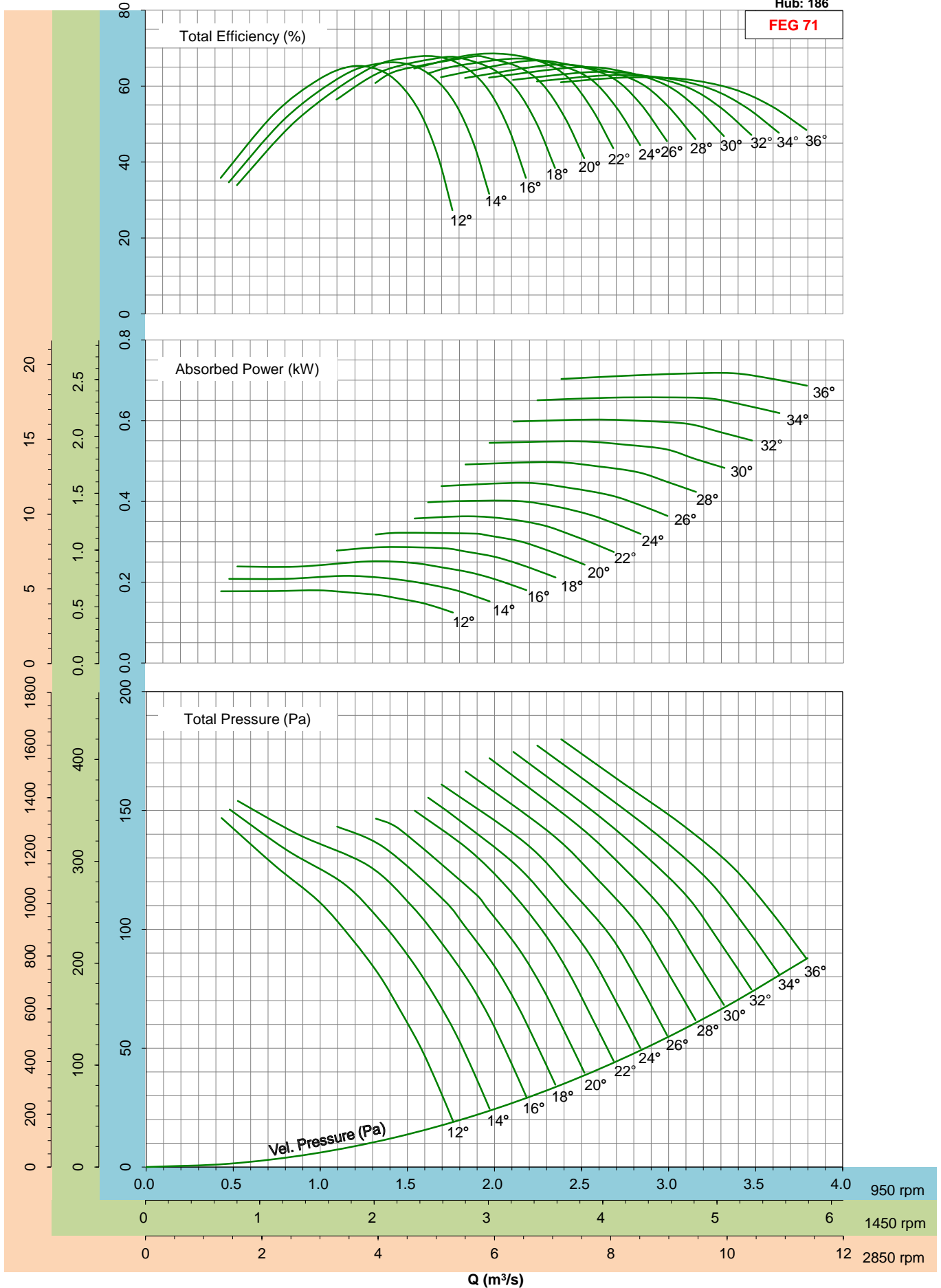

- Performance certified is for installation type D - ducted inlet, ducted outlet. Performance ratings do not include the effects of appurtenances (accessories).

- Please consult the nearest Kruger office for fan selection at 2850rpm.

$\rho=1.2\text{kg/m}^3$
Hub: 145

FEG 71

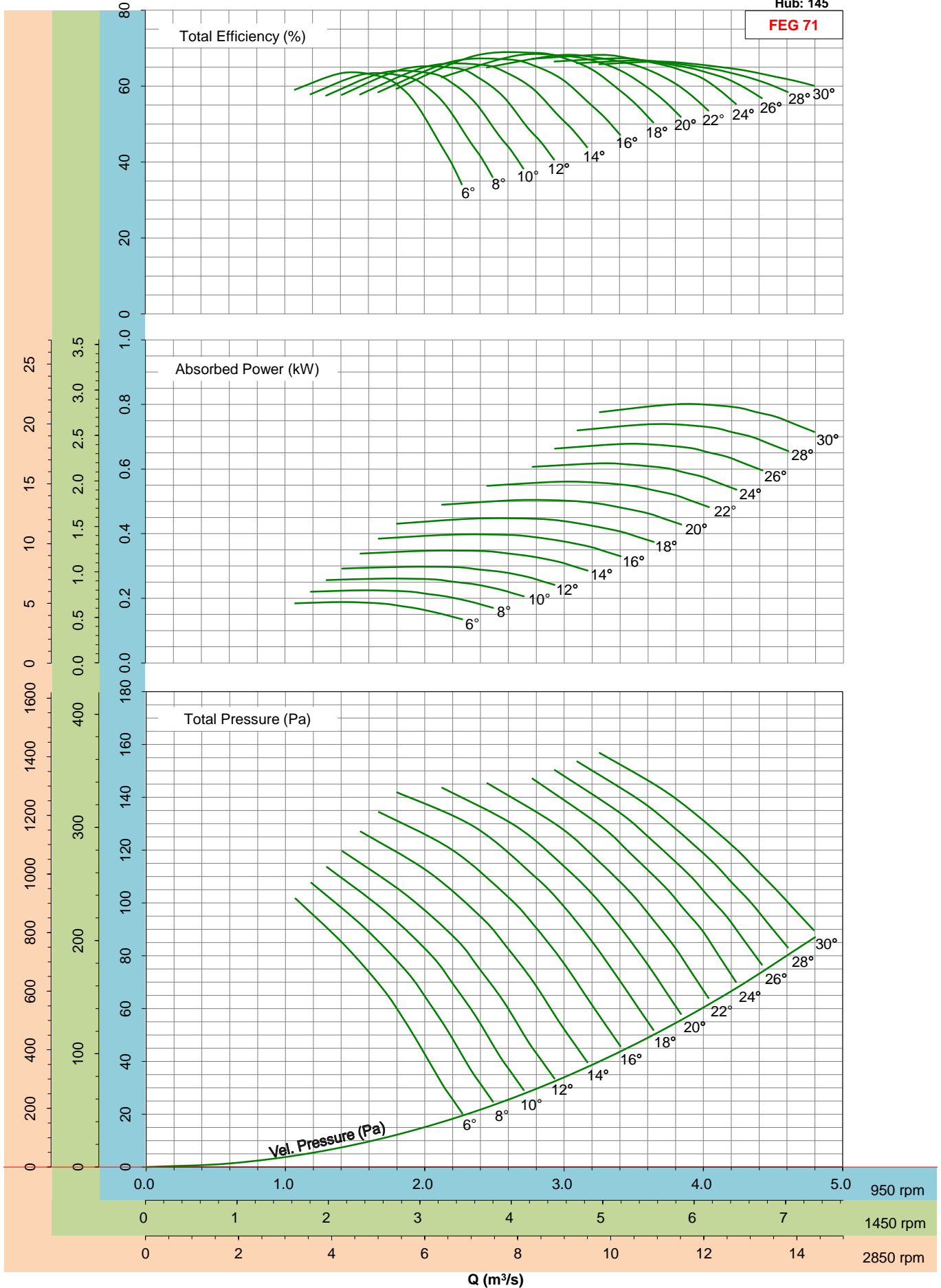

- Performance certified is for installation type D - ducted inlet, ducted outlet. Performance ratings do not include the effects of appurtenances (accessories).

- Please consult the nearest Kruger office for fan selection at 2850rpm.

$\rho=1.2\text{kg/m}^3$
Hub: 186

FEG 71

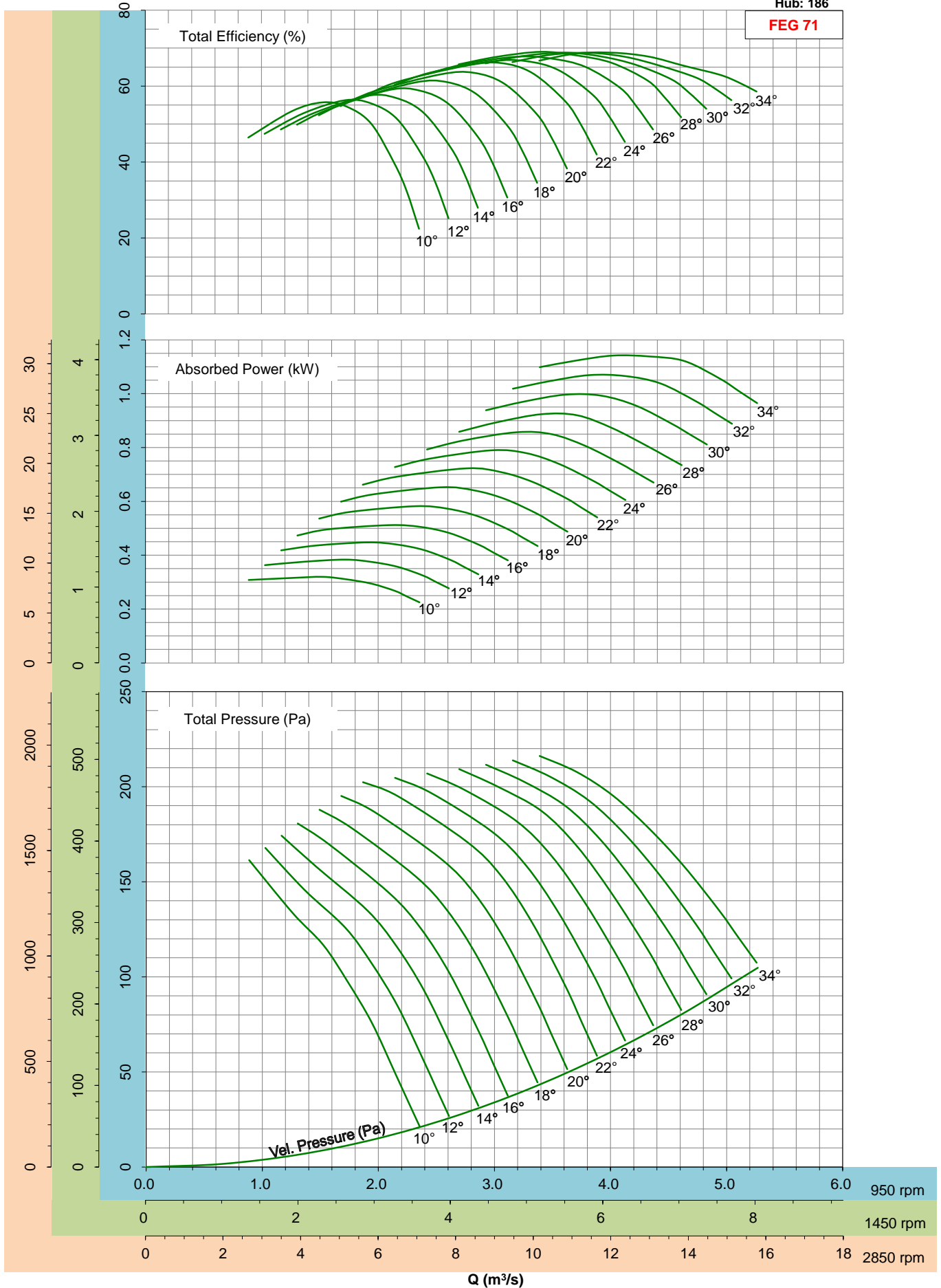

- Performance certified is for installation type D - ducted inlet, ducted outlet. Performance ratings do not include the effects of appurtenances (accessories).

- Please consult the nearest Kruger office for fan selection at 2850rpm.

$\rho=1.2\text{kg/m}^3$
Hub: 186

FEG 75

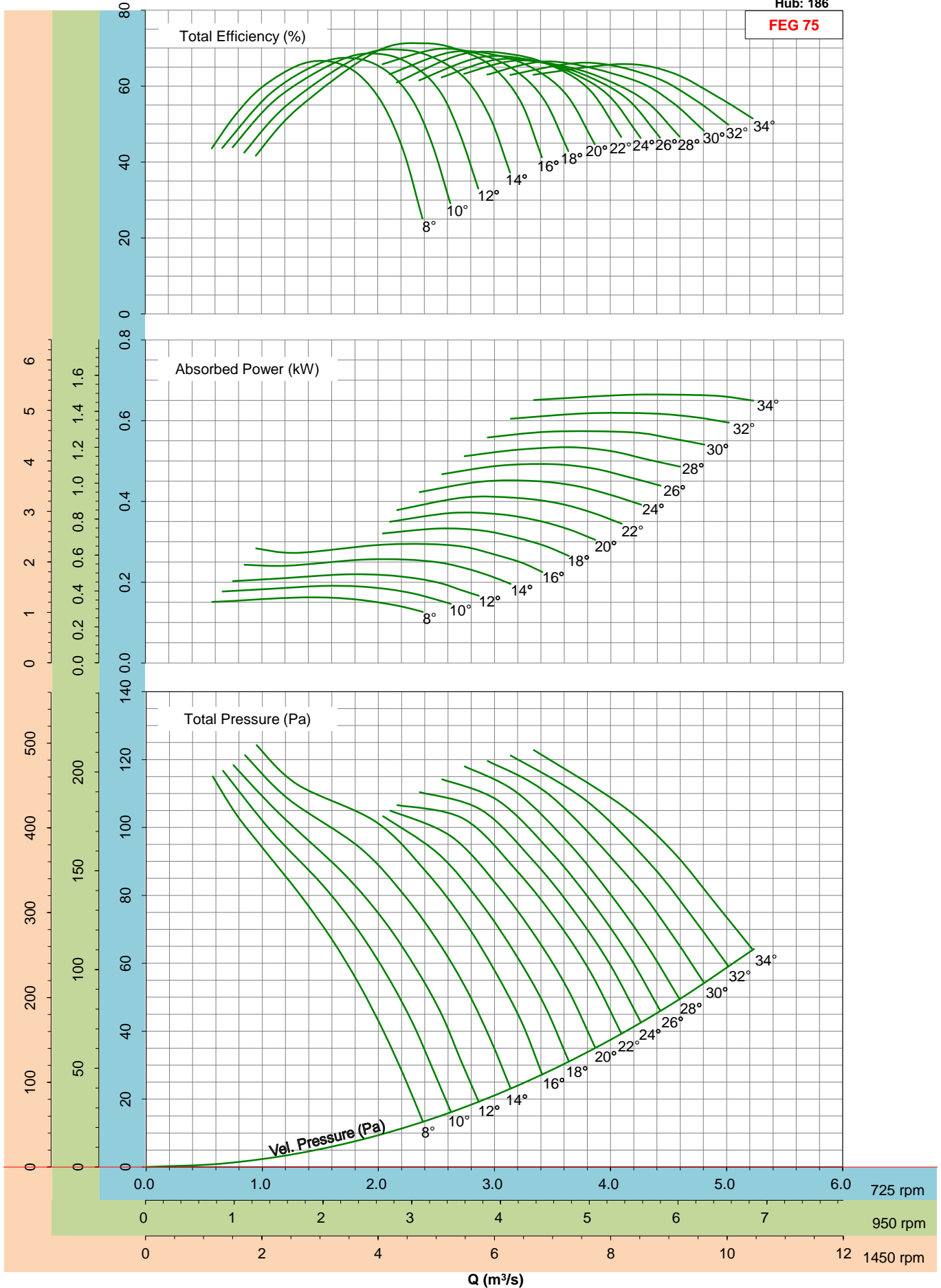

- Performance certified is for installation type D - ducted inlet, ducted outlet. Performance ratings do not include the effects of appurtenances (accessories).

$\rho=1.2\text{kg/m}^3$
Hub: 200

FEG 75

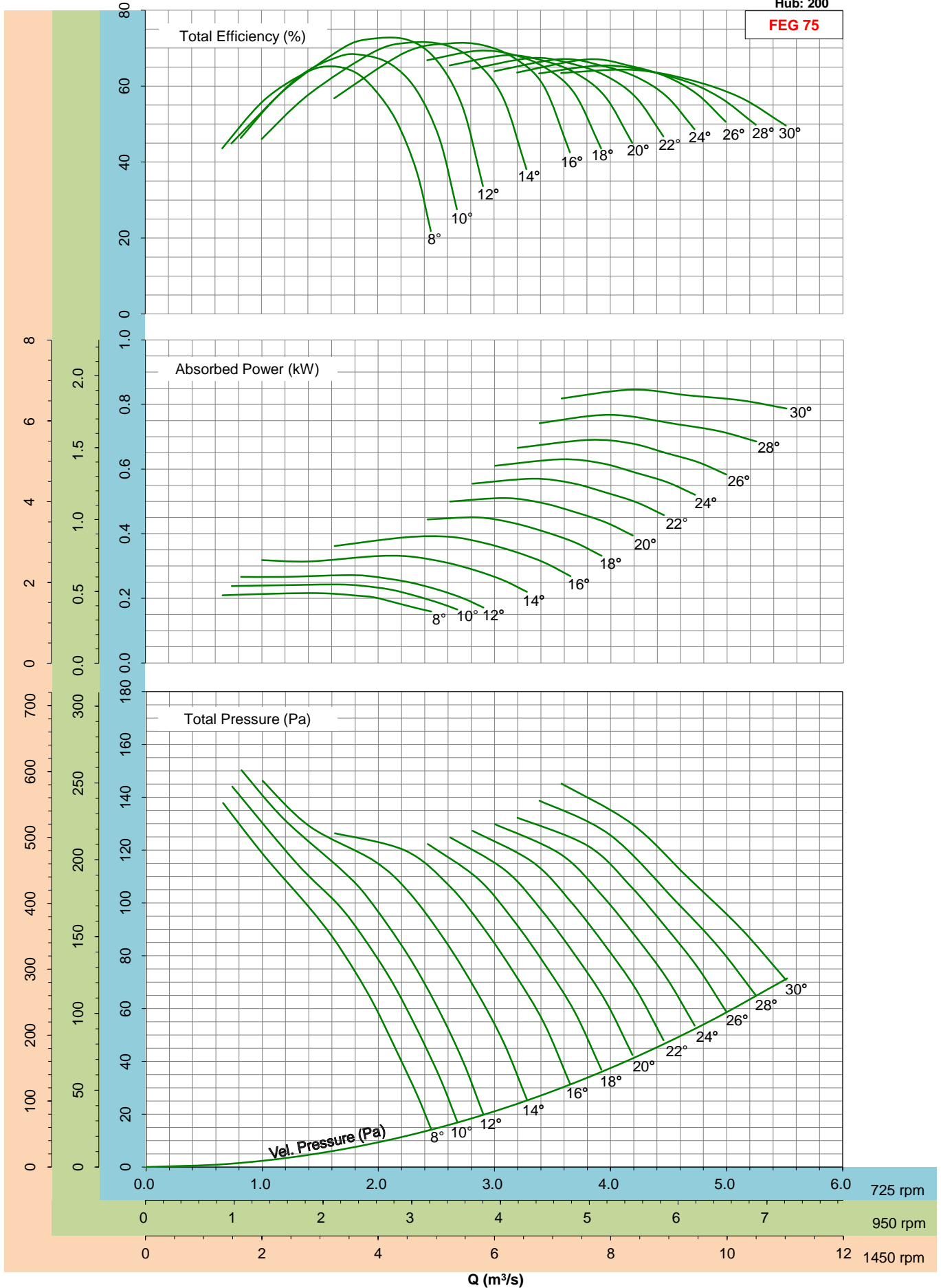

- Performance certified is for installation type D - ducted inlet, ducted outlet. Performance ratings do not include the effects of appurtenances (accessories).

$\rho=1.2\text{kg/m}^3$
Hub: 280

FEG 75

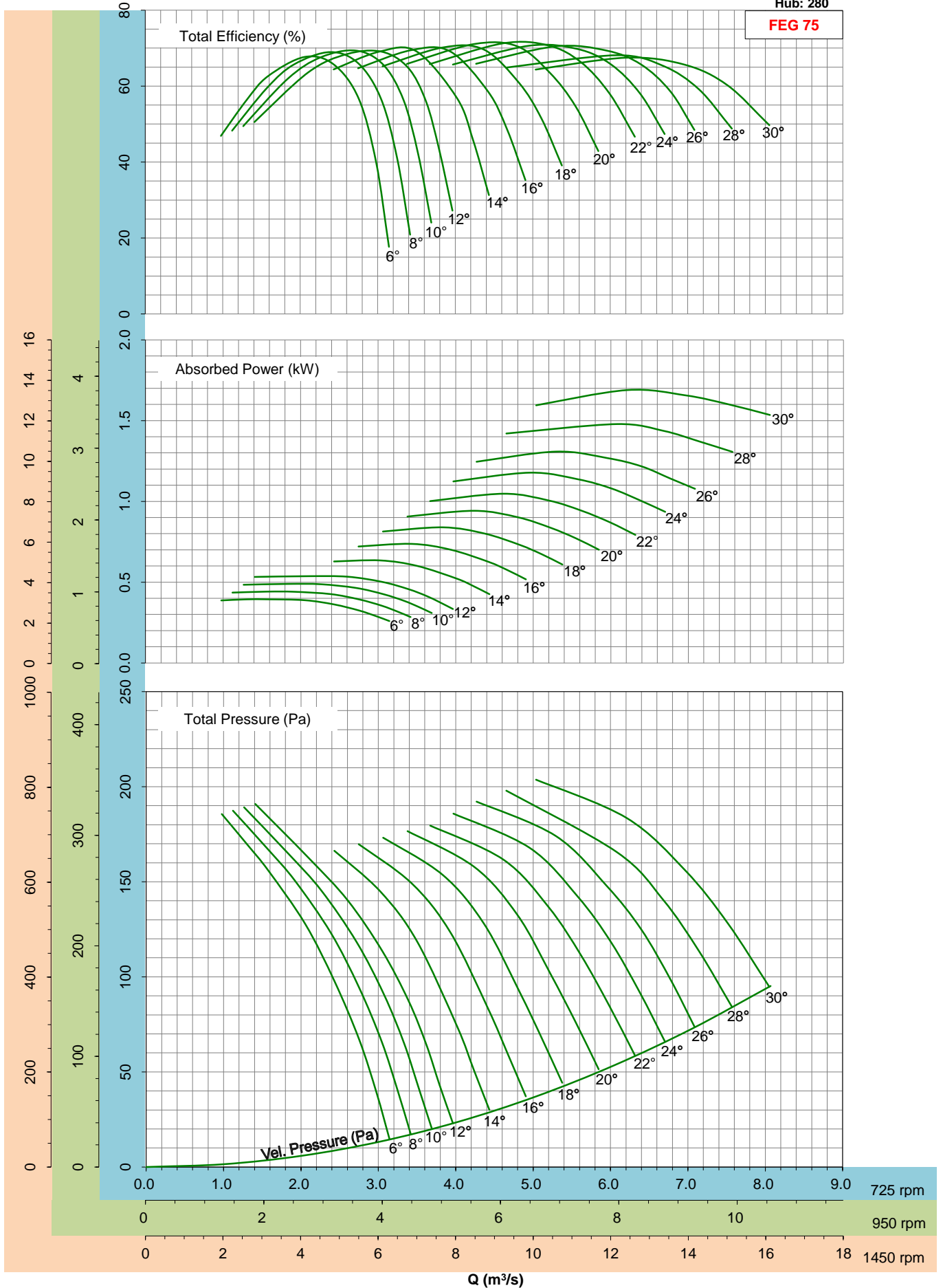

- Performance certified is for installation type D - ducted inlet, ducted outlet. Performance ratings do not include the effects of appurtenances (accessories).

$\rho=1.2\text{kg/m}^3$
Hub: 186

FEG 75

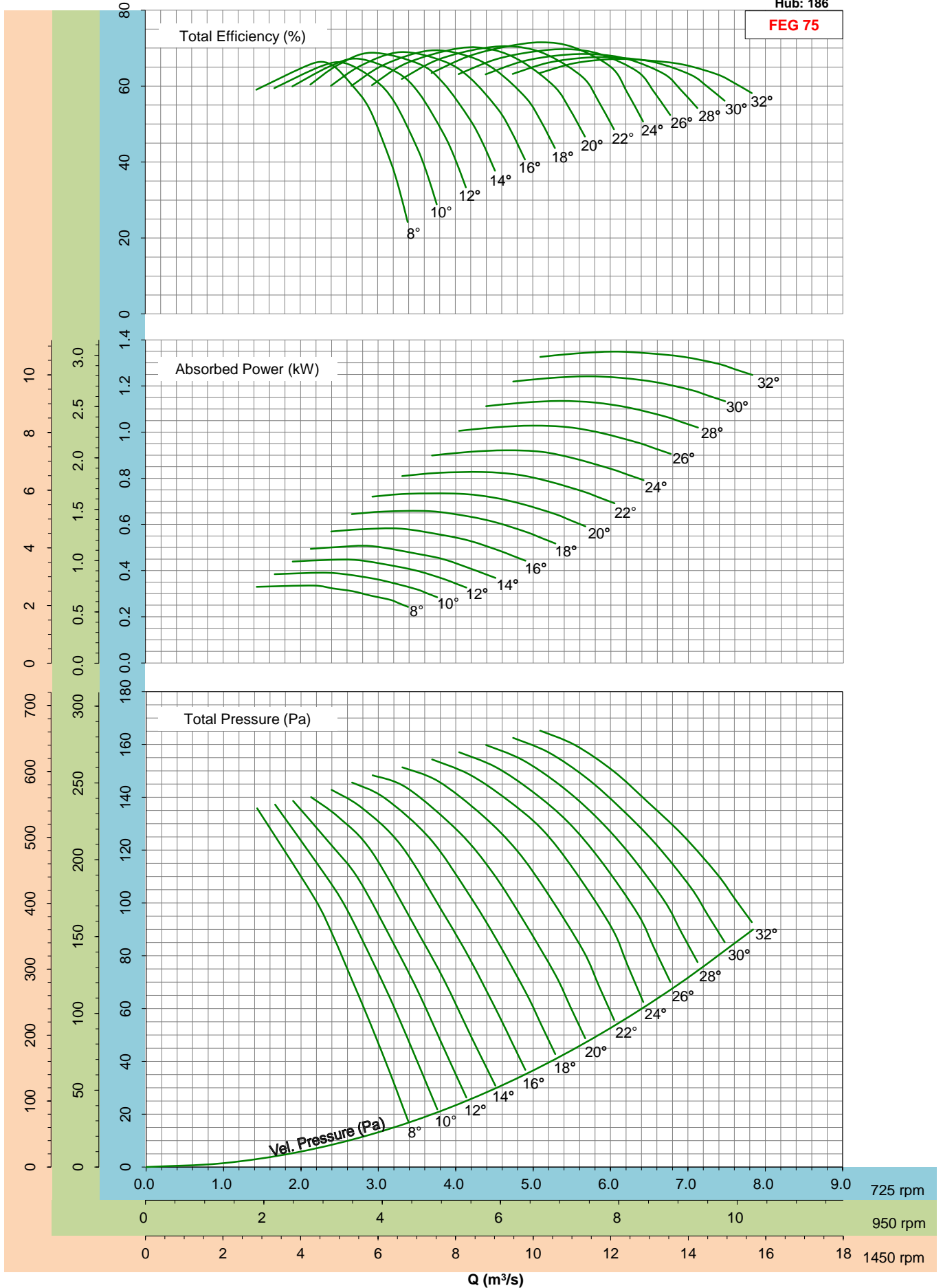

- Performance certified is for installation type D - ducted inlet, ducted outlet. Performance ratings do not include the effects of appurtenances (accessories).

$\rho=1.2\text{kg/m}^3$
Hub: 200

FEG 75

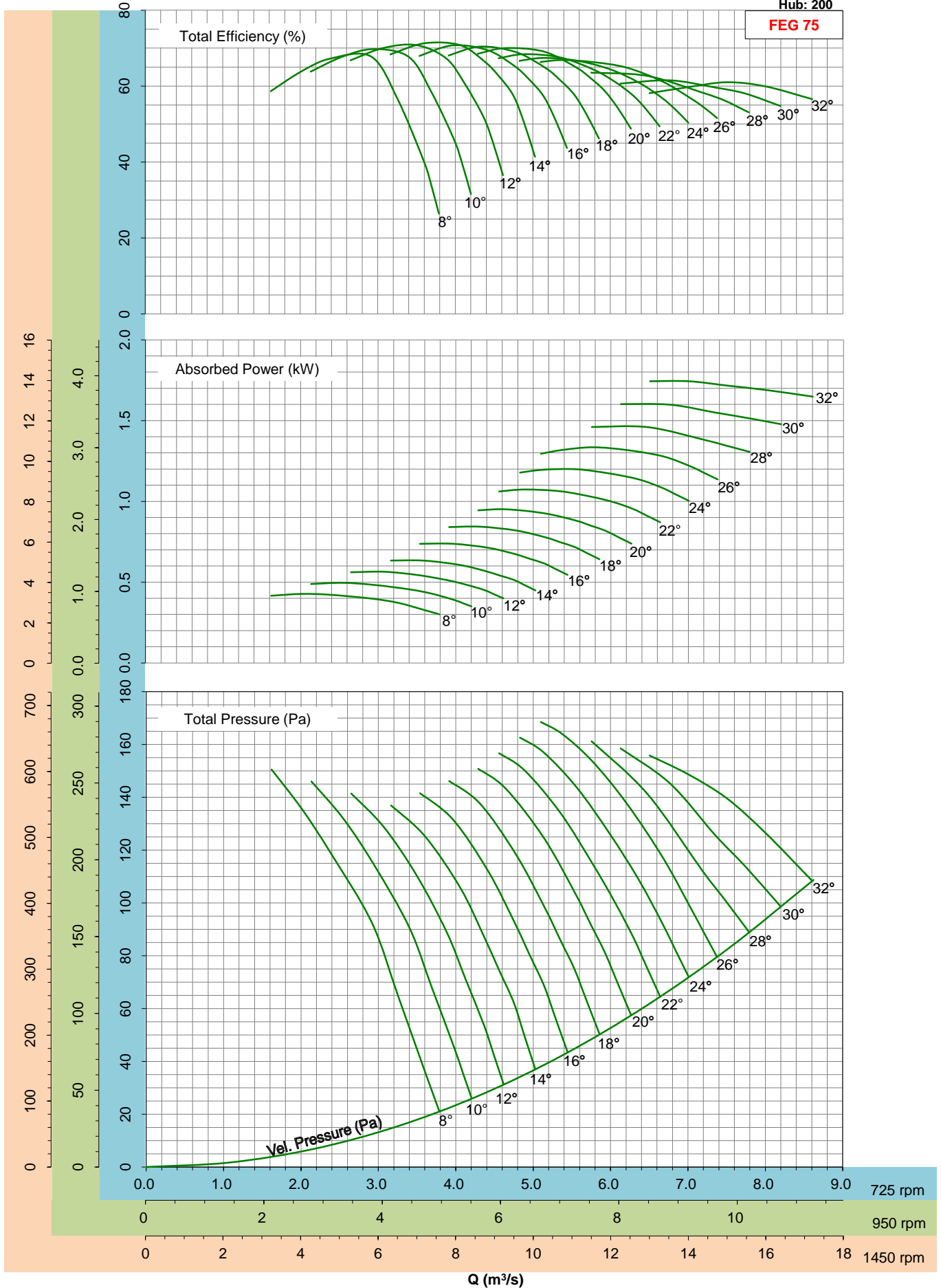

- Performance certified is for installation type D - ducted inlet, ducted outlet. Performance ratings do not include the effects of appurtenances (accessories).

$\rho=1.2\text{kg/m}^3$
Hub: 280

FEG 75

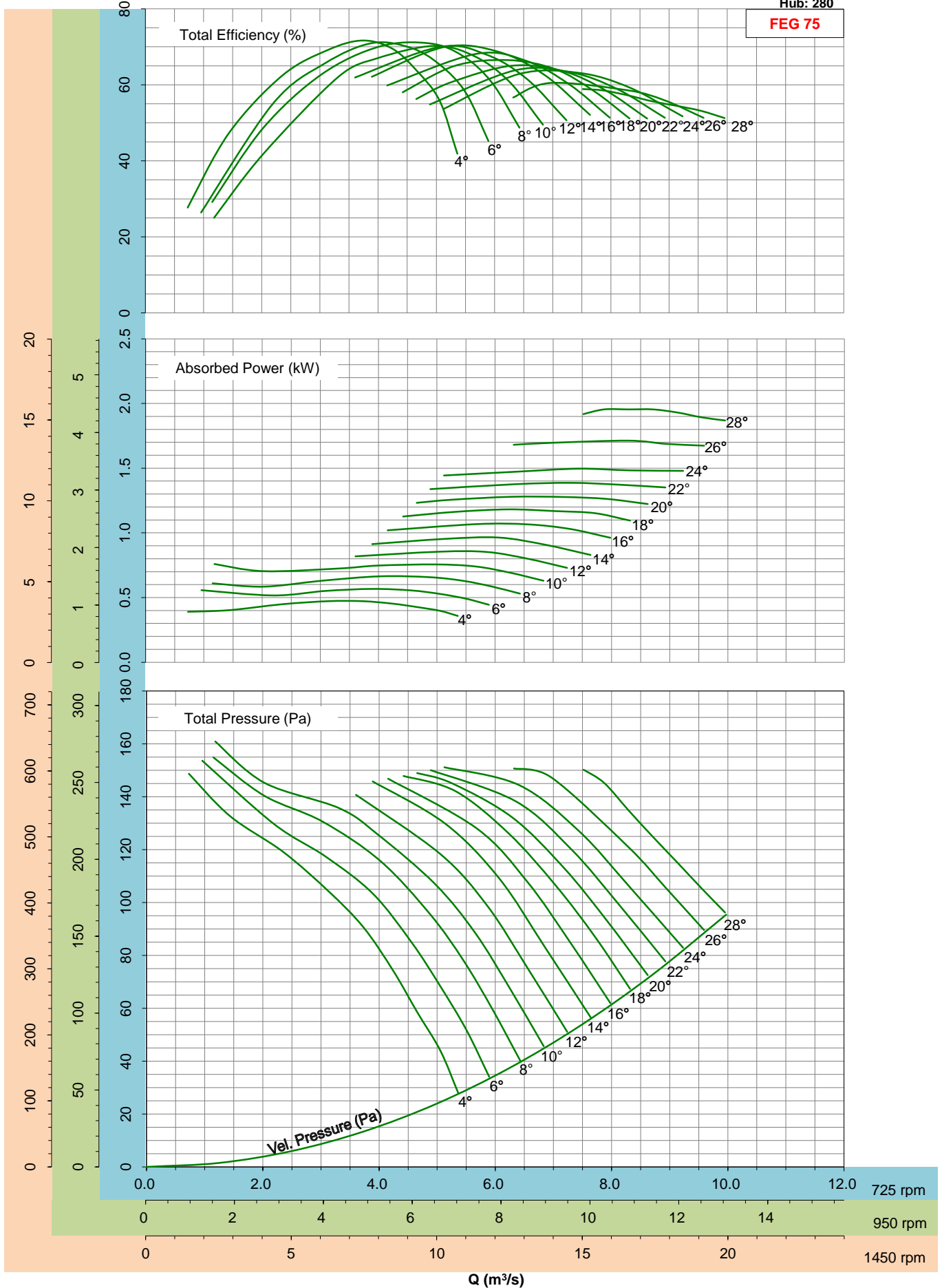

- Performance certified is for installation type D - ducted inlet, ducted outlet. Performance ratings do not include the effects of appurtenances (accessories).

$\rho=1.2\text{kg/m}^3$
Hub: 200

FEG 75

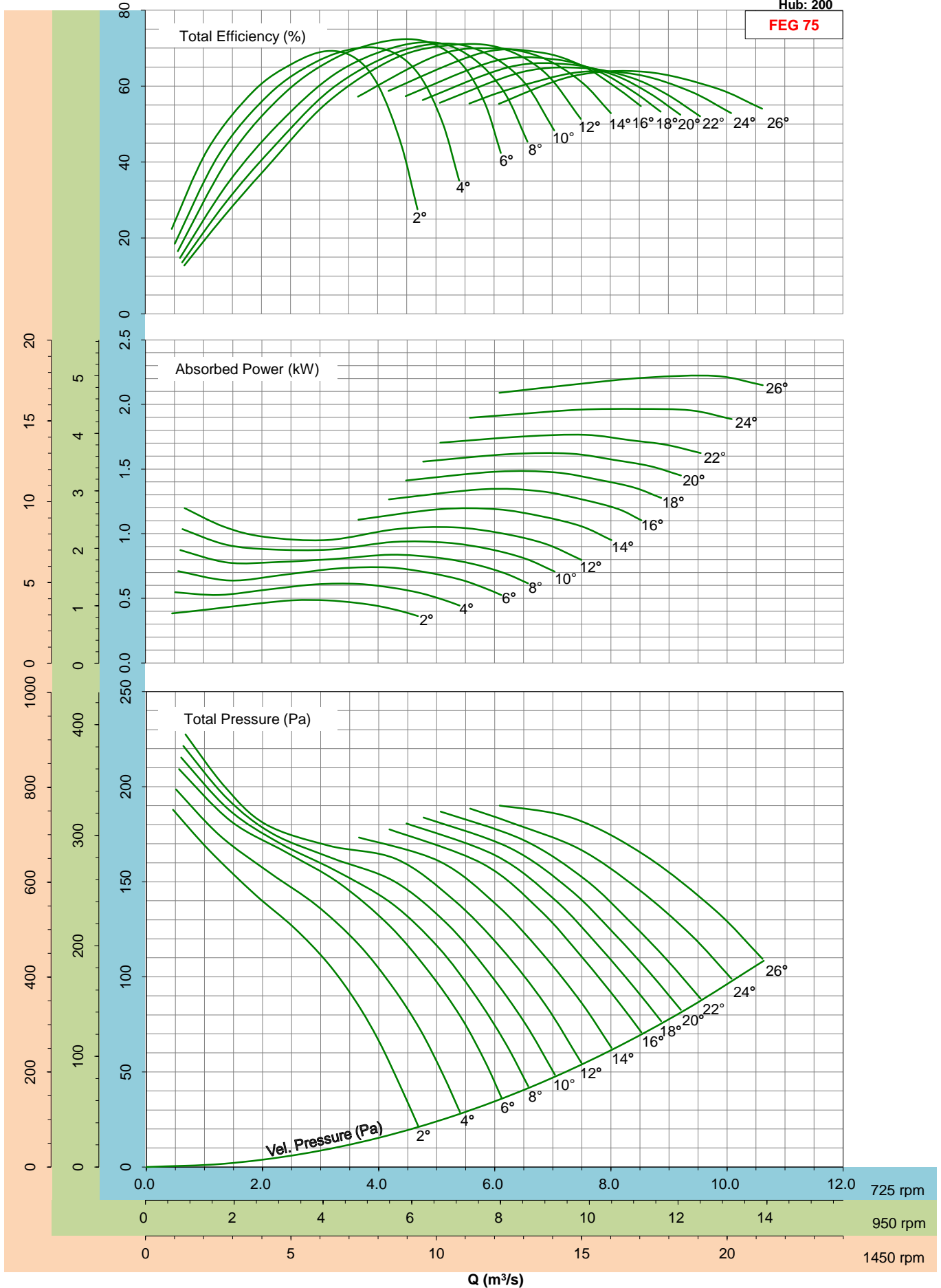

- Performance certified is for installation type D - ducted inlet, ducted outlet. Performance ratings do not include the effects of appurtenances (accessories).

$\rho=1.2\text{kg/m}^3$
Hub: 280

FEG 75

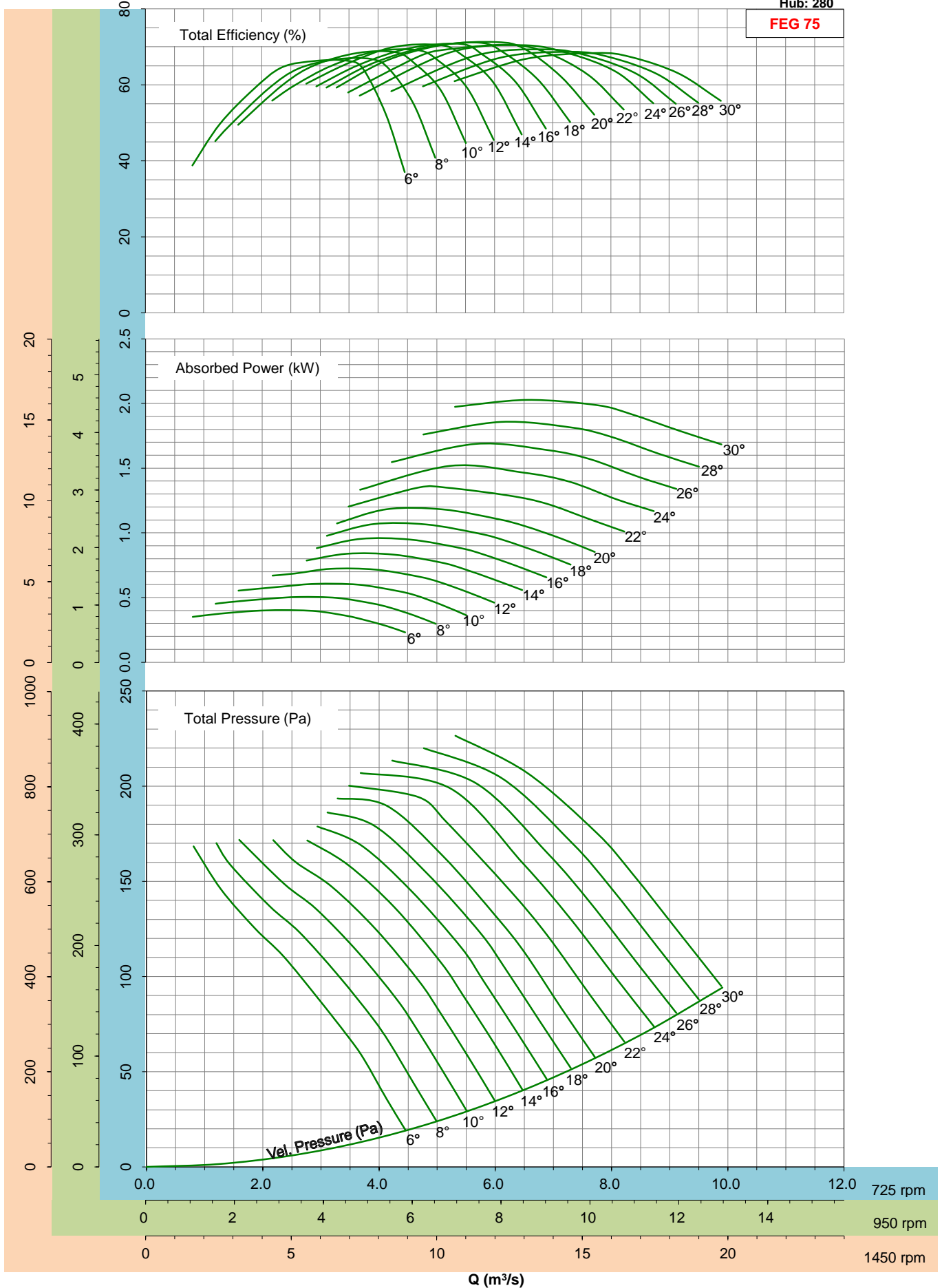

- Performance certified is for installation type D - ducted inlet, ducted outlet. Performance ratings do not include the effects of appurtenances (accessories).

$\rho=1.2\text{kg/m}^3$
Hub: 280

FEG 75

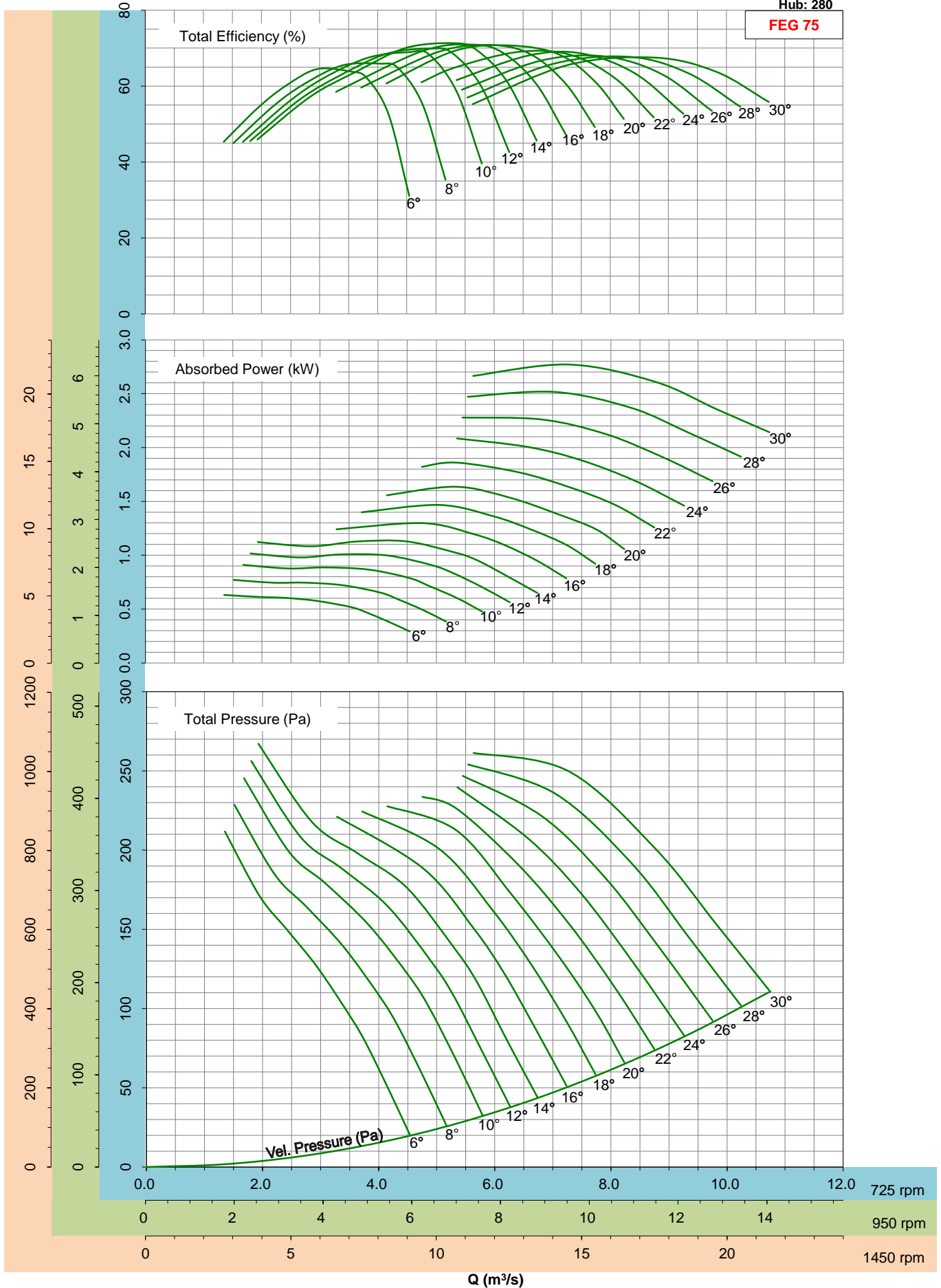

- Performance certified is for installation type D - ducted inlet, ducted outlet. Performance ratings do not include the effects of appurtenances (accessories).

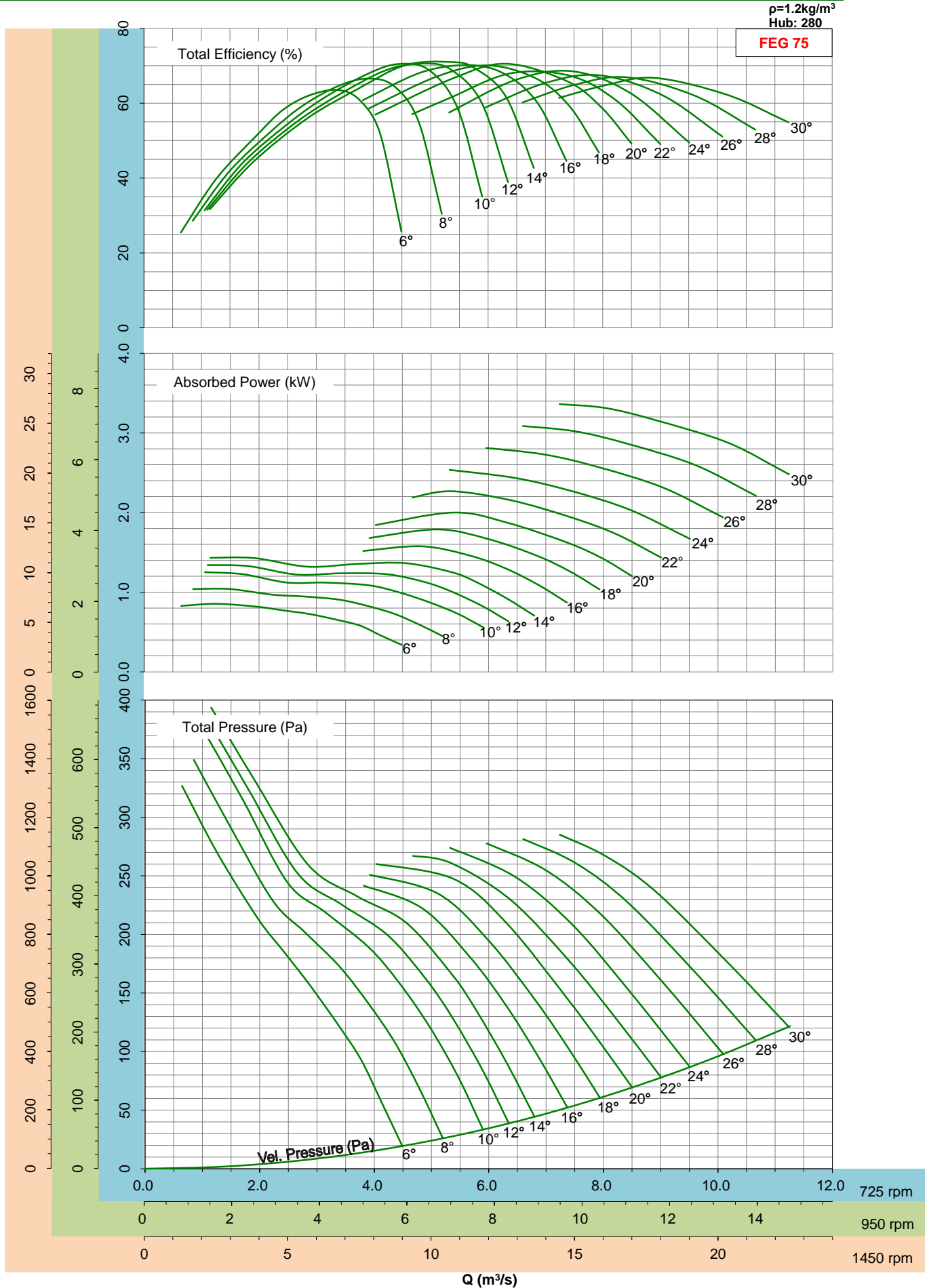

- Performance certified is for installation type D - ducted inlet, ducted outlet. Performance ratings do not include the effects of appurtenances (accessories).

$\rho=1.2\text{kg/m}^3$
Hub: 315

FEG 75

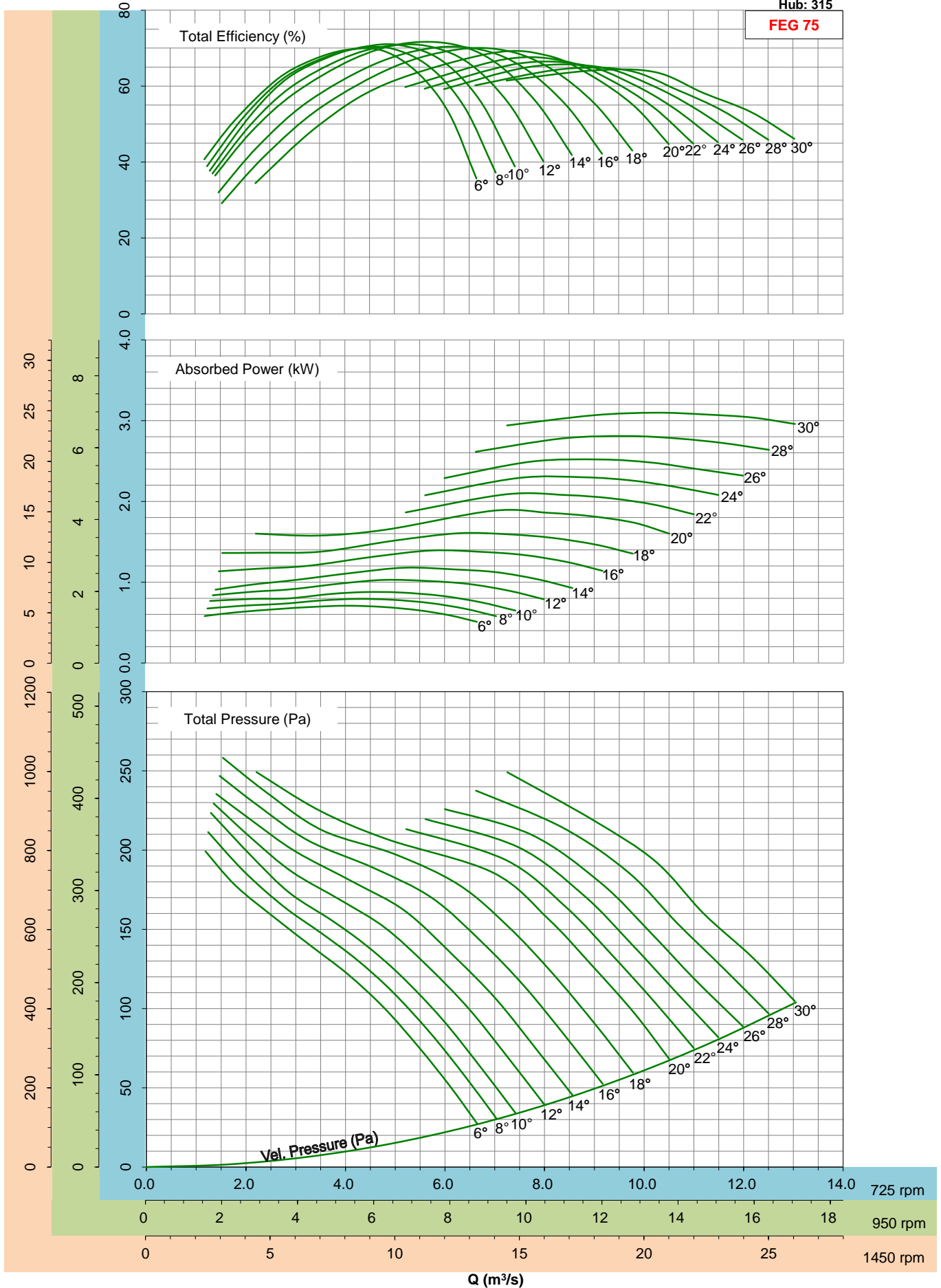

- Performance certified is for installation type D - ducted inlet, ducted outlet. Performance ratings do not include the effects of appurtenances (accessories).

$\rho=1.2\text{kg/m}^3$
Hub: 315

FEG 75

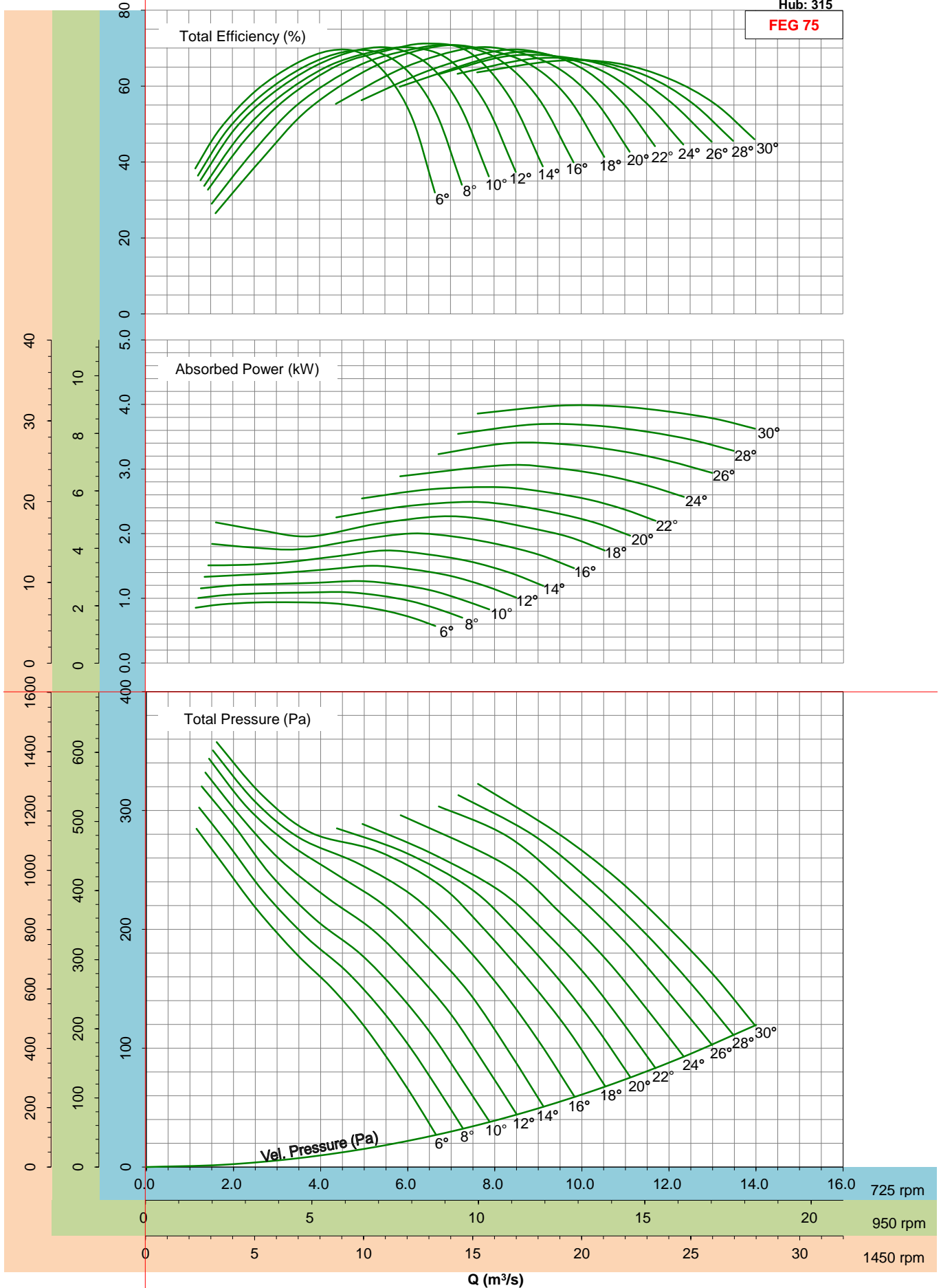

- Performance certified is for installation type D - ducted inlet, ducted outlet. Performance ratings do not include the effects of appurtenances (accessories).

$\rho=1.2\text{kg/m}^3$
Hub: 315

FEG 75

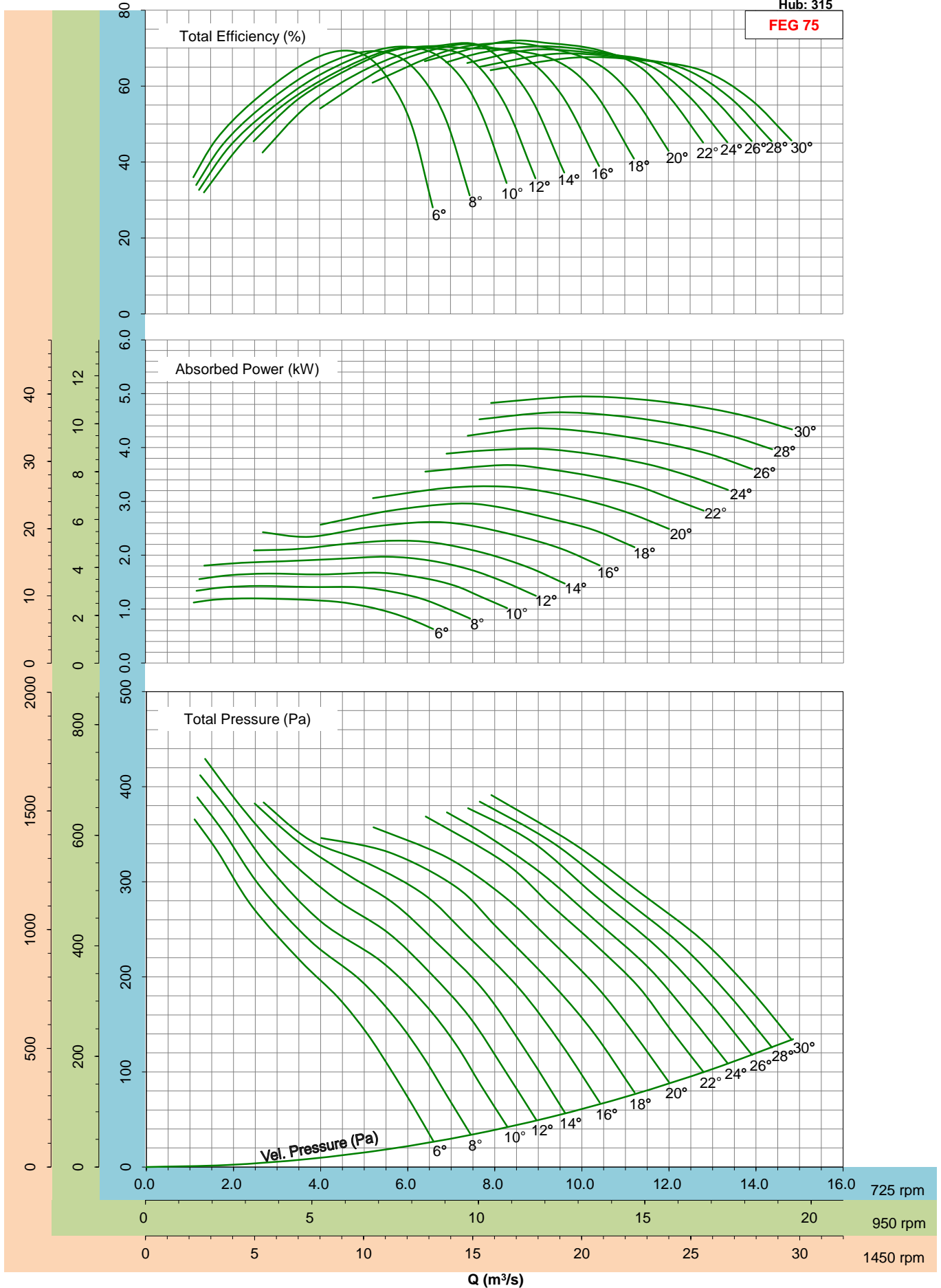

- Performance certified is for installation type D - ducted inlet, ducted outlet. Performance ratings do not include the effects of appurtenances (accessories).

$\rho=1.2\text{kg/m}^3$
Hub: 315

FEG 75

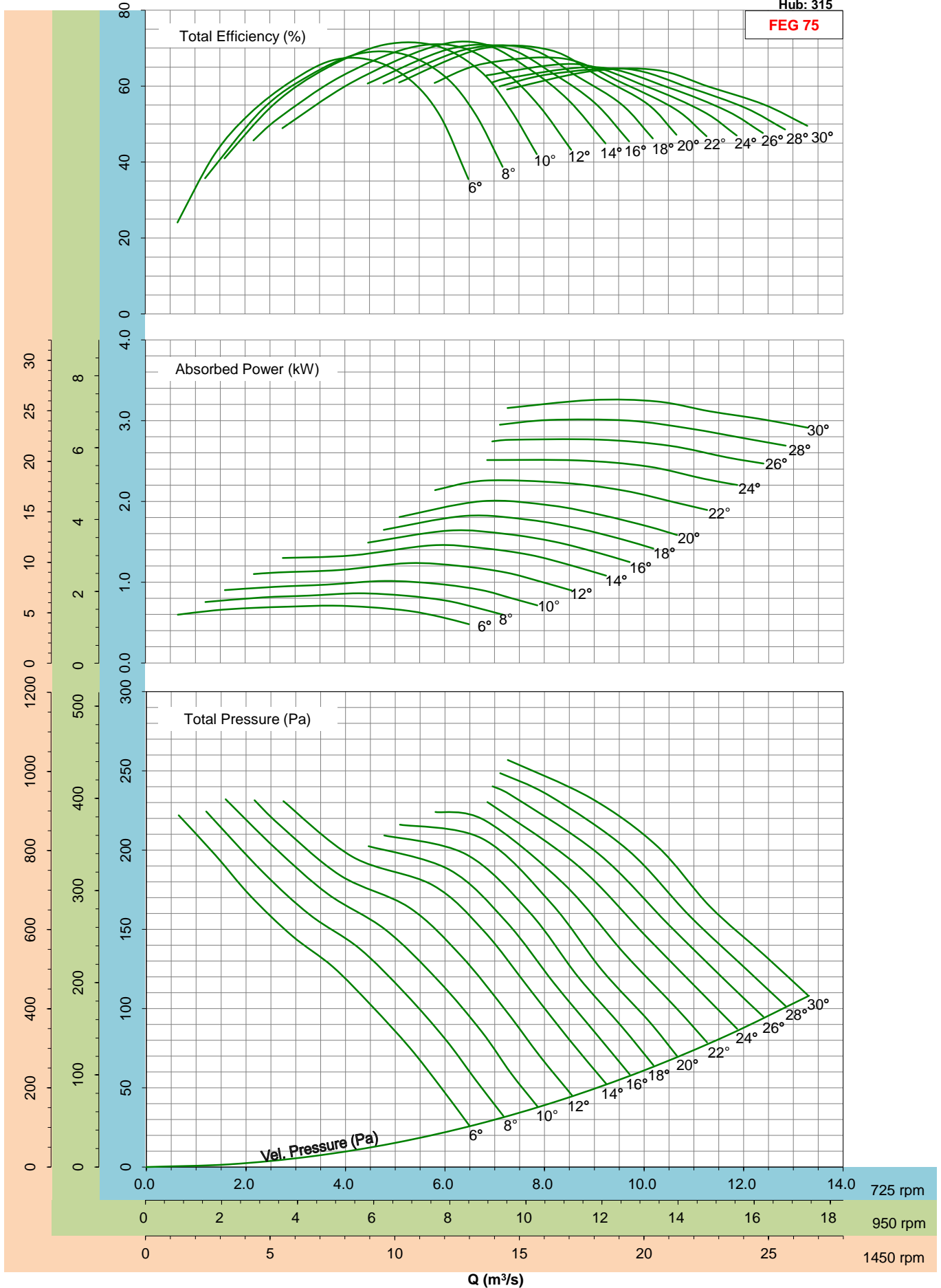

- Performance certified is for installation type D - ducted inlet, ducted outlet. Performance ratings do not include the effects of appurtenances (accessories).

$\rho=1.2\text{kg/m}^3$
Hub: 315

FEG 75

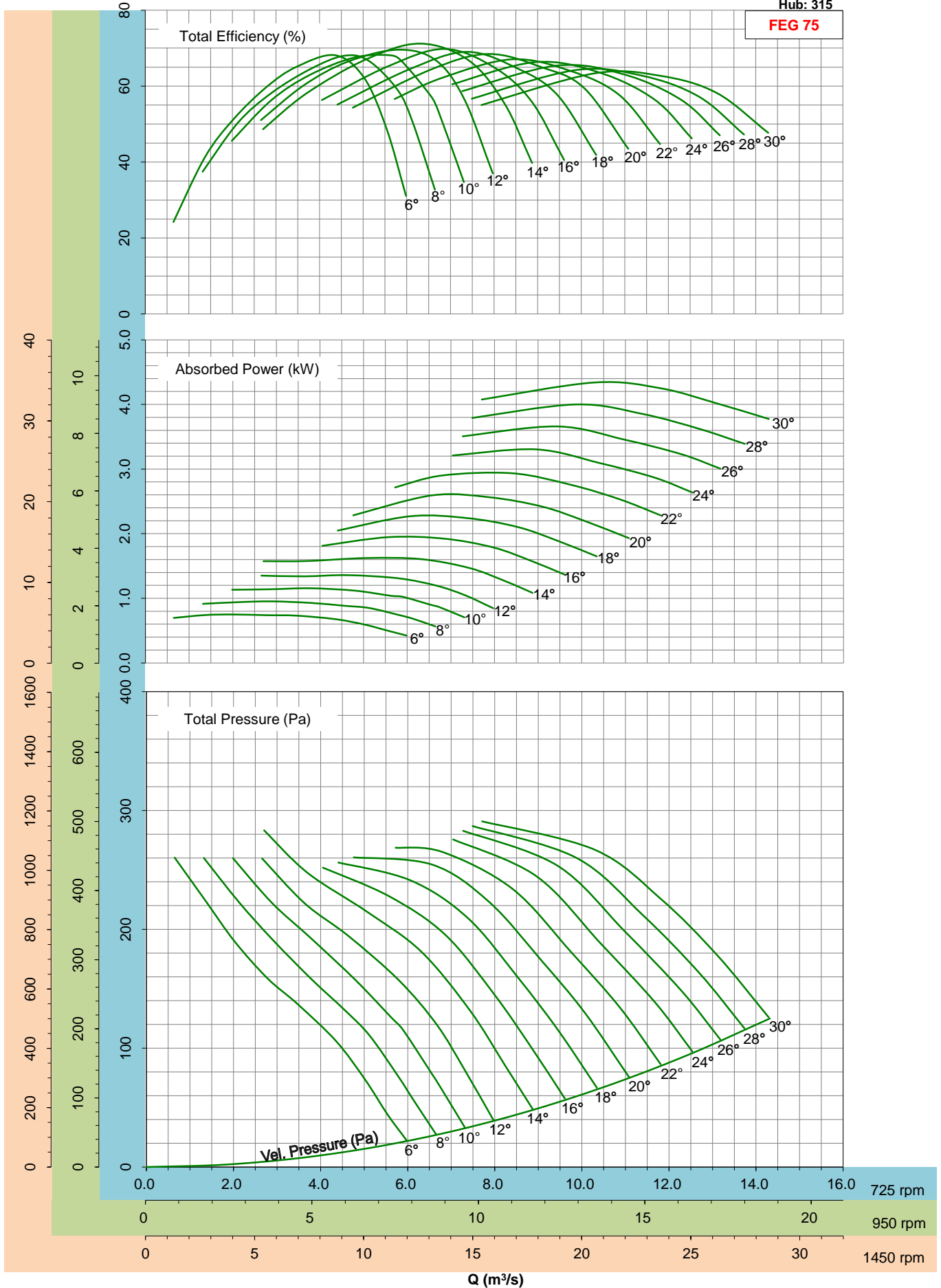

- Performance certified is for installation type D - ducted inlet, ducted outlet. Performance ratings do not include the effects of appurtenances (accessories).

$\rho=1.2\text{kg/m}^3$
Hub: 315

FEG 75

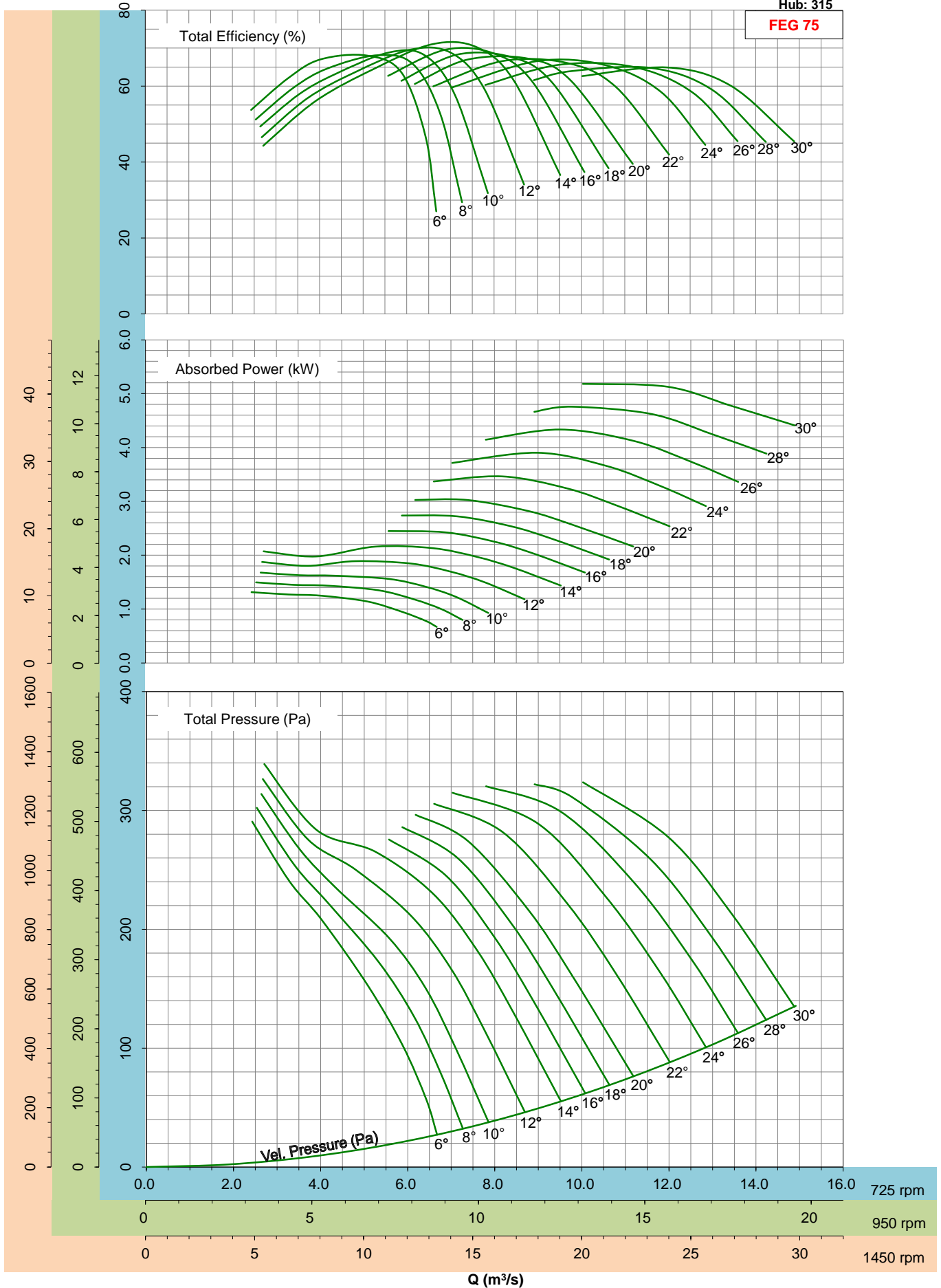

- Performance certified is for installation type D - ducted inlet, ducted outlet. Performance ratings do not include the effects of appurtenances (accessories).

$\rho=1.2\text{kg/m}^3$
Hub: 353

FEG 75

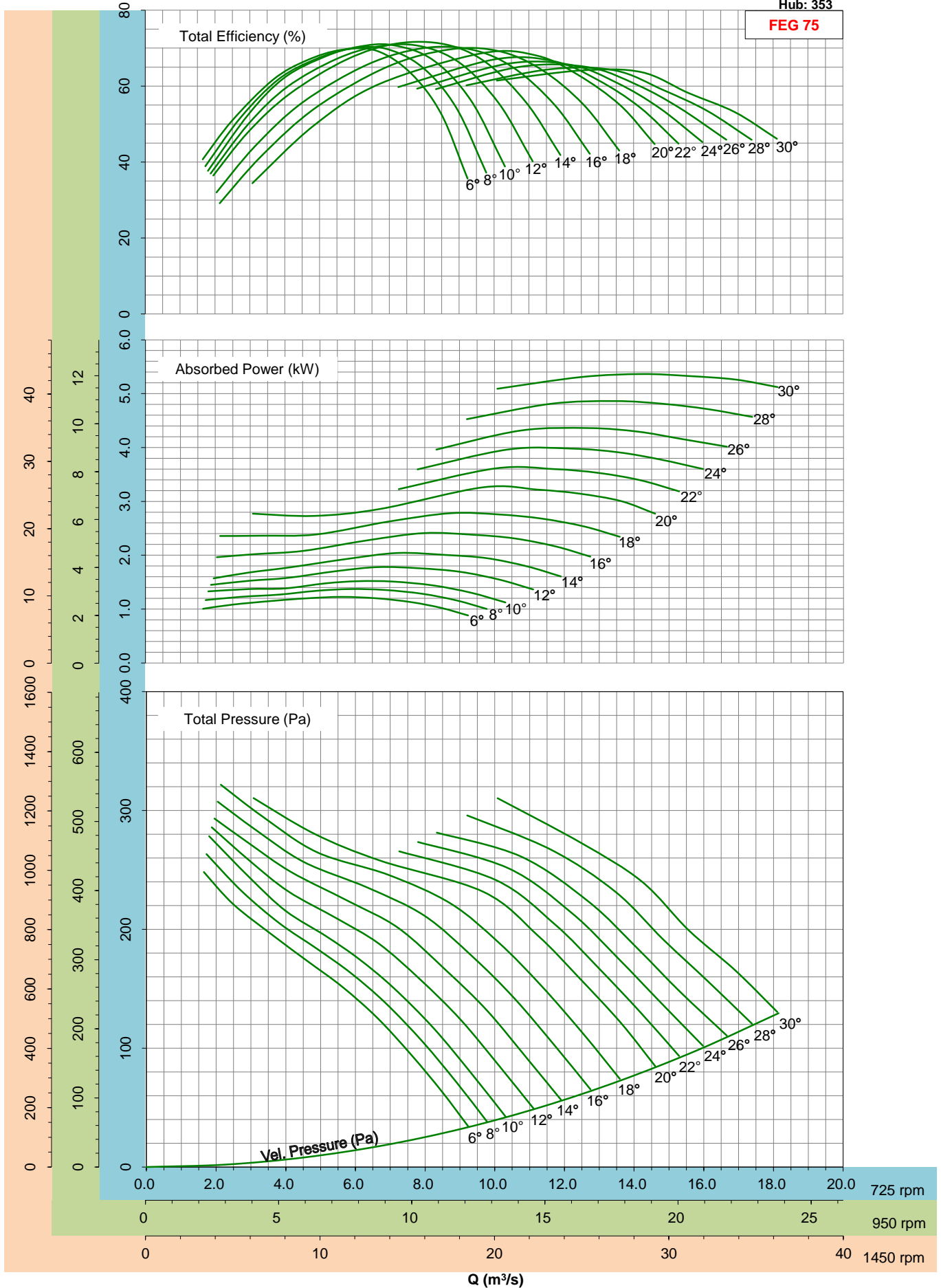

- Performance certified is for installation type D - ducted inlet, ducted outlet. Performance ratings do not include the effects of appurtenances (accessories).

- Please consult the nearest Kruger office for fan selection at 1450rpm.

$\rho=1.2\text{kg/m}^3$
Hub: 353

FEG 75

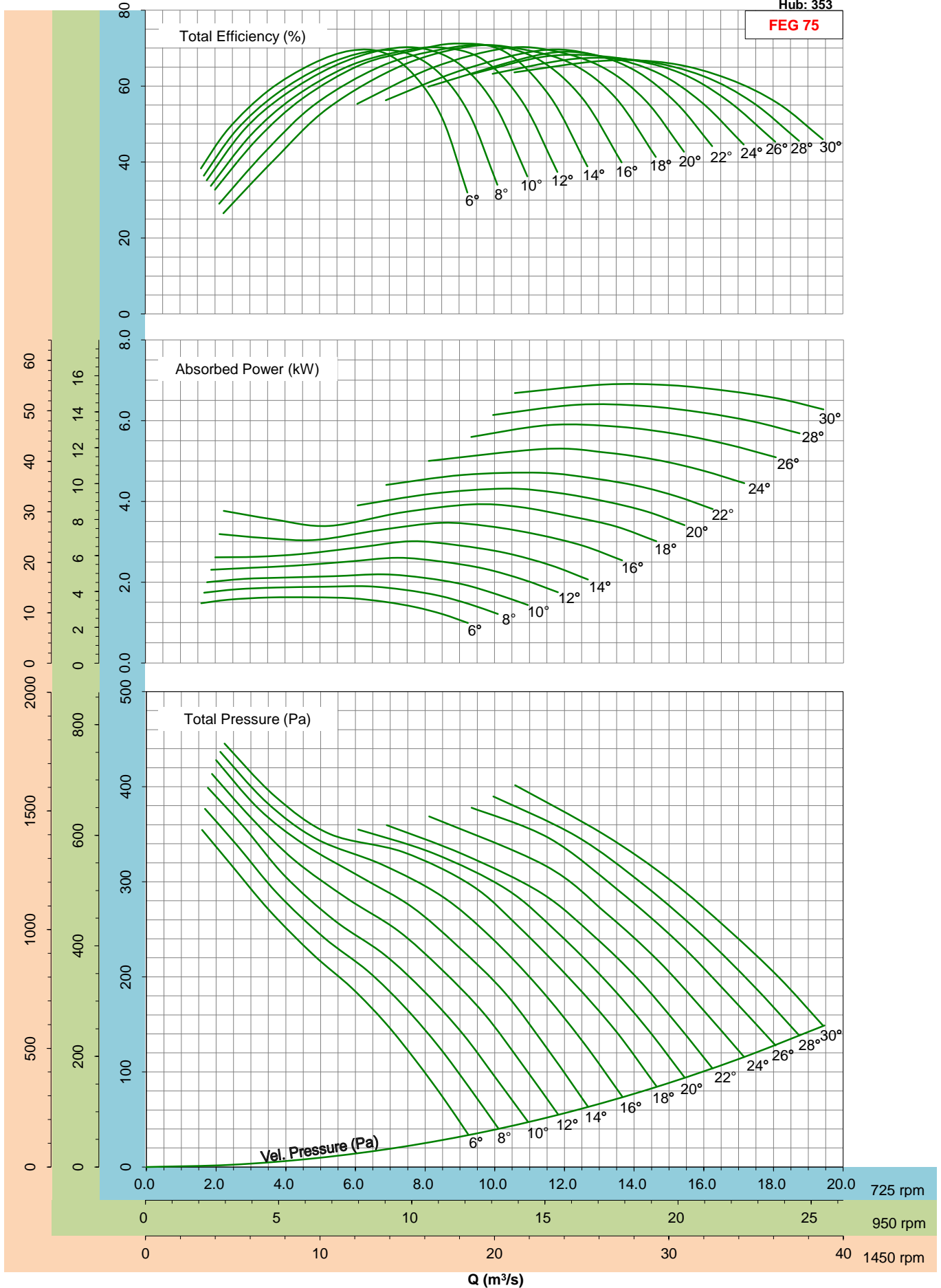

- Performance certified is for installation type D - ducted inlet, ducted outlet. Performance ratings do not include the effects of appurtenances (accessories).

- Please consult the nearest Kruger office for fan selection at 1450rpm.

$\rho=1.2\text{kg/m}^3$
Hub: 353

FEG 75

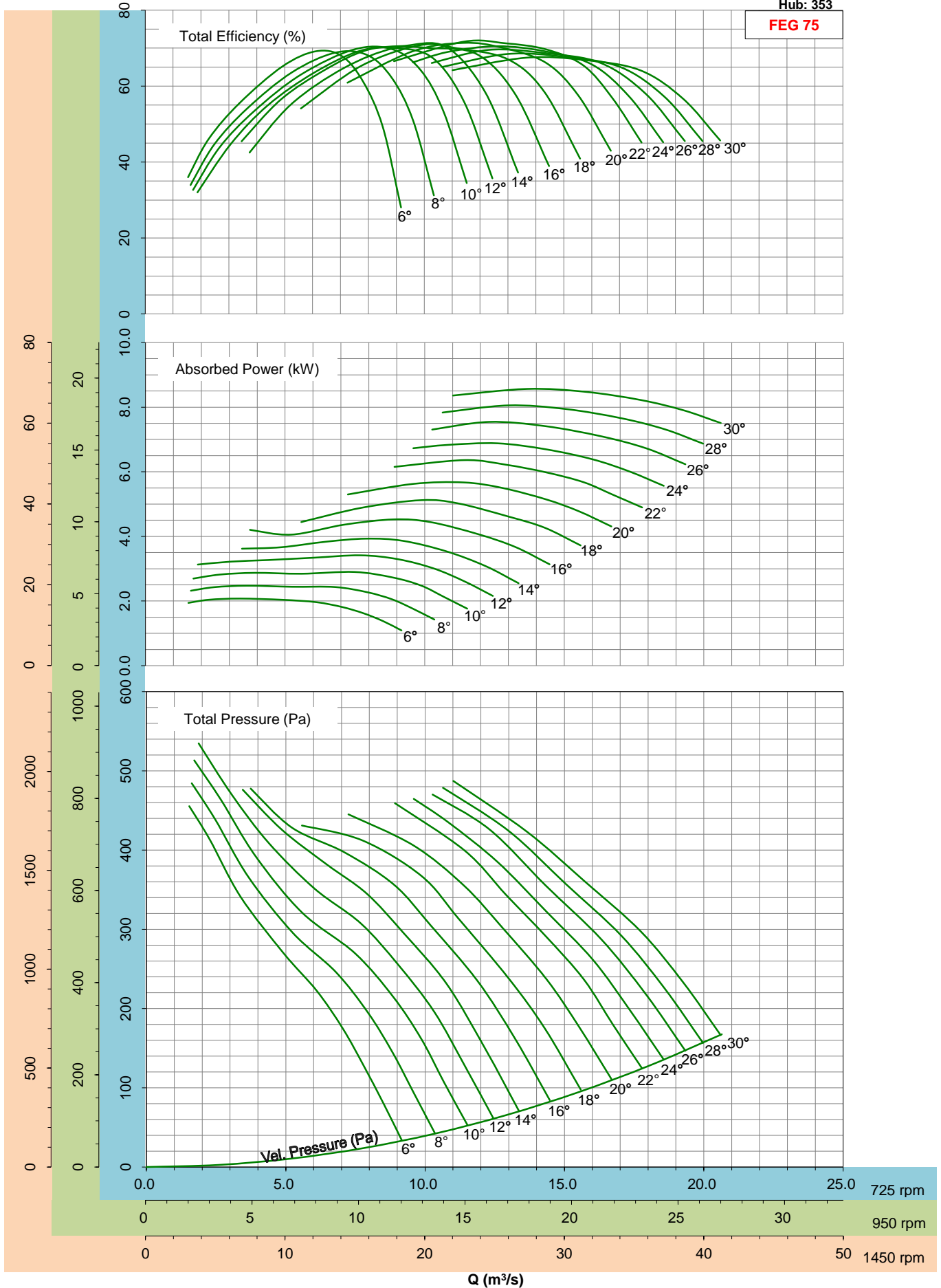

- Performance certified is for installation type D - ducted inlet, ducted outlet. Performance ratings do not include the effects of appurtenances (accessories).

- Please consult the nearest Kruger office for fan selection at 1450rpm.

$\rho=1.2\text{kg/m}^3$
Hub: 353

FEG 75

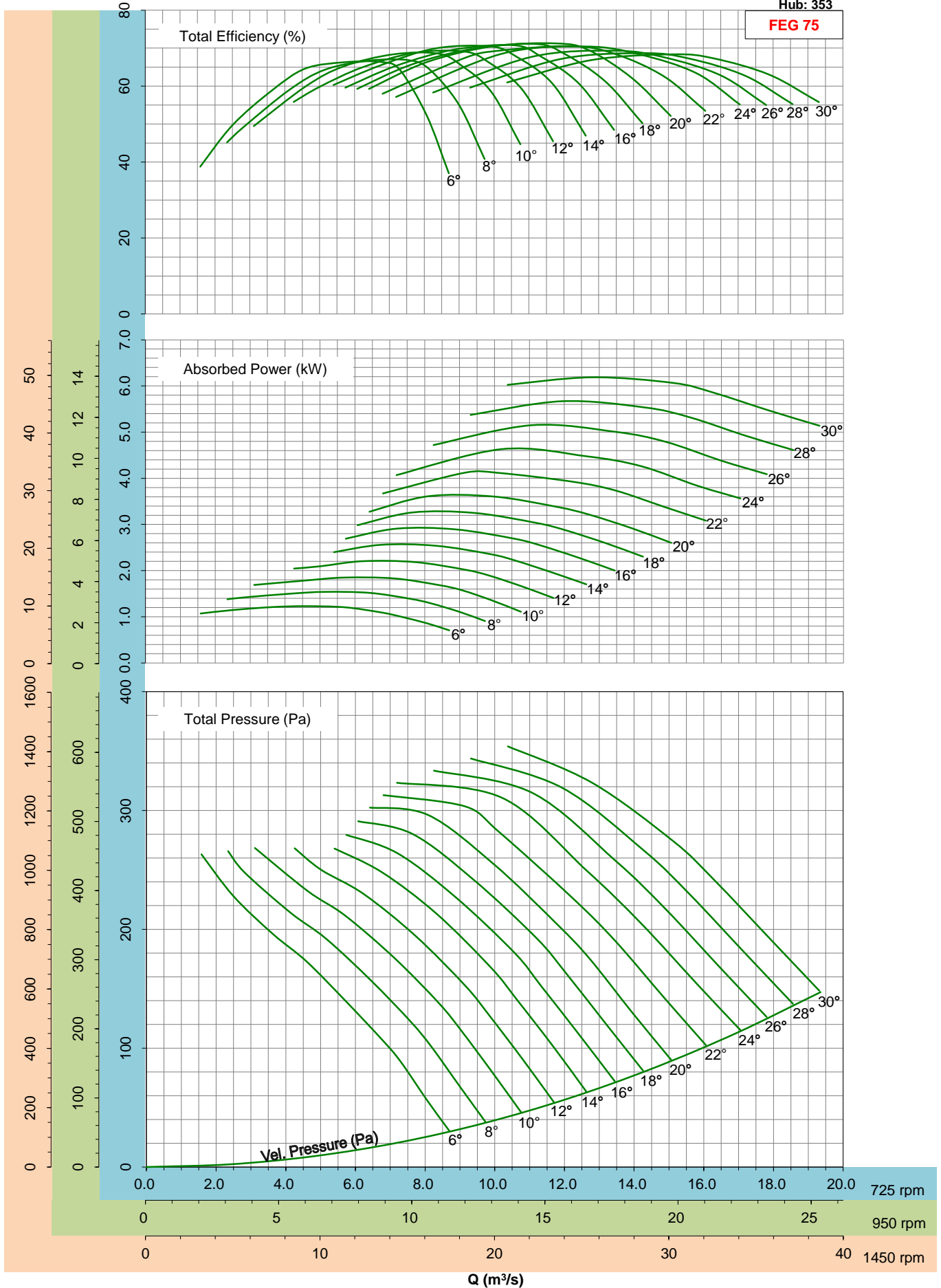

- Performance certified is for installation type D - ducted inlet, ducted outlet. Performance ratings do not include the effects of appurtenances (accessories).

- Please consult the nearest Kruger office for fan selection at 1450rpm.

$\rho=1.2\text{kg/m}^3$
Hub: 353

FEG 75

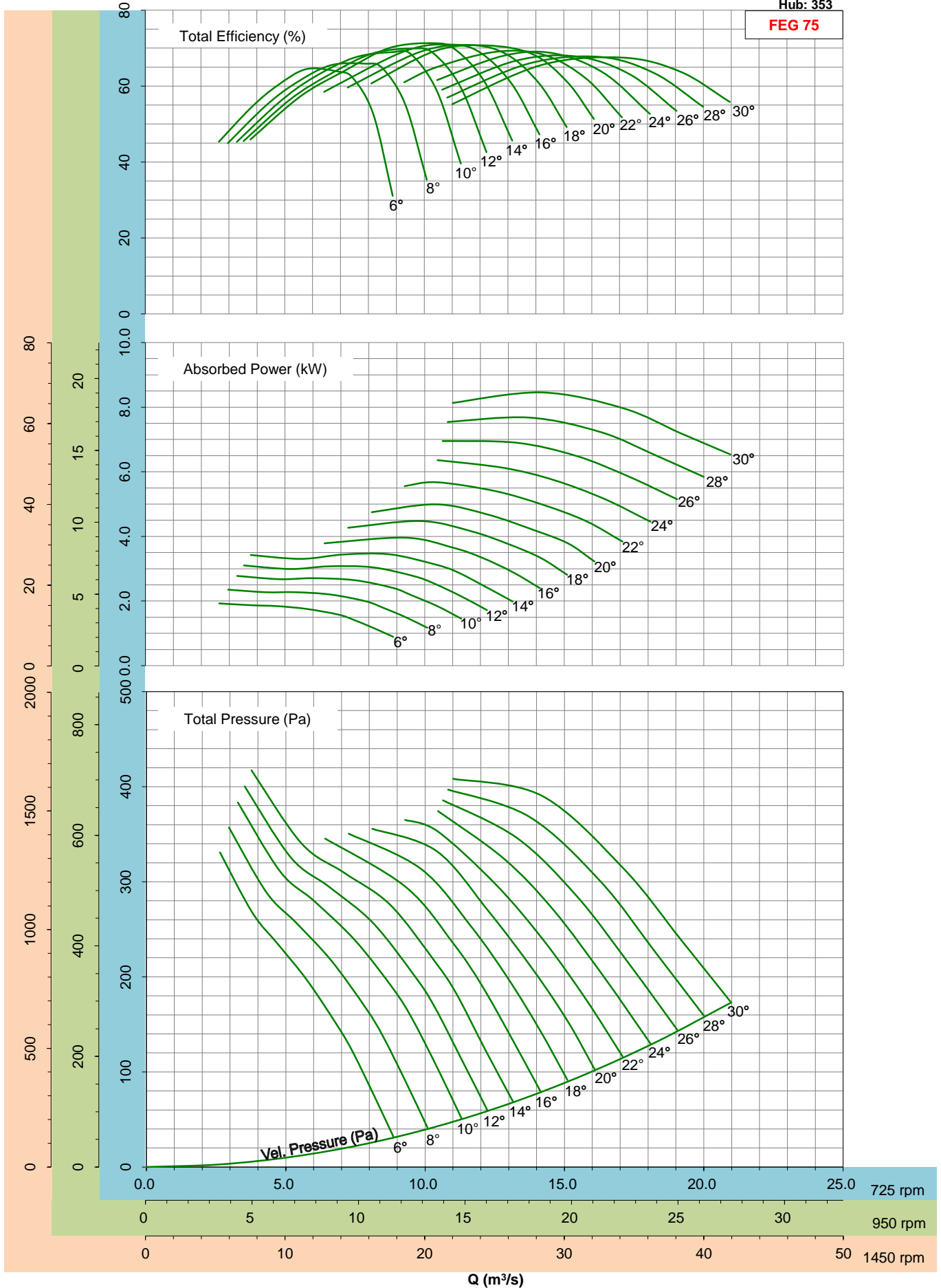

- Performance certified is for installation type D - ducted inlet, ducted outlet. Performance ratings do not include the effects of appurtenances (accessories).

- Please consult the nearest Kruger office for fan selection at 1450rpm.

$\rho=1.2\text{kg/m}^3$
Hub: 353

FEG 75

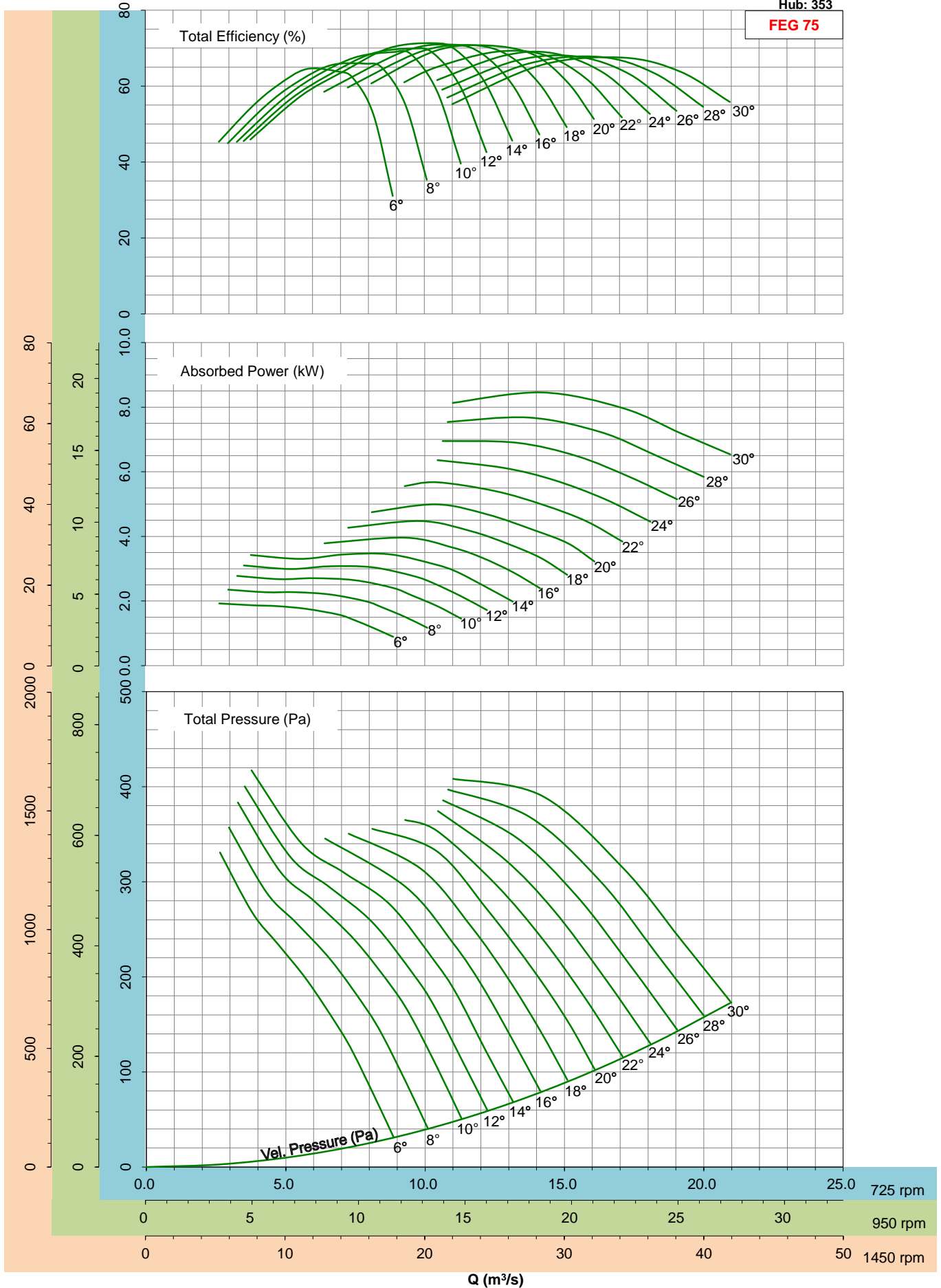

- Performance certified is for installation type D - ducted inlet, ducted outlet. Performance ratings do not include the effects of appurtenances (accessories).

- Please consult the nearest Kruger office for fan selection at 1450rpm.

$\rho=1.2\text{kg/m}^3$
Hub: 397

FEG 75

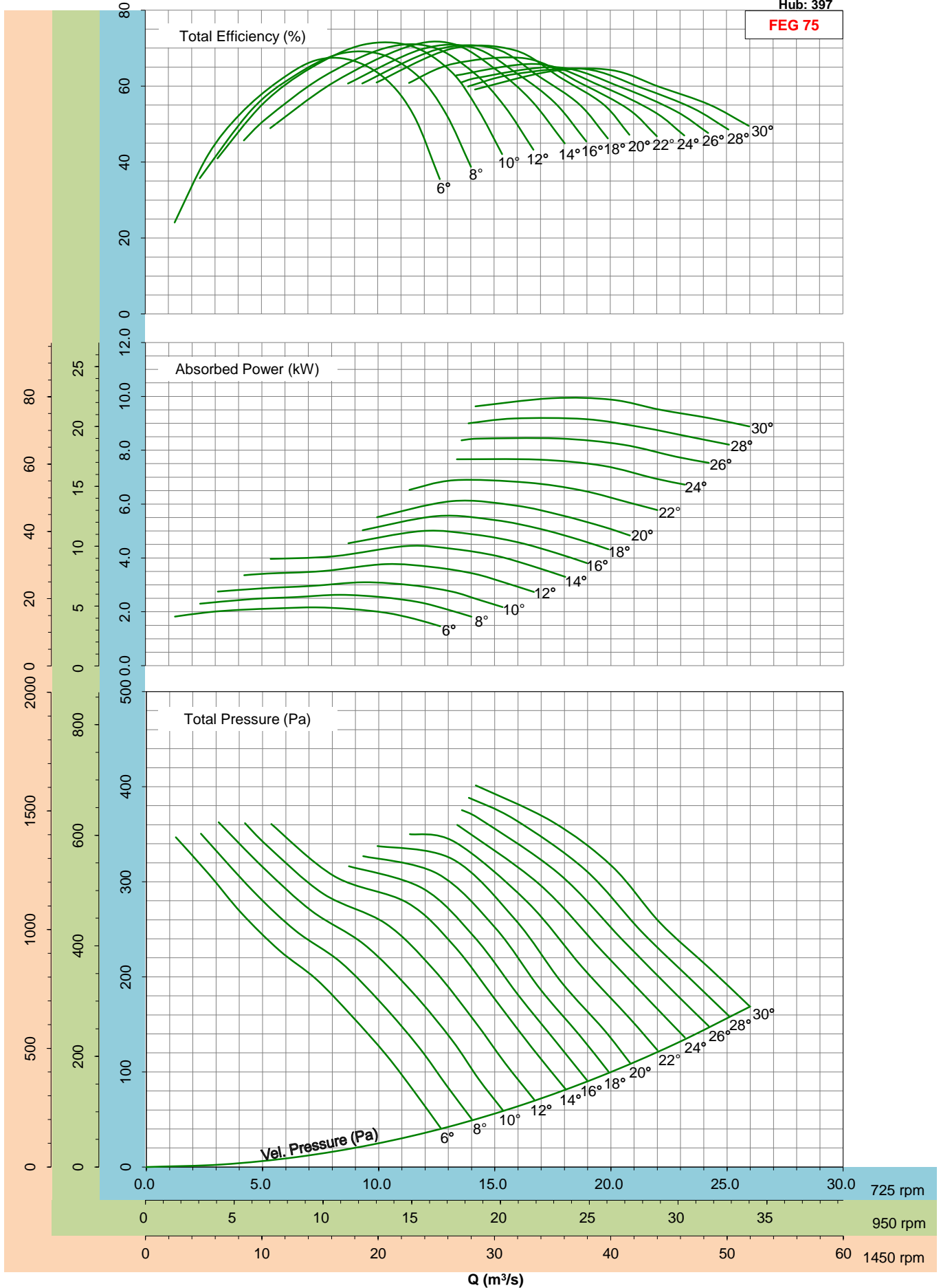

- Performance certified is for installation type D - ducted inlet, ducted outlet. Performance ratings do not include the effects of appurtenances (accessories).

- Please consult the nearest Kruger office for fan selection at 1450rpm.

$\rho=1.2\text{kg/m}^3$
Hub: 397

FEG 75

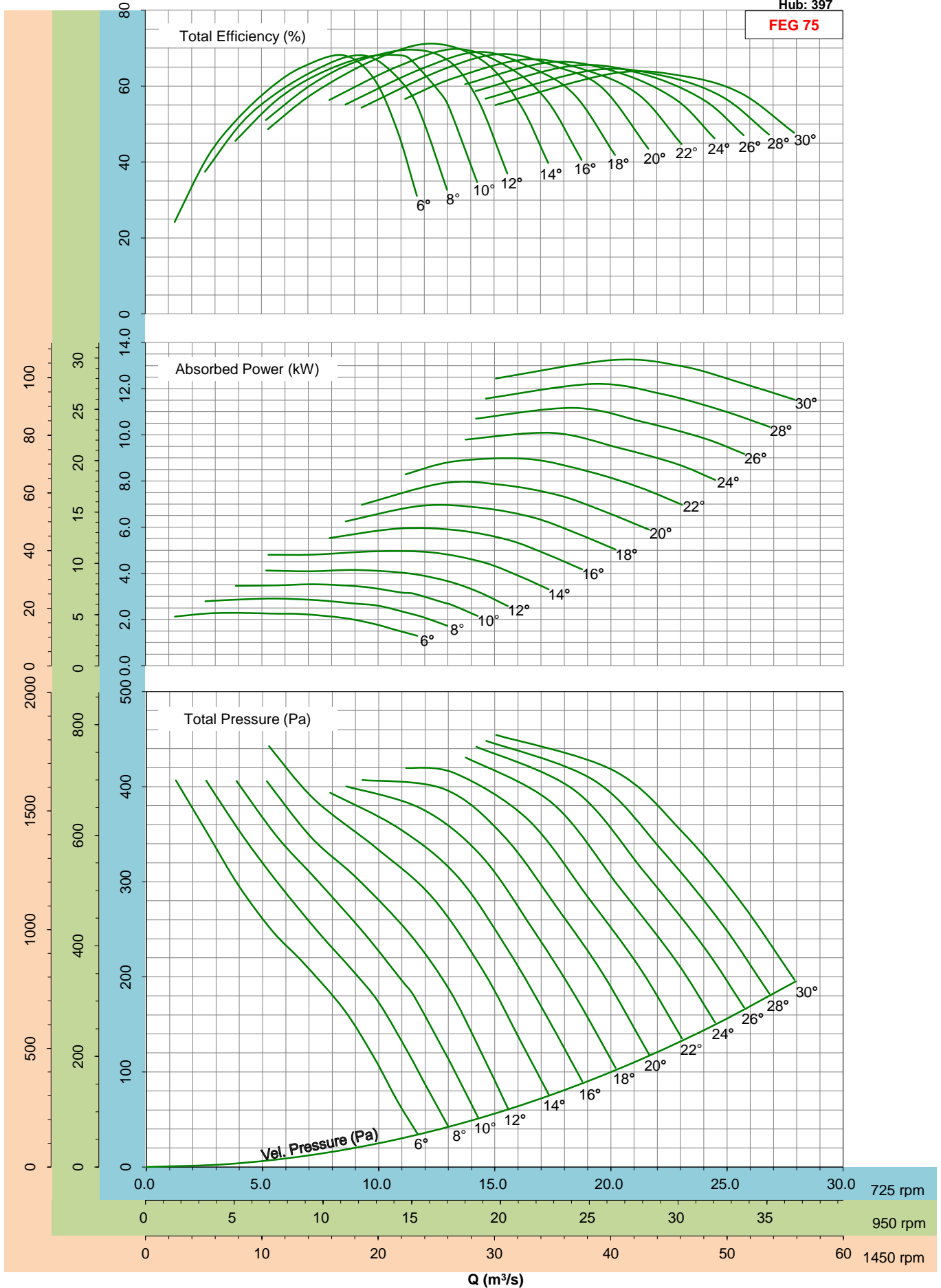

- Performance certified is for installation type D - ducted inlet, ducted outlet. Performance ratings do not include the effects of appurtenances (accessories).

- Please consult the nearest Kruger office for fan selection at 1450rpm.

$\rho=1.2\text{kg/m}^3$
Hub: 397

FEG 75

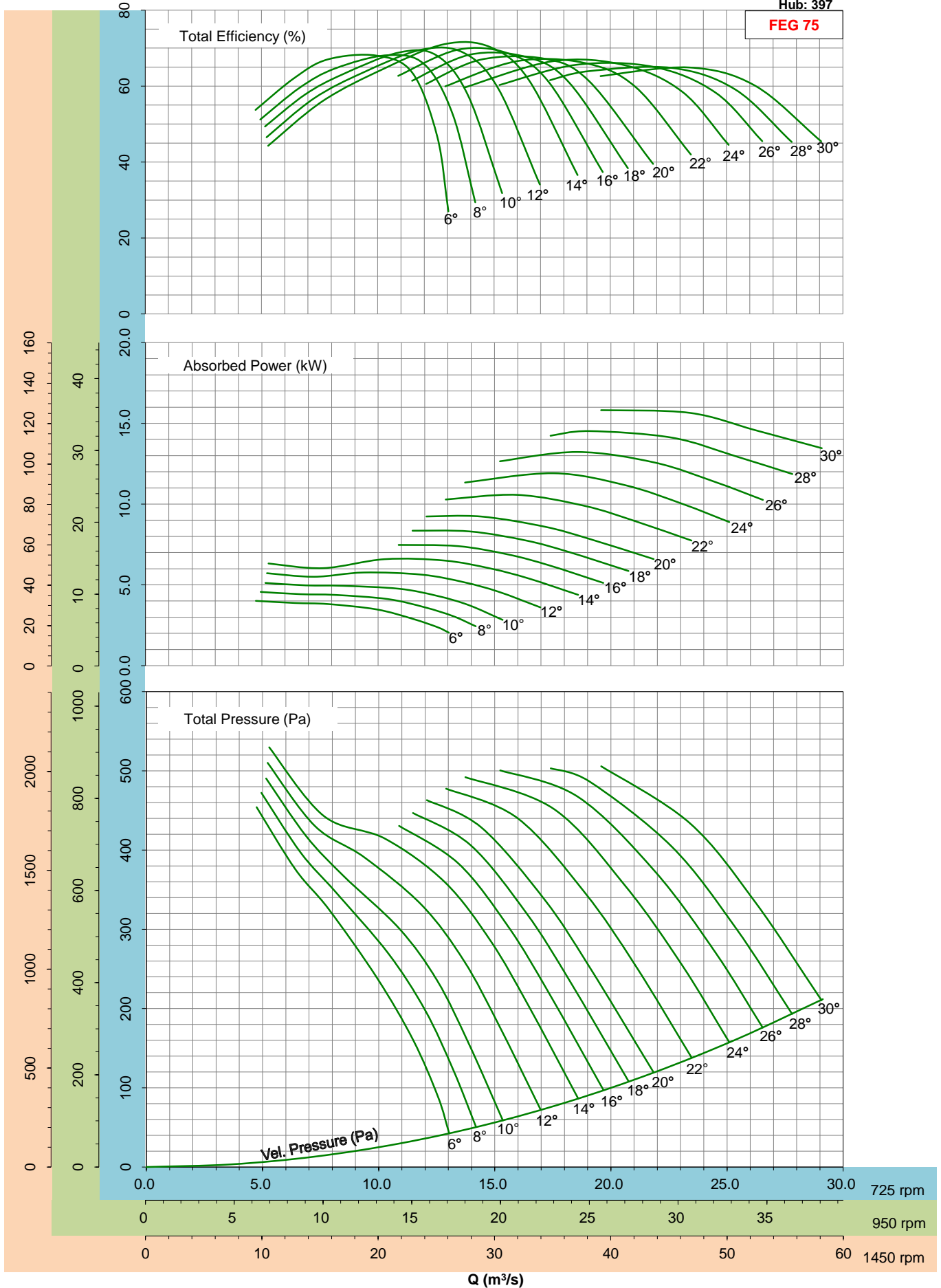

- Performance certified is for installation type D - ducted inlet, ducted outlet. Performance ratings do not include the effects of appurtenances (accessories).

- Please consult the nearest Kruger office for fan selection at 1450rpm.

$\rho=1.2\text{kg/m}^3$
Hub: 450

FEG 75

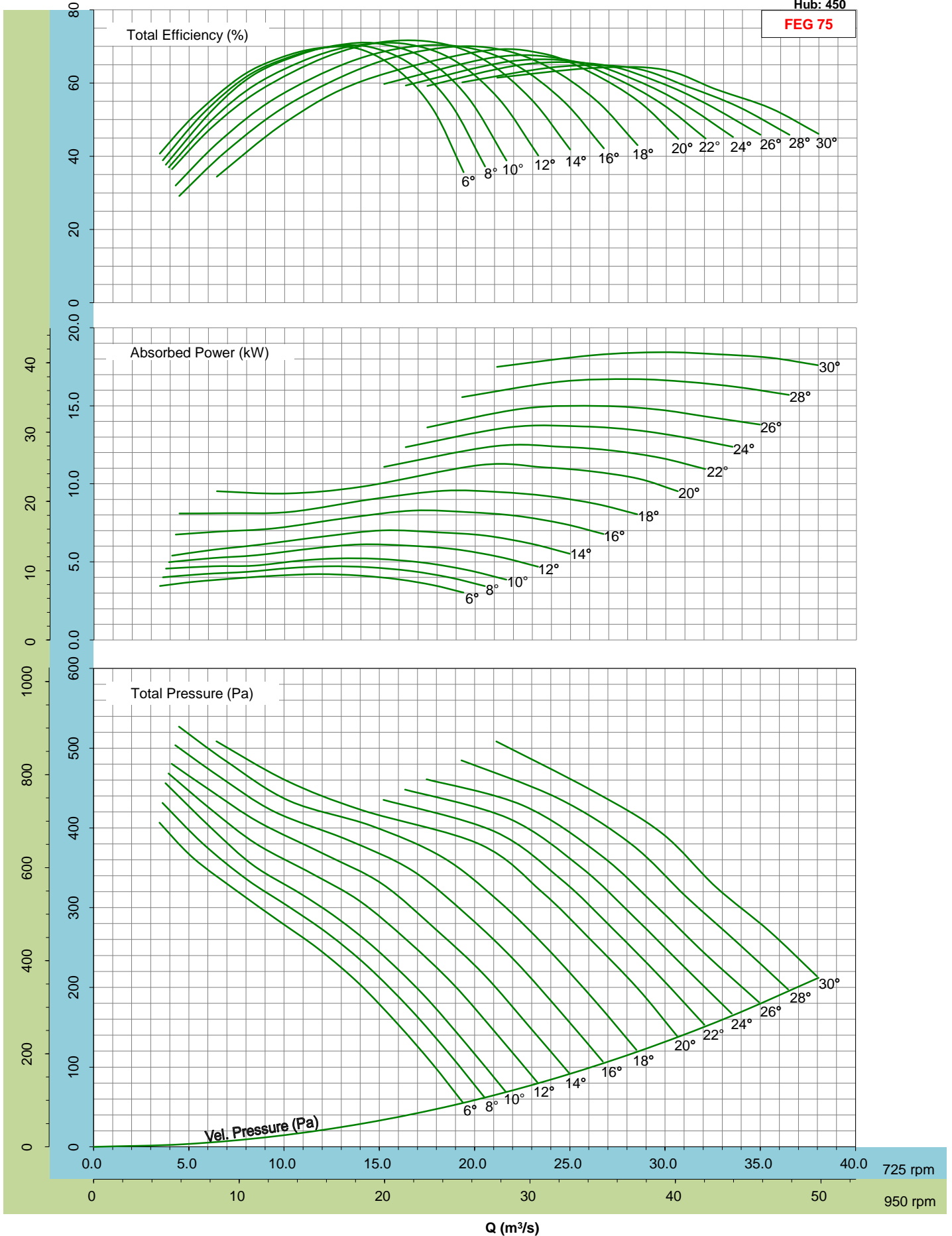

- Performance certified is for installation type D - ducted inlet, ducted outlet. Performance ratings do not include the effects of appurtenances (accessories).

$\rho=1.2\text{kg/m}^3$
Hub: 450

FEG 75

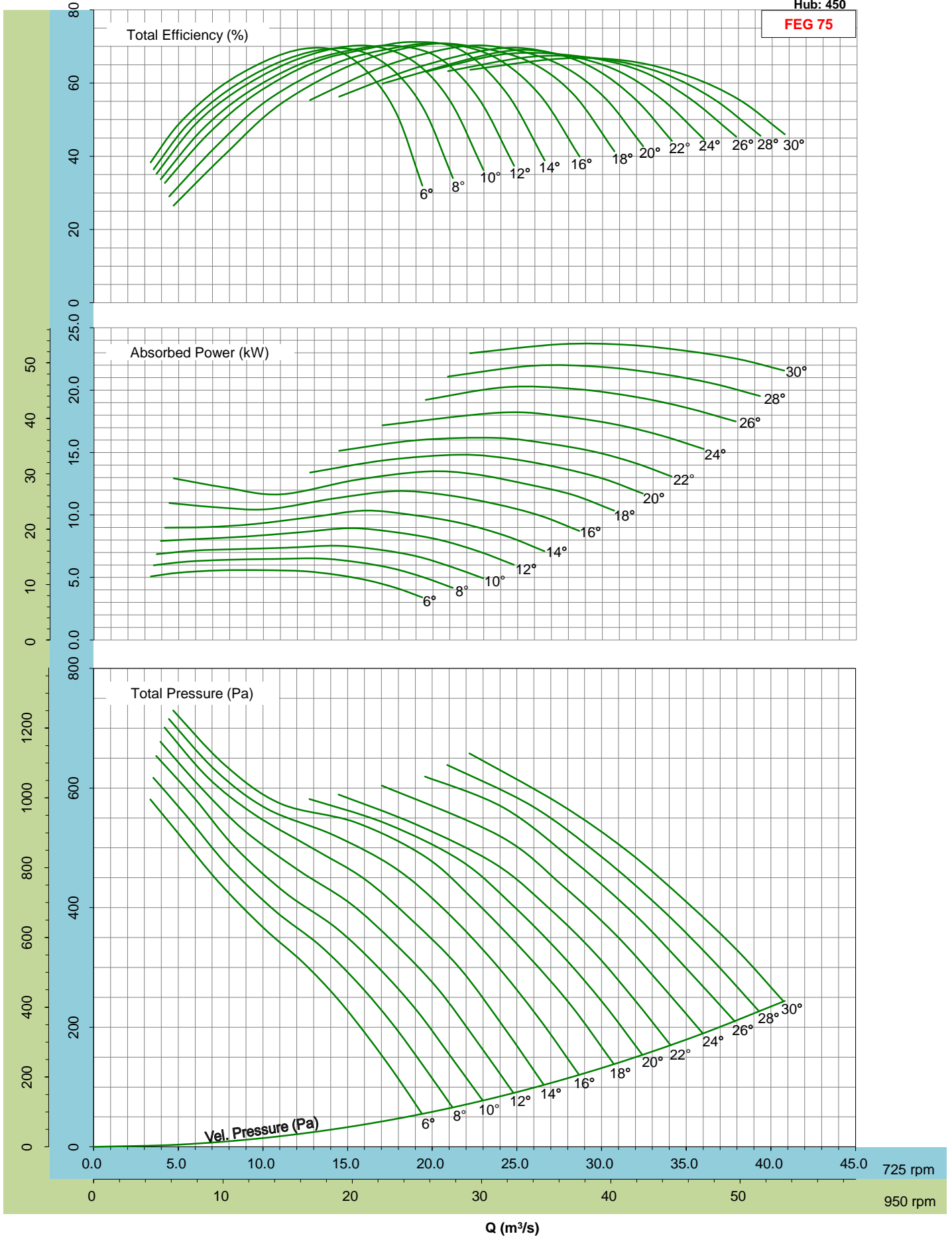

- Performance certified is for installation type D - ducted inlet, ducted outlet. Performance ratings do not include the effects of appurtenances (accessories).

$\rho=1.2\text{kg/m}^3$
Hub: 450

FEG 75

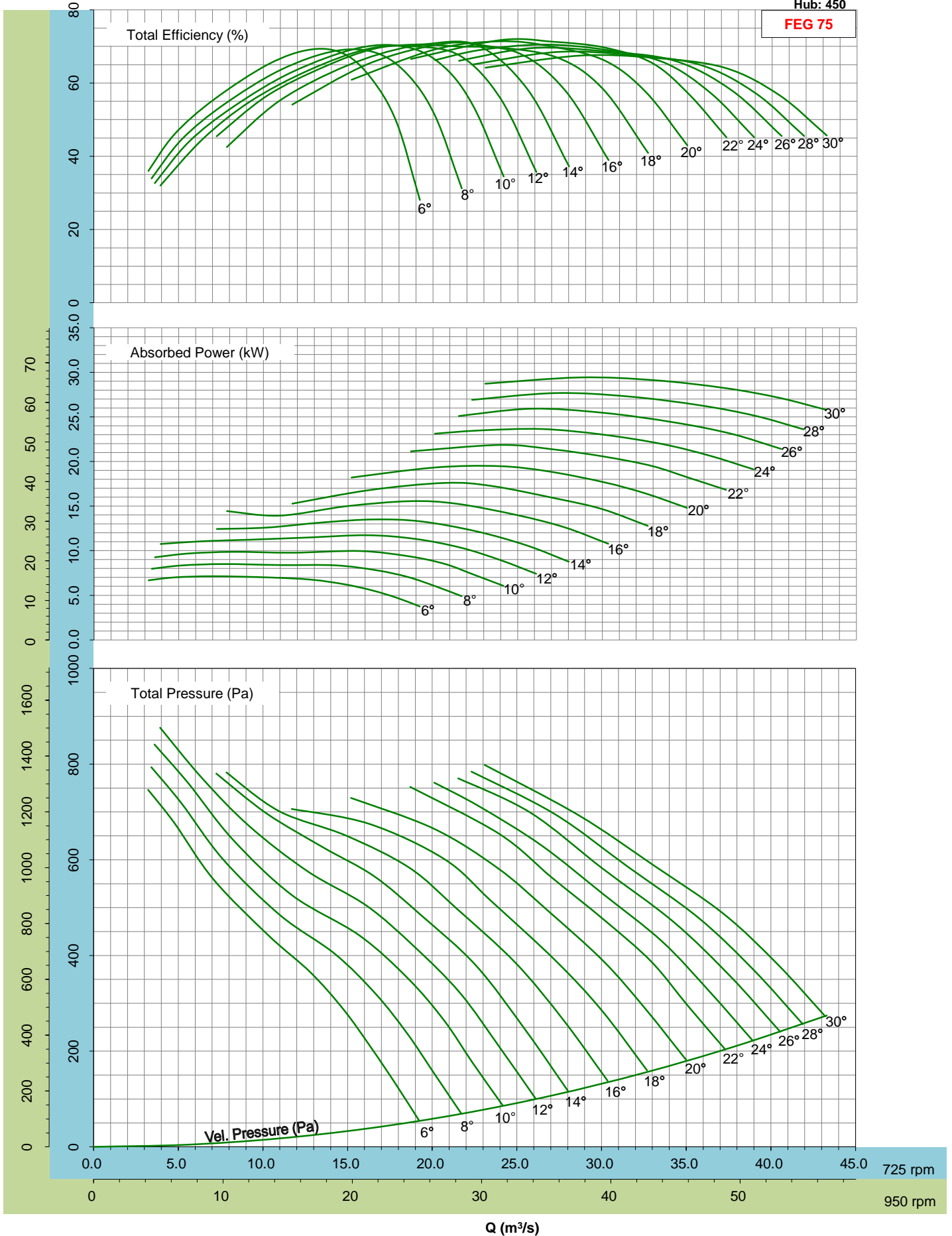

- Performance certified is for installation type D - ducted inlet, ducted outlet. Performance ratings do not include the effects of appurtenances (accessories).

$\rho=1.2\text{kg/m}^3$
Hub: 450

FEG 75

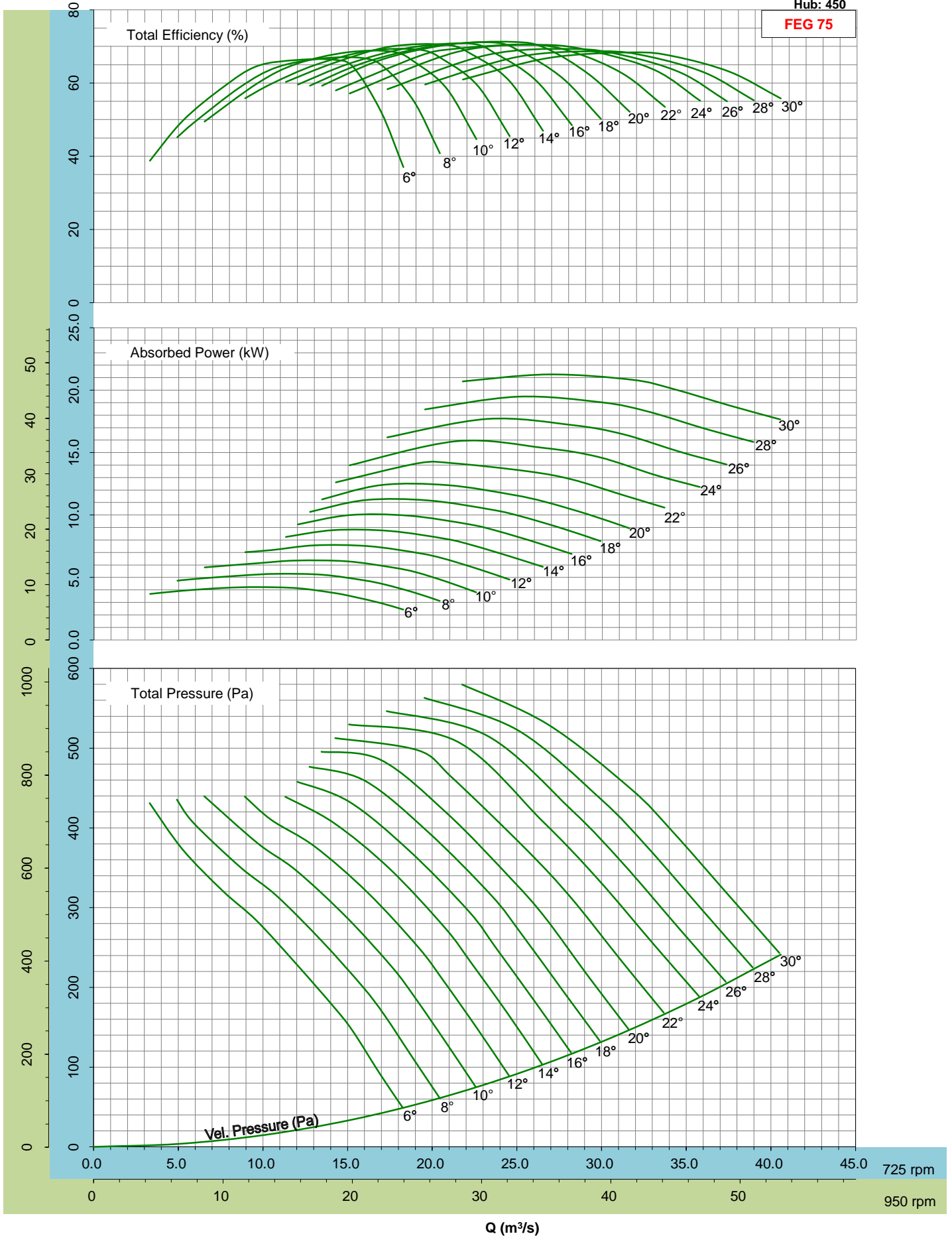

- Performance certified is for installation type D - ducted inlet, ducted outlet. Performance ratings do not include the effects of appurtenances (accessories).

$\rho=1.2\text{kg/m}^3$
Hub: 450

FEG 75

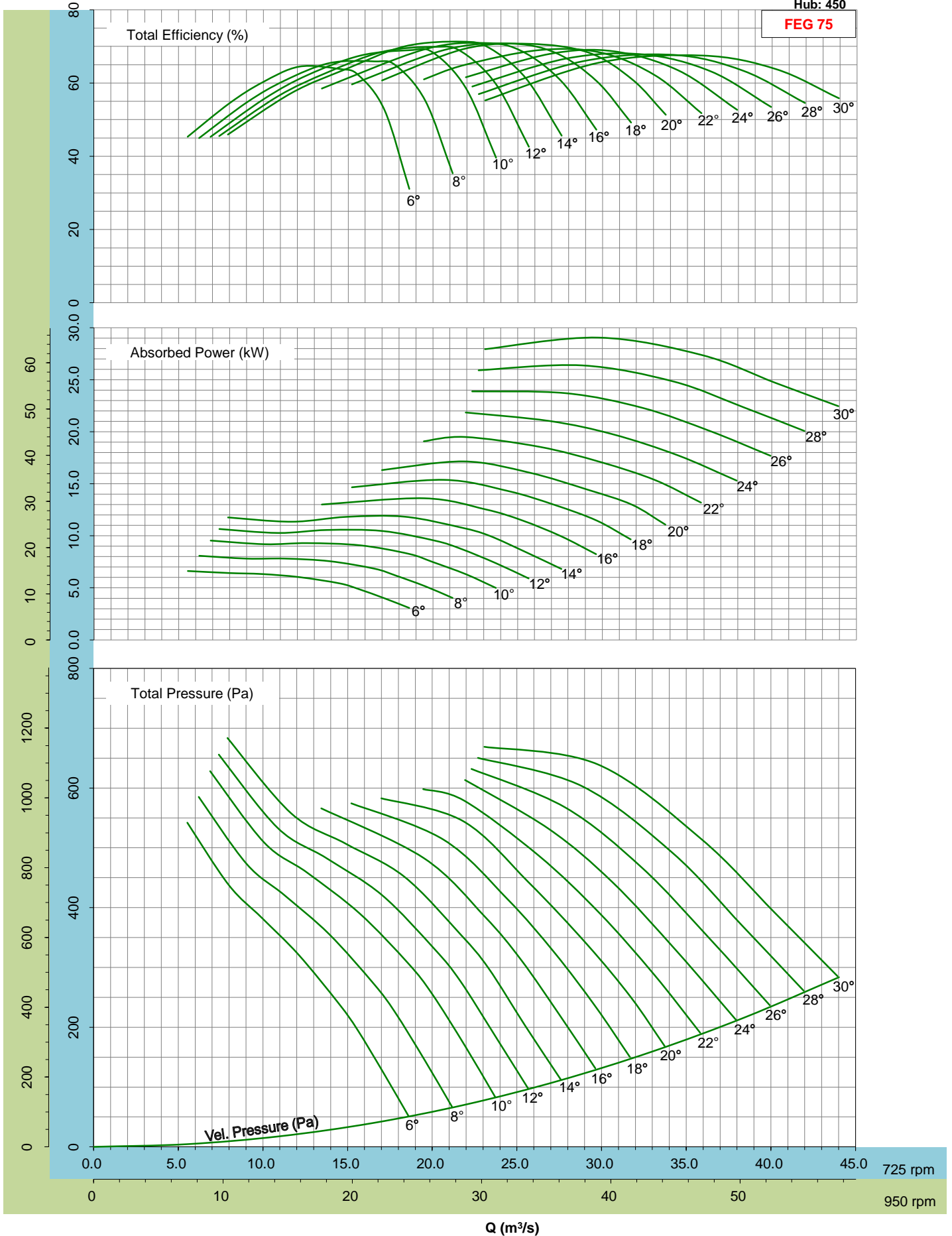

- Performance certified is for installation type D - ducted inlet, ducted outlet. Performance ratings do not include the effects of appurtenances (accessories).

$\rho=1.2\text{kg/m}^3$
Hub: 450

FEG 75

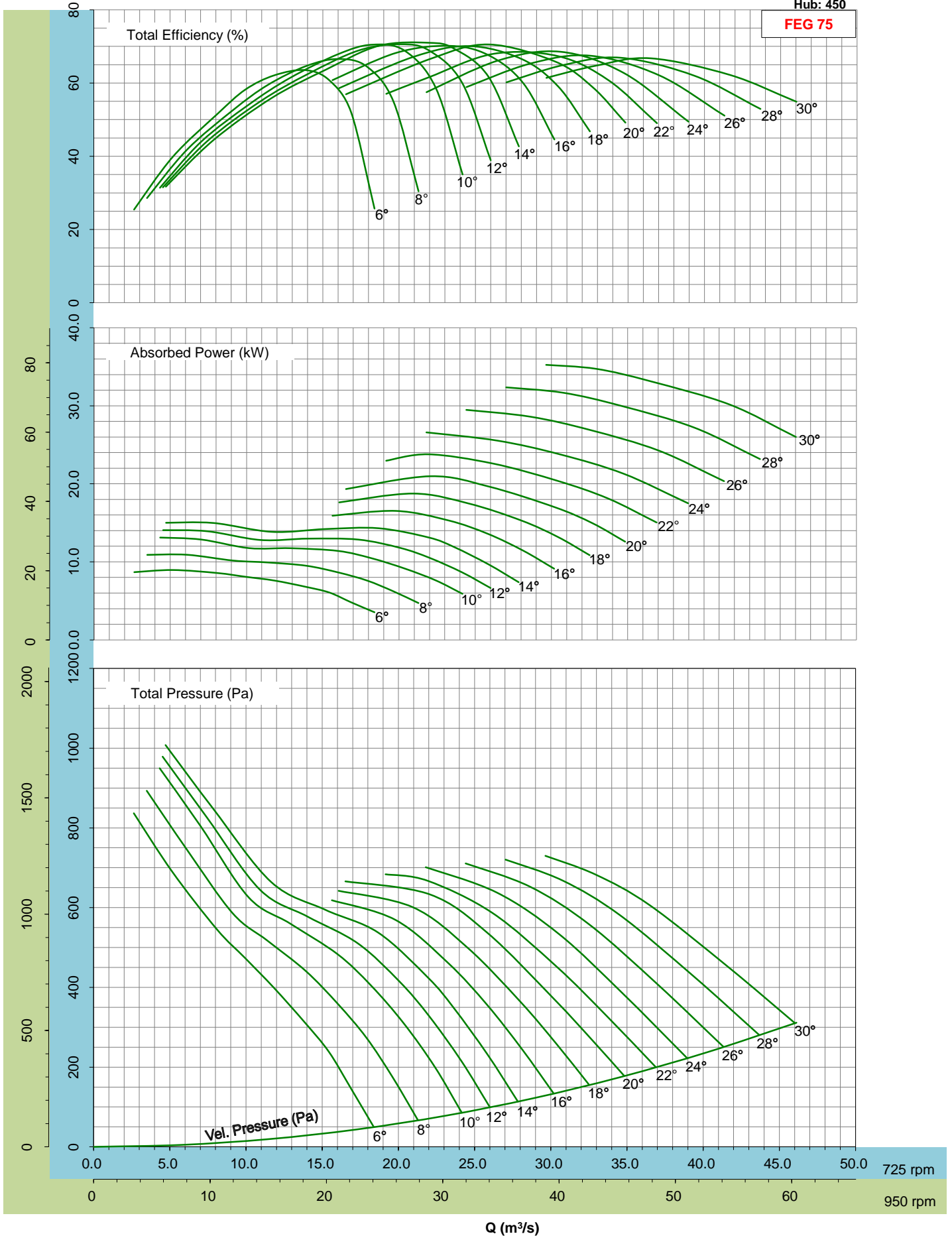

- Performance certified is for installation type D - ducted inlet, ducted outlet. Performance ratings do not include the effects of appurtenances (accessories).

$\rho=1.2\text{kg/m}^3$
Hub: 502

FEG 75

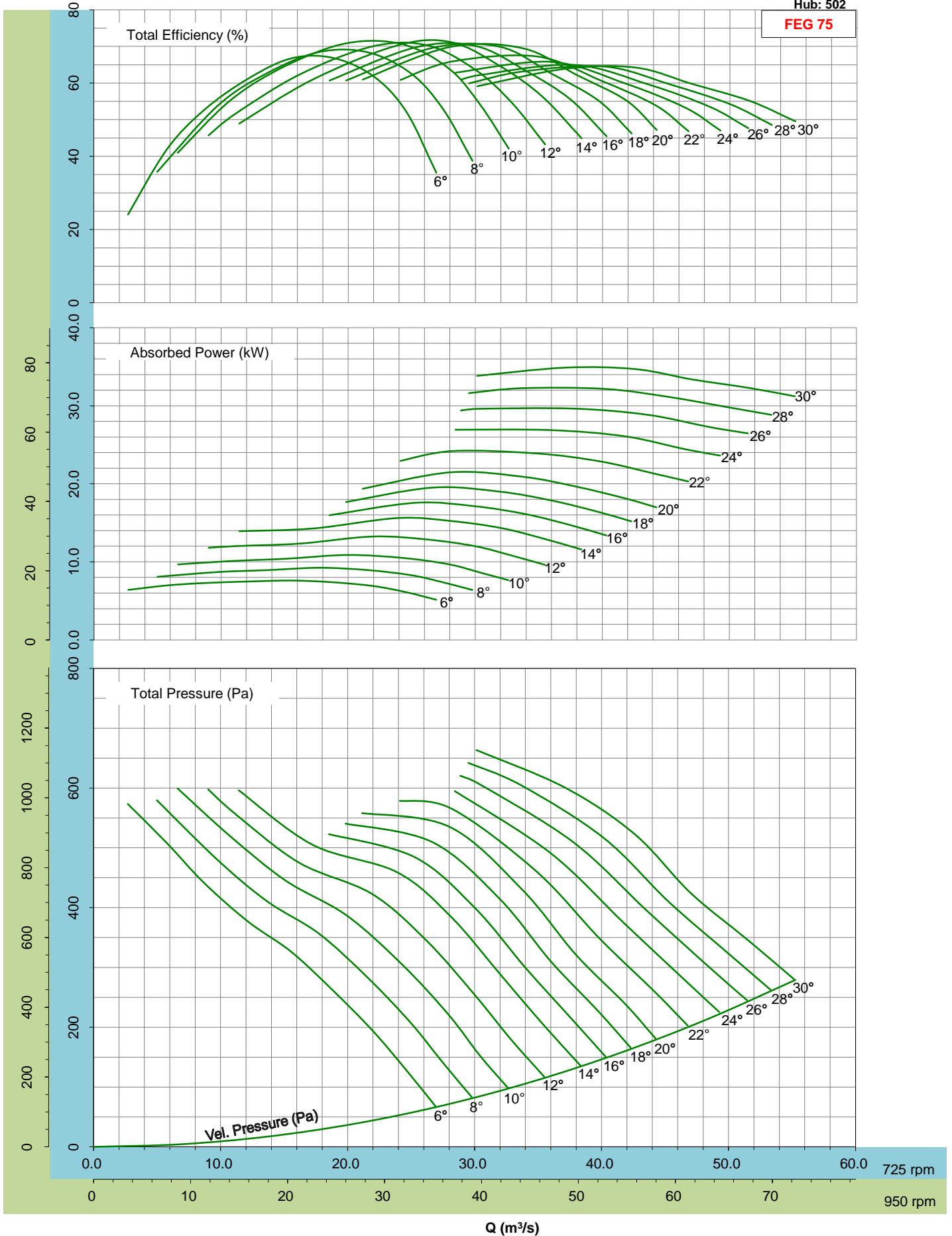

- Performance certified is for installation type D - ducted inlet, ducted outlet. Performance ratings do not include the effects of appurtenances (accessories).

$\rho=1.2\text{kg/m}^3$
Hub: 502

FEG 75

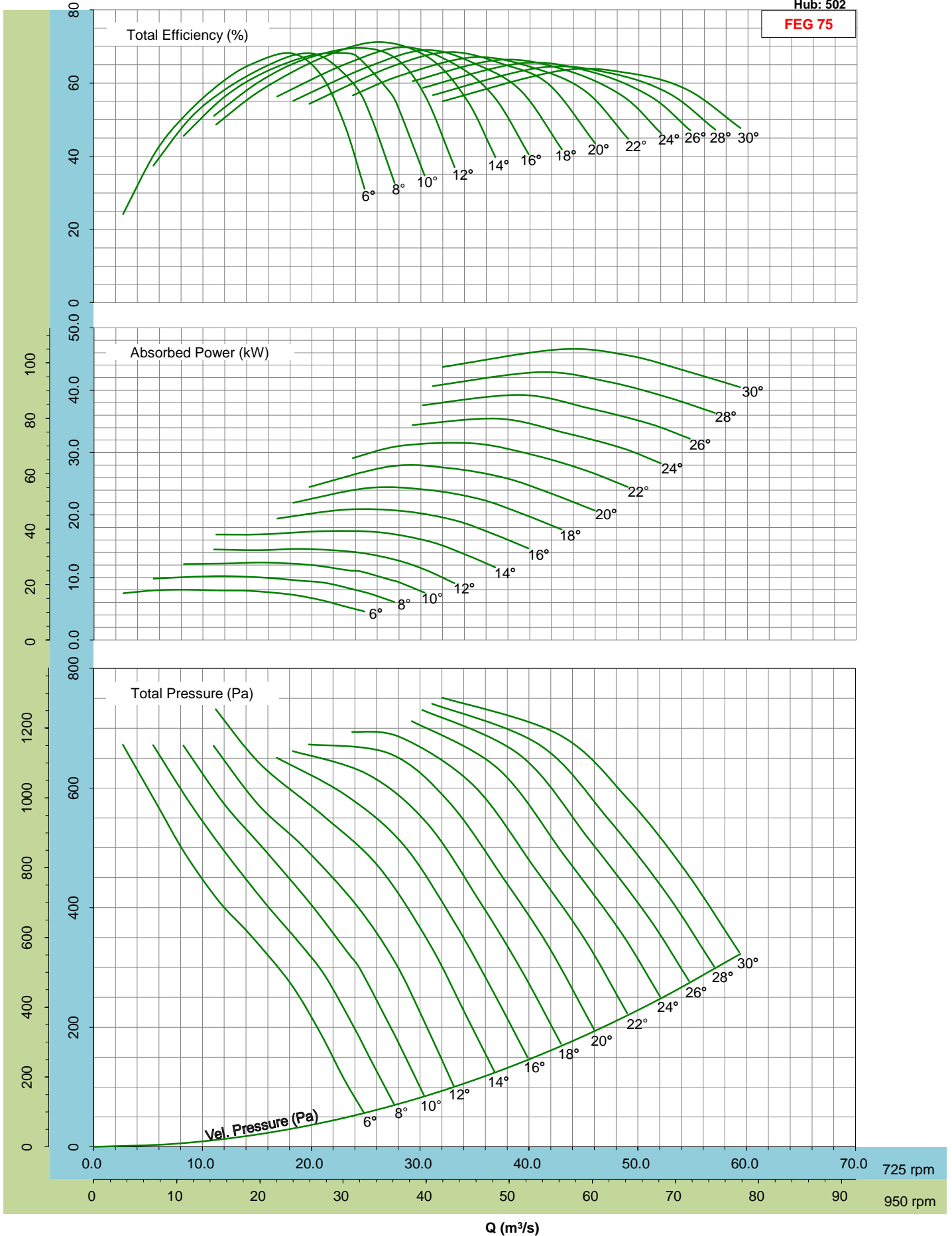

- Performance certified is for installation type D - ducted inlet, ducted outlet. Performance ratings do not include the effects of appurtenances (accessories).

$\rho=1.2\text{kg/m}^3$
Hub: 502

FEG 75

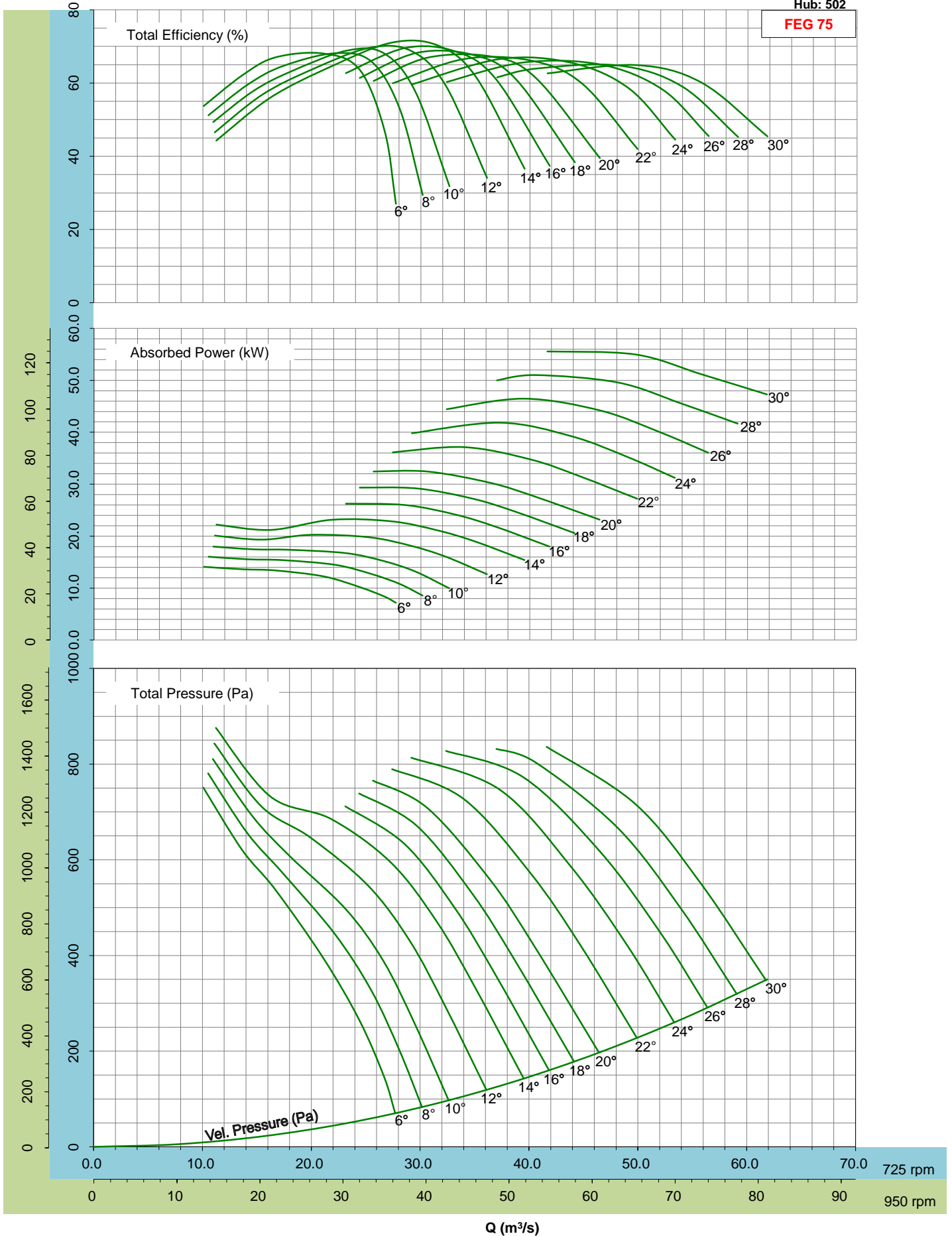

- Performance certified is for installation type D - ducted inlet, ducted outlet. Performance ratings do not include the effects of appurtenances (accessories).

$\rho=1.2\text{kg/m}^3$
Hub: 560

FEG 75

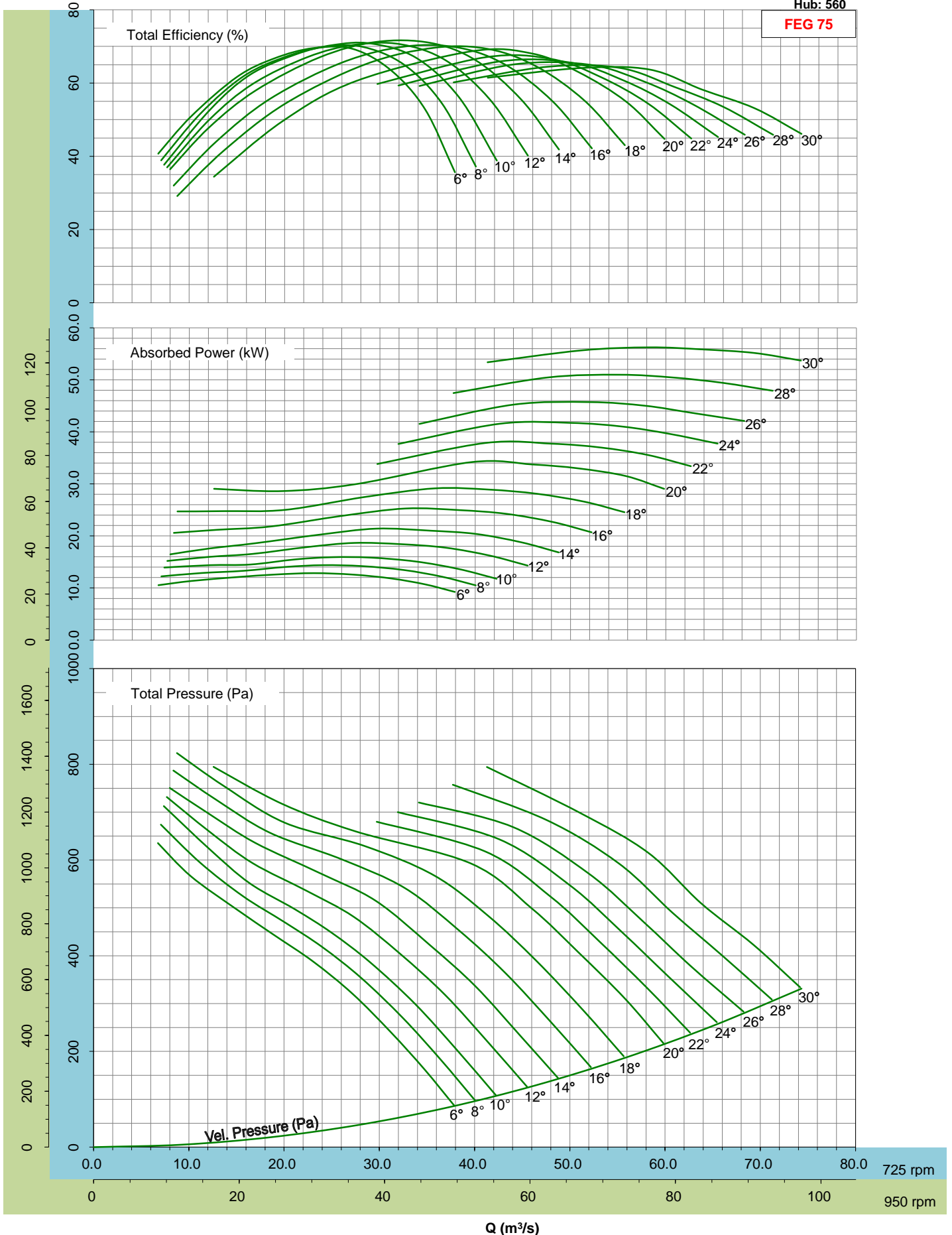

- Performance certified is for installation type D - ducted inlet, ducted outlet. Performance ratings do not include the effects of appurtenances (accessories).
- Please consult the nearest Kruger office for fan selection at 950rpm.

$\rho=1.2\text{kg/m}^3$
Hub: 560

FEG 75

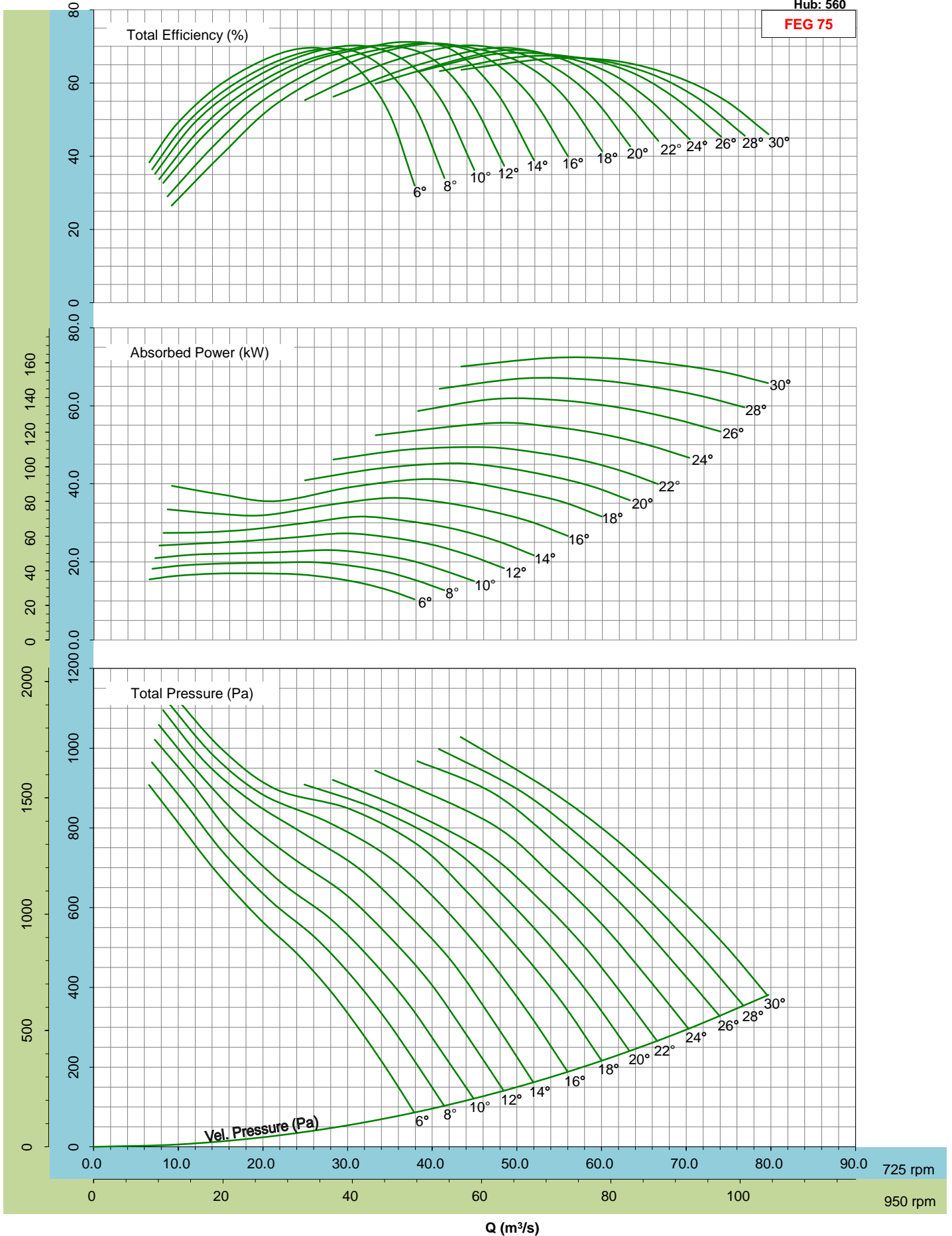

- Performance certified is for installation type D - ducted inlet, ducted outlet. Performance ratings do not include the effects of appurtenances (accessories).

- Please consult the nearest Kruger office for fan selection at 950rpm.

$\rho=1.2\text{kg/m}^3$
Hub: 560

FEG 75

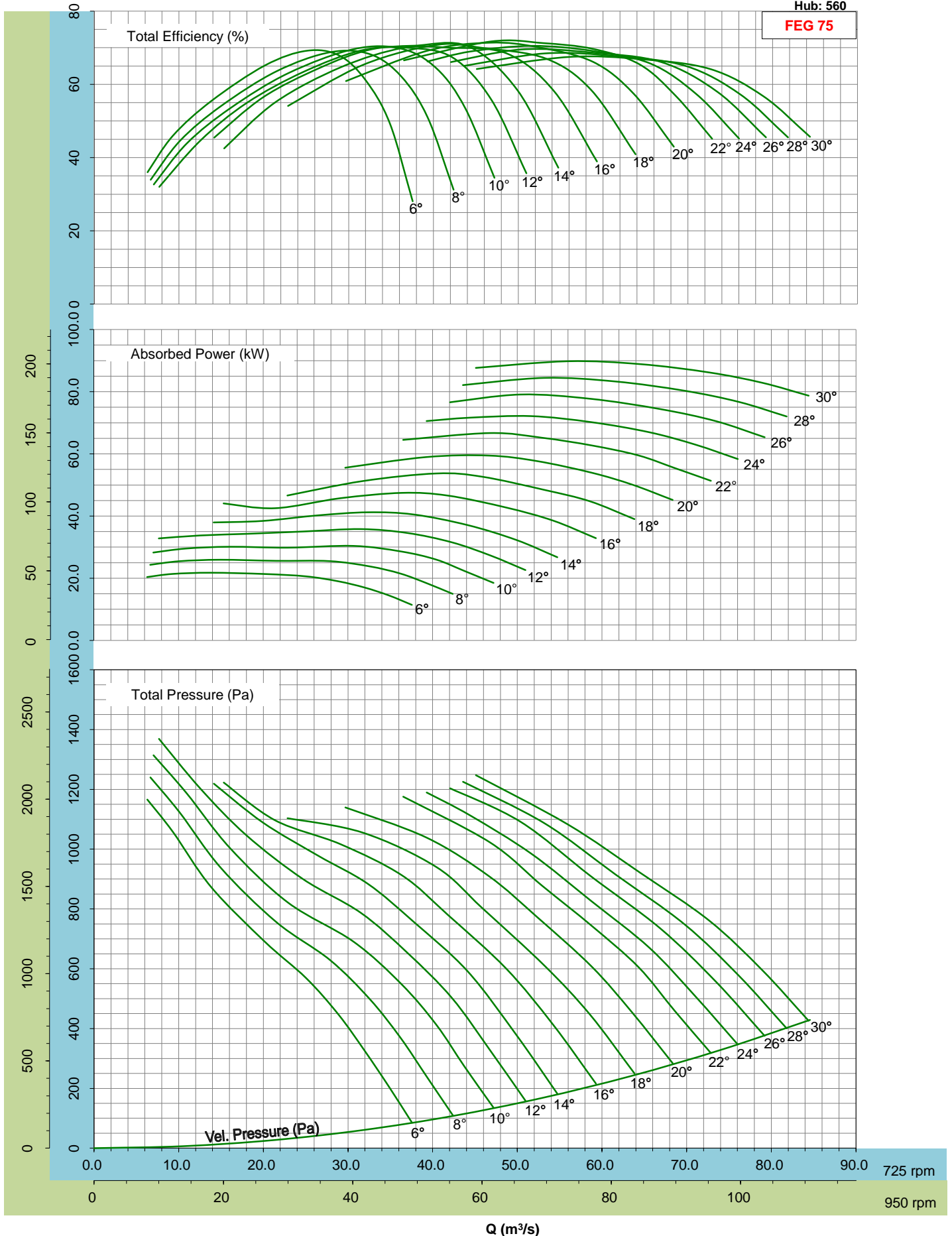

- Performance certified is for installation type D - ducted inlet, ducted outlet. Performance ratings do not include the effects of appurtenances (accessories).
 - Please consult the nearest Kruger office for fan selection at 950rpm.

$\rho=1.2\text{kg/m}^3$
Hub: 186

FEG 71

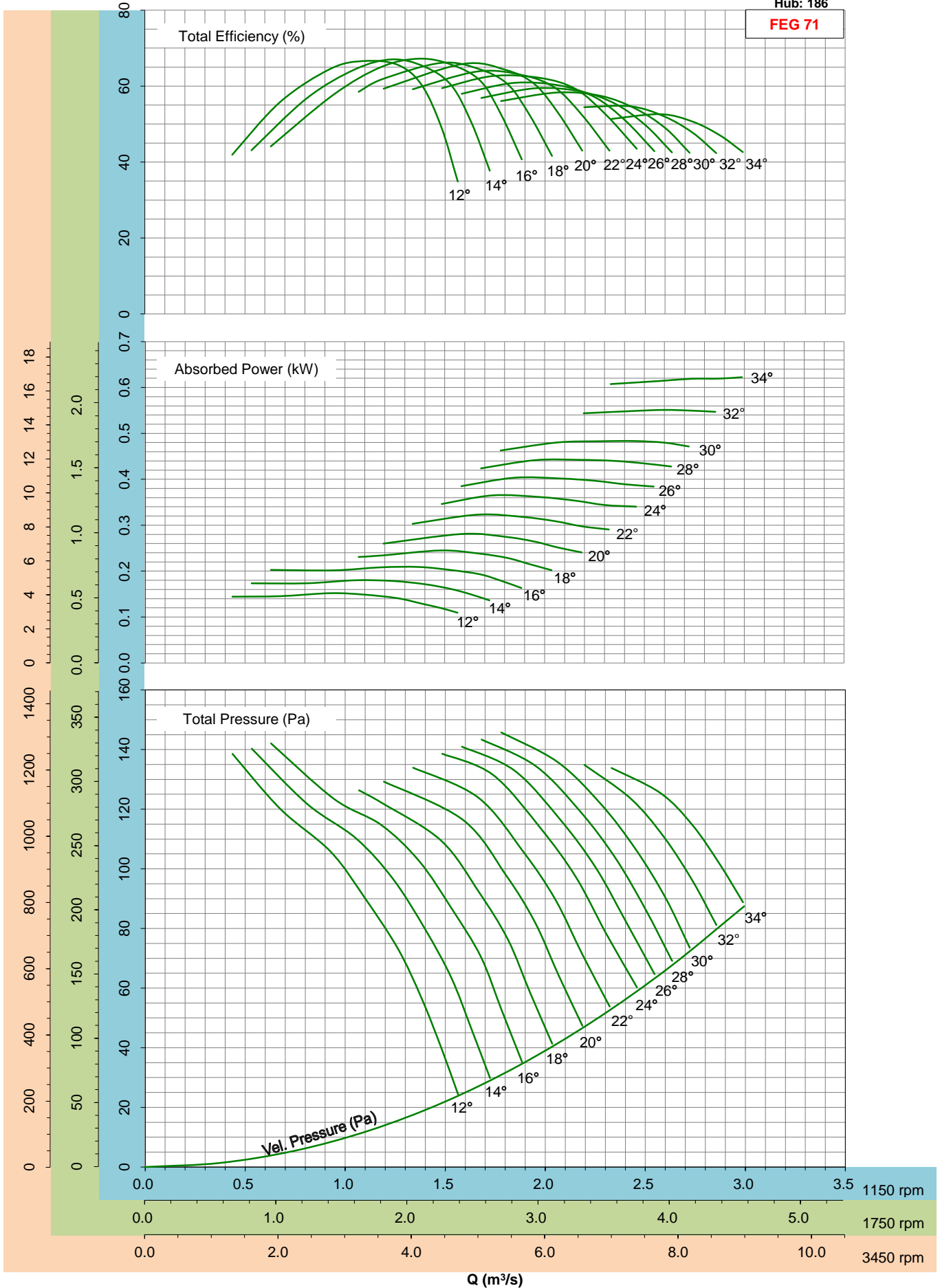

- Performance certified is for installation type D - ducted inlet, ducted outlet. Performance ratings do not include the effects of appurtenances (accessories).

- Please consult the nearest Kruger office for fan selection at 3450rpm.

$\rho=1.2\text{kg/m}^3$
Hub: 186

FEG 71

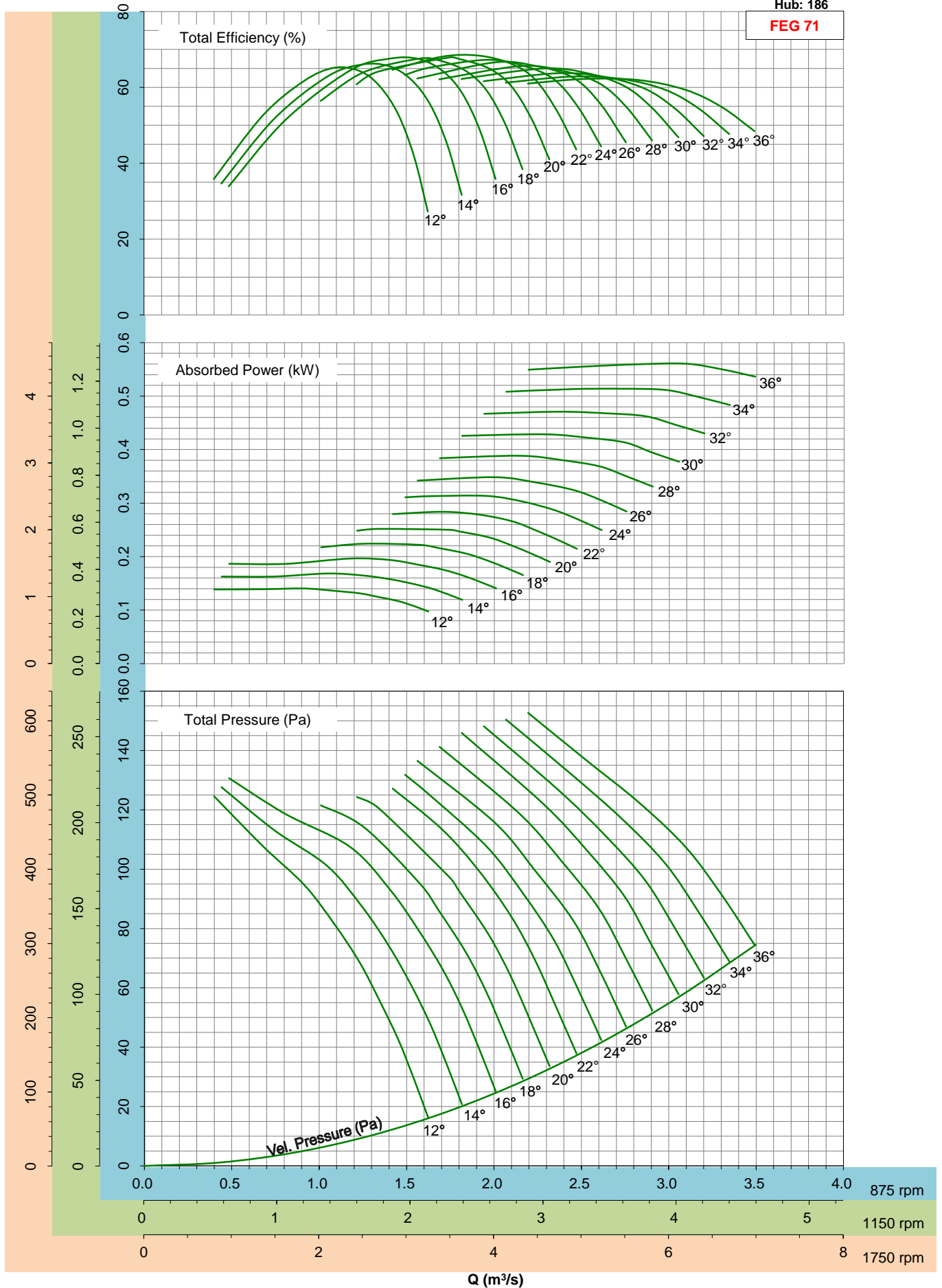

- Performance certified is for installation type D - ducted inlet, ducted outlet. Performance ratings do not include the effects of appurtenances (accessories).

$\rho=1.2\text{kg/m}^3$
Hub: 145

FEG 71

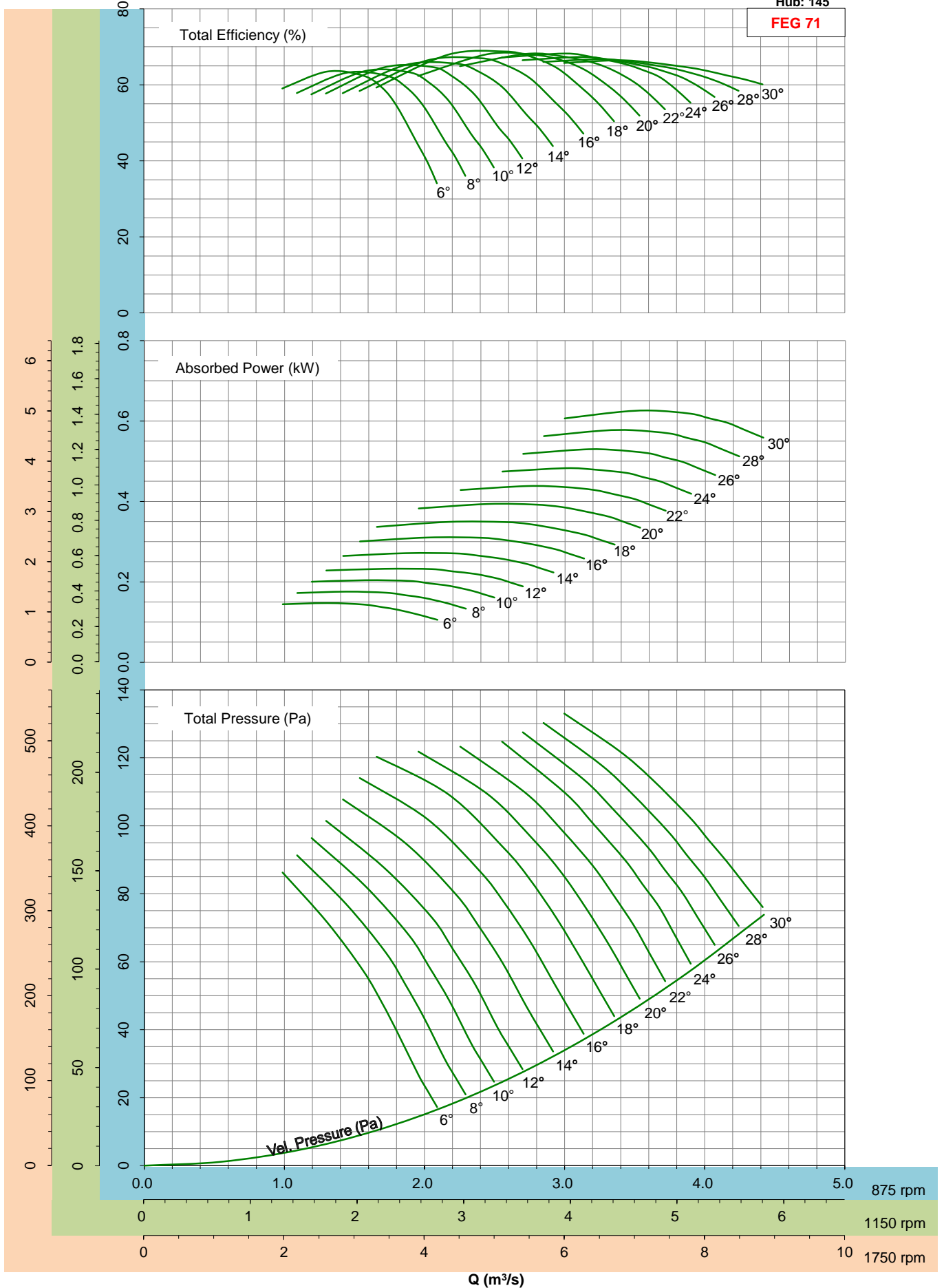

- Performance certified is for installation type D - ducted inlet, ducted outlet. Performance ratings do not include the effects of appurtenances (accessories).

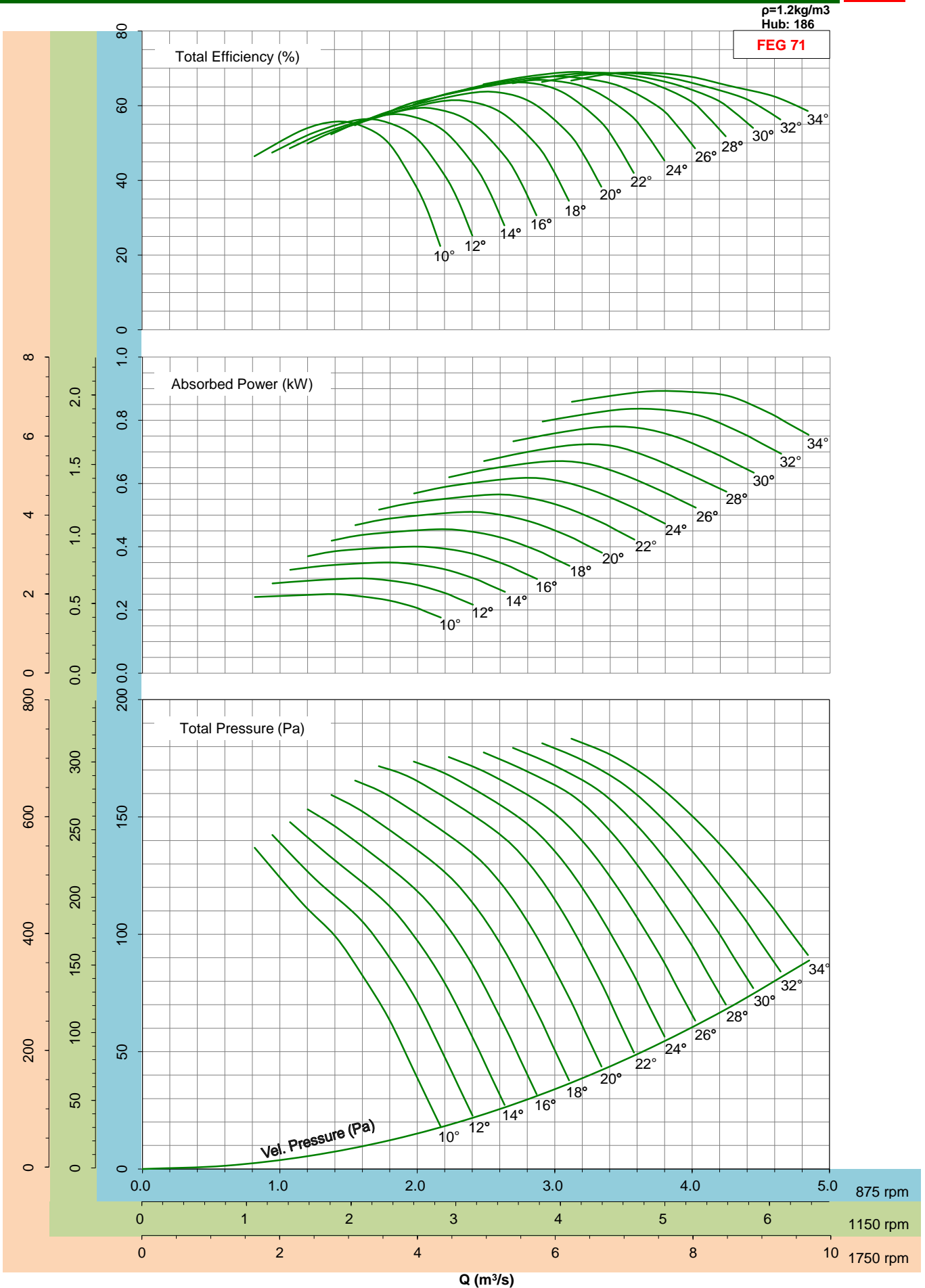

- Performance certified is for installation type D - ducted inlet, ducted outlet. Performance ratings do not include the effects of appurtenances (accessories).

$\rho=1.2\text{kg/m}^3$
Hub: 186

FEG 75

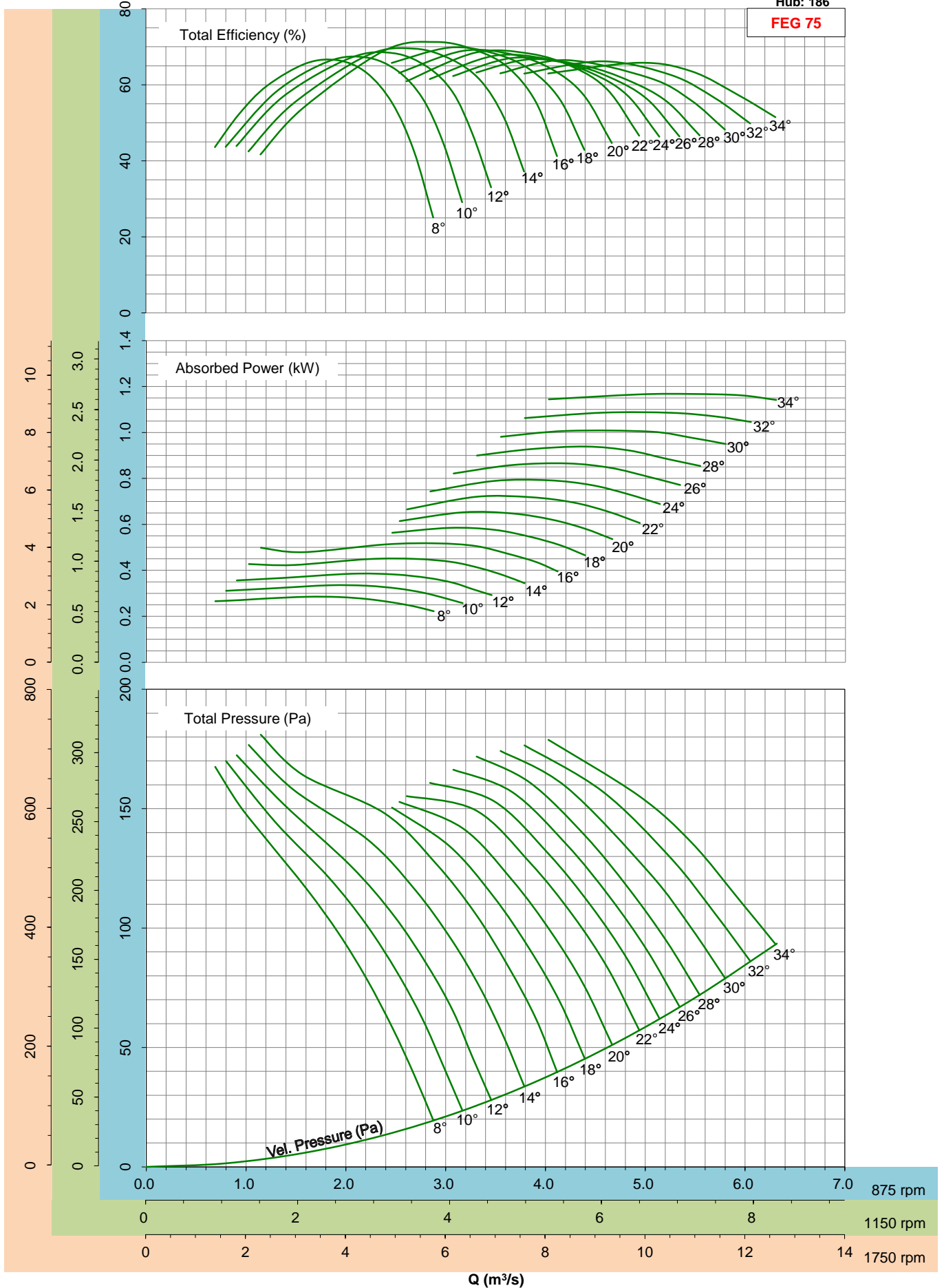

- Performance certified is for installation type D - ducted inlet, ducted outlet. Performance ratings do not include the effects of appurtenances (accessories).

$\rho=1.2\text{kg/m}^3$
Hub: 200

FEG 75

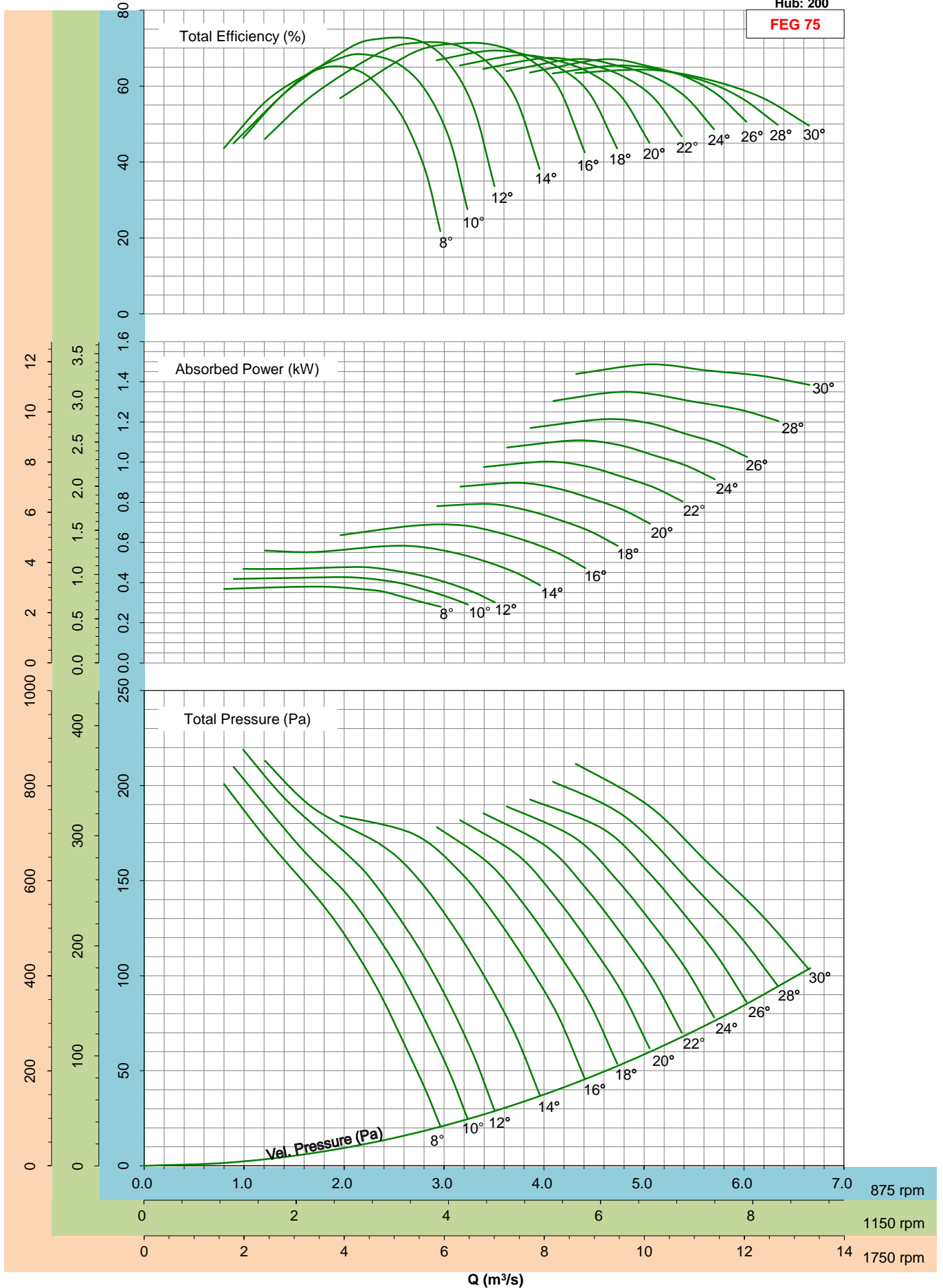

- Performance certified is for installation type D - ducted inlet, ducted outlet. Performance ratings do not include the effects of appurtenances (accessories).

$\rho=1.2\text{kg/m}^3$
Hub: 280

FEG 75

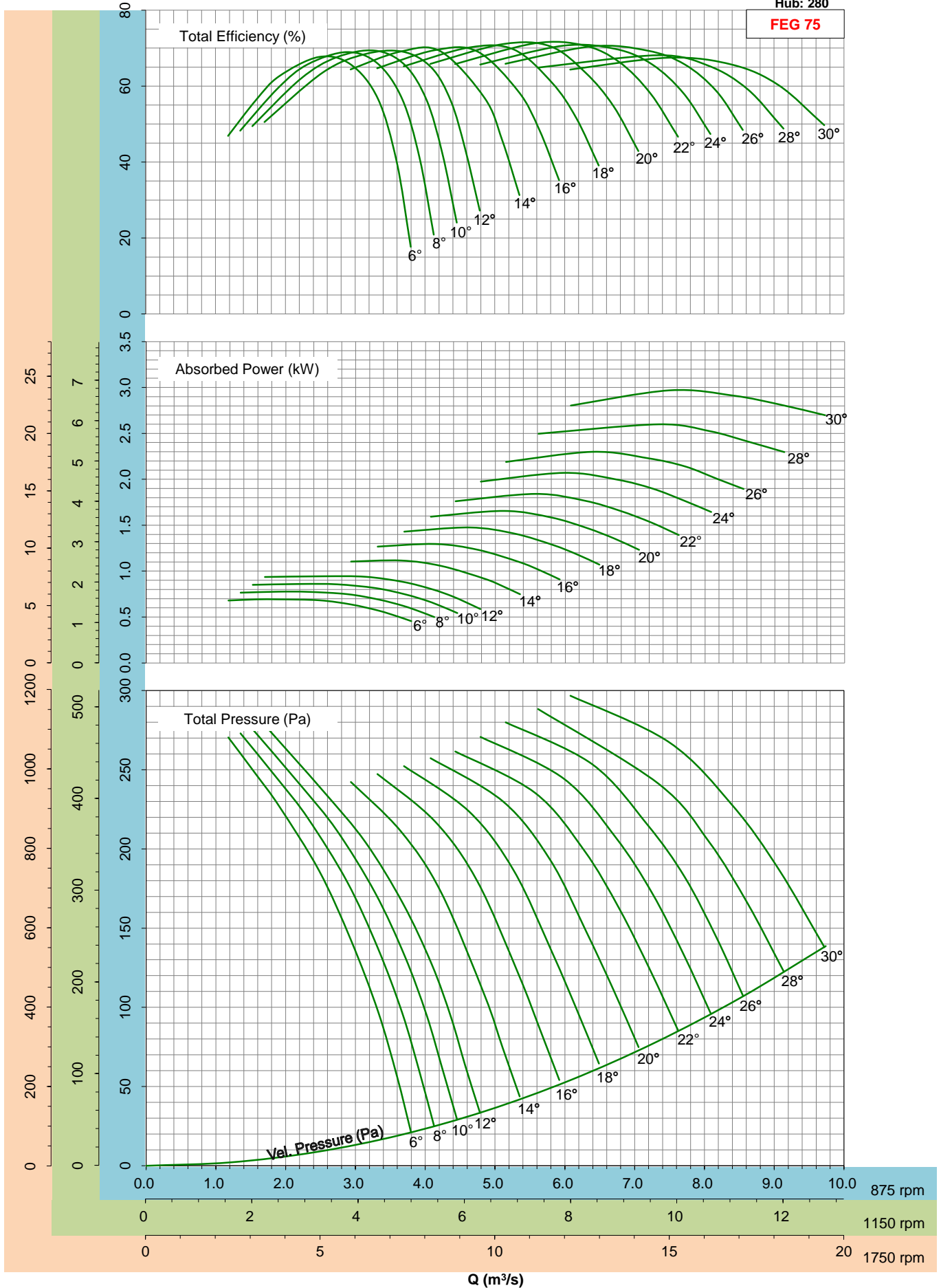

- Performance certified is for installation type D - ducted inlet, ducted outlet. Performance ratings do not include the effects of appurtenances (accessories).

$\rho=1.2\text{kg/m}^3$
Hub: 186

FEG 75

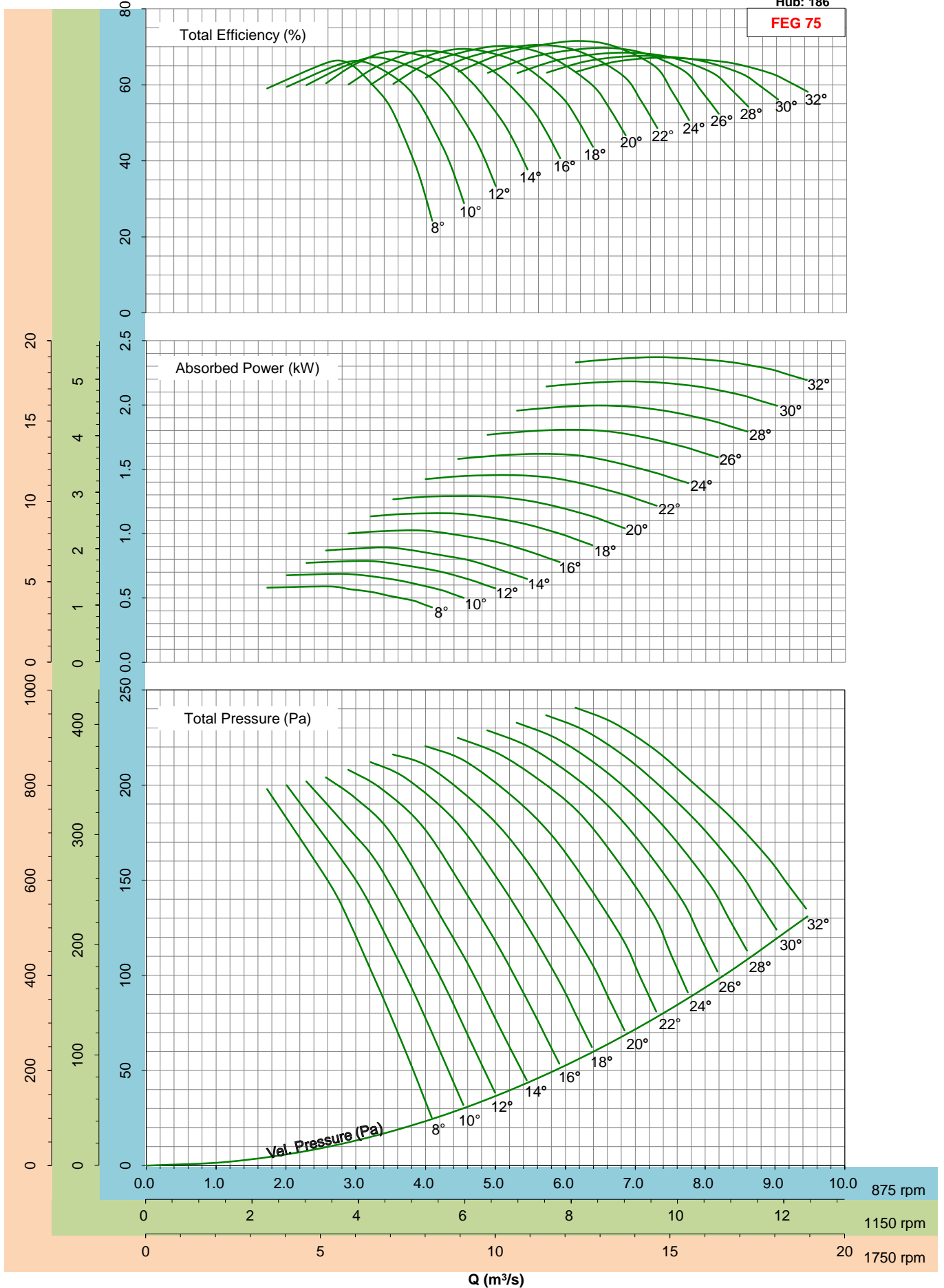

- Performance certified is for installation type D - ducted inlet, ducted outlet. Performance ratings do not include the effects of appurtenances (accessories).

$\rho=1.2\text{kg/m}^3$
Hub: 200

FEG 75

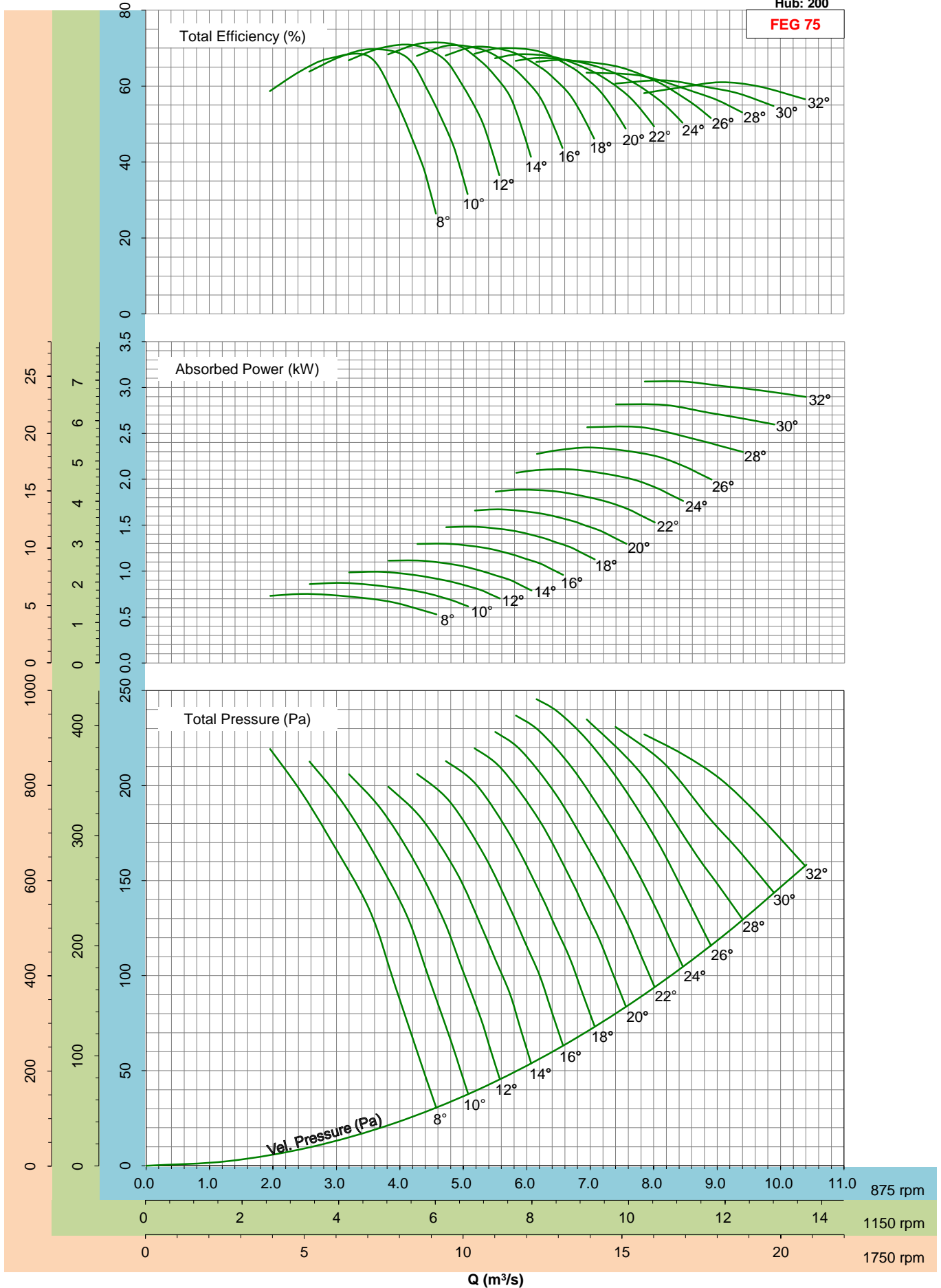

- Performance certified is for installation type D - ducted inlet, ducted outlet. Performance ratings do not include the effects of appurtenances (accessories).

$\rho=1.2\text{kg/m}^3$
Hub: 280

FEG 75

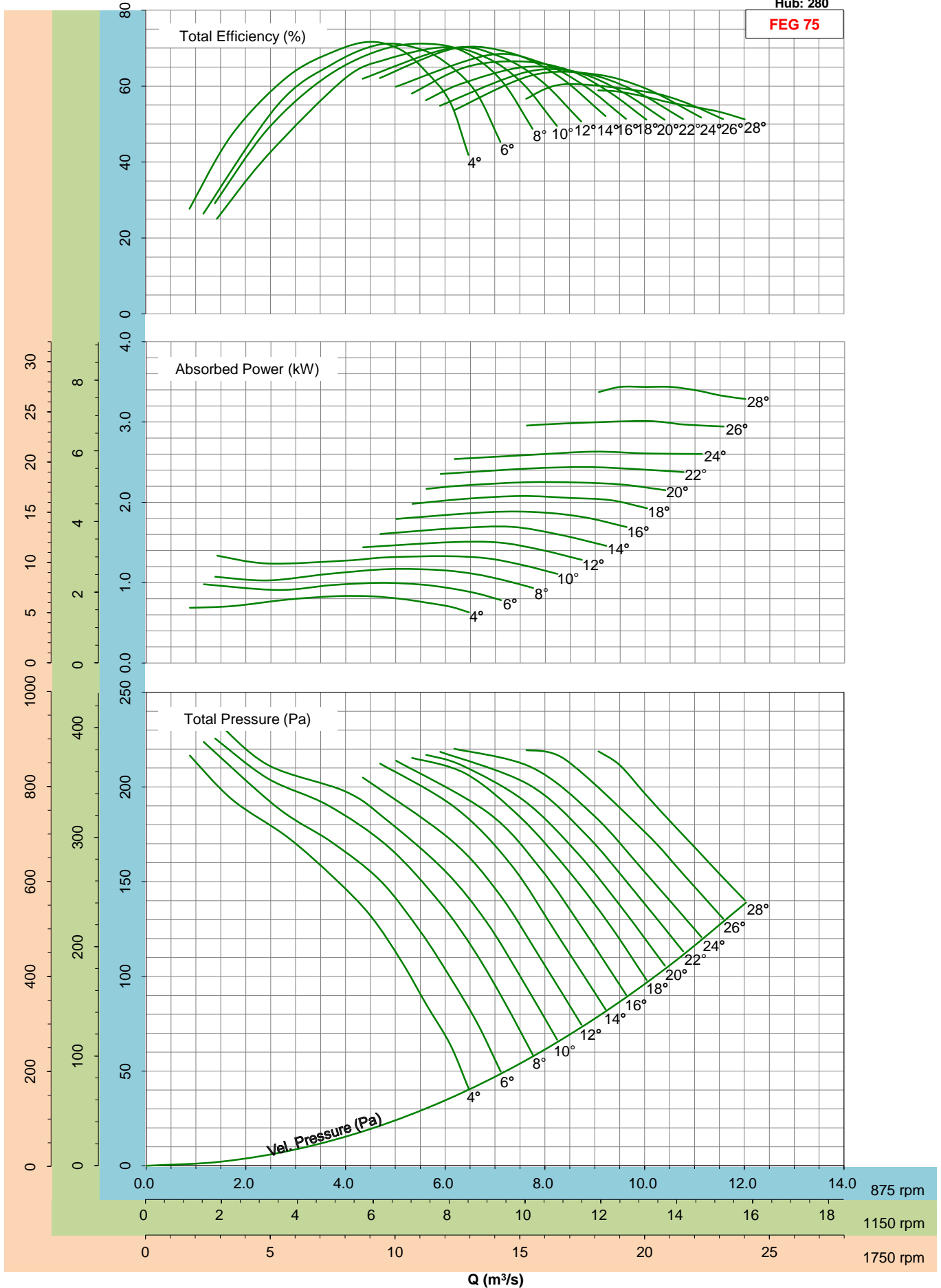

- Performance certified is for installation type D - ducted inlet, ducted outlet. Performance ratings do not include the effects of appurtenances (accessories).

- Please consult the nearest Kruger office for fan selection at 1750rpm.

$\rho=1.2\text{kg/m}^3$
Hub: 200

FEG 75

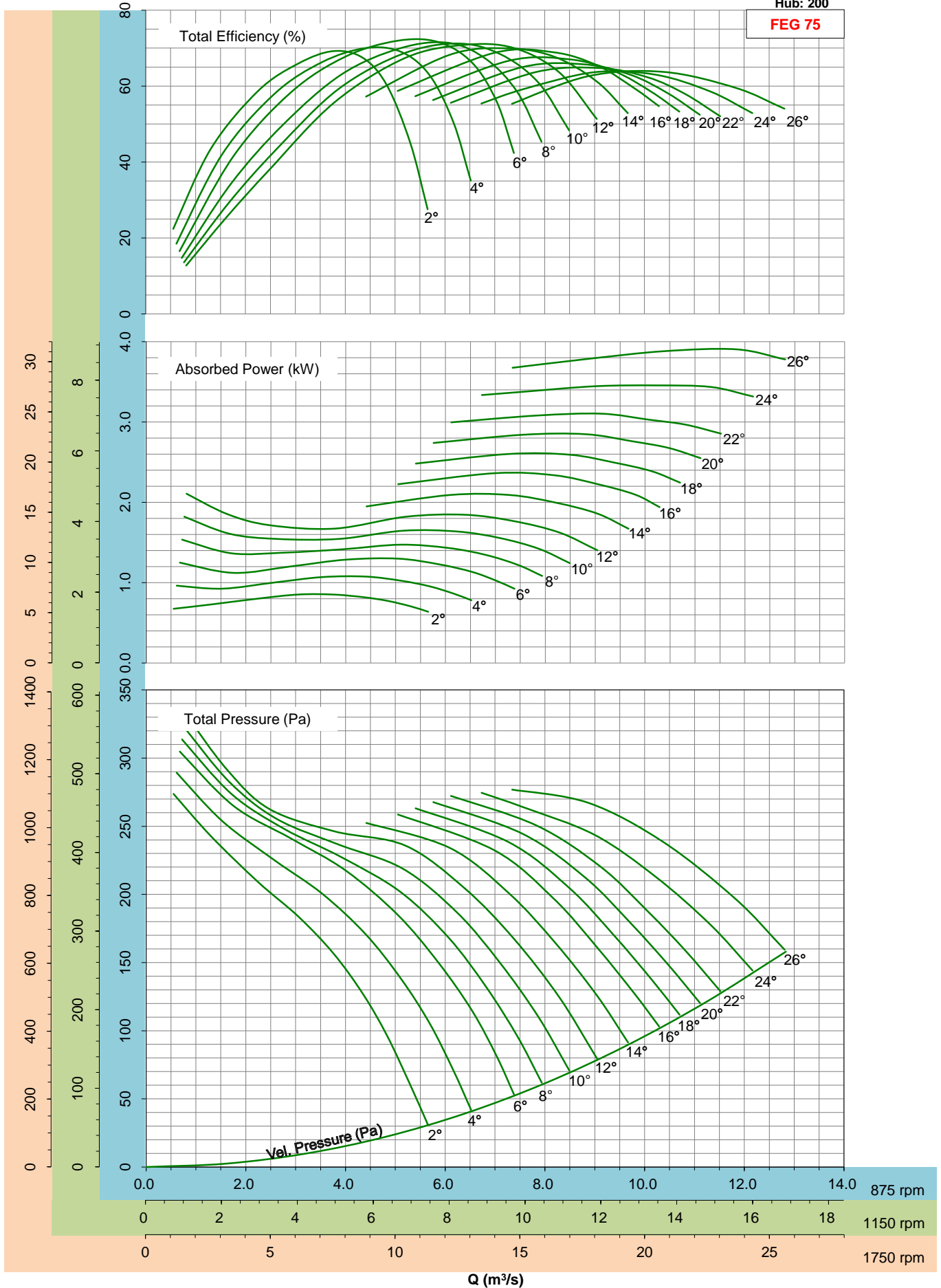

- Performance certified is for installation type D - ducted inlet, ducted outlet. Performance ratings do not include the effects of appurtenances (accessories).

- Please consult the nearest Kruger office for fan selection at 1750rpm.

$\rho=1.2\text{kg/m}^3$
Hub: 280

FEG 75

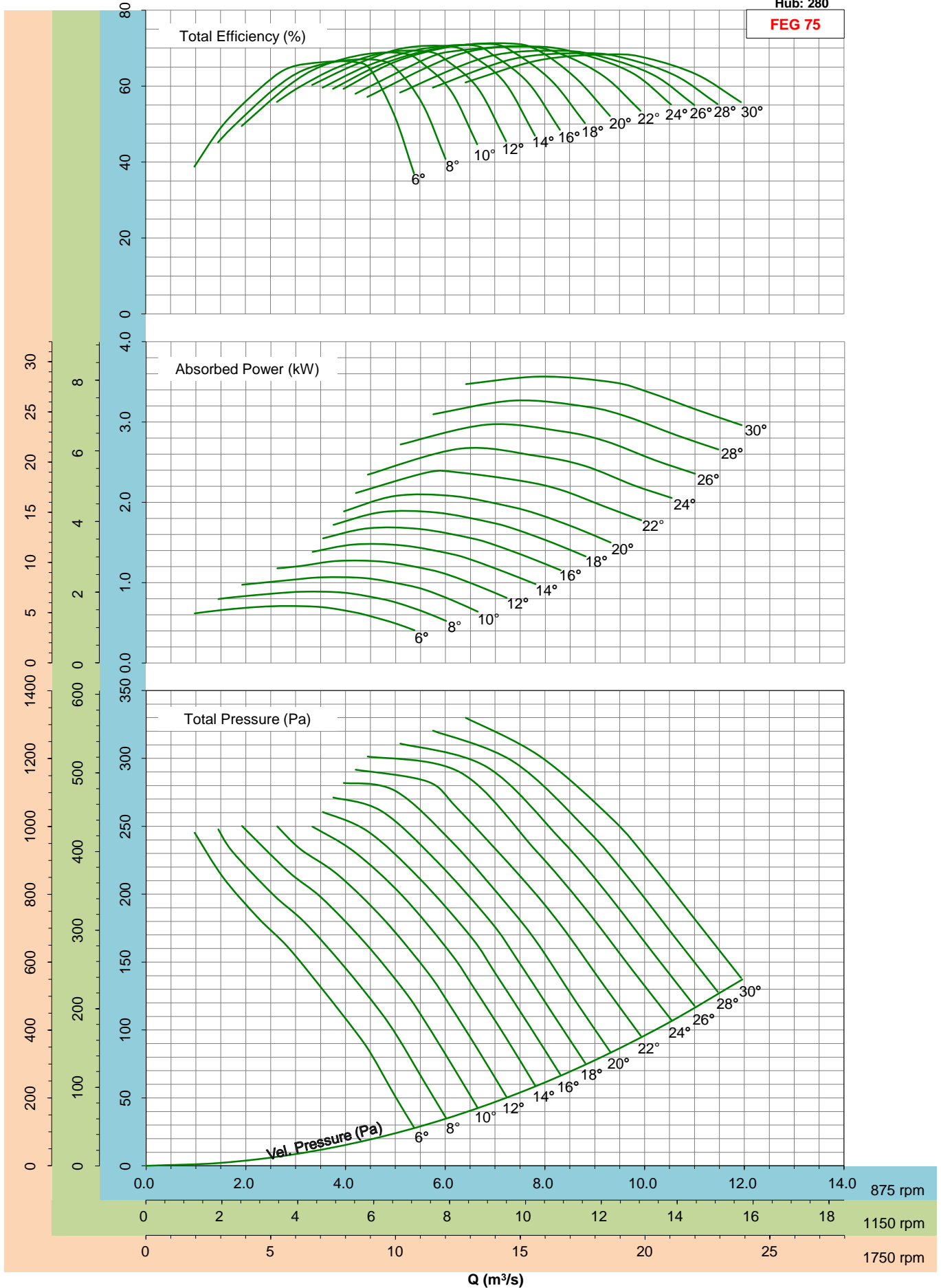

- Performance certified is for installation type D - ducted inlet, ducted outlet. Performance ratings do not include the effects of appurtenances (accessories).

- Please consult the nearest Kruger office for fan selection at 1750rpm.

$\rho=1.2\text{kg/m}^3$
Hub: 280

FEG 75

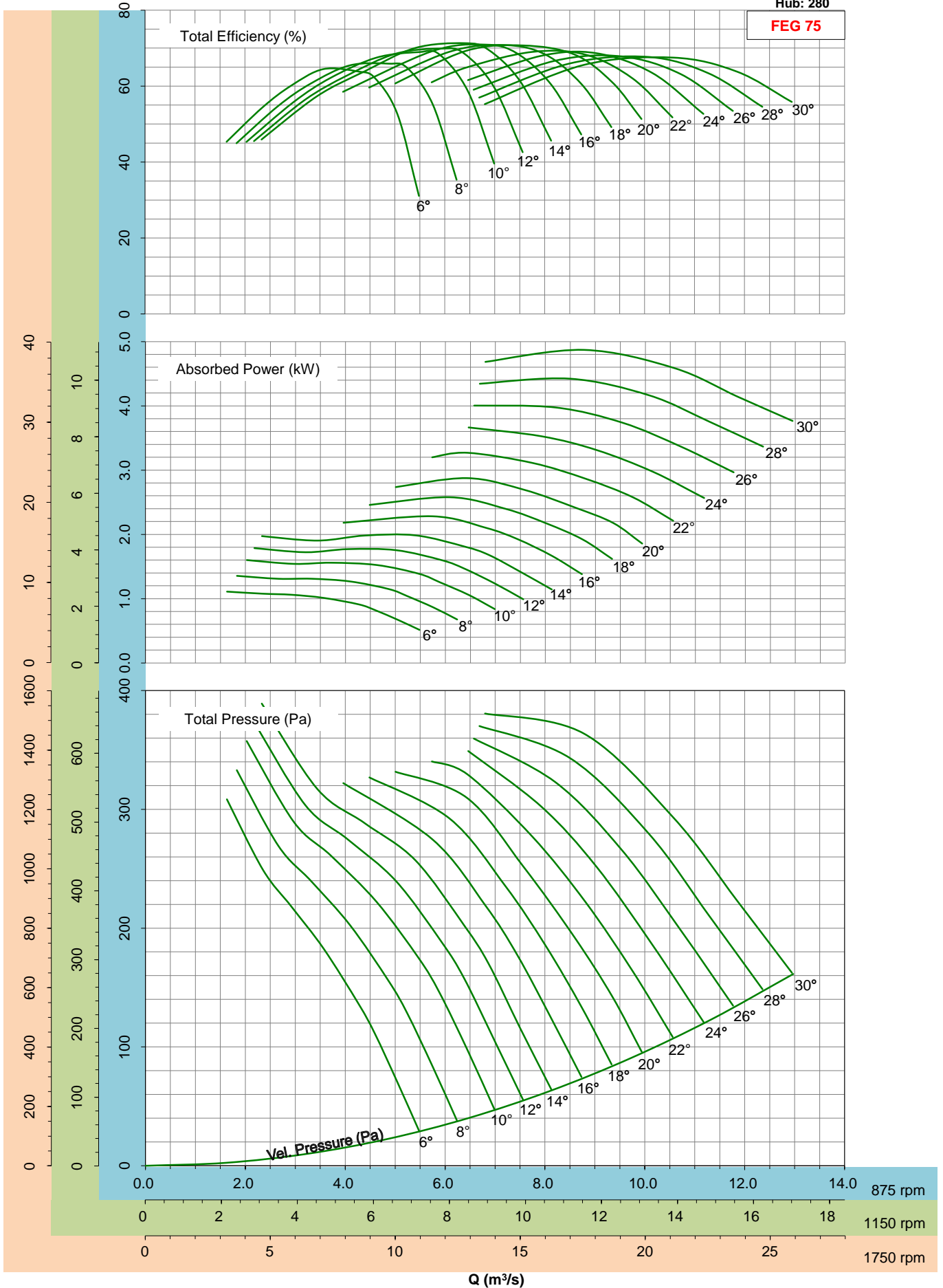

- Performance certified is for installation type D - ducted inlet, ducted outlet. Performance ratings do not include the effects of appurtenances (accessories).

- Please consult the nearest Kruger office for fan selection at 1750rpm.

$\rho=1.2\text{kg/m}^3$
Hub: 280

FEG 75

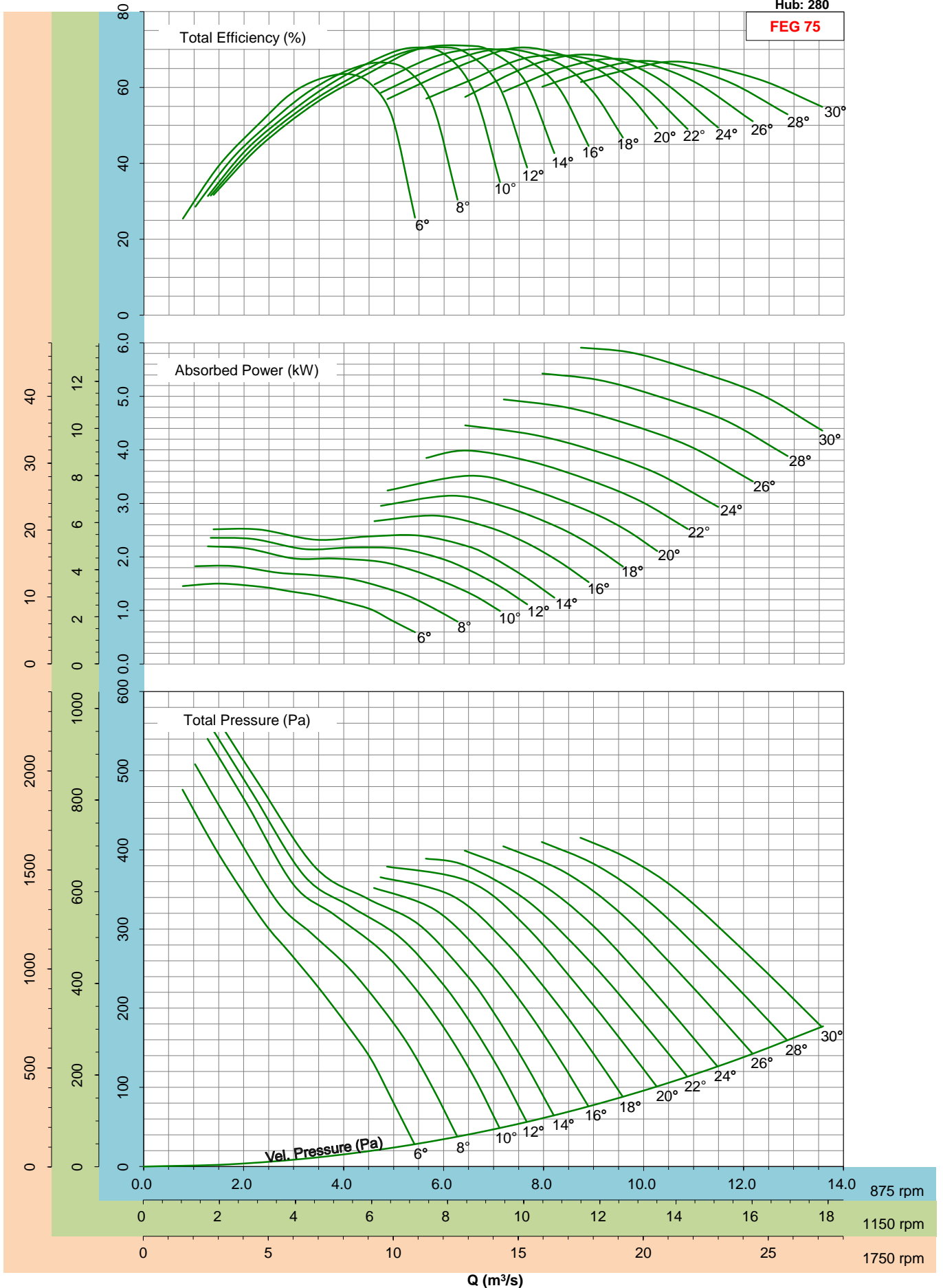

- Performance certified is for installation type D - ducted inlet, ducted outlet. Performance ratings do not include the effects of appurtenances (accessories).
- Please consult the nearest Kruger office for fan selection at 1750rpm.

$\rho=1.2\text{kg/m}^3$
Hub: 315

FEG 75

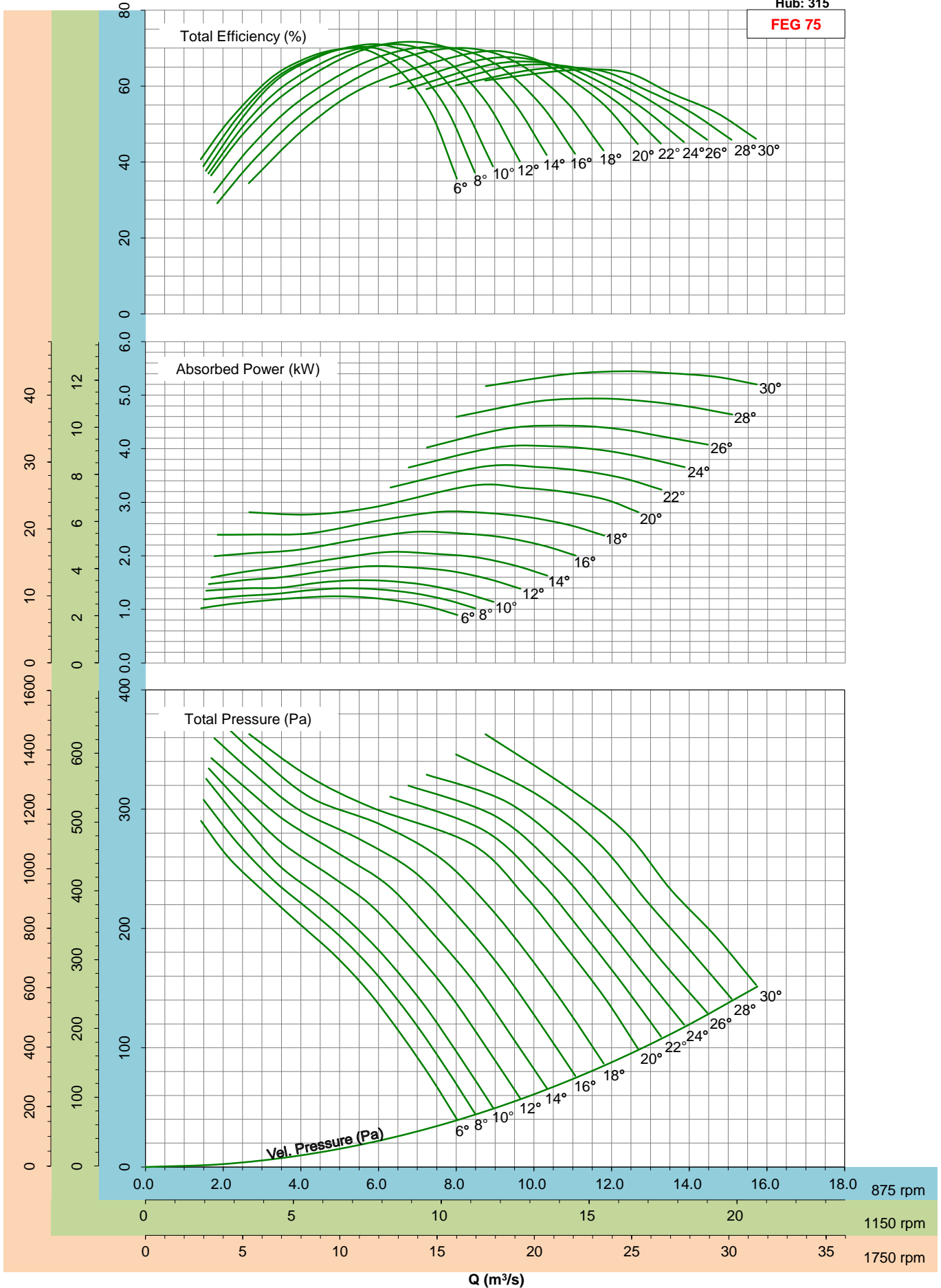

- Performance certified is for installation type D - ducted inlet, ducted outlet. Performance ratings do not include the effects of appurtenances (accessories).

- Please consult the nearest Kruger office for fan selection at 1750rpm.

$\rho=1.2\text{kg/m}^3$
Hub: 315

FEG 75

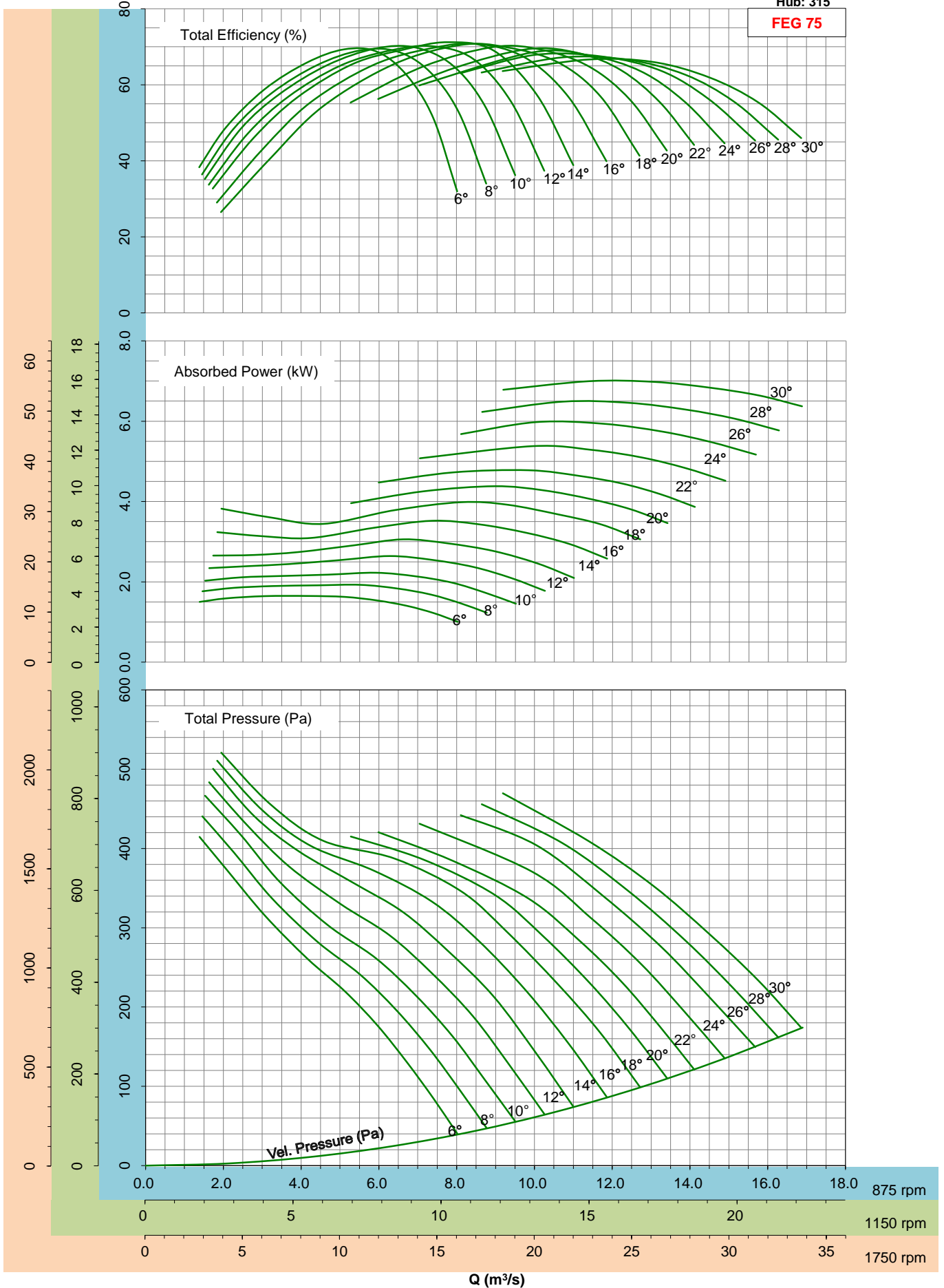

- Performance certified is for installation type D - ducted inlet, ducted outlet. Performance ratings do not include the effects of appurtenances (accessories).

- Please consult the nearest Kruger office for fan selection at 1750rpm.

$\rho=1.2\text{kg/m}^3$
Hub: 315

FEG 75

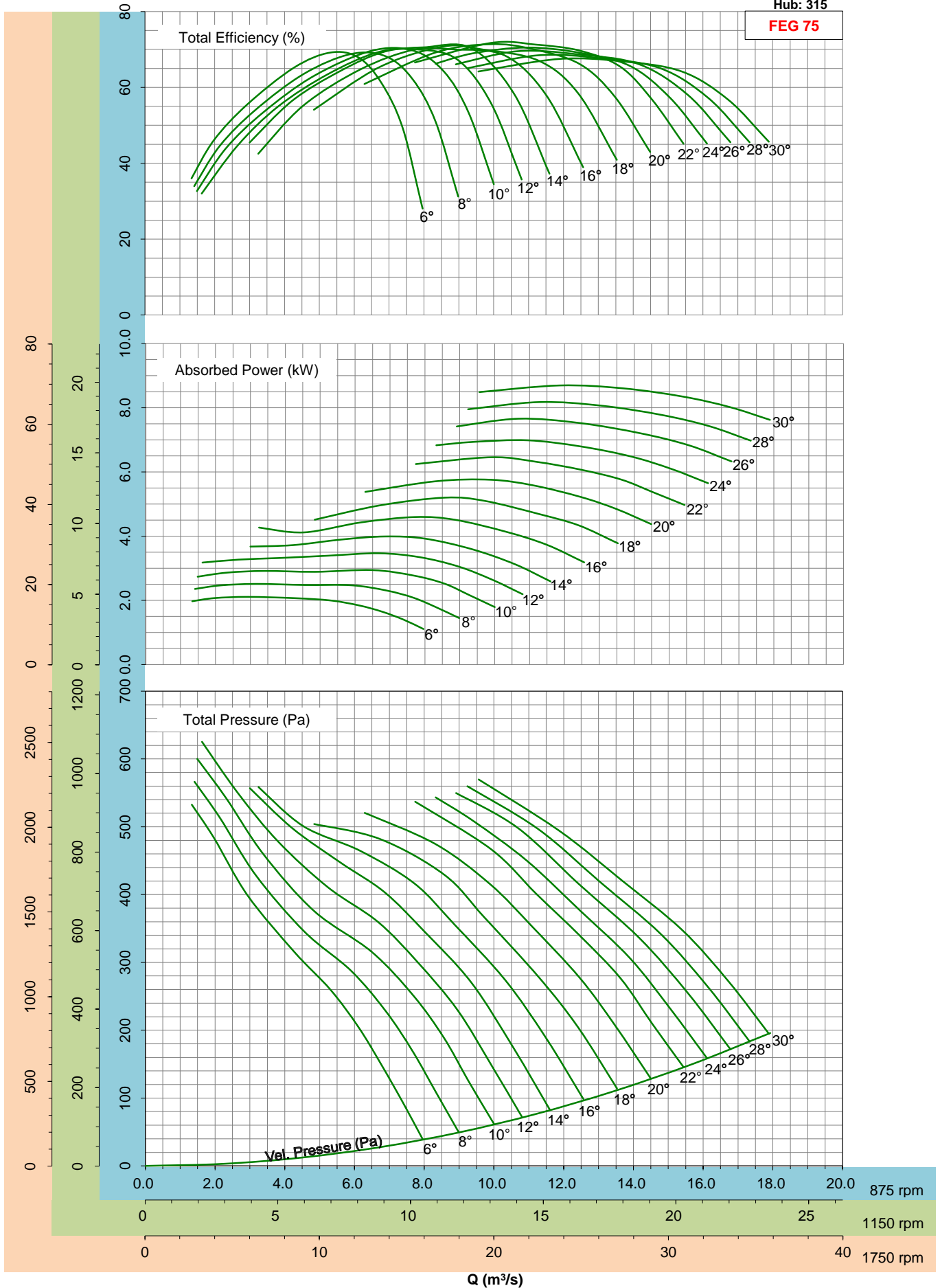

- Performance certified is for installation type D - ducted inlet, ducted outlet. Performance ratings do not include the effects of appurtenances (accessories).

- Please consult the nearest Kruger office for fan selection at 1750rpm.

$\rho=1.2\text{kg/m}^3$
Hub: 315

FEG 75

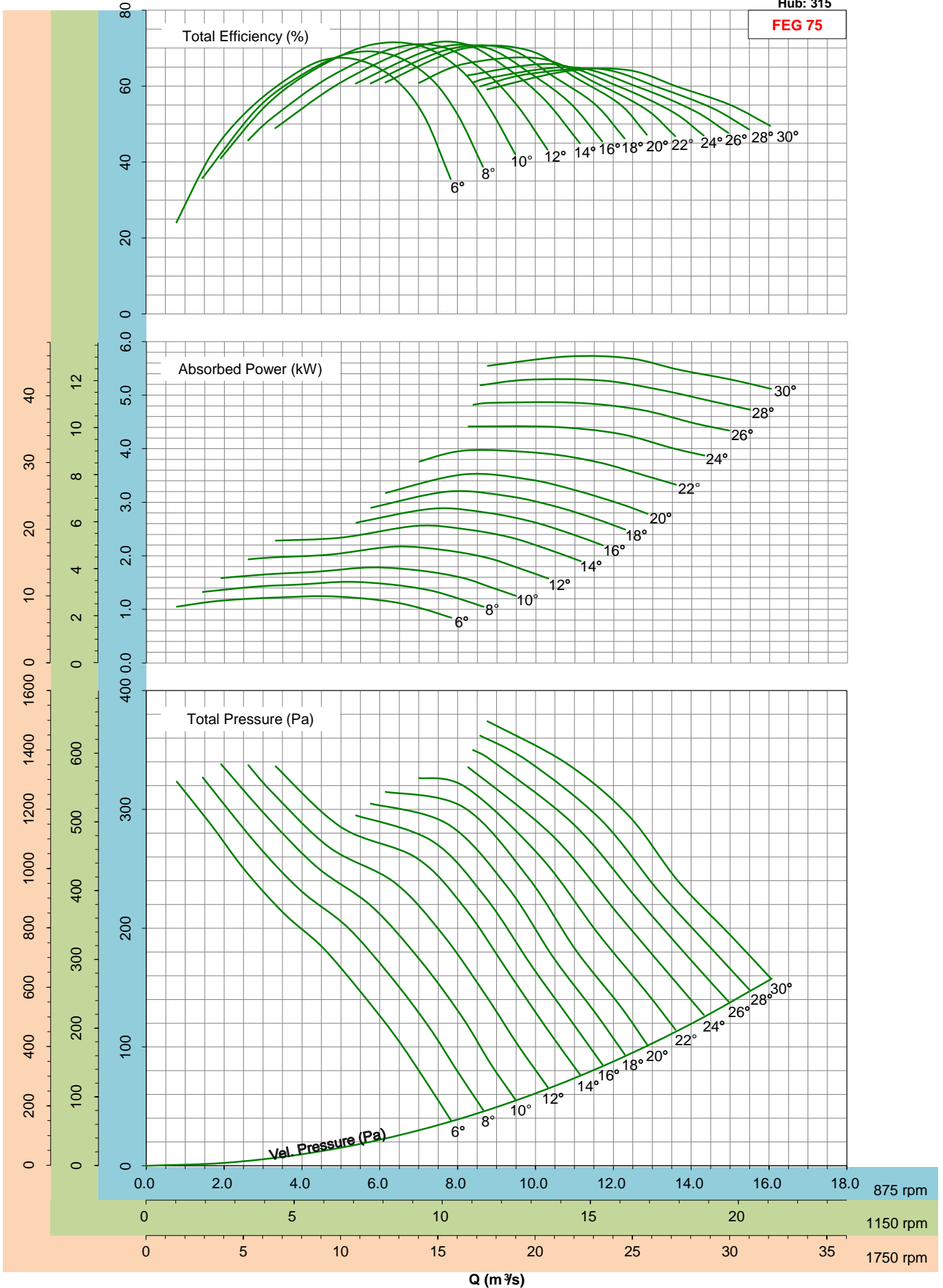

- Performance certified is for installation type D - ducted inlet, ducted outlet. Performance ratings do not include the effects of appurtenances (accessories).

- Please consult the nearest Kruger office for fan selection at 1750rpm.

$\rho=1.2\text{kg/m}^3$
Hub: 315

FEG 75

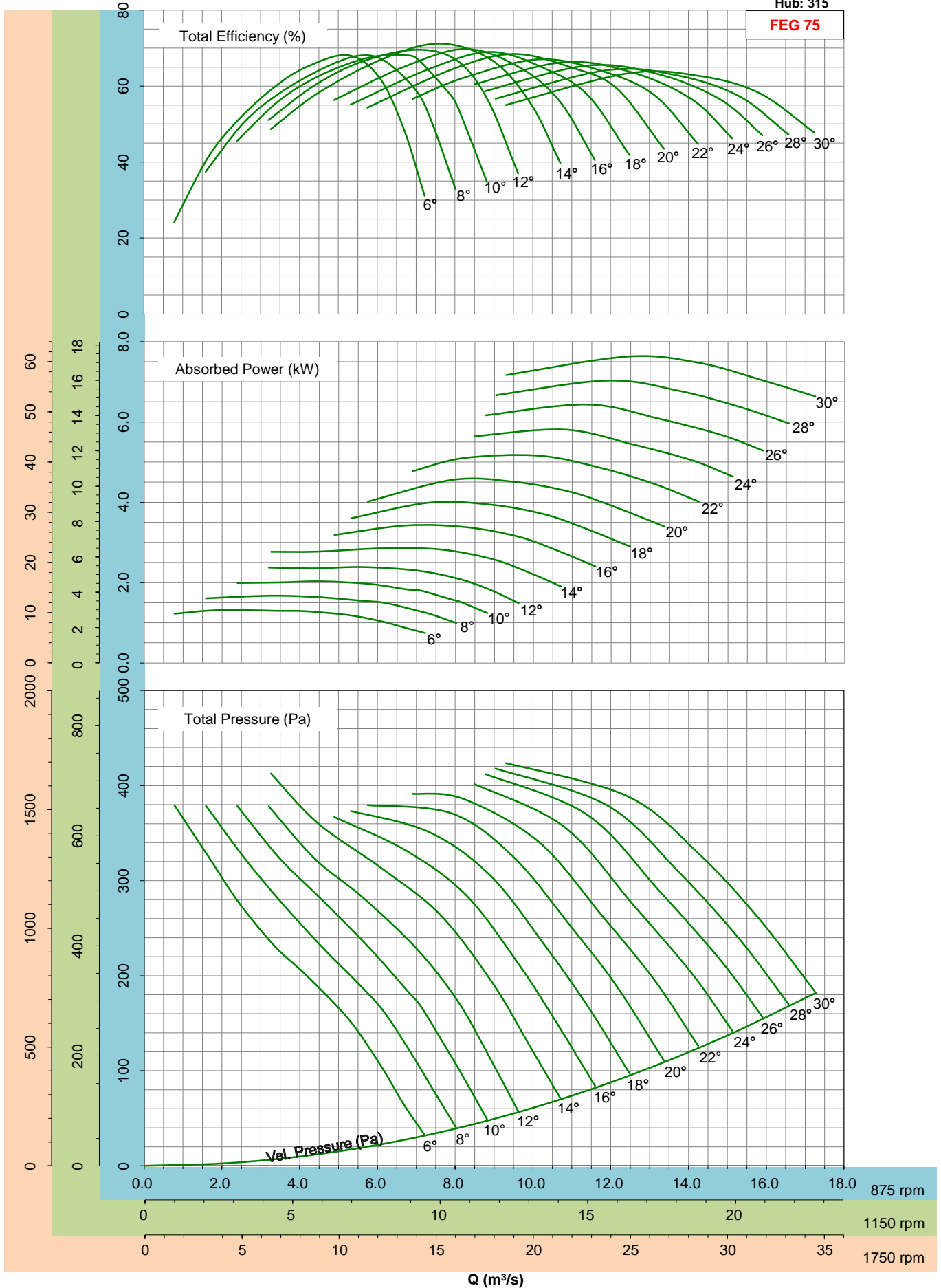

- Performance certified is for installation type D - ducted inlet, ducted outlet. Performance ratings do not include the effects of appurtenances (accessories).

- Please consult the nearest Kruger office for fan selection at 1750rpm.

$\rho=1.2\text{kg/m}^3$
Hub: 315

FEG 75

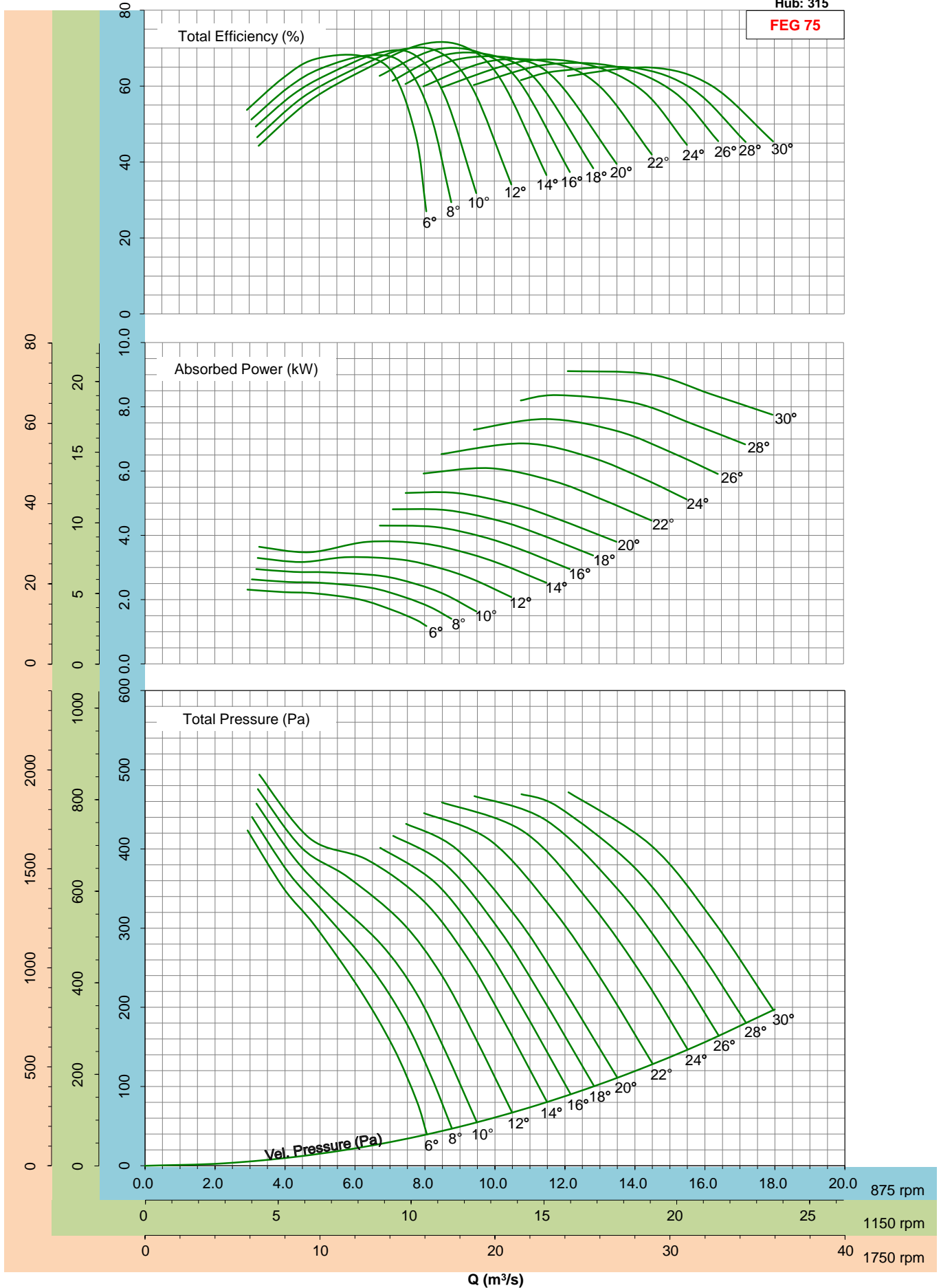

- Performance certified is for installation type D - ducted inlet, ducted outlet. Performance ratings do not include the effects of appurtenances (accessories).

- Please consult the nearest Kruger office for fan selection at 1750rpm.

$\rho=1.2\text{kg/m}^3$
Hub: 353

FEG 75

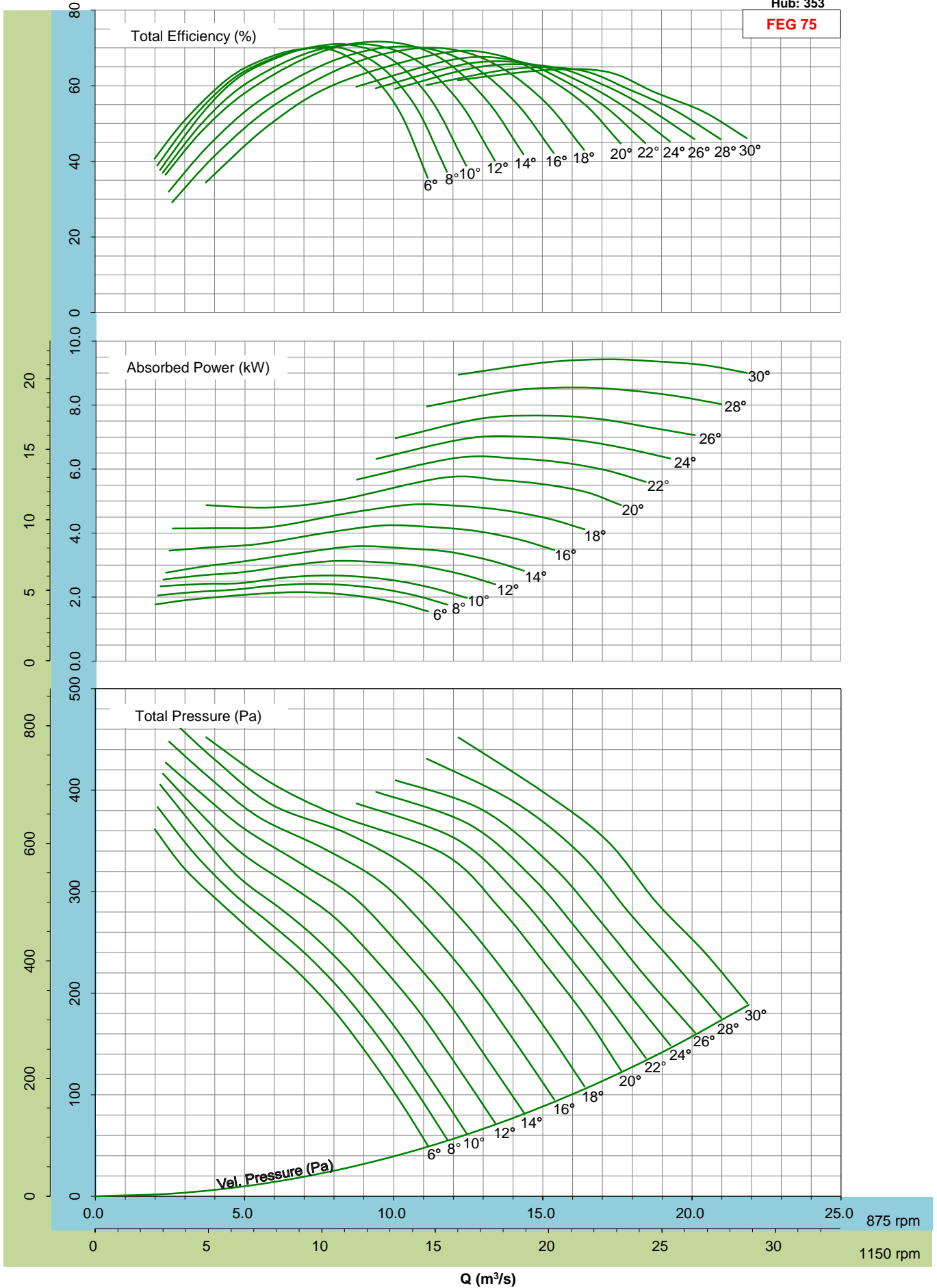

- Performance certified is for installation type D - ducted inlet, ducted outlet. Performance ratings do not include the effects of appurtenances (accessories).

$\rho=1.2\text{kg/m}^3$
Hub: 353

FEG 75

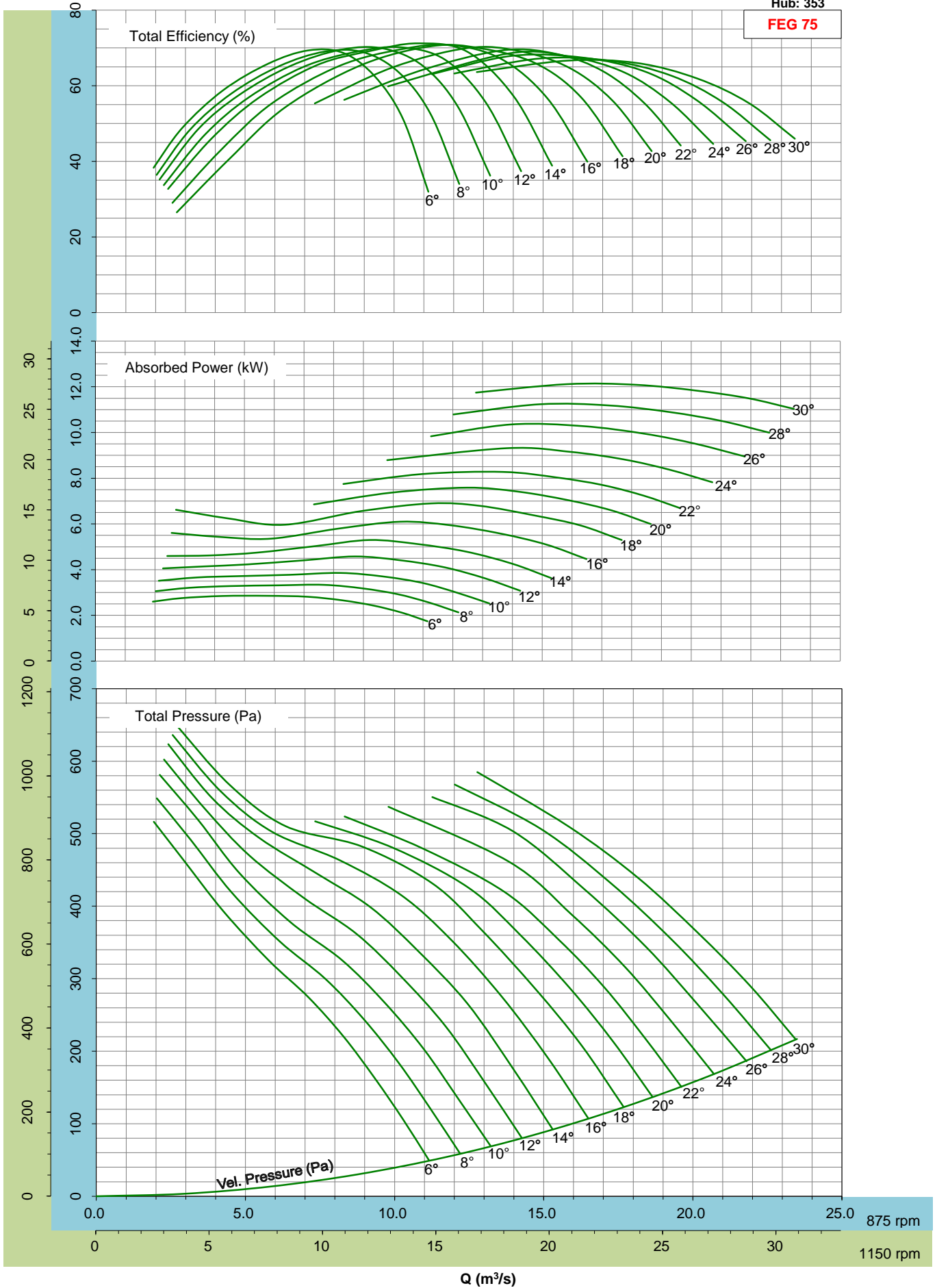

- Performance certified is for installation type D - ducted inlet, ducted outlet. Performance ratings do not include the effects of appurtenances (accessories).

$\rho=1.2\text{kg/m}^3$
Hub: 353

FEG 75

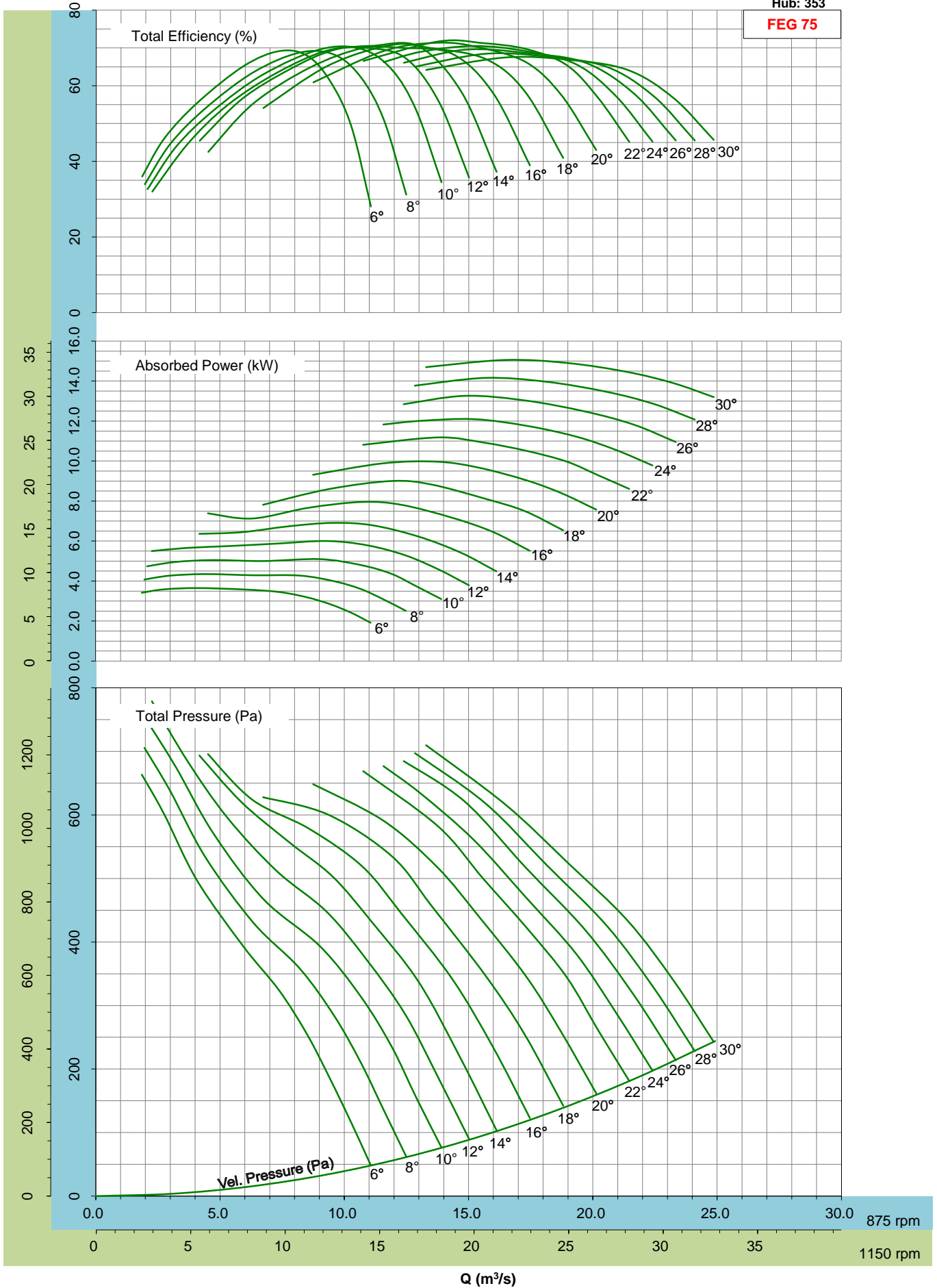

- Performance certified is for installation type D - ducted inlet, ducted outlet. Performance ratings do not include the effects of appurtenances (accessories).

$\rho=1.2\text{kg/m}^3$
Hub: 353

FEG 75

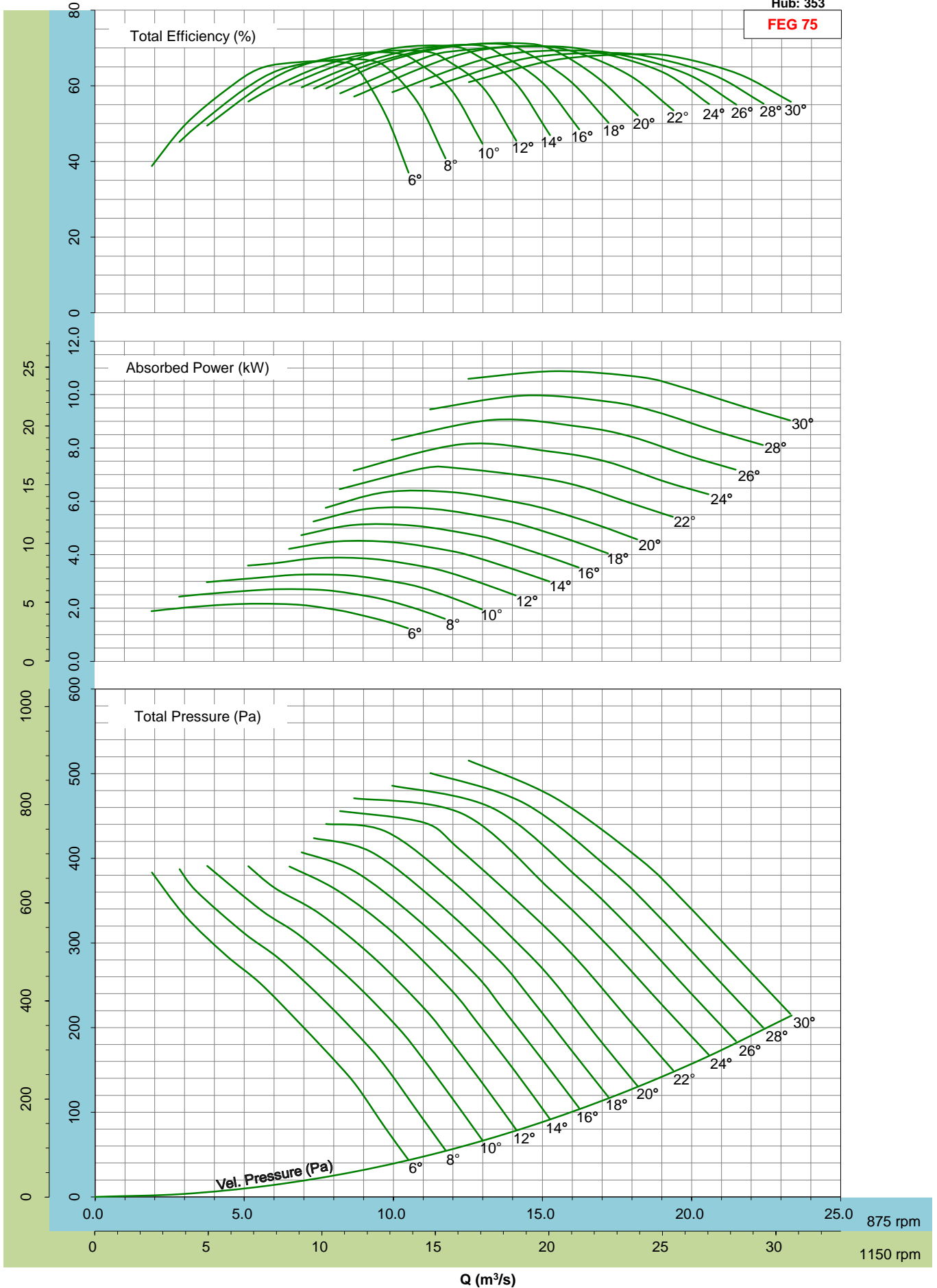

- Performance certified is for installation type D - ducted inlet, ducted outlet. Performance ratings do not include the effects of appurtenances (accessories).

$\rho=1.2\text{kg/m}^3$
Hub: 353

FEG 75

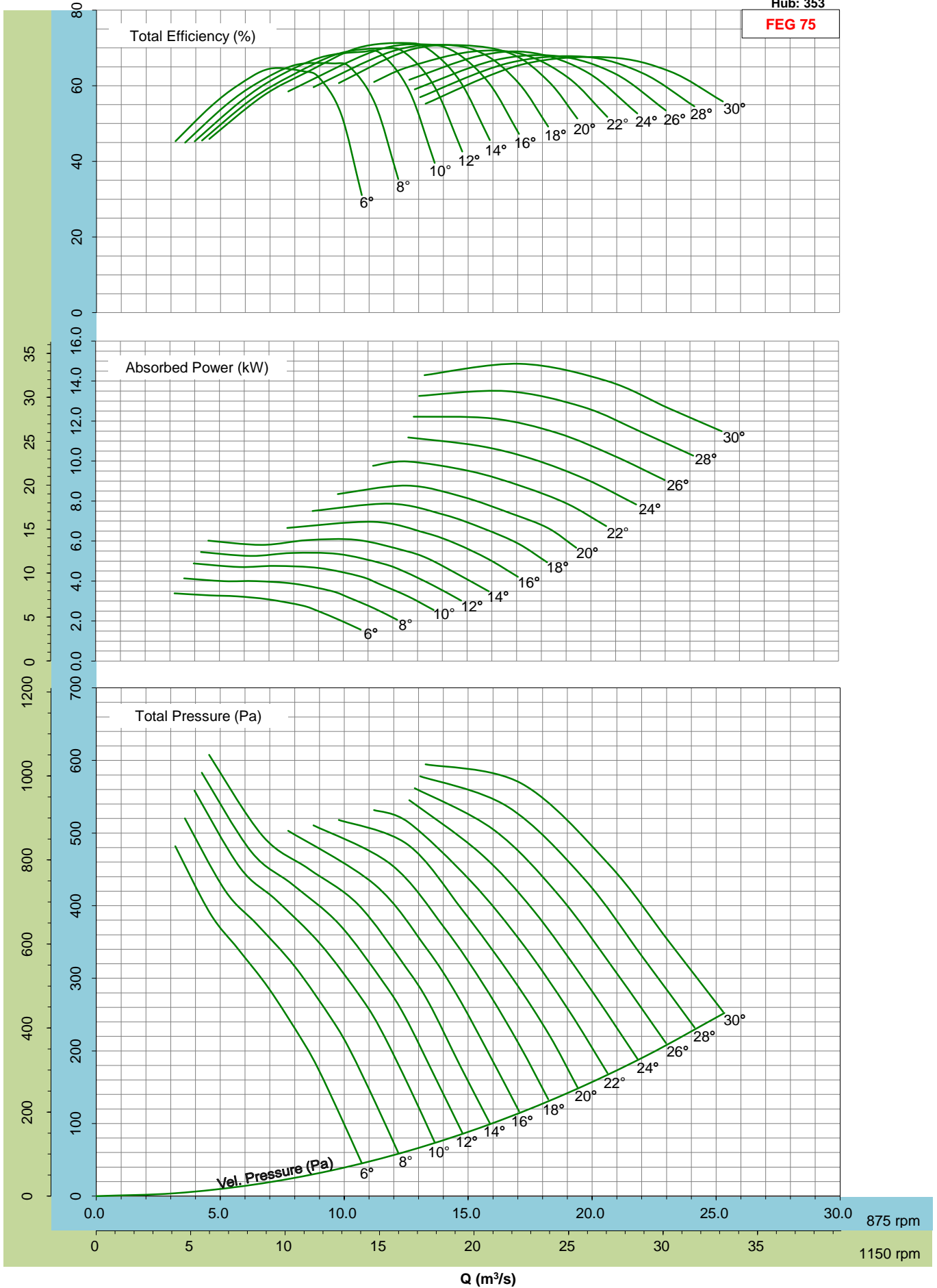

- Performance certified is for installation type D - ducted inlet, ducted outlet. Performance ratings do not include the effects of appurtenances (accessories).

$\rho=1.2\text{kg/m}^3$
Hub: 353

FEG 75

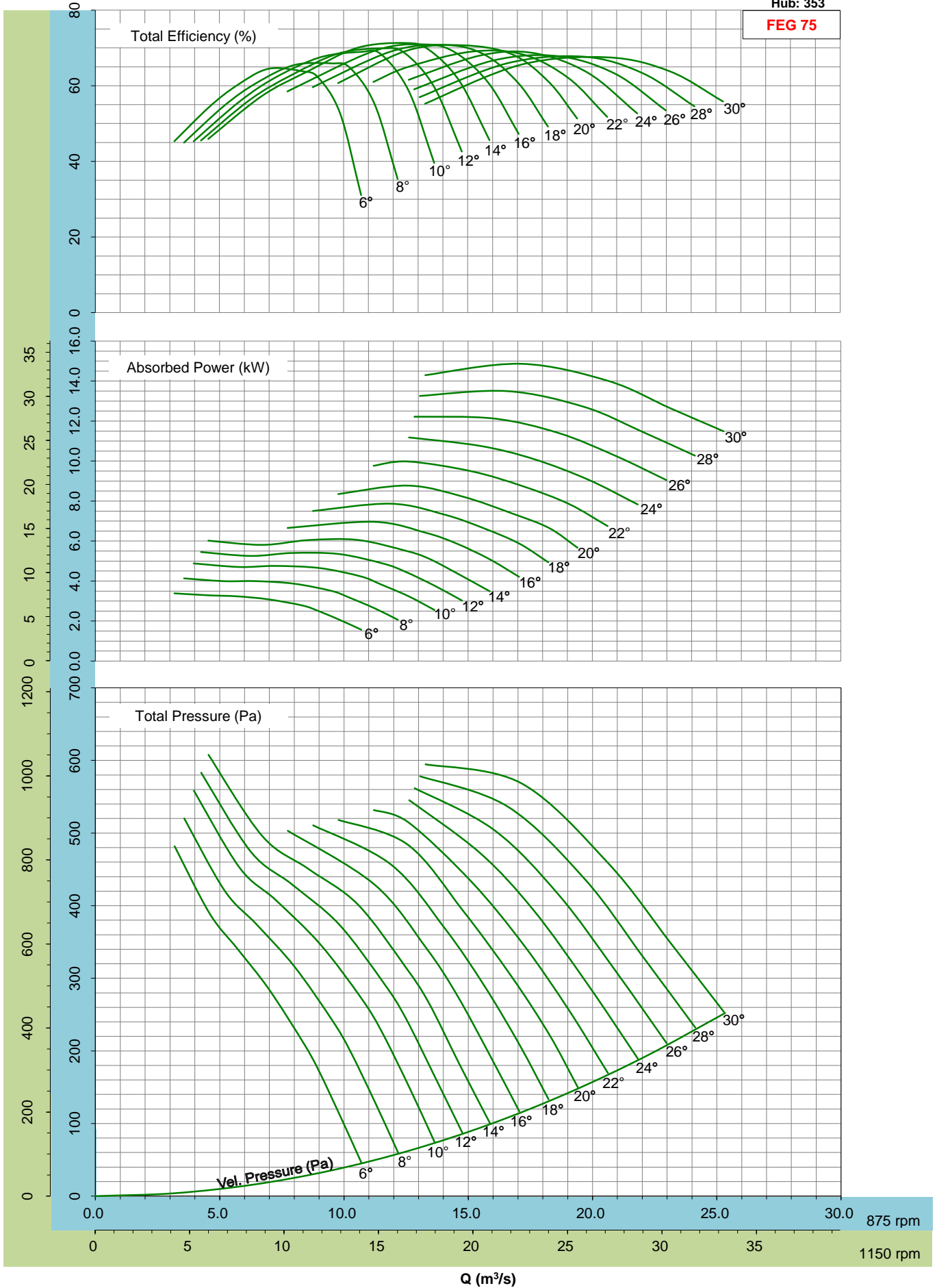

- Performance certified is for installation type D - ducted inlet, ducted outlet. Performance ratings do not include the effects of appurtenances (accessories).

$\rho=1.2\text{kg/m}^3$
Hub: 397

FEG 75

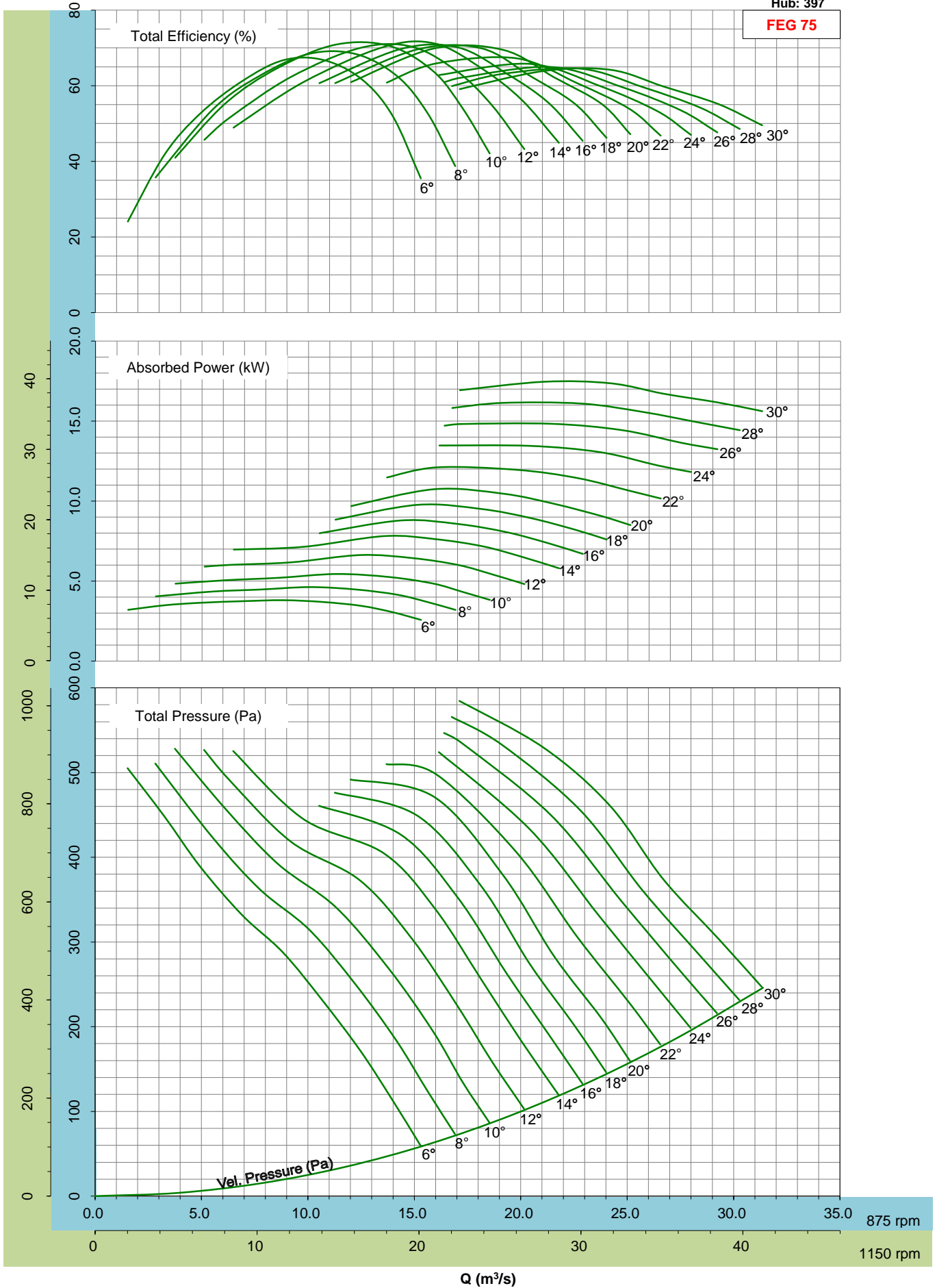

- Performance certified is for installation type D - ducted inlet, ducted outlet. Performance ratings do not include the effects of appurtenances (accessories).

$\rho=1.2\text{kg/m}^3$
Hub: 397

FEG 75

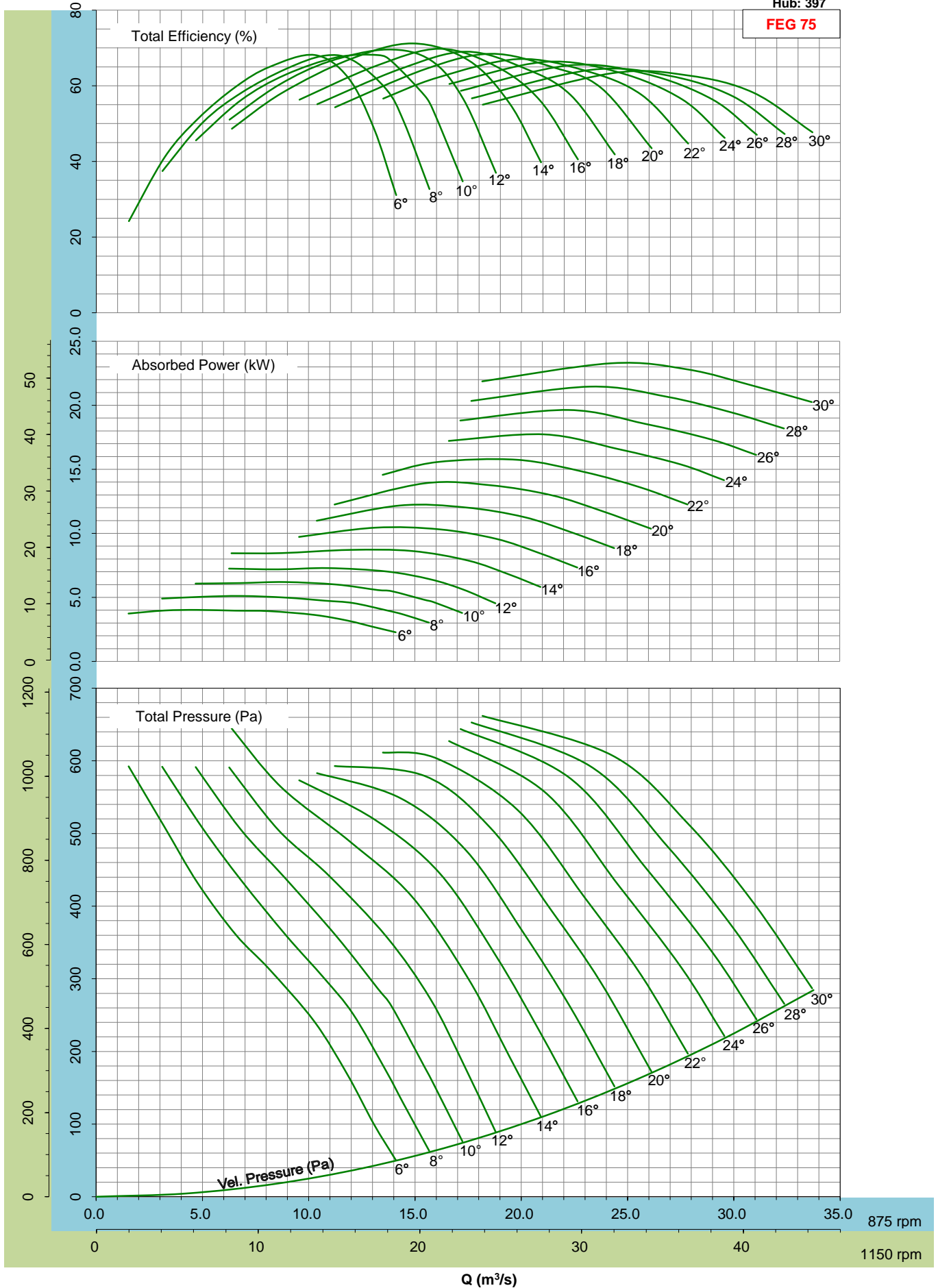

- Performance certified is for installation type D - ducted inlet, ducted outlet. Performance ratings do not include the effects of appurtenances (accessories).

$\rho=1.2\text{kg/m}^3$
Hub: 397

FEG 75

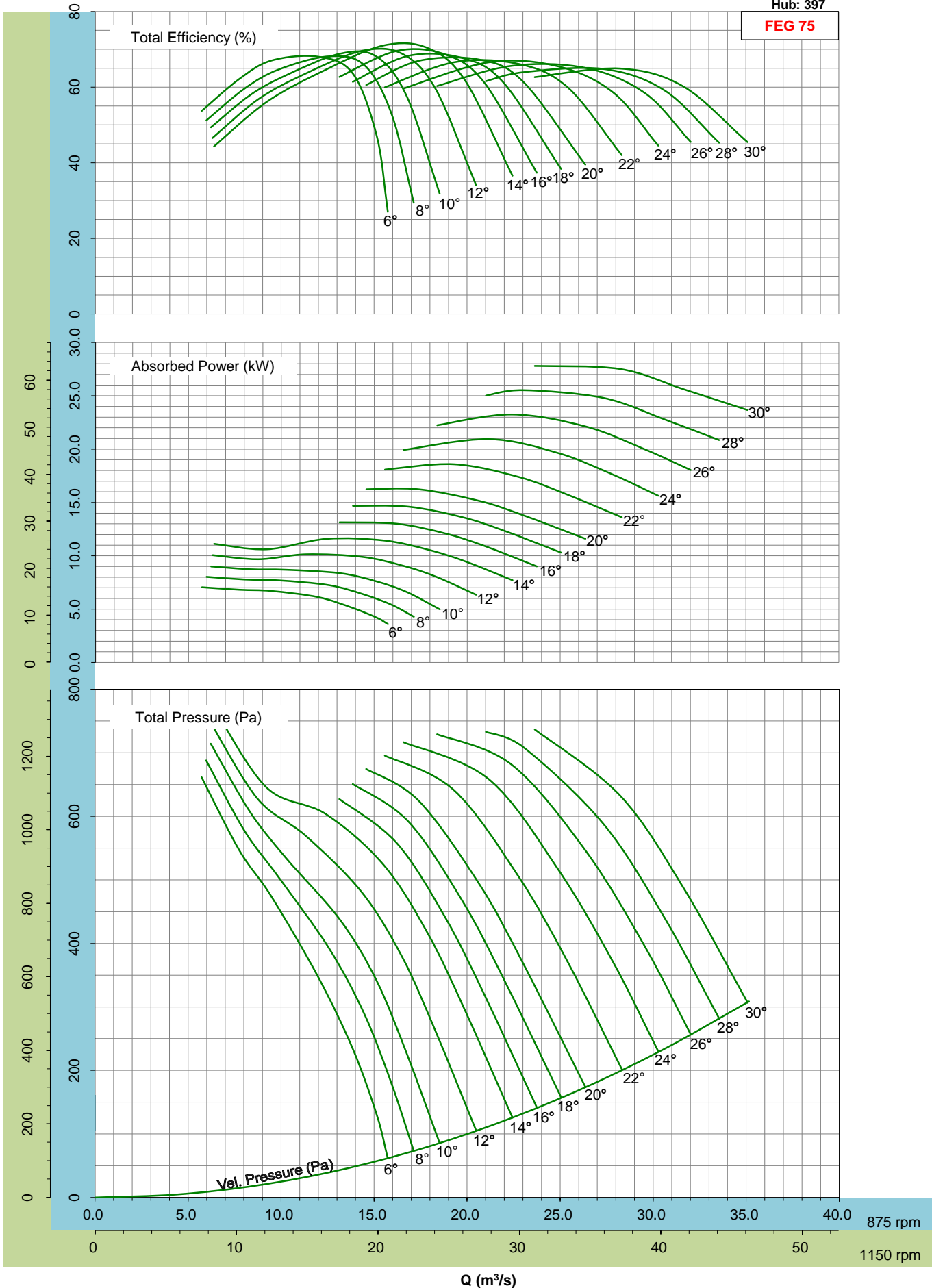

- Performance certified is for installation type D - ducted inlet, ducted outlet. Performance ratings do not include the effects of appurtenances (accessories).

$\rho=1.2\text{kg/m}^3$
Hub: 450

FEG 75

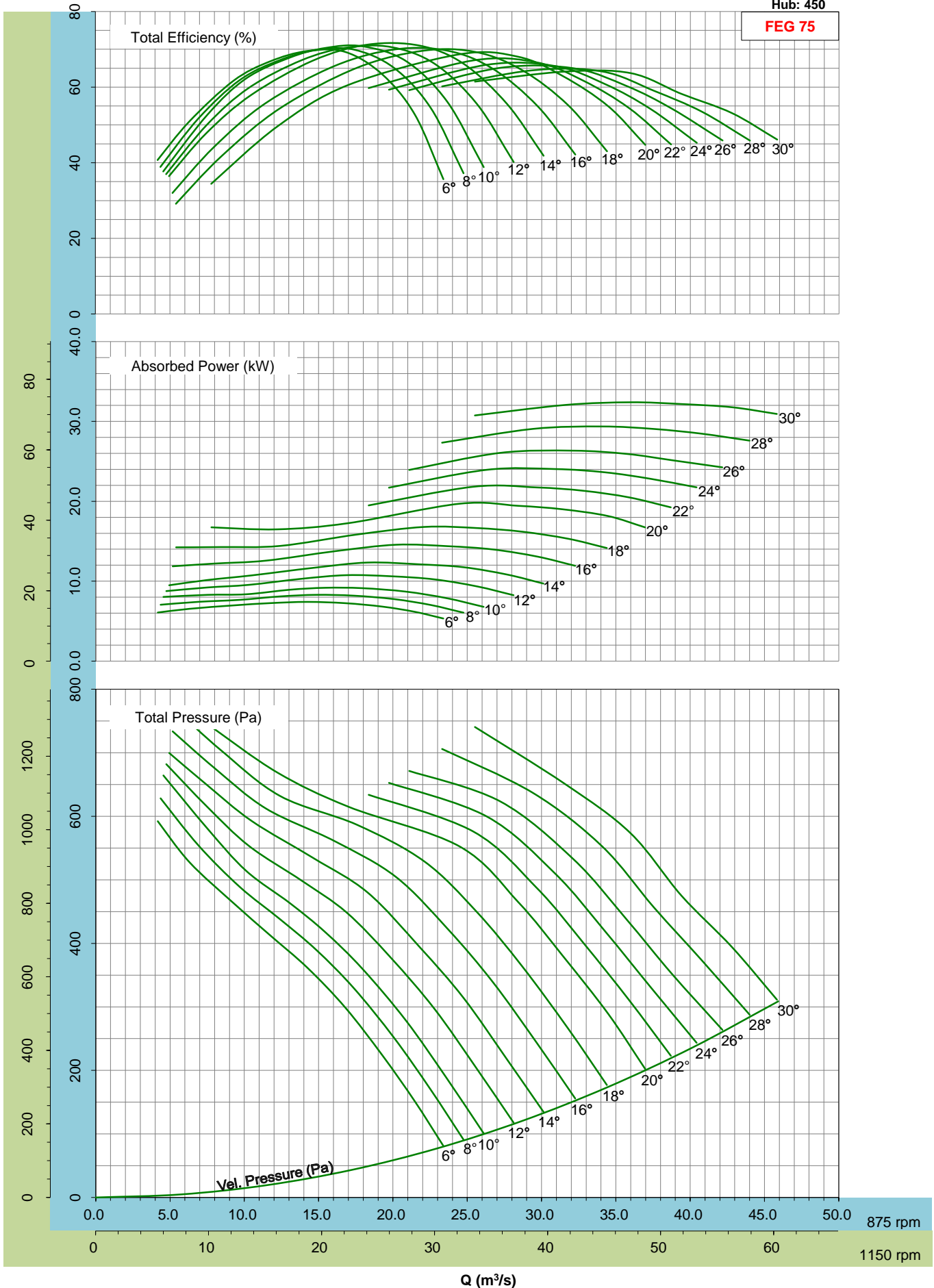

- Performance certified is for installation type D - ducted inlet, ducted outlet. Performance ratings do not include the effects of appurtenances (accessories).
- Please consult the nearest Kruger office for fan selection at 1150rpm.

$\rho=1.2\text{kg/m}^3$
Hub: 450

FEG 75

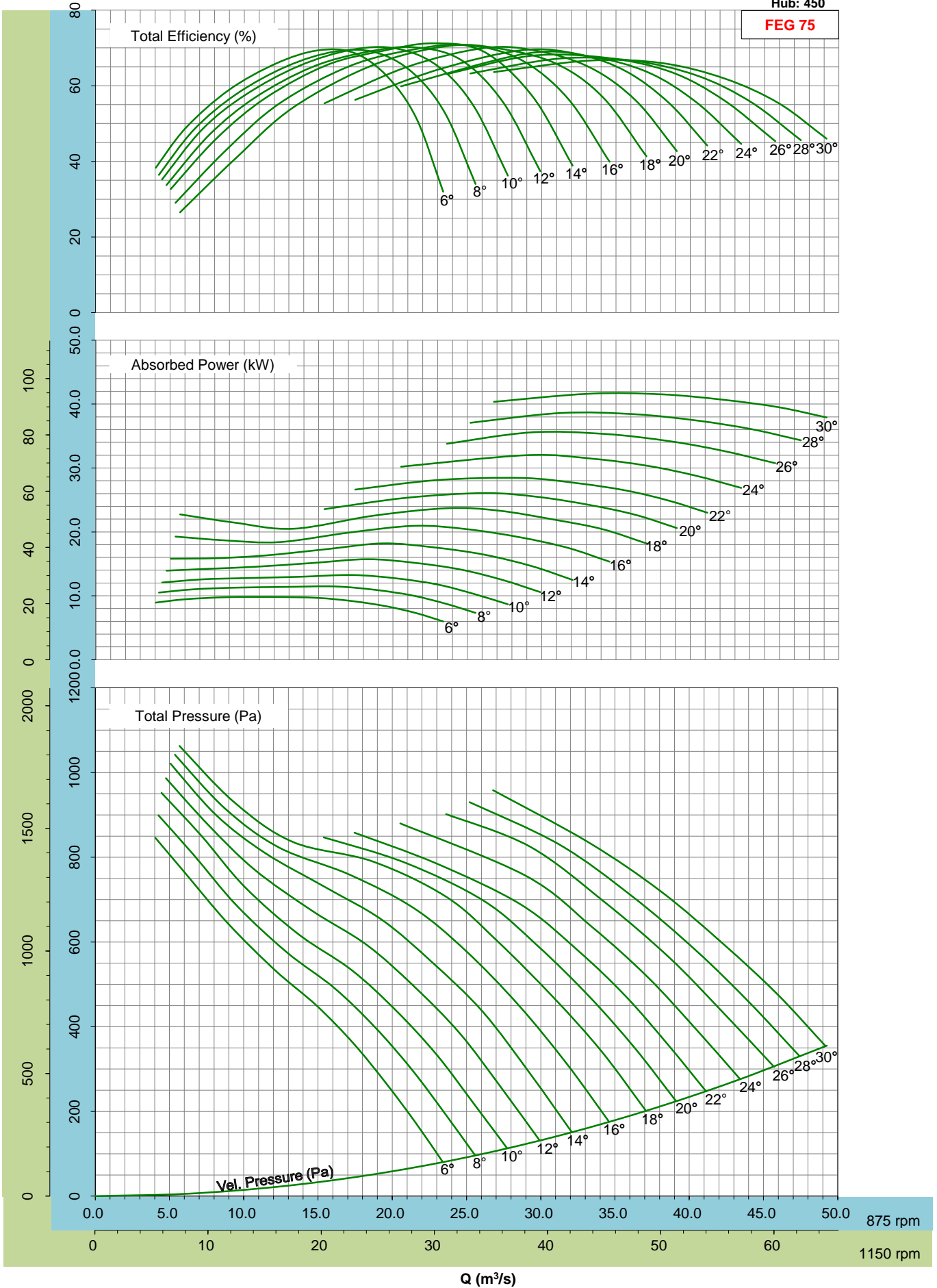

- Performance certified is for installation type D - ducted inlet, ducted outlet. Performance ratings do not include the effects of appurtenances (accessories).
- Please consult the nearest Kruger office for fan selection at 1150rpm.

$\rho=1.2\text{kg/m}^3$
Hub: 450

FEG 75

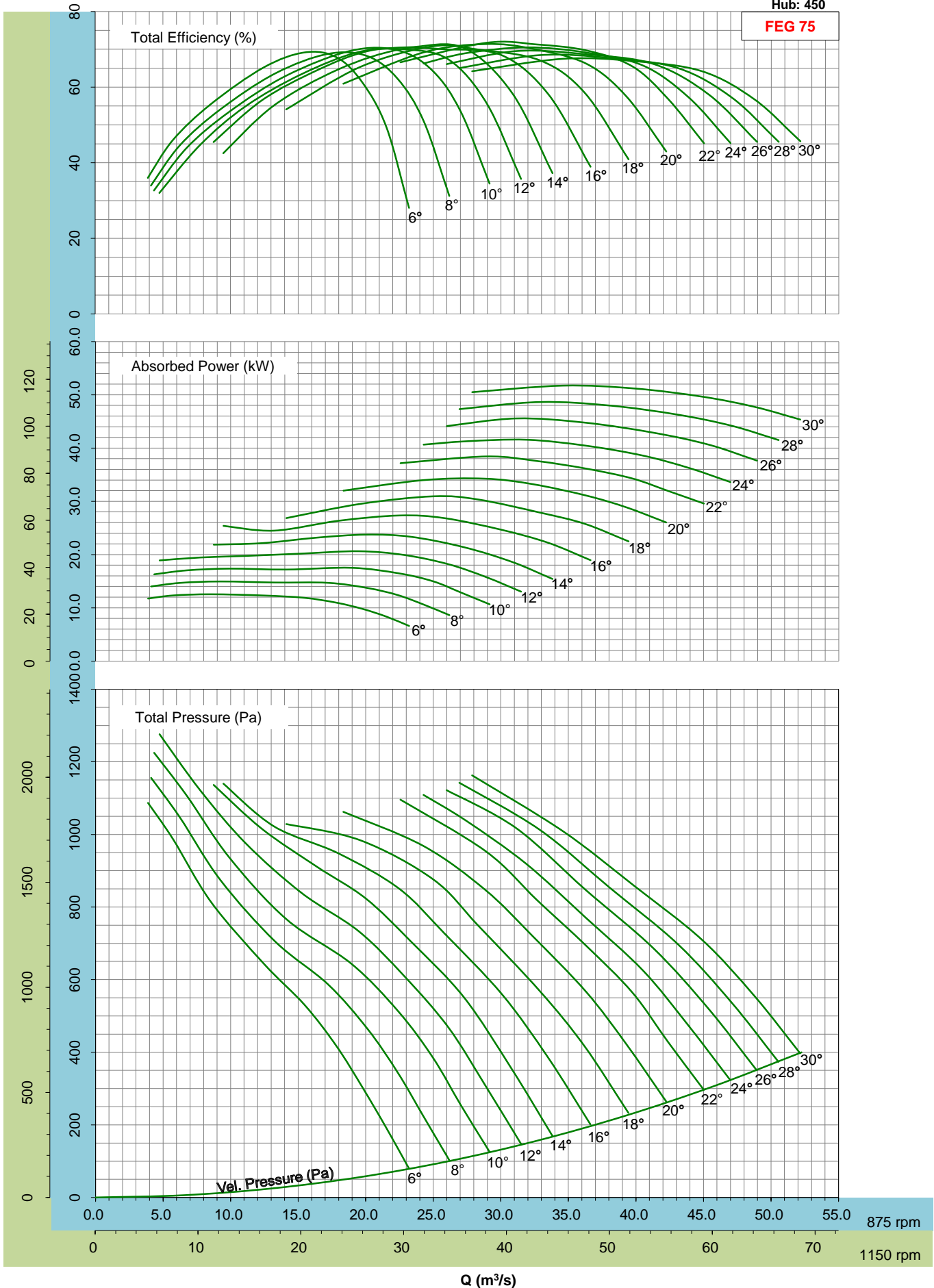

- Performance certified is for installation type D - ducted inlet, ducted outlet. Performance ratings do not include the effects of appurtenances (accessories).
- Please consult the nearest Kruger office for fan selection at 1150rpm.

$\rho=1.2\text{kg/m}^3$
Hub: 450

FEG 75

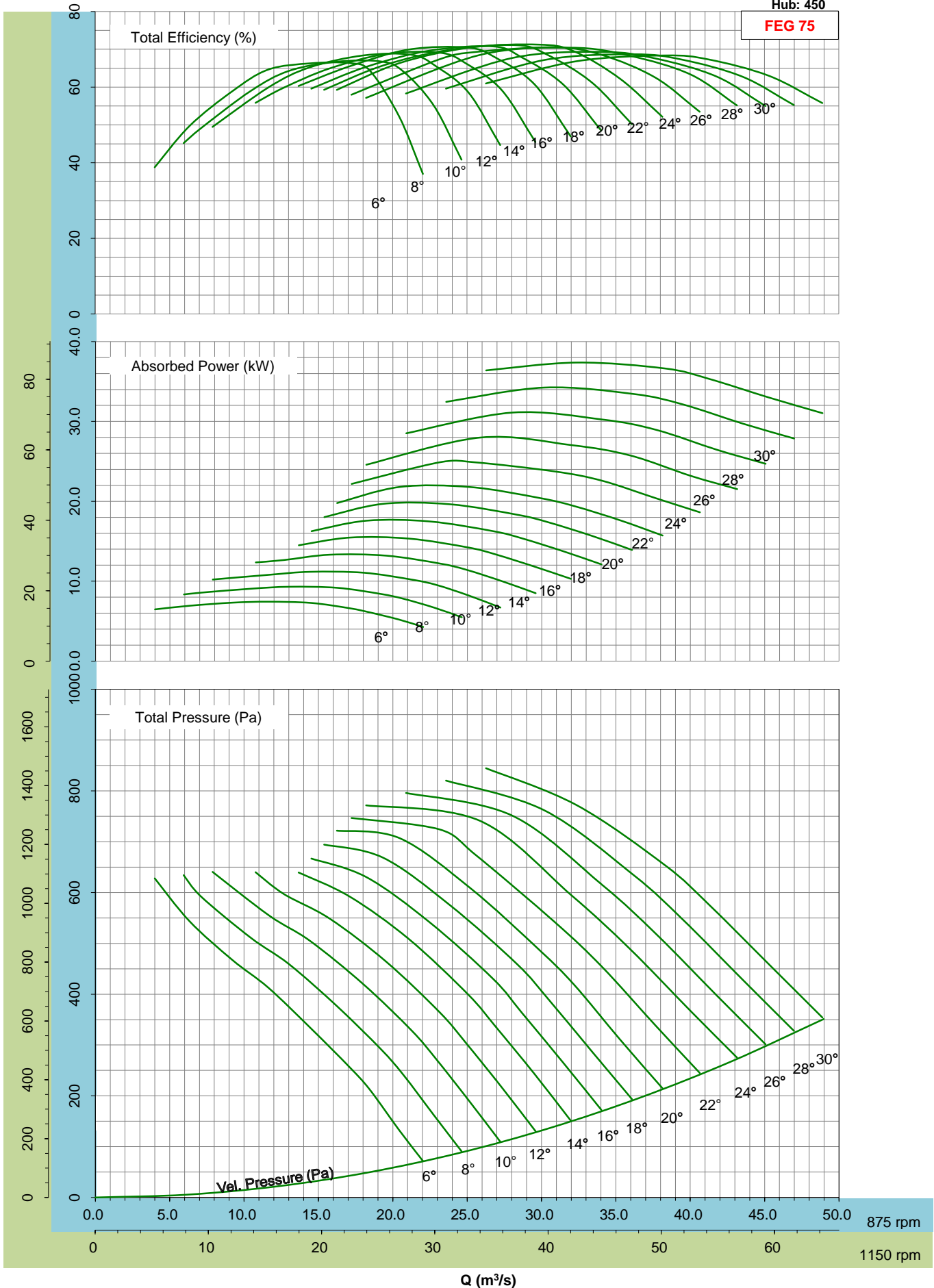

- Performance certified is for installation type D - ducted inlet, ducted outlet. Performance ratings do not include the effects of appurtenances (accessories).
 - Please consult the nearest Kruger office for fan selection at 1150rpm.

$\rho=1.2\text{kg/m}^3$
Hub: 450

FEG 75

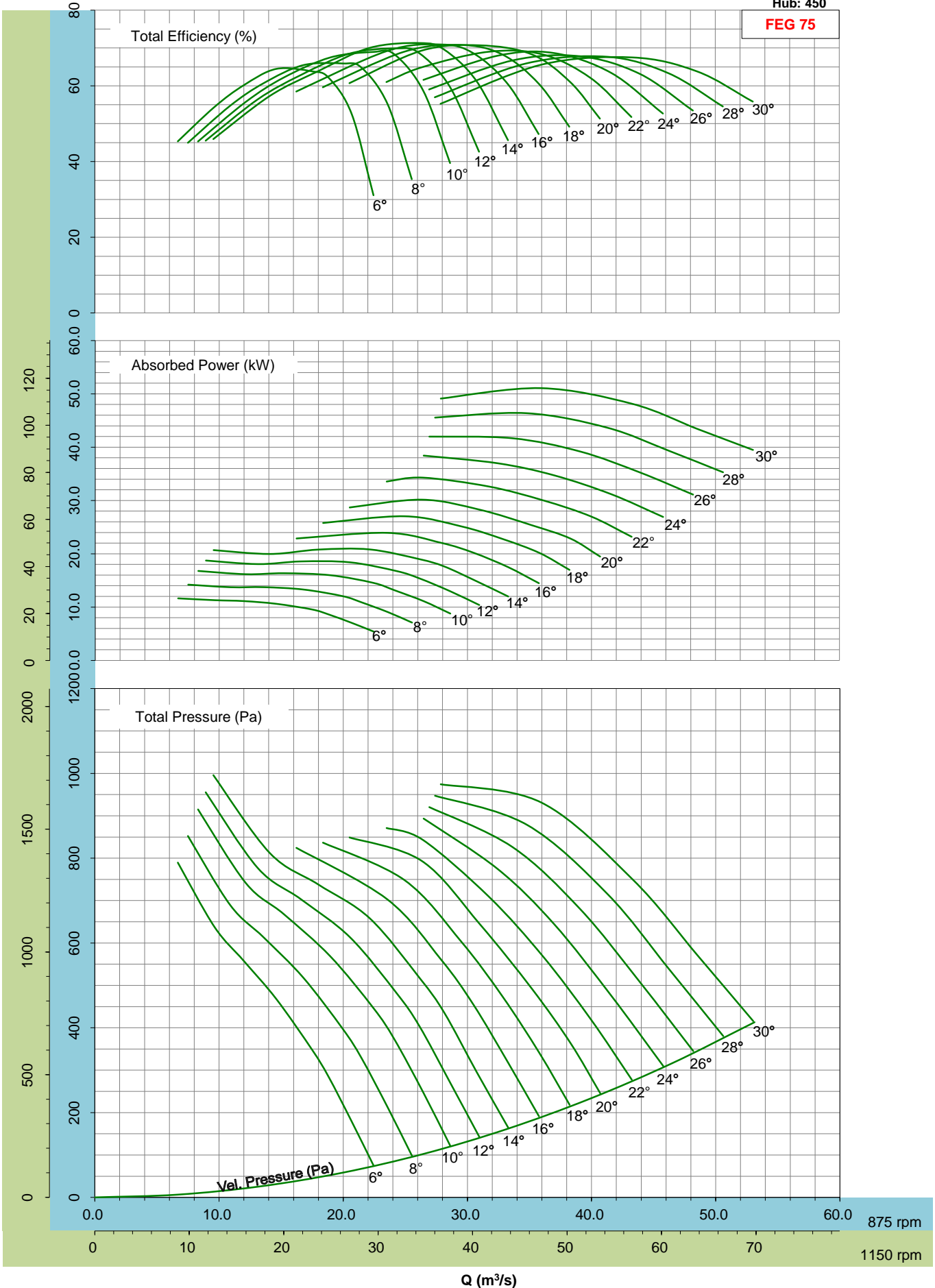

- Performance certified is for installation type D - ducted inlet, ducted outlet. Performance ratings do not include the effects of appurtenances (accessories).
- Please consult the nearest Kruger office for fan selection at 1150rpm.

$\rho=1.2\text{kg/m}^3$
Hub: 450

FEG 75

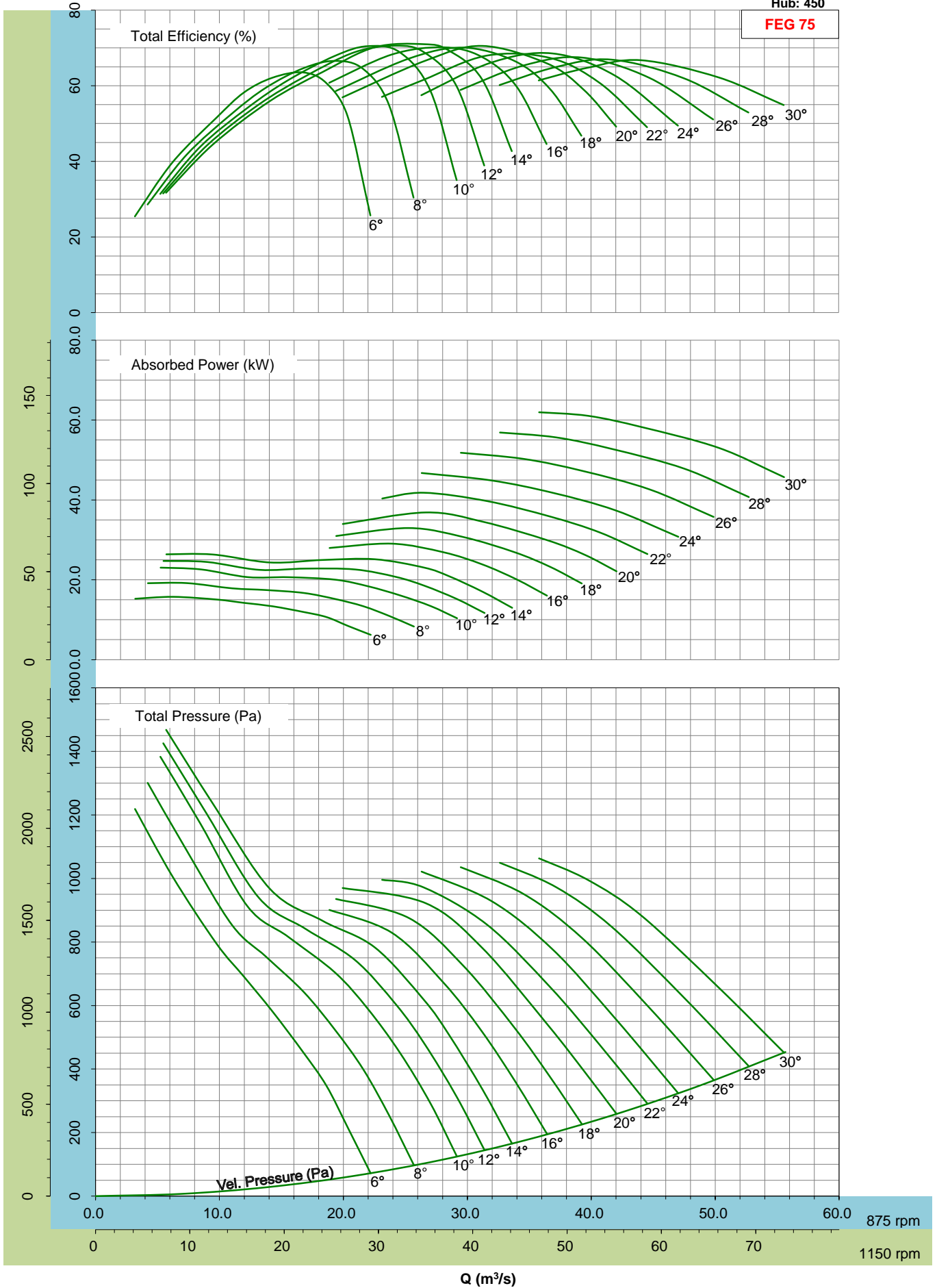

- Performance certified is for installation type D - ducted inlet, ducted outlet. Performance ratings do not include the effects of appurtenances (accessories).
 - Please consult the nearest Kruger office for fan selection at 1150rpm.

$\rho=1.2\text{kg/m}^3$
Hub: 502

FEG 75

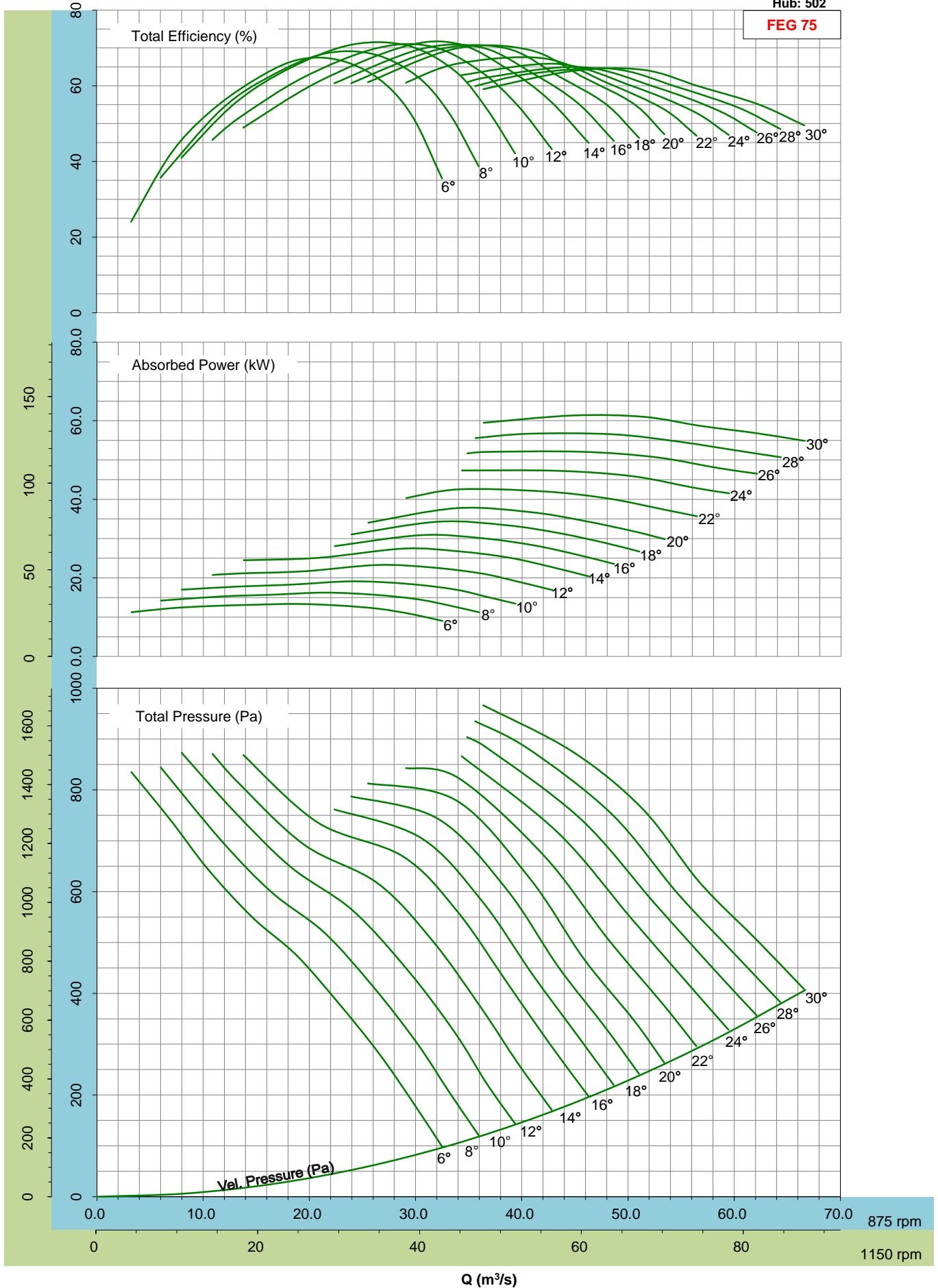

- Performance certified is for installation type D - ducted inlet, ducted outlet. Performance ratings do not include the effects of appurtenances (accessories).
- Please consult the nearest Kruger office for fan selection at 1150rpm.

$\rho=1.2\text{kg/m}^3$
Hub: 502

FEG 75

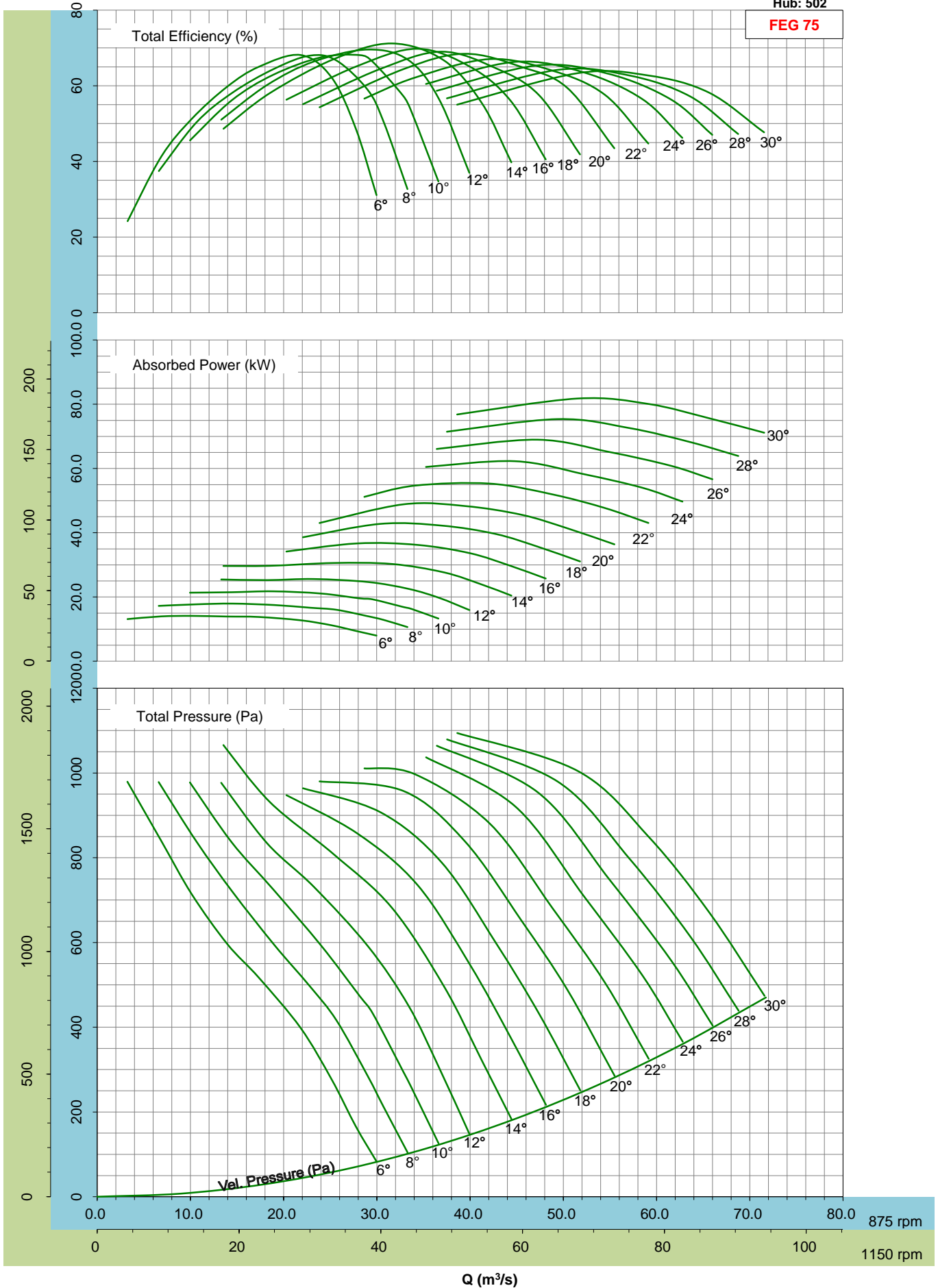

- Performance certified is for installation type D - ducted inlet, ducted outlet. Performance ratings do not include the effects of appurtenances (accessories).

- Please consult the nearest Kruger office for fan selection at 1150rpm.

$\rho=1.2\text{kg/m}^3$
Hub: 502

FEG 75

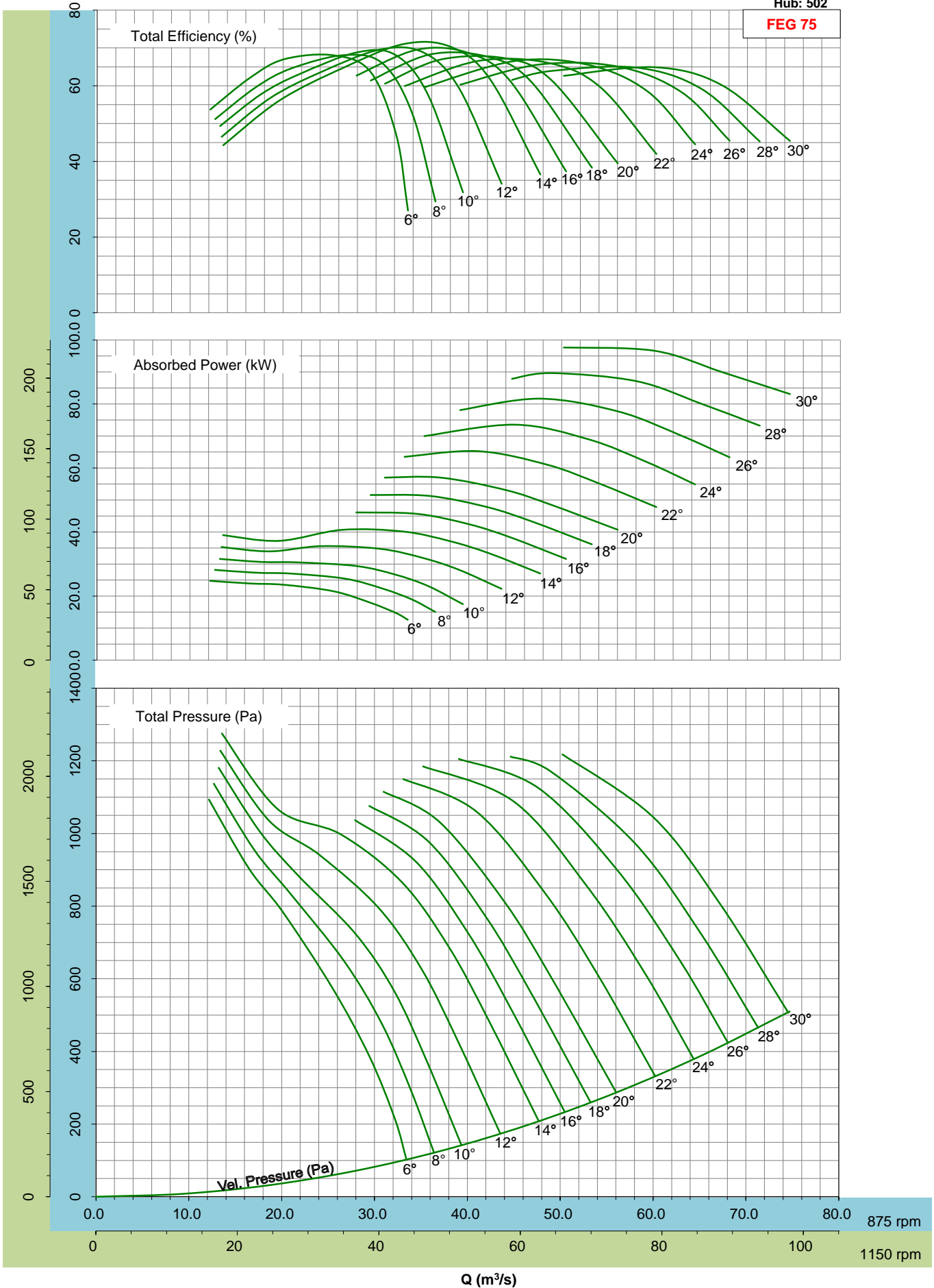

- Performance certified is for installation type D - ducted inlet, ducted outlet. Performance ratings do not include the effects of appurtenances (accessories).

- Please consult the nearest Kruger office for fan selection at 1150rpm.

$\rho=1.2\text{kg/m}^3$
Hub: 560

FEG 75

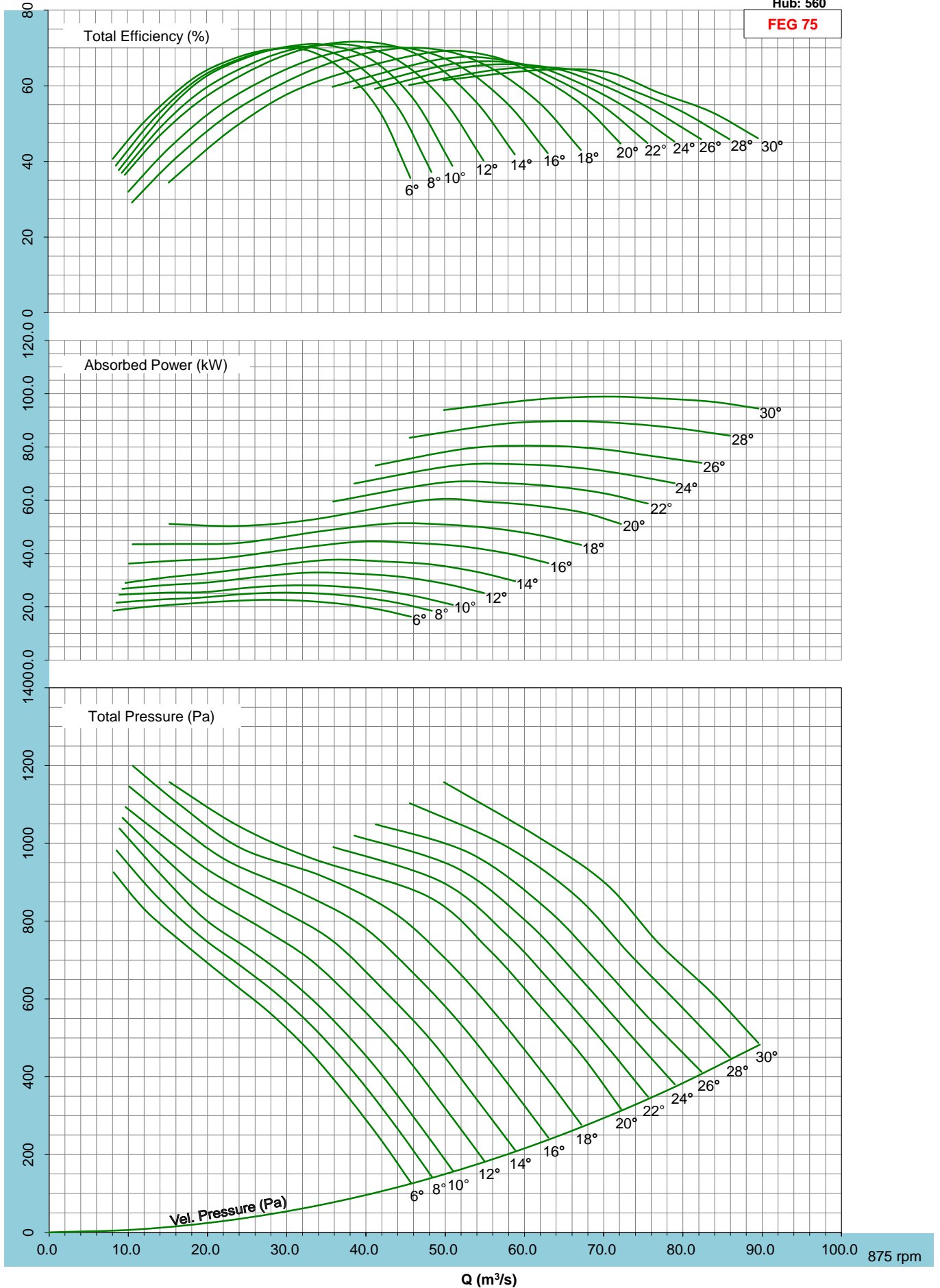

- Performance certified is for installation type D - ducted inlet, ducted outlet. Performance ratings do not include the effects of appurtenances (accessories).

$\rho=1.2\text{kg/m}^3$
Hub: 560

FEG 75

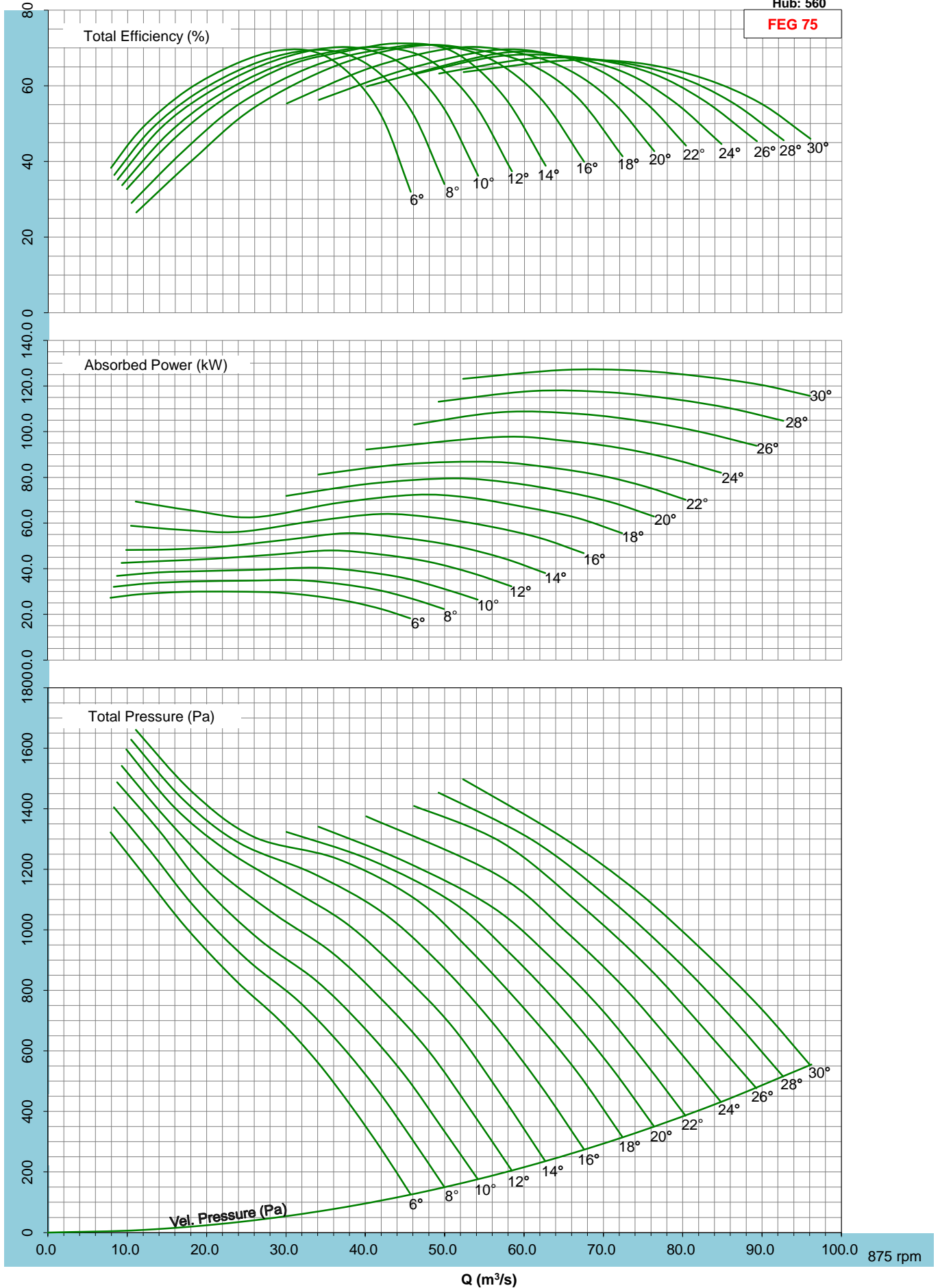

- Performance certified is for installation type D - ducted inlet, ducted outlet. Performance ratings do not include the effects of appurtenances (accessories).

$\rho=1.2\text{kg/m}^3$
Hub: 560

FEG 75

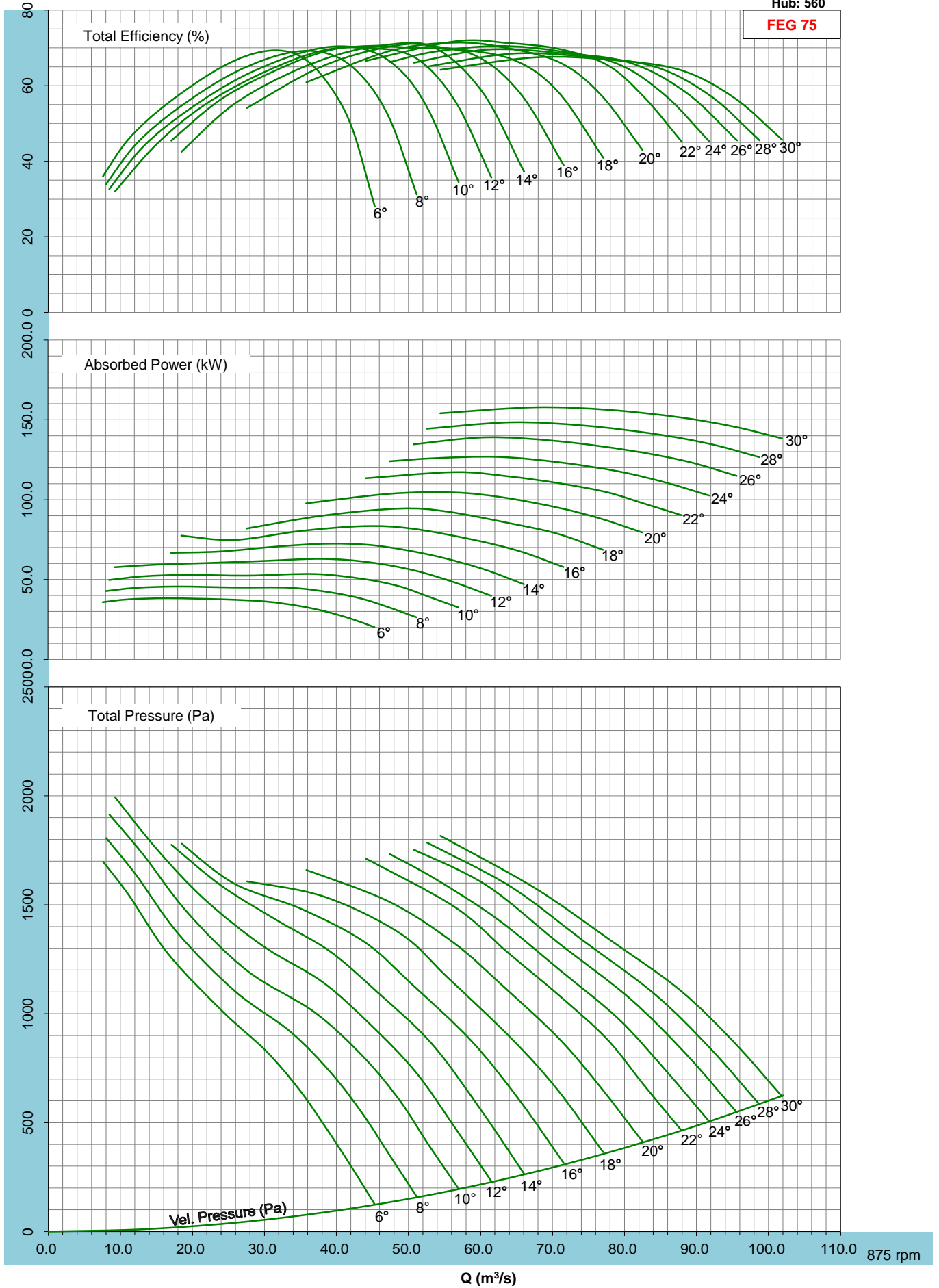

- Performance certified is for installation type D - ducted inlet, ducted outlet. Performance ratings do not include the effects of appurtenances (accessories).

NOTES

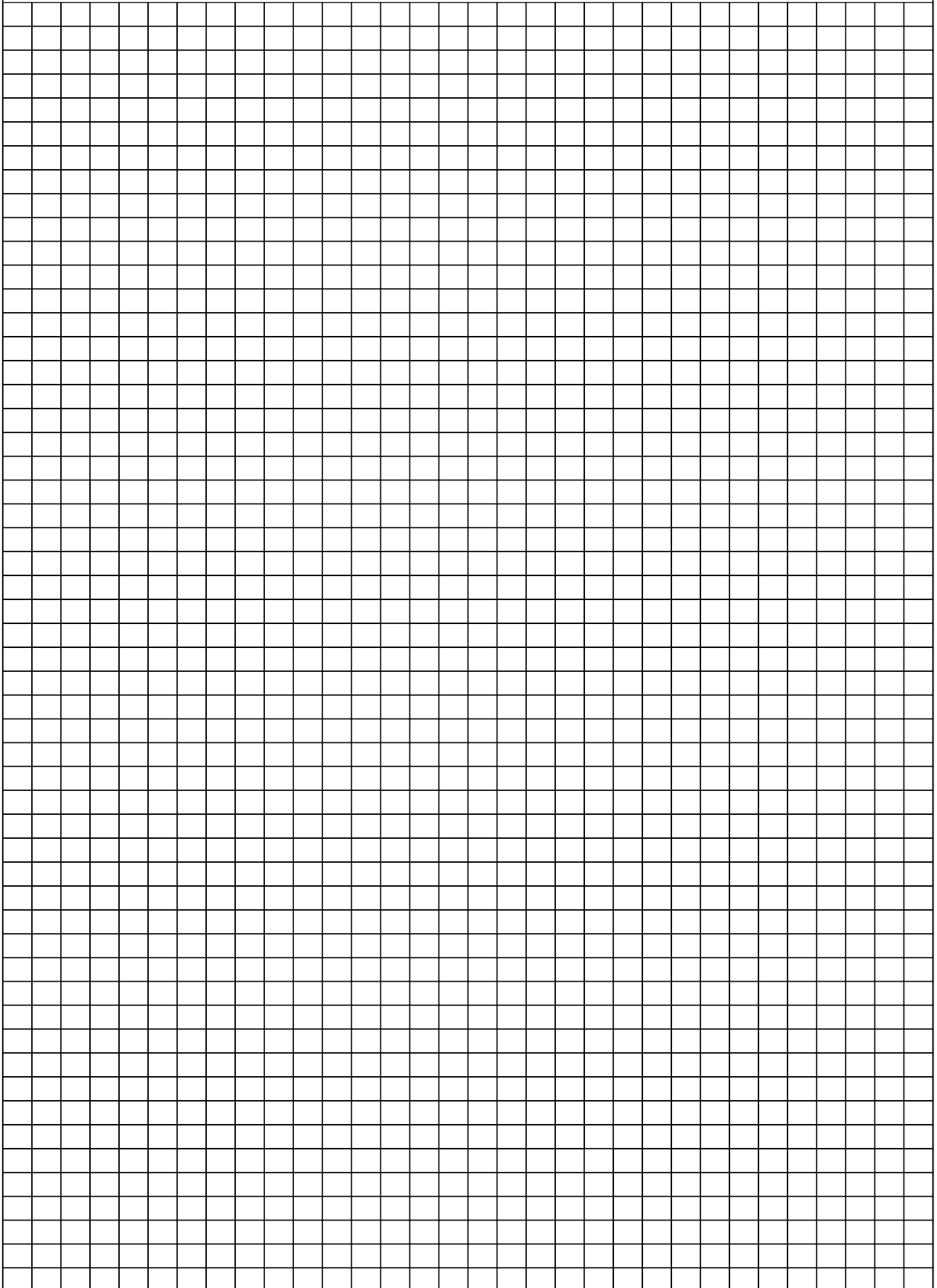

KRUGER GROUP (VENTILATION)

• THAILAND (Regional HQ)

KRUGER VENTILATION INDUSTRIES ASIA CO. LTD.
30/159 Moo 1, Sinsakorn Industrial Estate,
Chetsadawithi Road, Khok Kham Mueng, Samuthsakorn 74000, Thailand
Tel. +662 1054289 - Fax +662 1050373
Website: www.krugerfan.com

• CHINA (BEIJING)

BEIJING KRUGER VENTILATION CO. LTD
Level 7, A Block, Rising International Building, 29 JingHai San Road, BDA,
Beijing, P.R.China 100176
Tel. +86 10-67881366 - Fax +86 10-67880566
Email: krugertj@krugertj.com

• CHINA (SHANGHAI)

SHANGHAI KRUGER VENTILATION CO. LTD
No. 500 Yuanguo Road, Anting, Jiading,
Shanghai 201814 P.R. China
Tel. +86 21-69573266 - Fax +86 21-69573296
Email: shkruger@krugerchina.com

• CHINA (WUHAN)

WUHAN KRUGER VENTILATION CO. LTD
No. 805, Huian Ave, Dongxihu District, Wuhan, Hubei, P.R. China 430000
Tel. +86 27- 83248840/83060522/83097505
Fax +86 27- 83261886
Email: whkruger@krugerwh.com

• HONG KONG

KRUGER VENTILATION (HONG KONG) LIMITED
Flat C, 9/F, Yeung Yiu Chung (No.8) Industrial Building,
20 Wang Hoi Road, Kowloon Bay, Kowloon, Hong Kong
Tel. +852 22469182 - Fax +852 22469187
Email: info@kruger.com.hk

• INDIA (NORTH)

KRUGER VENTILATION INDUSTRIES (NORTH INDIA) PVT LTD
Plot No. - 191, Sector - 59, Ballabgarh, Faridabad - 121 004, Haryana, India
Tel. +91-9958991660/9717449696
Fax. +91-1294135820
Email: sales.kni@krugerindia.com

• KOREA

NEOMATE CO. LTD
2-1010, Ace High Tech City B/D, 775 Gyeongin-ro,
Yeongdeungpo-gu, Seoul, Korea. Postal Code 07299
Tel. +82-2-2679-2052 - Fax. +82-2-2679-2174
Email: y7890@neomate.co.kr

• MYANMAR

KRUGER VENTILATION (MYANMAR) CO.LTD
Room No. F21, Thiri Yadanar Whole Sale Market, (Htawunbe)
Toe Chae Ward, North Okkalapa Township, Yangon.
Tel. +959 763141081/2/3
Email: htoon@krugermm.com

• SINGAPORE (KEN)

KRUGER ENGINEERING PTE LTD
No. 10 Buroh Street #06-06, West Connect Building,
Singapore 627564
Tel. +65 68631191 - Fax +65 68631151
Email: mktg@krugerasia.com

• THAILAND (KVT)

KRUGER VENTILATION IND. (THAILAND) CO. LTD
30/105 Moo 1, Sinsakorn Industrial Estate,
Chetsadawithi Road, Khok Kham Mueng, Samuthsakorn 74000, Thailand
Tel. +662 1050399 - Fax + 662 1050370-2
Email: mktg@kruger.co.th

• AUSTRALIA

S&P-KRUGER AUSTRALIA PTY LTD
2 Cunningham St, Moorebank N.S.W. 2170
Tel. +61 2-98227747
Fax. +61 2-98227757
Email: info@sandpkruger.com.au

• CHINA (GUANGZHOU)

GUANGZHOU KRUGER VENTILATION CO. LTD
No. 9 Huahui Road, Huashan, Huadu,
Guangzhou, P.R. China 510880
Tel. +86 20-66356635 - Fax +86 20-86786001/86786500
Email: gzkruiger@krugergz.com

• CHINA (TIANJIN)

TIANJIN KRUGER VENTILATION CO. LTD
No.168 Anyuan Road, Jingjin Science and Technology Park
Wuqing District, Tianjin, China
Tel. +86 22-22143480/3481 - Fax +86 22-22143482
Email: krugertj@krugertj.com

• DUBAI

KRUGER VENTILATION INDUSTRIES, GULF BRANCH
Jebel Ali Free Zone Area (JAFZA) P.O. Box No. 262949, Dubai, UAE
Tel. +971 4 8819188/8832017
Fax. +971 4 8832018
Email: johncs@krugerasia.com

• INDIA

KRUGER VENTILATION INDUSTRIES (INDIA) PVT LTD
Kruger Centre, Mumbai-Nasik Highway,
Kalamgaon, Shahapur, Thane 421601, Maharashtra, India
Tel. +91 9960558899/9975577211 - Fax +91 2527 240075
Email: sales@krugerindia.com

• INDONESIA

P.T. KRUGER VENTILATION INDONESIA
JL. Teuku Umar No.20,
Karawaci - Tangerang 15115, Indonesia
Tel. +62 21-5512288/5513557 - Fax +62 21-5513502
Email: mktg@krugerindo.co.id

• MALAYSIA

KRUVENT INDUSTRIES (M) SDN BHD
Lot 850, Jalan Subang 7, Taman Perindustrian Subang,
47500, Subang Jaya, Selangor D.E.
Tel. +603 80743399 - Fax +603 80743388
Email: mktg@kruger.com.my

• PHILIPPINES

KRUGER M&E INDUSTRIES CORPORATION
FAPI Compound, E. Rodriguez Ave.
Tunasan, Muntinlupa City 1773, Philippines
Tel. +63 2-8622892/4/6/7, 5534059 - Fax +63 2-8622891
Email: mktg@krugerph.net

• TAIPEI

KRUGER VENTILATION (TAIWAN) CO. LTD
No. 157, Ping-an Rd, Hengfeng Village,
Dayuan Shiang Taoyuan County 337, Taiwan
Tel. +886 3-3859119 - Fax +886 3-3859118
Email: sales@krugertwn.com.tw

• VIETNAM

KRUGER VENTILATION INDUSTRIES (VIETNAM) CO. LTD
Lot A7. 2-4, C2 Road, Thanh Thanh Cong IZ,
Trang Bang Dist. Tay Ninh Province, Vietnam
Tel. +84-276 3585200/01/02 - Fax +84-276 3585199
Email: mktg@krugervn.com

The company is always improving and developing its products, therefore the company reserves the right of making changes to the illustrated products. Certified dimension can be provided upon request.