

Application

The TICD-51BF and TICD-52BF control dampers employ thermally insulated and broken aluminum airfoil blades and a thermally broken rugged channel frame to eliminate the transfer of heat or cold penetration and reduce condensation. The TICD-51BF and TICD-52BF dampers are designed for extremely cold temperatures and provide extreme low leakage as well as exceptional air control in medium to high pressure and velocity applications. Both models comply with the IECC (International Energy Conservation Code) with a leakage rating of 3 cfm/ft²@ 1 in. wg. (0.015 m³/s/m² @ 0.25 kPa) or less.

Standard Construction

Frame: 4" x 1" x 0.081" (102 x 25 x 2) top/bottom and 4" x 1-1/8" x 0.081" (102 x 29 x 2) jambs, thermally broken extruded aluminum channel.

Blades: 6" (152) heavy gauge, dual wall thermally insulated and broken extruded aluminum - airfoil. Parallel (TICD-51BF) or opposed (TICD-52BF) action.

Axes: 1/2" (13) diameter plated steel hex.

Linkage: Concealed in frame.

Bearings: Synthetic.

Seals: Silicone - blade edge and jambs. Both are mechanically fastened.

Control Shaft: 1/2" x 6" (13 x 152) round drive axle with outboard shaft support bracket and bearing supplied for field installation. Factory installed 3/4" (19) diameter jackshaft on all multiple section dampers more than 2 sections wide.

Minimum Size: TICD-51BF (one blade): 6" x 6.5" (152 x 165)
TICD-51BF and TICD-52BF (two blades):
6" x 12" (152 x 305)

Maximum Size: Single section: 60" x 72" (1524 x 1829)
Multiple sections: Unlimited

Options

- Factory installed external mount actuator:
 - Manual locking quadrant (supplied loose)
 - 24 VAC 120 VAC 230 VAC
 - Pneumatic Modulating
 - External mount (requires sleeve or sideplate option)
 - Internal mount (requires jackshaftering)
- Factory installed sleeve. Factory installed sideplate.
Gauge: 20 (1.0) 16 (1.5)
Length: 16" (406) 24" (610) Other ____
- Transitions (sleeve required): Flanged
 Round Oval
 Duct connections: DM-25 DM-35 S & Drive
- Extended perimeter mounting flange.
- Jackshaftering (required with internal mounted actuators and standard on all multiple section dampers).

Ratings

Damper Width	Maximum System Pressure	Maximum System Velocity
12" (305)	11.8 in. wg (3.0 kPa)	4000 fpm (20.3 m/s)
24" (610)	9.7 in. wg (2.4 kPa)	4000 fpm (20.3 m/s)
36" (914)	7.5 in. wg (1.9 kPa)	4000 fpm (20.3 m/s)
48" (1219)	5.3 in. wg (1.3 kPa)	4000 fpm (20.3 m/s)
60" (1524)	3 in. wg (0.75 kPa)	4000 fpm (20.3 m/s)

Temperature: -70° to 212°F (-57°C to 100°C)

AMCA Certified Air Leakage

Maximum Damper Width	*Leakage Class			
	@ 1" in. wg (0.25 kPa)	@ 4" in. wg (1.0 kPa)	@ 8" in. wg (2.0 kPa)	@ 10" in. wg (2.5 kPa)
60" (1524)	1A	1	1	1

* Leakage Class Definitions:

Leakage Class 1A - 3 cfm/ft² @ 1 in. wg (0.015 m³/s/m² @ 0.25 kPa)

Leakage Class 1 - 4 cfm/ft² @ 1 in. wg (0.020 m³/s/m² @ 0.25 kPa)

8 cfm/ft² @ 4 in. wg (0.41 m³/s/m² @ 1.0 kPa)

11 cfm/ft² @ 8 in. wg (0.056 m³/s/m² @ 2.0 kPa)

12.6 cfm/ft² @ 10 in. wg (0.064 m³/s/m² @ 2.5 kPa)

AMCA Certified Thermal Efficiency Ratio:

TICD-51BF: 477%

TICD-52BF: 425%

Test Information - Efficiency performance in accordance with ANSI/AMCA Standard 500-D, Figure 5.10 with a 36" x 36" sample. Data are based upon a torque of 9.0 in-lb/ft² (0.56 N-m) applied to close and seat the damper during the test.

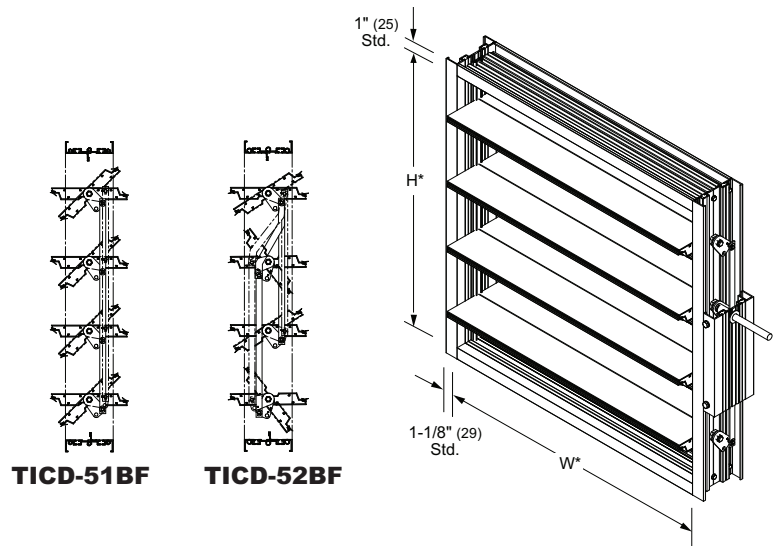

Model **TICD-51BF**
(standard)

*Damper dimensions furnished approximately net I.D.

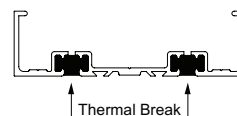

Frame

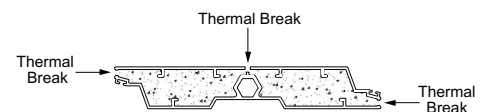

Airfoil Blade

Certified Ratings:

Pottorff certifies that the models TICD-51BF and TICD-52BF shown herein are licensed to bear the AMCA seal. The ratings shown are based on test and procedures performed in accordance with AMCA Publication 511 and comply with the requirements of the AMCA Certified Ratings Program. The AMCA Certified Ratings seal applies to Air Performance, Air Leakage and Energy Efficiency Ratings.



Leakage Results At Temperature and Thermal Performance

Leakage At Temperature @ 1.2 in. wg. (36" x 36" test sample)

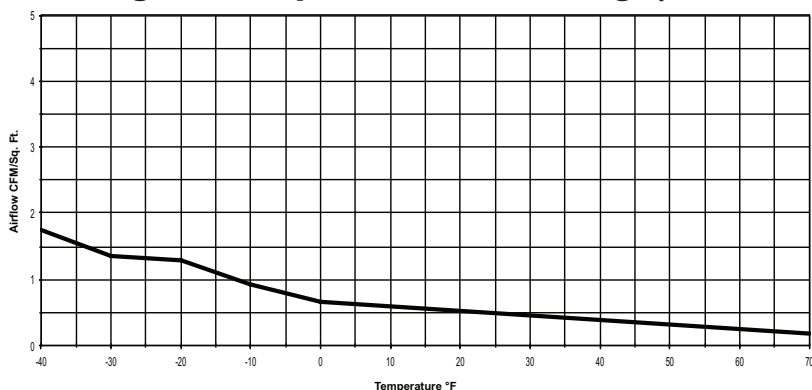

Thermal Performance

Testing was conducted per NFRC 102 on a 36" x 36" test sample. The Damper Thermal Resistance (R Value) is 1.67.

Airflow Performance Data

Pressure Loss vs. Velocity

Figure 5.3 — Ducted Inlet and Outlet

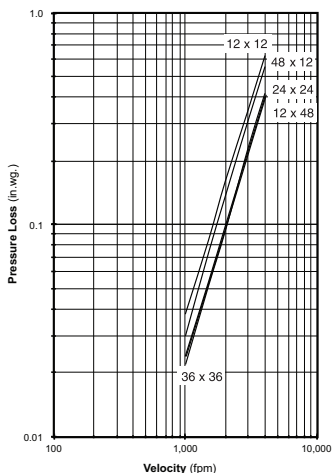

Figure 5.2 — Ducted Inlet

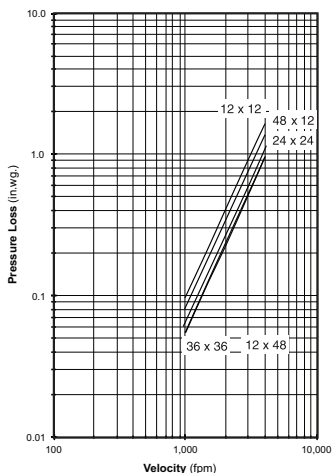
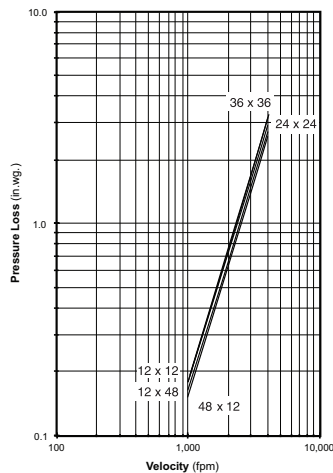

Figure 5.5 Plenum Mount



Certified Ratings:

Pottorff certifies that the models TICD-51BF and TICD-52BF shown herein are licensed to bear the AMCA seal. The ratings shown are based on test and procedures performed in accordance with AMCA Publication 511 and comply with the requirements of the AMCA Certified Ratings Program. The AMCA Certified Ratings seal applies to Air Performance, Air Leakage and Energy Efficiency Ratings.

Pressure drop testing was performed in accordance with AMCA Standard 500-D using the three configurations shown. All data has been corrected to represent air density of 0.075 lb/ft. Actual pressure drop in any ducted HVAC system is a combination of many elements. This information, along with analysis of other system influences, should be used to estimate actual pressure losses for a damper installed in a given HVAC system.



Ducted Inlet and Outlet

AMCA Figure 5.3 illustrates a fully ducted damper. This configuration represents the lowest pressure drop of the three test configurations because entrance and exit losses are minimized by straight duct runs upstream and downstream of the damper.

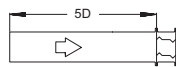

Ducted Inlet

AMCA Figure 5.2 illustrates a ducted damper exhausting air into an open area. This configuration has a lower pressure drop than Figure 5.5 because entrance losses are minimized by a straight duct run upstream of the damper.



Plenum Mount

AMCA Figure 5.5 illustrates a plenum mounted damper. This configuration has the highest pressure drop because of extremely high entrance and exit losses due to the sudden changes of area in the system.

Installation

1. Dampers must be installed square and free from racking.
2. Dampers are designed to be self-supporting in the maximum single section size. When dampers are installed in multiple section assemblies, bracing may be required to support the weight of the dampers and to ensure structural integrity against system pressures. It is recommended that multiple sections be appropriately braced. In horizontal installations, it is recommended that suitable supports be installed every 8 feet of damper width. Dampers installed in vertical multiple assemblies and/or higher system pressures, may require additional bracing.
4. See Model TICD Installation Instructions for further installation details.

Information is subject to change without notice or obligation.

NOTE: Dimensions in parentheses () are millimeters.