



MTD Silent Series

IN-LINE MIXED FLOW DUCT FAN



In-line Mixed Flow Duct Fan – MTD Silent Series

KRUGER



MTD Silent 100/2~200/2



MTD Silent 250~315



Kruger Ventilation Industries (India) Pvt. Ltd. certifies that the **MTD Silent series** shown herein is licensed to bear the AMCA Seal. The ratings shown are based on tests and procedures performed in accordance with AMCA Publication 211 and AMCA Publication 311 and comply with the requirements of the AMCA Certified Ratings Program.

- * Low profile Mixed Flow fans with sound-absorbent insulation Extremely quiet.
- * The low profile of the MTD Silent fans makes the most effective solution for installations where space is limited such as in ceiling voids.

MTD Silent 100/2~200/2

General

- Manufactured in plastic material, with a specifically designed internal skin to direct the sound waves in the right angle for them to be captured by the sound-absorbent material
- Fitted with rubber gaskets on the inlet and outlet to absorb vibrations, a body that can be dismantled.
- Connection box can be rotated 360°, to facilitate easy connection of the power cable.
- The low profile of the MTD Silent fans makes them the most effective solution for installations where the space of installation is limited such as false ceilings.

Motors

- Speed controllable 230V -50Hz motor, of two speed motors. IP 44.
- Motors are Class B, with ball bearings and safety thermal overload protection.

MTD Silent 250~315

General

- Constructed from sheet steel with epoxy polyester paint, acoustic insulation(MO) glass fibre, within outer shell.
- Aerodynamic inlet to improve air flow and reduce sound. Detachable fan unit without demounting duct connections.

Motors

- IP 44. External terminal box IP 55.
- Removable fan body with two speed motor, single phase 230V-50/60 Hz speed controllable, Class F, external rotor aluminium motor with capacitor and thermal protection.

Additional information

- The models offer solutions to ventilation problems, especially in places where people work and low sound level is required.

Technical Data

Model	Maximum Flowrate (m ³ /h)	Maximum Input Power (W)	Maximum Current (A)	Motor	Voltage (V)	Hz	Speed (rpm)	Min-Max Air Temperature (°C)	Lp(A) at 3m free discharge (dB(A))*	Weight (kg)
MTD Silent 100/2	228 / 185	25 / 18	0.18 / 0.12	Single Phase	230	50	2260 / 1900	-20 / +40	43 / 39	5.4
	234 / 185	32 / 21	0.13 / 0.10			60	2370 / 1950		41 / 36	
MTD Silent 125	341 / 279	31 / 23	0.13 / 0.10	Single Phase	230	50	2280 / 1960	-20 / +40	40 / 35	5.0
	357 / 285	38 / 25	0.10 / 0.10			60	2460 / 2050		41 / 36	
MTD Silent 160	564 / 450	55 / 43	0.24 / 0.18	Single Phase	230	50	2600 / 2180	-20 / +60	48 / 48	6.0
	623 / 396	71 / 50	0.25 / 0.21			60	2890 / 2050		50 / 42	
MTD Silent 200/1	899 / 773	100 / 93	0.50 / 0.40	Single Phase	230	50	2380 / 2180	-20 / +60	49 / 52	8.7
	895 / 698	125 / 104	0.50 / 0.35			60	2510 / 2160		52 / 46	
MTD Silent 200/2	1018 / 809	130 / 129	0.56 / 0.53	Single Phase	230	50	2580 / 2260	-20 / +60	50 / 45	8.7
	1060	168	0.61			60	2830		50	
MTD Silent 250	1271 / 1089	185 / 136	0.57 / 0.52	Single Phase	230	50	2610 / 2310	-20 / +60	50 / 45	20.0
	1364 / 1011	246 / 156	0.98 / 0.63			60	2860 / 2310		55 / 45	
MTD Silent 315	1726 / 1413	283 / 176	1.01 / 0.65	Single Phase	230	50	2480 / 1910	-40 / +60	53 / 47	25.0
	1877 / 1328	362 / 192	1.40 / 0.77			60	2590 / 1760		52 / 46	

* Inlet Lp(A) sound pressure levels at 3m are measured at free discharge in spherical free field condition, inlet Lp(A) (dB(A)) levels are not licensed by AMCA International.

- Performance ratings do not include the effects appurtenances (accessories).

- Performance certified is for installation type D - Ducted inlet, Ducted outlet.

- Speed (RPM) shown is nominal. Performance is based on actual speed of test.

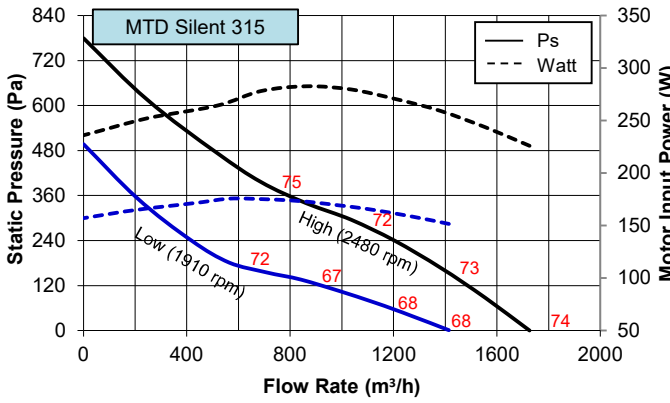
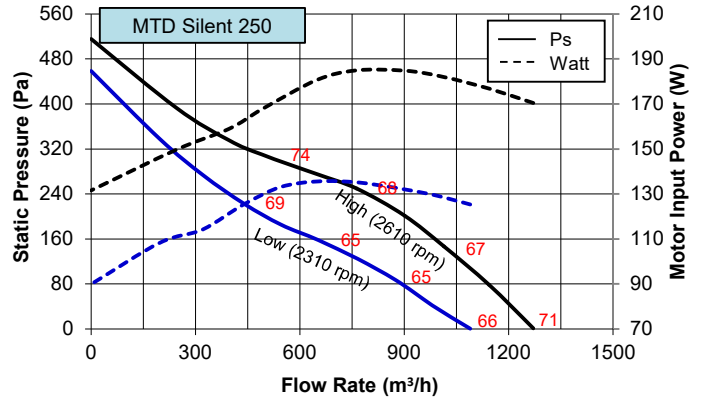
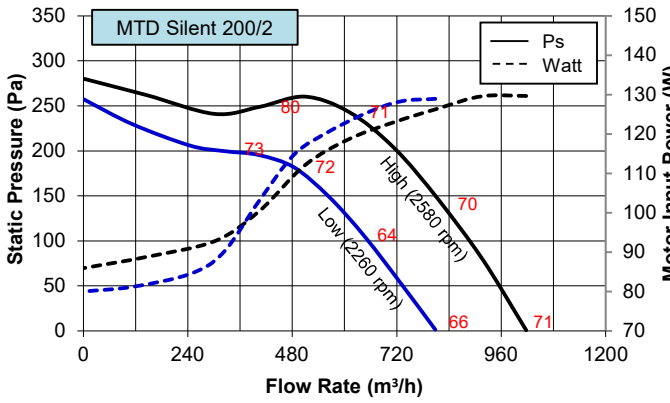
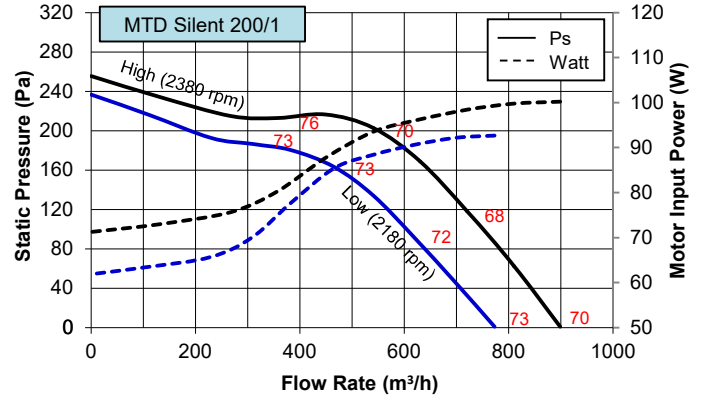
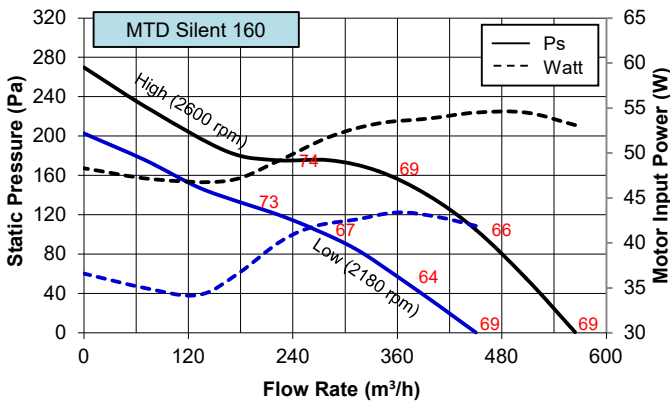
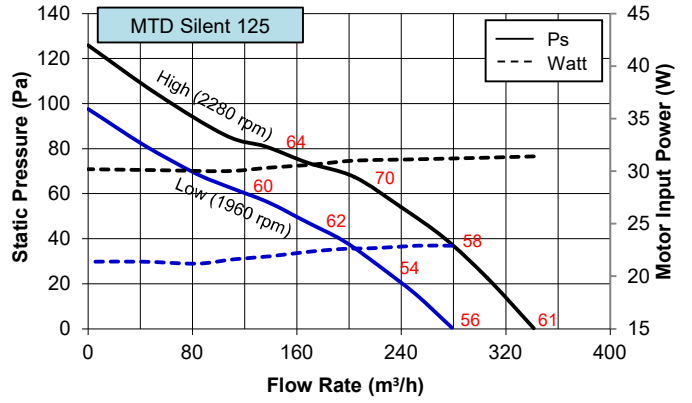
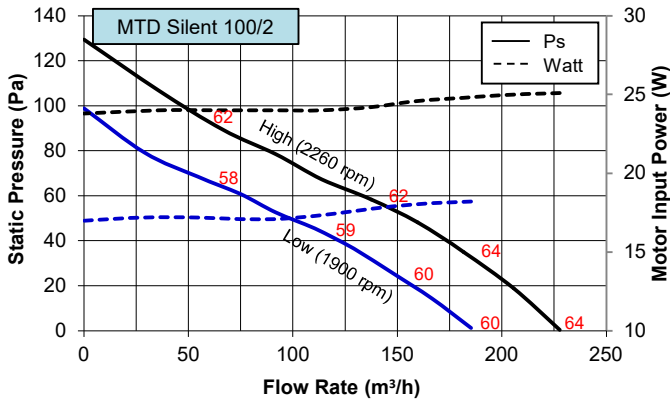

- Values shown are for inlet Lwi(A) sound power levels for installation type D: Ducted inlet, Ducted outlet. The A-weighted sound ratings shown have been calculated per AMCA International Standard 301.
- Performance certified is for installation type D – Ducted inlet, Ducted outlet.
- Performance ratings do not include the effects of appurtenances (accessories).
- Speed (RPM) shown is nominal. Performance is based on actual Speed of test.

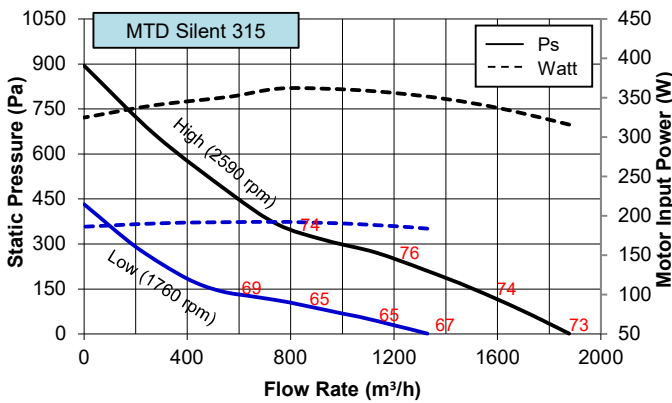
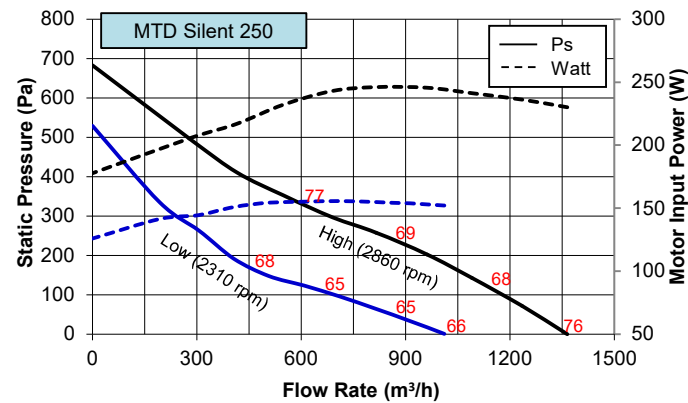
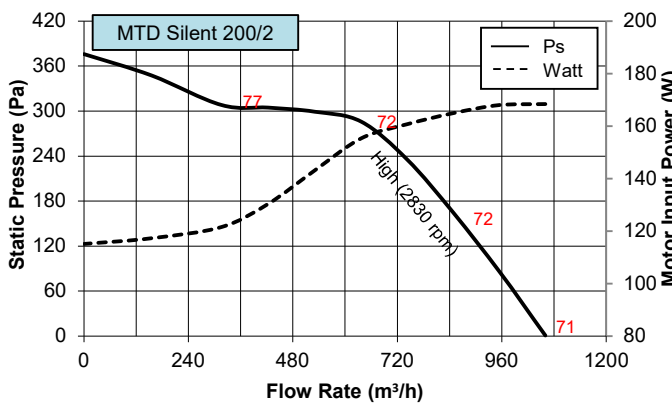
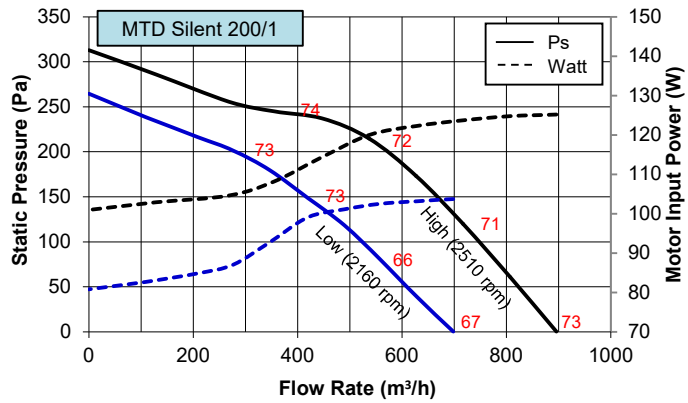
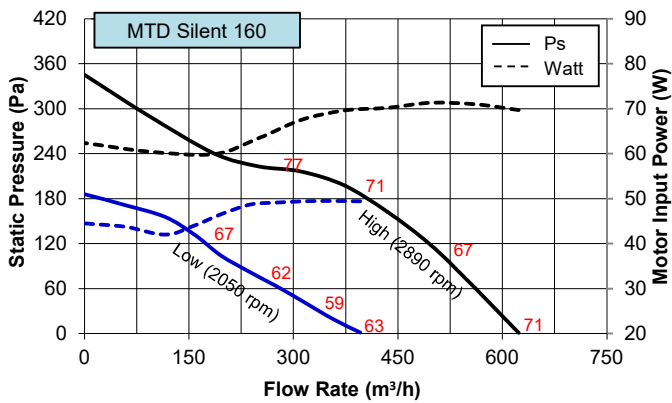
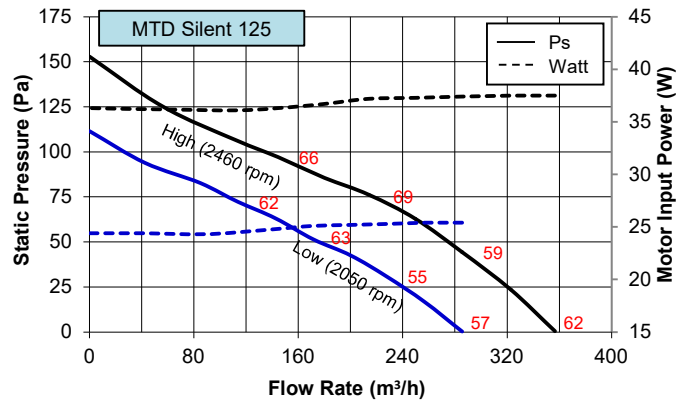
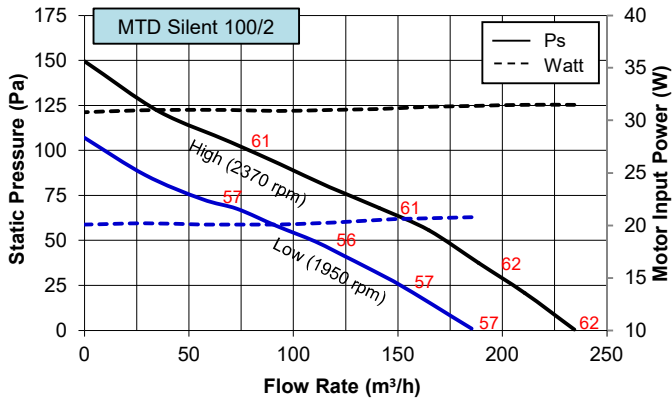

- Values shown are for inlet Lwi(A) sound power levels for installation type D: Ducted inlet, Ducted outlet. The A-weighted sound ratings shown have been calculated per AMCA International Standard 301.
- Performance certified is for installation type D – Ducted inlet, Ducted outlet.
- Performance ratings do not include the effects of appurtenances (accessories).
- Speed (RPM) shown is nominal. Performance is based on actual Speed of test.

Dimension

MTD Silent 100/2 ~ 200/2

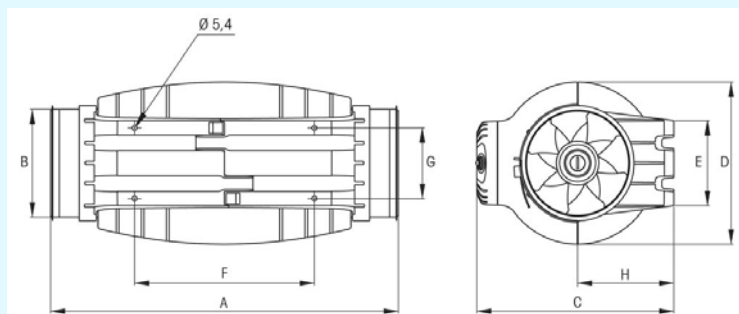

Model	A	ØB	C	ØD	E	F	G	H
MTD Silent 100/2	575	97	252	204	100	250	83	121
MTD Silent 125	462	123	252	204	100	250	83	121
MTD Silent 160	484	147	274	221	116	250	96	134
MTD Silent 200/1	568	198	327	264	145	340	129	164
MTD Silent 200/2	568	198	327	264	145	340	129	164

MTD Silent 250 ~ 315

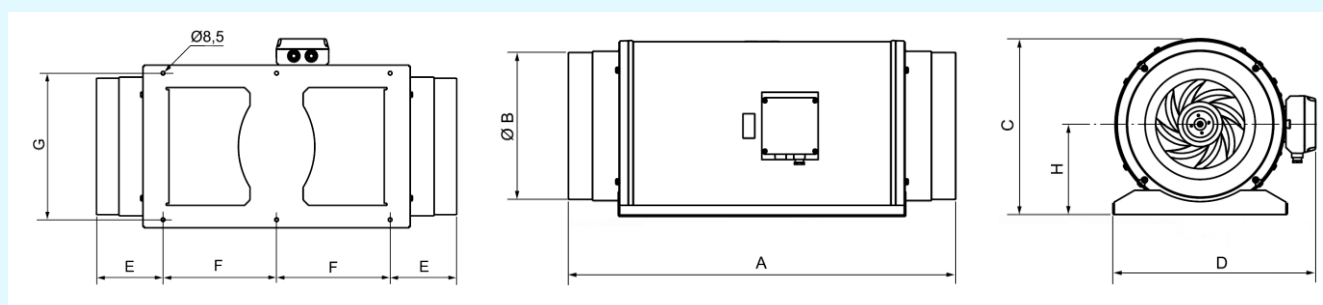

Model	A	B	C	D	E	F	G	H
MTD Silent 250	680	248	331	387	140	200	280	171
MTD Silent 315	825	312	373	432	152	260	335	192

All dimension in mm.

Accessories



MCA-S

Non-return flaps to be installed at the fan discharge. They prevent heat leakages when the extractor is not operating.



MAR-S

Rectangular Duct Adapters enable connection to rectangular ducting.



MRJ-S

Grilles mounted at the inlet or outlet of the fan, to prevent the entry of any foreign objects that could damage the fan.



MPC-S

Flow detectors designed to correctly measure pressures at the inlet with airflow straightner.



MBR-S

Flanges allowing the coupling of MTD-Silent fans in series.

KRUGER GROUP (VENTILATION)

• THAILAND (Regional HQ)

KRUGER VENTILATION INDUSTRIES ASIA CO. LTD.
30/159 Moo 1, Sinsakorn Industrial Estate,
Chetsadawithi Road, Khok Kham Mueng, Samuthsakorn 74000, Thailand
Tel. +662 1054298 - Fax +662 0248256-9
Website: www.krugerfan.com

• CHINA (BEIJING)

BEIJING KRUGER VENTILATION CO. LTD
Level 7, A Block, Rising International Building, 29 JingHai San Road, BDA,
Beijing, P.R.China 100176
Tel. +86 10-67881366 - Fax +86 10-67880566
Email: krugertj@krugertj.com

• CHINA (SHANGHAI)

SHANGHAI KRUGER VENTILATION CO. LTD
No. 500 Yuanguo Road, Anting, Jiading,
Shanghai 201814 P.R. China
Tel. +86 21-69573266 - Fax +86 21-69573296
Email: shkruger@krugerchina.com

• CHINA (WUHAN)

WUHAN KRUGER VENTILATION CO. LTD
No. 805, Huian Ave, Dongxihu District, Wuhan, Hubei, P.R. China 430000
Tel. +86 27- 83248840/83060522/83097505
Fax +86 27- 83261886
Email: whkruger@krugerwh.com

• HONG KONG

KRUGER VENTILATION (HONG KONG) LIMITED
Flat C, 9/F, Yeung Yiu Chung (No.8) Industrial Building,
20 Wang Hoi Road, Kowloon Bay, Kowloon, Hong Kong
Tel. +852 22469182 - Fax +852 22469187
Email: info@kruger.com.hk

• INDIA (NORTH)

KRUGER VENTILATION INDUSTRIES (NORTH INDIA) PVT LTD
Plot No. - 191, Sector - 59, Ballabgarh, Faridabad - 121 004, Haryana, India
Tel. +91-9958991660/9717449696
Fax. +91-1294135820
Email: sales.kni@krugerindia.com

• KOREA

NEOMATE CO. LTD
2-1010, Ace High Tech City B/D, 775 Gyeongin-ro,
Yeongdeungpo-gu, Seoul, Korea. Postal Code 07299
Tel. +82-2-2679-2052 - Fax. +82-2-2679-2174
Email: y7890@neomate.co.kr

• MYANMAR

KRUGER VENTILATION (MYANMAR) CO.LTD
Room No. F21, Thiri Yadanar Whole Sale Market, (Htawunbe)
Toe Chae Ward, North Okkalapa Township, Yangon.
Tel. +959 763141081/2/3
Email: htoon@krugermm.com

• SINGAPORE

KRUGER ENGINEERING PTE LTD
No. 10 Buroh Street #06-06, West Connect Building,
Singapore 627564
Tel. +65 68631191 - Fax +65 68631151
Email: mktg@krugerasia.com

• THAILAND

KRUGER VENTILATION IND. (THAILAND) CO. LTD
30/105 Moo 1, Sinsakorn Industrial Estate,
Chetsadawithi Road, Khok Kham Mueng, Samuthsakorn 74000, Thailand
Tel. +662 1050399 - Fax + 662 1050370-2
Email: mktg@kruger.co.th

• AUSTRALIA

S&P-KRUGER AUSTRALIA PTY LTD
2 Cunningham St, Moorebank N.S.W. 2170
Tel. +61 2-98227747
Fax. +61 2-98227757
Email: info@sandpkruger.com.au

• CHINA (GUANGZHOU)

GUANGZHOU KRUGER VENTILATION CO. LTD
No. 9 Huahui Road, Huashan, Huadu,
Guangzhou, P.R. China 510880
Tel. +86 20-66356635 - Fax +86 20-86786001/86786500
Email: gzkruger@krugerz.com

• CHINA (TIANJIN)

TIANJIN KRUGER VENTILATION CO. LTD
No.168 Anyuan Road, Jingjin Science and Technology Park
Wuqing District, Tianjin, China
Tel. +86 22-22143480/3481 - Fax +86 22-22143482
Email: krugertj@krugertj.com

• DUBAI

KRUGER VENTILATION INDUSTRIES, GULF BRANCH
Jebel Ali Free Zone Area (JAFZA) P.O. Box No. 262949, Dubai, UAE
Tel. +971 4 8819188/8832017
Fax. +971 4 8832018
Email: johncs@krugerasia.com

• INDIA

KRUGER VENTILATION INDUSTRIES (INDIA) PVT LTD
Kruger Centre, Mumbai-Nasik Highway,
Kalamgaon, Shahapur, Thane 421601, Maharashtra, India
Tel. +91 9960558899/9975577211 - Fax +91 2527 240075
Email: sales@krugerindia.com

• INDONESIA

P.T. KRUGER VENTILATION INDONESIA
Jl. Teuku Umar No.20,
Karawaci - Tangerang 15115, Indonesia
Tel. +62 21-5512288/5513557 - Fax +62 21-5513502
Email: mktg@krugerindo.co.id

• MALAYSIA

KRUVENT INDUSTRIES (M) SDN BHD
Lot 850, Jalan Subang 7, Taman Perindustrian Subang,
47500, Subang Jaya, Selangor D.E.
Tel. +603 80743399 - Fax +603 80743388
Email: mktg@kruger.com.my

• PHILIPPINES

KRUGER M&E INDUSTRIES CORPORATION
FAP I Compound, E. Rodriguez Ave.
Tunasan, Muntinlupa City 1773, Philippines
Tel. +63 2-8622892/4/6/7, 5534059 - Fax +63 2-8622891
Email: mktg@krugerph.net

• TAIPEI

KRUGER VENTILATION (TAIWAN) CO. LTD
No. 157, Ping-an Rd, Hengfeng Village,
Dayuan Shiang Taoyuan County 337, Taiwan
Tel. +886 3-3859119 - Fax +886 3-3859118
Email: sales@krugertwn.com.tw

• VIETNAM

KRUGER VENTILATION INDUSTRIES (VIETNAM) CO. LTD
Lot A7. 2-4, C2 Road, Thanh Thanh Cong IZ,
Trang Bang Dist. Tay Ninh Province, Vietnam
Tel. +84-276 3585200/01/02 - Fax +84-276 3585199
Email: mktg@krugervn.com

The company is always improving and developing its products, therefore the company reserves the right of making changes to the illustrated products. Certified dimension can be provided upon request.