

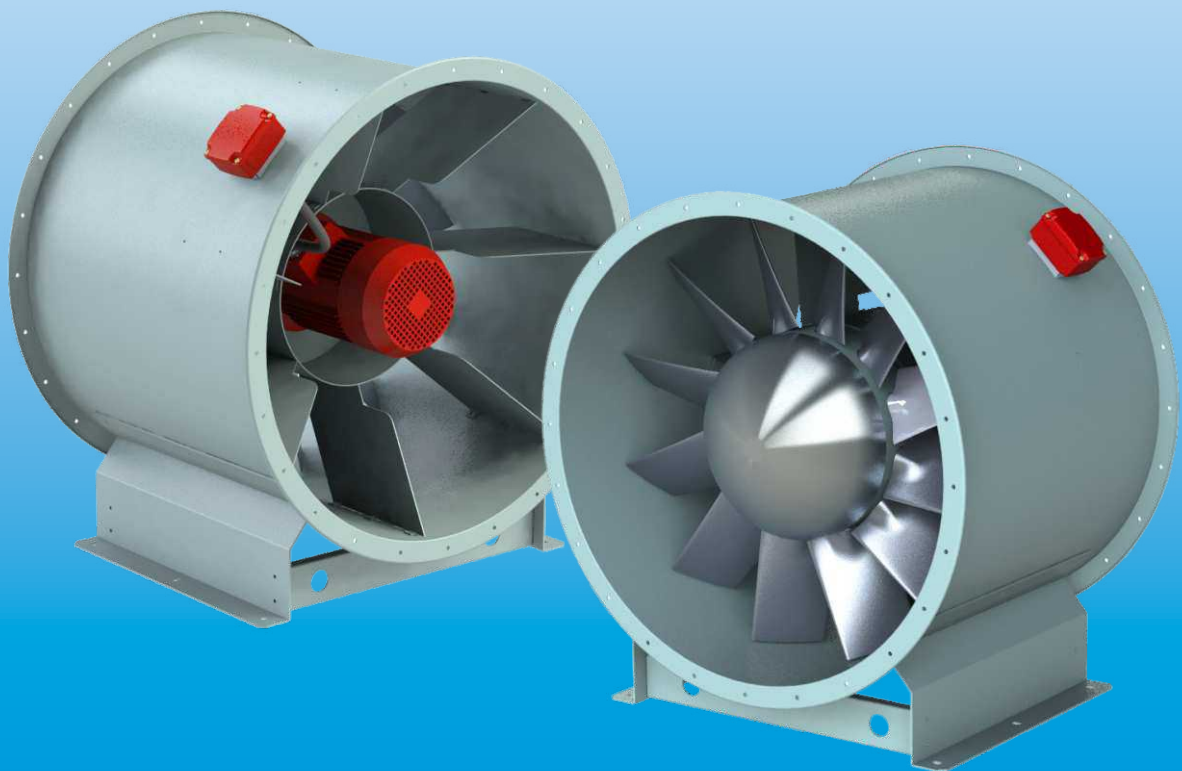

KTF Series

**DIRECT DRIVE REVERSIBLE
VANE AXIAL FAN**



Feature

For commercial and industrial application where large volume of air is required at moderate to high pressure in both directions (reversible flow) . Volume coefficient ranged from 0.2 to 0.8 and pressure coefficient ranged from 0.2 to 0.4.

Construction

Double flanged casing is produced in mild steel or galvanized steel. The reversible impeller blades are made of Aluminum Alloy.

Finish

Zinc rich primer and polyester powder coating or galvanized finishing are available for all mild steel parts.

Operating Temperature

Normal Ventilation: -20°C to +55°C
 High Temperature Application: available up to 400°C/2Hrs.

Motors

Totally Enclosed Class 'F' or 'H', with a min. IP55 protection are fitted as standard. Motors 3.0kW and above are star/delta starting. Motor of other specification are available upon request.

Truly Reversible

Reversibility of 95~100% air flow from impeller to motor is fitted as standard. Air flow from motor to impeller can be supplied upon request.



Kruvent Industries (M) Sdn. Bhd. certifies that the **KTF Series** shown herein is licensed to bear the AMCA Seal. The ratings shown are based on tests and procedures performed in accordance with AMCA Publication 211 and AMCA Publication 311 and comply with the requirements of the AMCA Certified Ratings Program.

Nomenclature

KTF 1250 / RB22 / H / 12-7V / 15° / N20

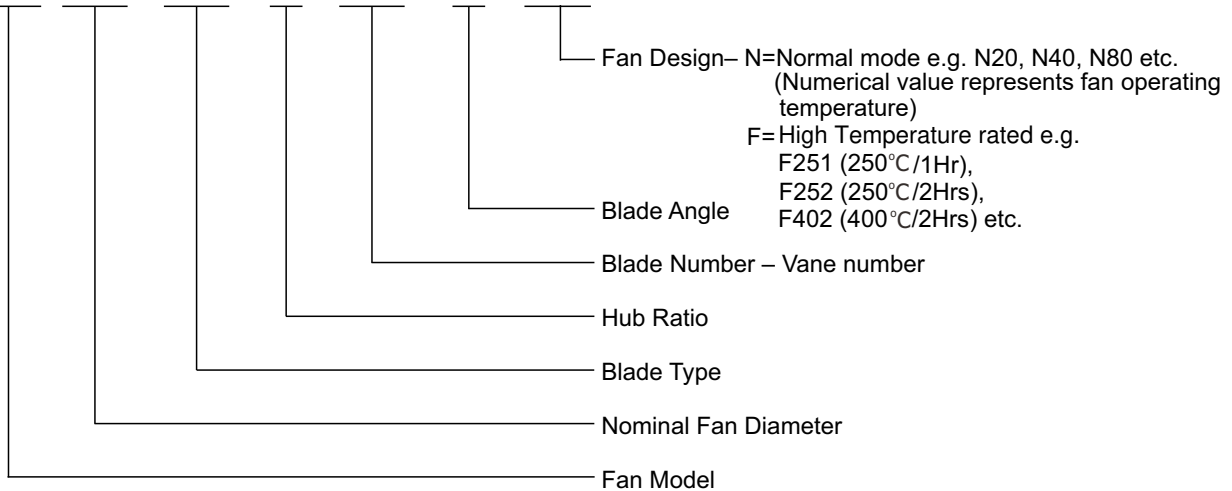

Dimension

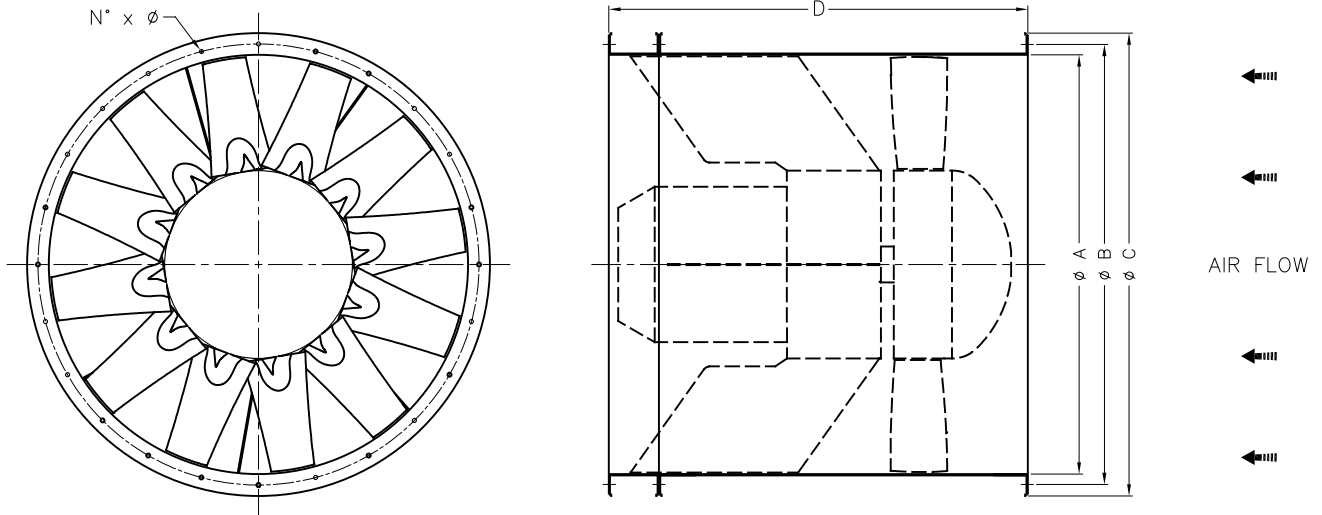

All dimension in mm.

Model	A	B	C	D	N°	Ø	Weight* (kg)	Max. Motor Frame Size**
1250	1250	1315	1380	1300	24	12	345	D250
1400	1400	1465	1530	1300	32	14	410	D280
1600	1600	1663	1730	1756	32	14	725	D315
1800	1800	1856	1930	2158	32	14	950	D355
2000	2000	2073	2130	2158	32	14	1160	D355
2240	2240	2330	2390	2200	38	18	1460	D355

* Weight without motor.

** Please consult KRUGER for motor frame size other than specified.

Example of Selection

Air Volume $Q = 11.68 \text{ m}^3/\text{s}$

Outlet Velocity $V_{out} = 9.52 \text{ m/s}$

Total Pressure $P_t = 323 \text{ Pa}$

Fan Speed $N = 950 \text{ rpm}$

Absorbed Power $H = 5.60 \text{ kW}$

Total Efficiency $\eta = 67.34 \%$

Sound Power Level $L_{wA} = 100 \text{ dB(A)}$

KTF1250 / RB22 / H / 12-7V (Forward) 950 rpm - 50 Hz

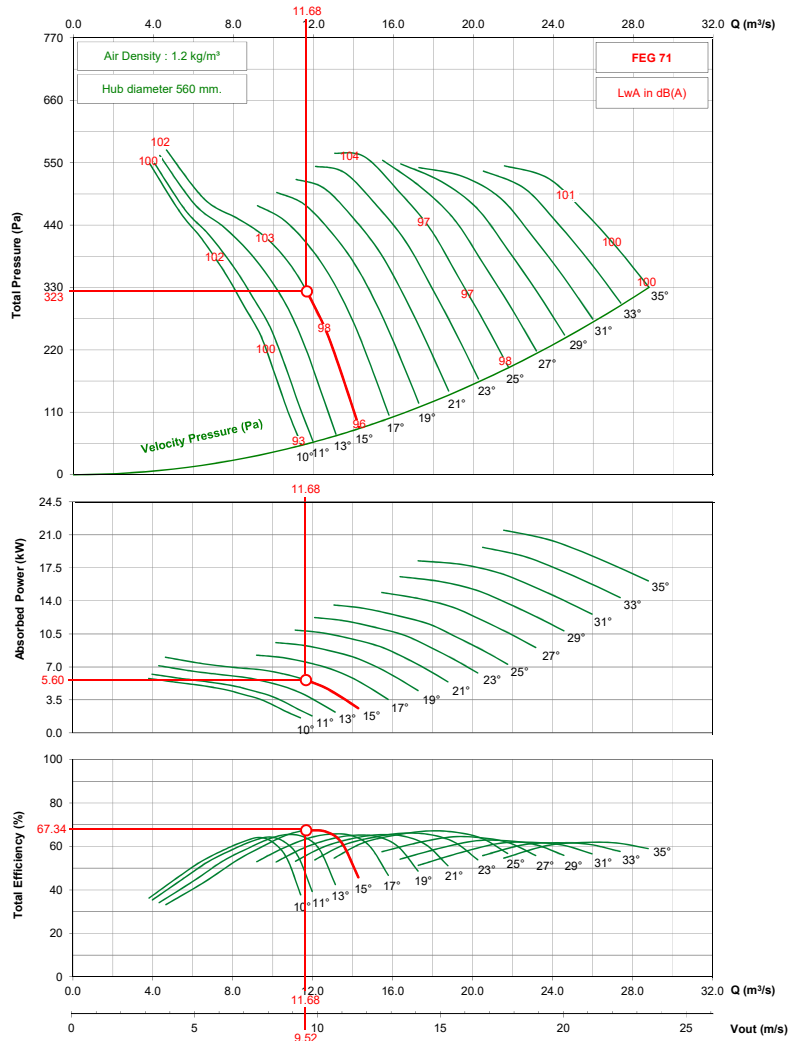

- Performance certified is for installation type D - ducted inlet, ducted outlet. Performance ratings do not include the effects of appurtenances (accessories).
 - The A-weighted sound ratings shown have been calculated per AMCA International Standard 301. Values shown are for inlet Lw(A) sound power levels for installation type D - ducted inlet, ducted outlet. Ratings include the effects of duct end correction.

KTF1250 / RB22 / H / 12-7V (Forward)

1450 rpm - 50 Hz

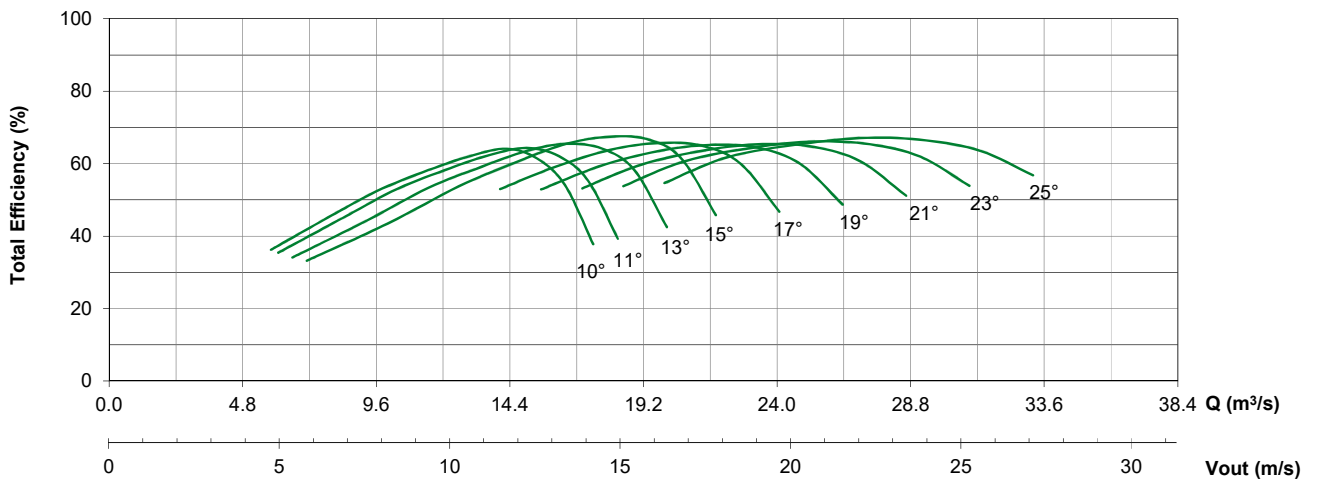
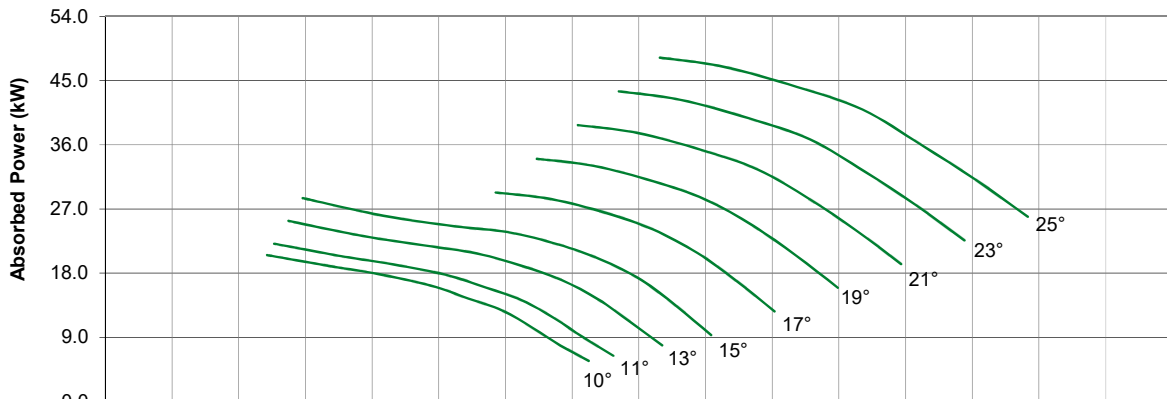
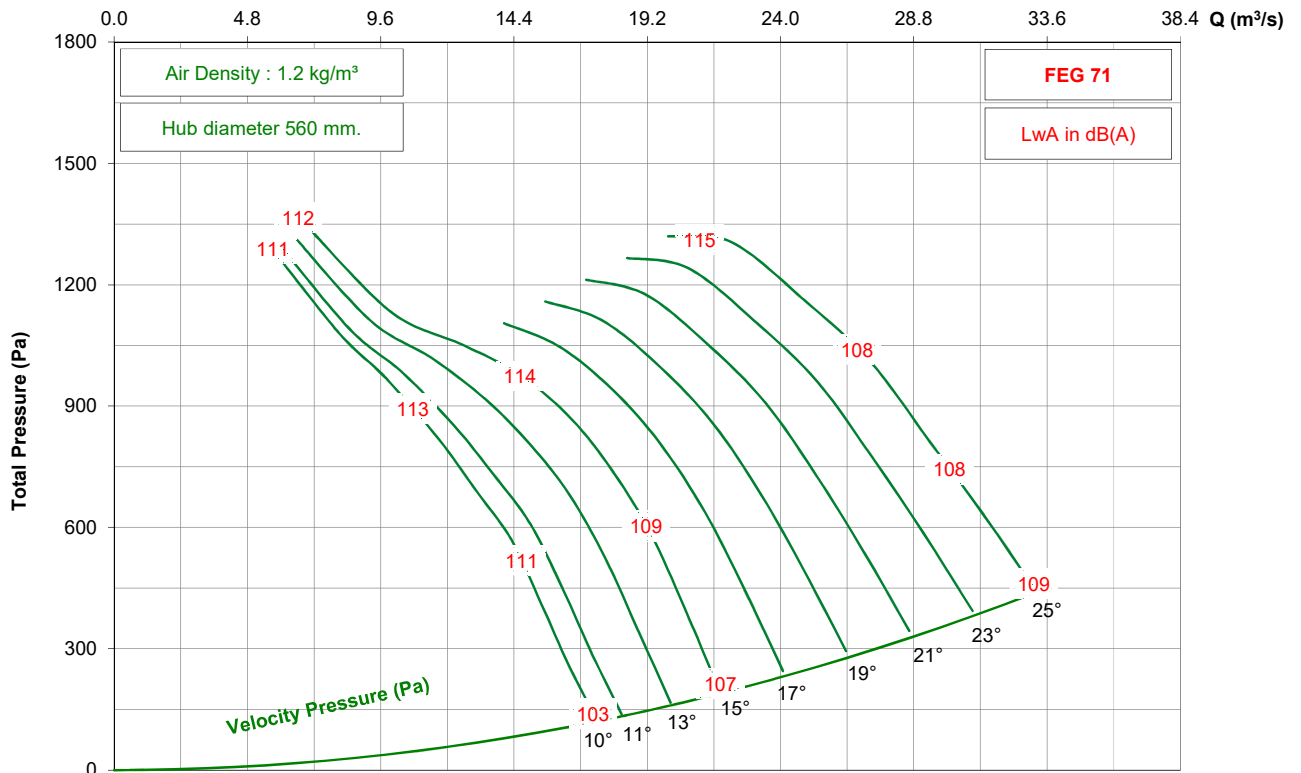

- Performance certified is for installation type D - ducted inlet, ducted outlet. Performance ratings do not include the effects of appurtenances (accessories).
 - The A-weighted sound ratings shown have been calculated per AMCA International Standard 301. Values shown are for inlet Lwi(A) sound power levels for installation type D - ducted inlet, ducted outlet. Ratings include the effects of duct end correction.

KTF1250 / RB22 / H / 12-7V (Forward)

950 rpm - 50 Hz

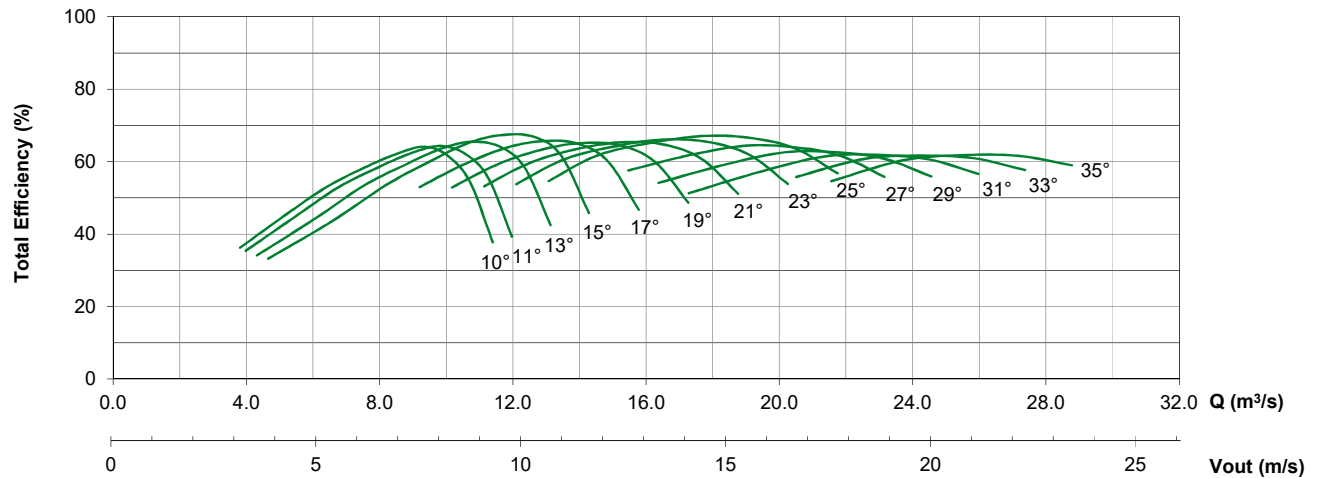
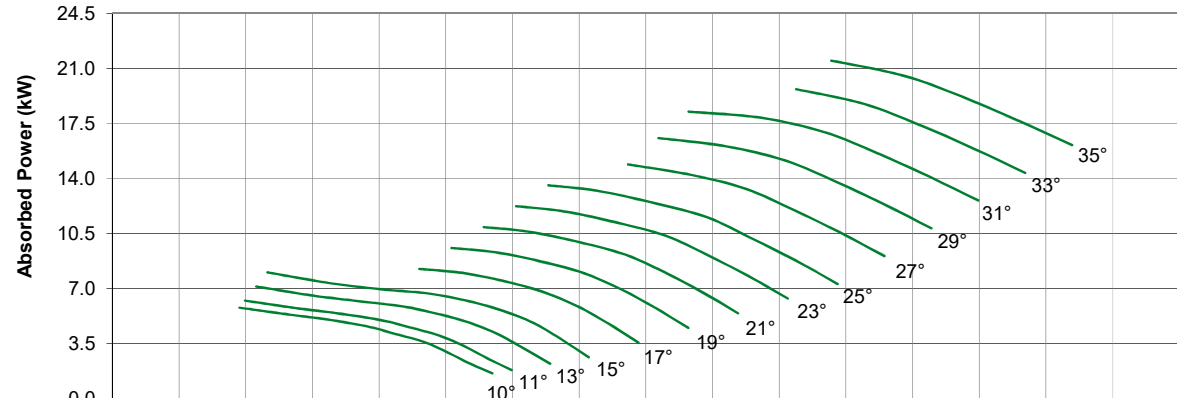
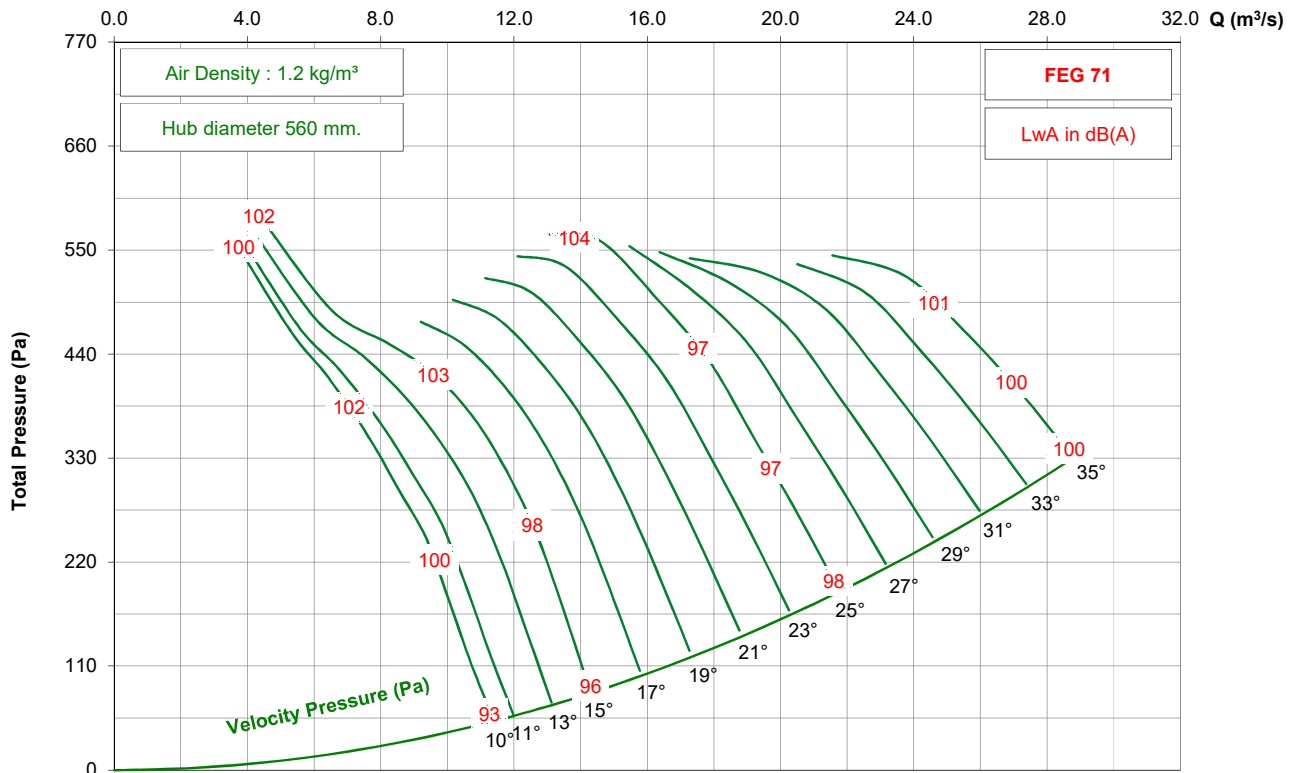

- Performance certified is for installation type D - ducted inlet, ducted outlet. Performance ratings do not include the effects of appurtenances (accessories).
 - The A-weighted sound ratings shown have been calculated per AMCA International Standard 301. Values shown are for inlet Lwi(A) sound power levels for installation type D - ducted inlet, ducted outlet. Ratings include the effects of duct end correction.

KTF1250 / RB22 / H / 12-7V (Forward)

725 rpm - 50 Hz

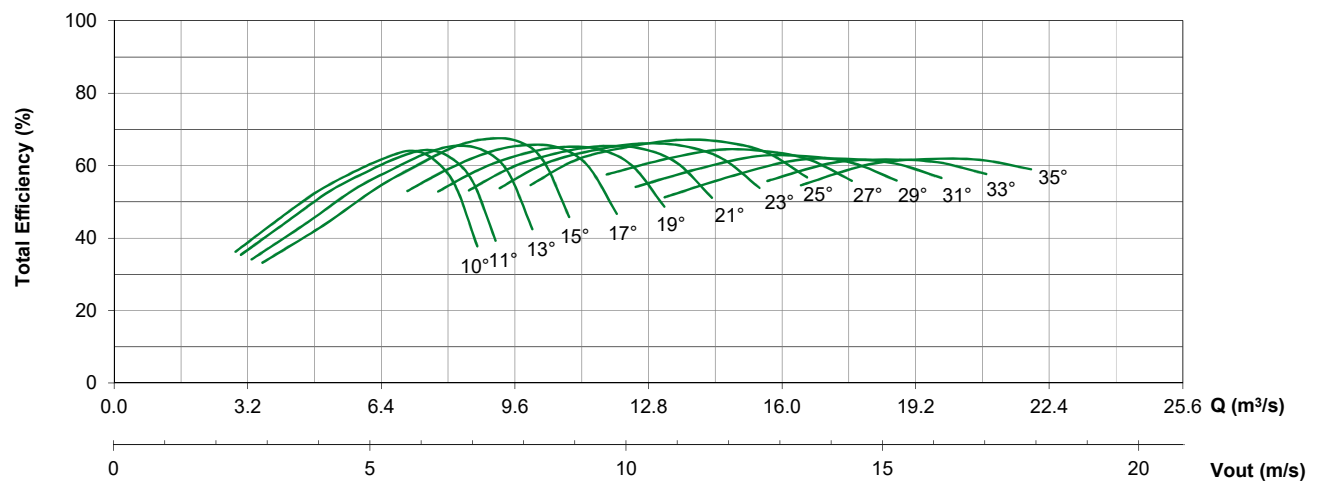
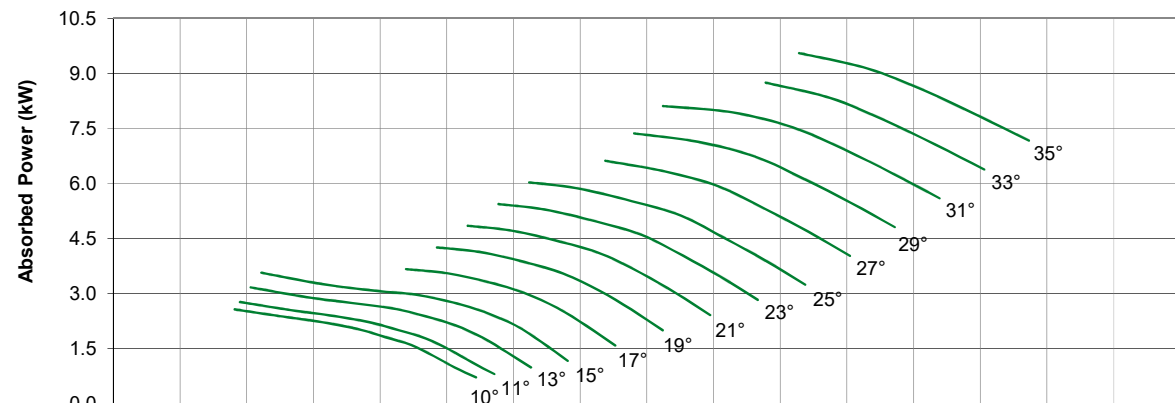
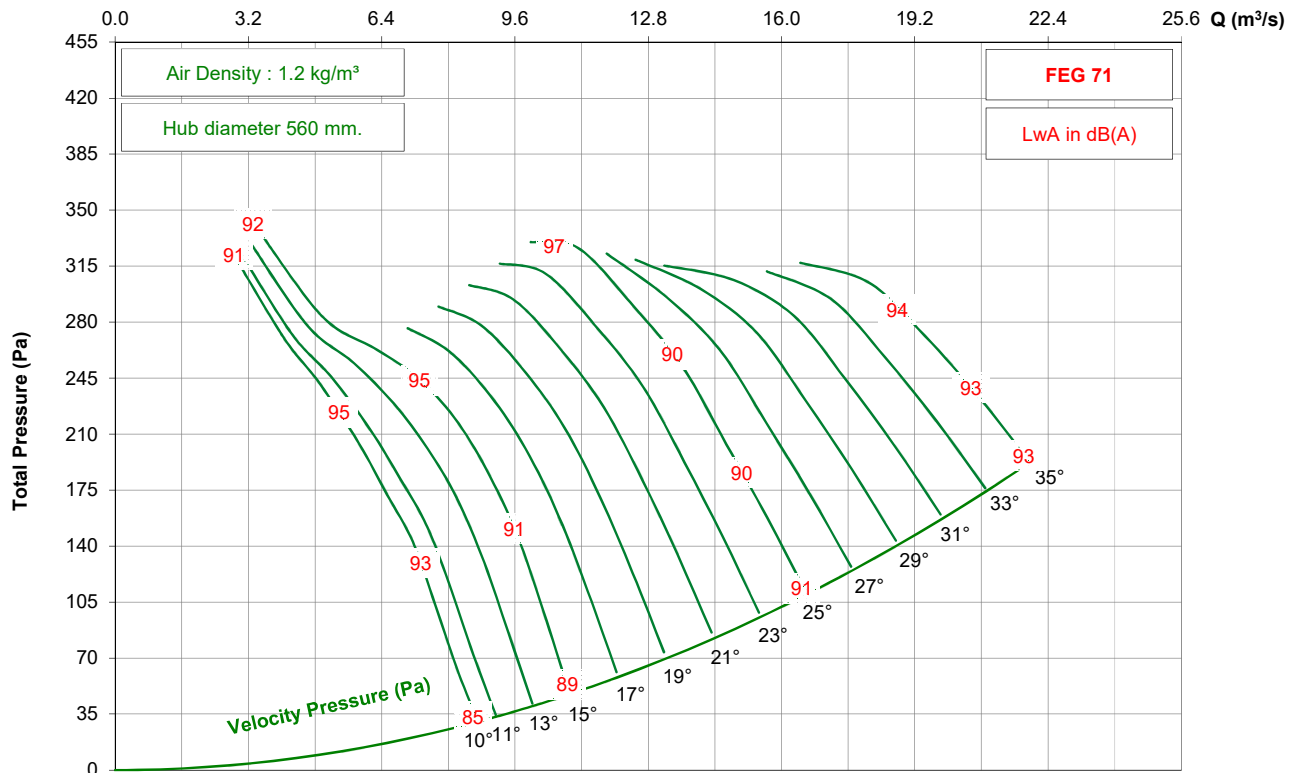

- Performance certified is for installation type D - ducted inlet, ducted outlet. Performance ratings do not include the effects of appurtenances (accessories).
 - The A-weighted sound ratings shown have been calculated per AMCA International Standard 301. Values shown are for inlet Lwi(A) sound power levels for installation type D - ducted inlet, ducted outlet. Ratings include the effects of duct end correction.

KTF1250 / RB22 / H / 12-7V (Forward)

1150 rpm - 60 Hz

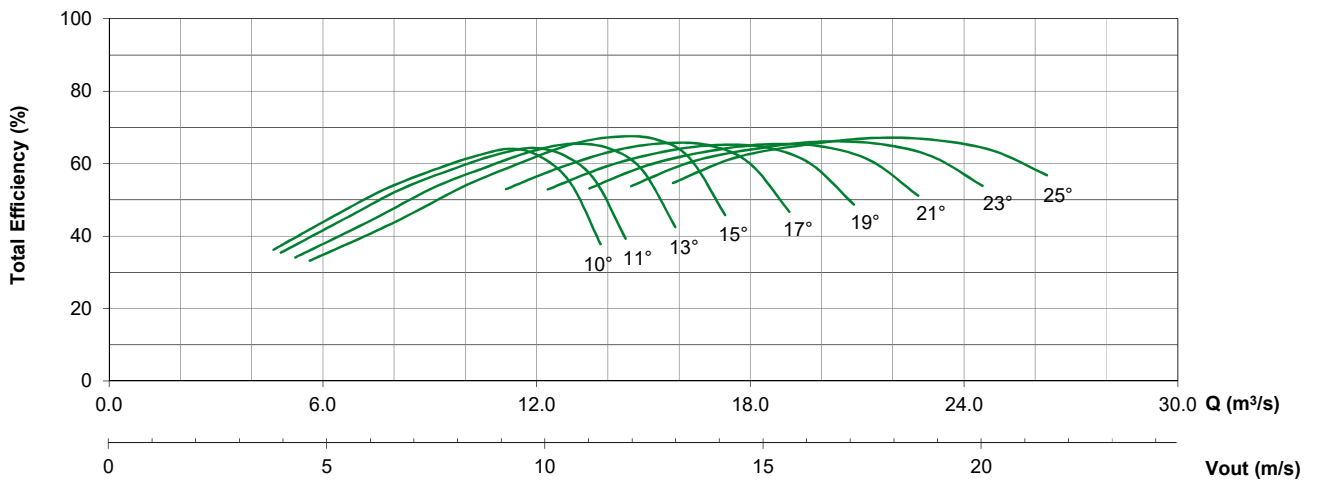
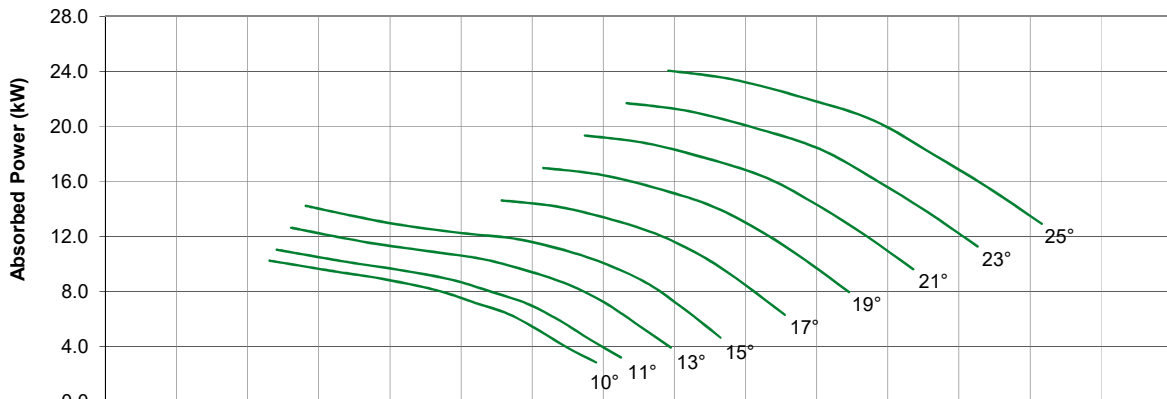
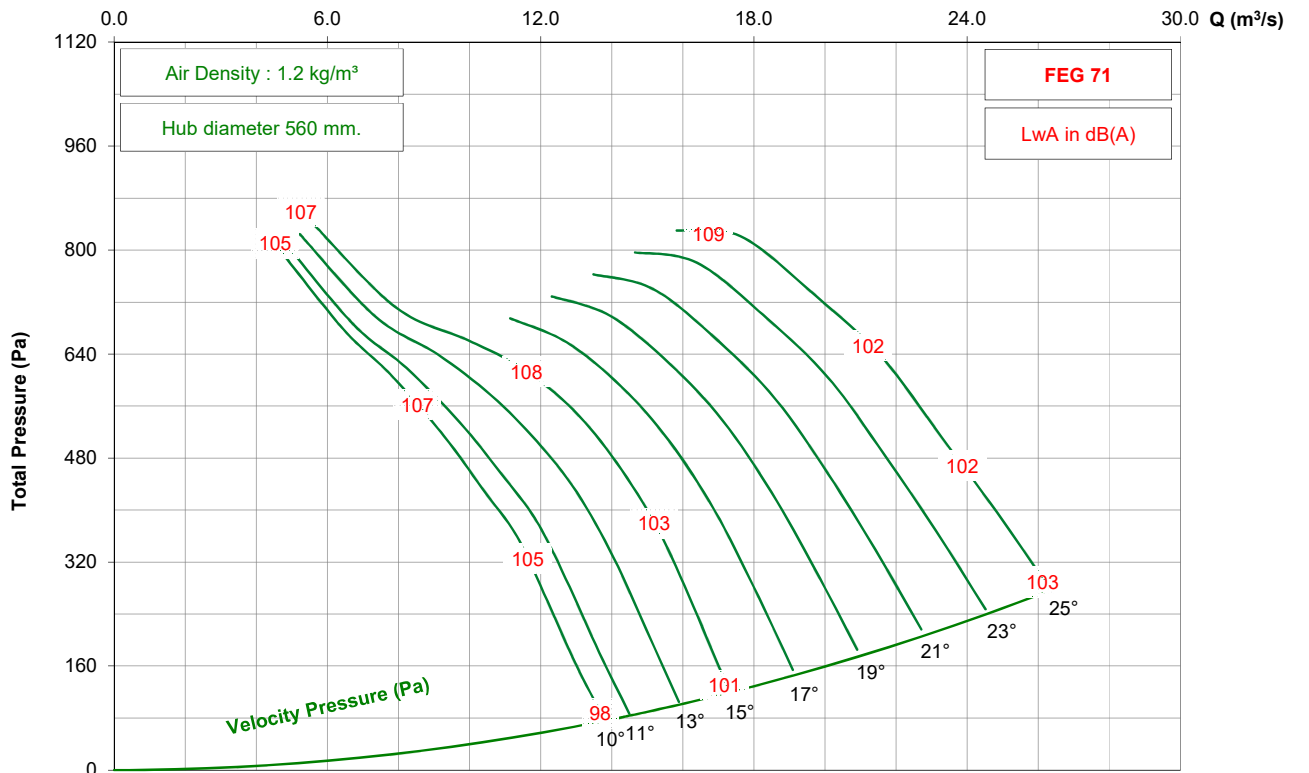

- Performance certified is for installation type D - ducted inlet, ducted outlet. Performance ratings do not include the effects of appurtenances (accessories).
 - The A-weighted sound ratings shown have been calculated per AMCA International Standard 301. Values shown are for inlet Lwi(A) sound power levels for installation type D - ducted inlet, ducted outlet. Ratings include the effects of duct end correction.

KTF1250 / RB22 / H / 12-7V (Forward)

875 rpm - 60 Hz

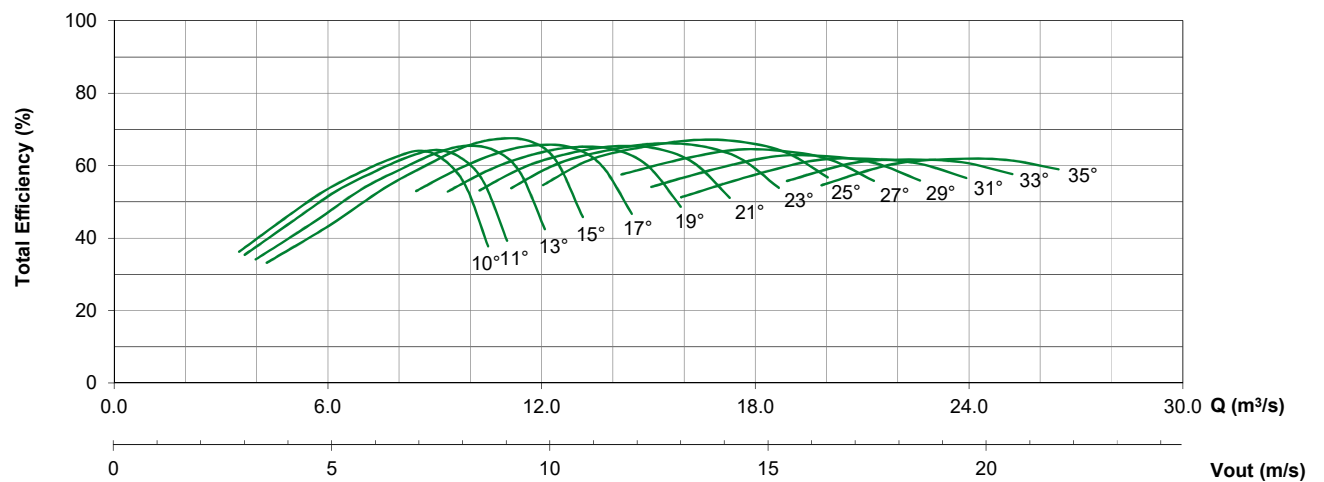
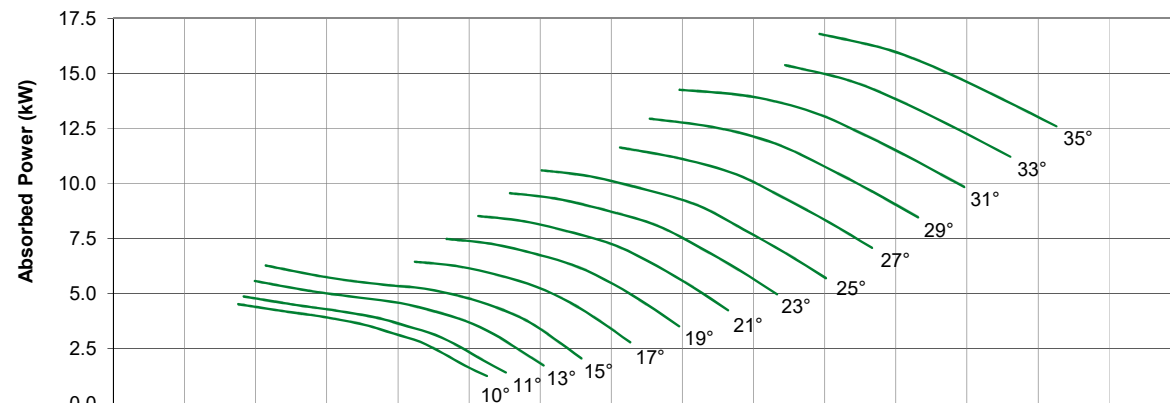
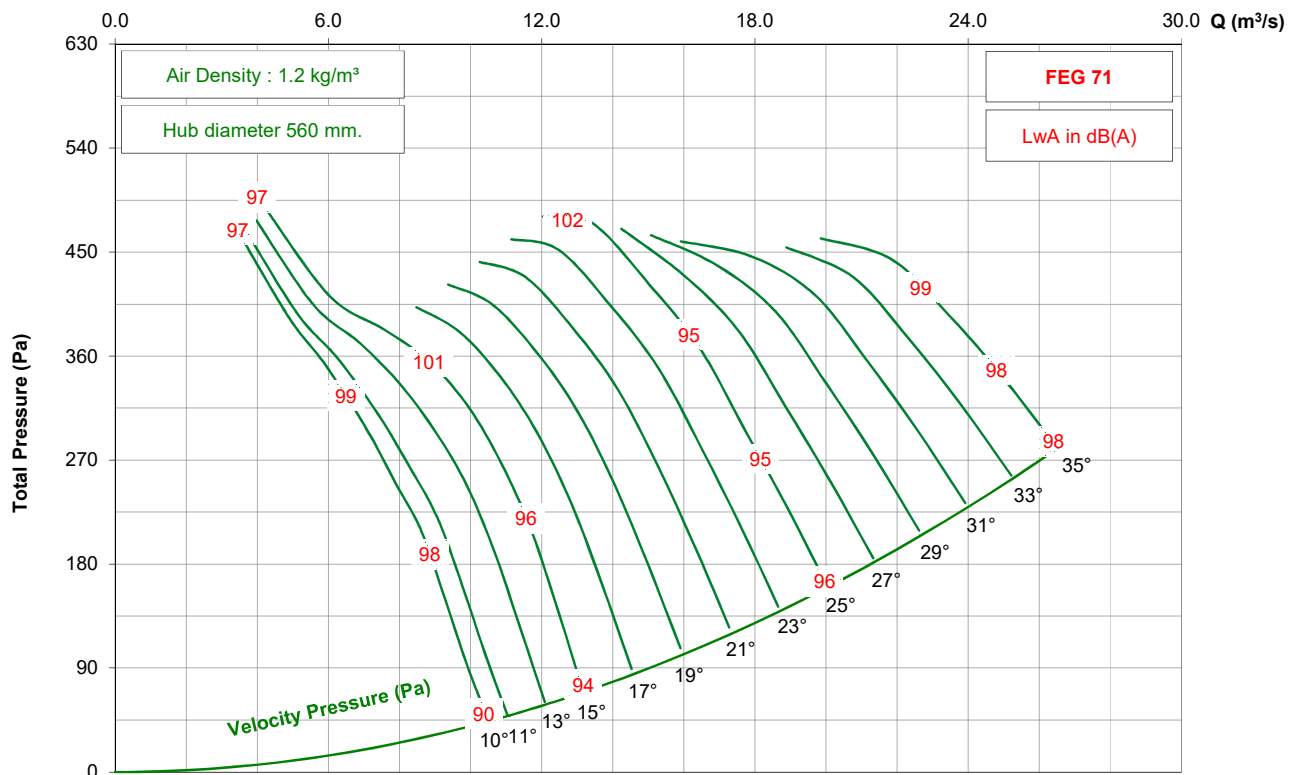

- Performance certified is for installation type D - ducted inlet, ducted outlet. Performance ratings do not include the effects of appurtenances (accessories).
 - The A-weighted sound ratings shown have been calculated per AMCA International Standard 301. Values shown are for inlet Lwi(A) sound power levels for installation type D - ducted inlet, ducted outlet. Ratings include the effects of duct end correction.

KTF1250 / RB22 / H / 12-7V (Reverse)

1450 rpm - 50 Hz

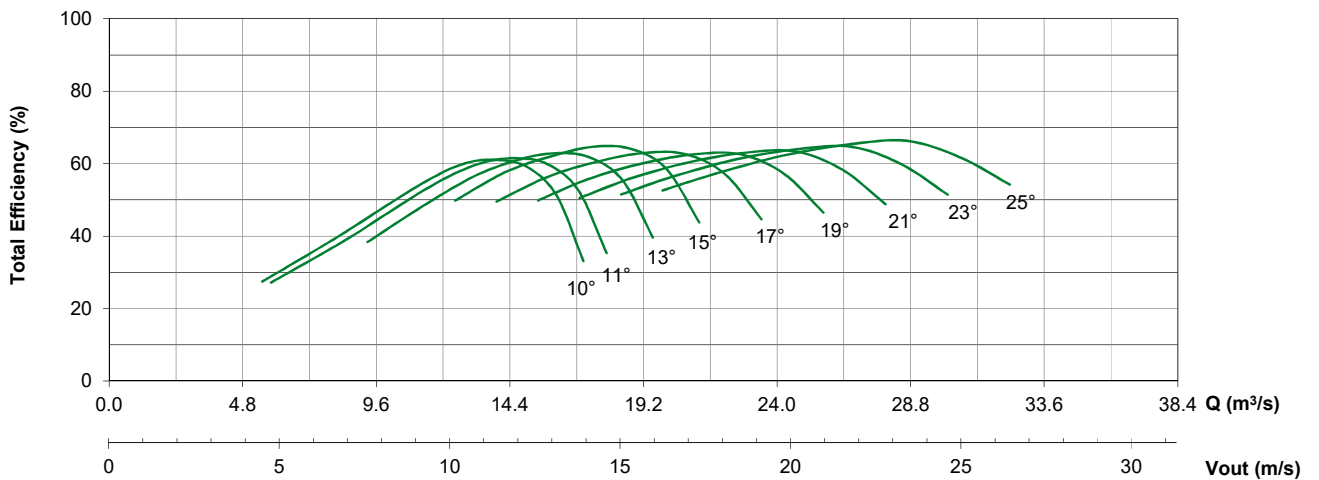
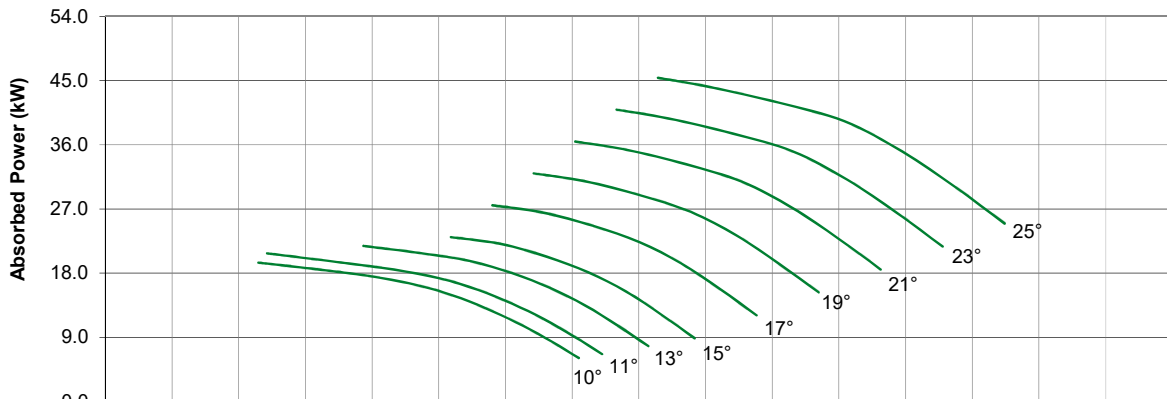
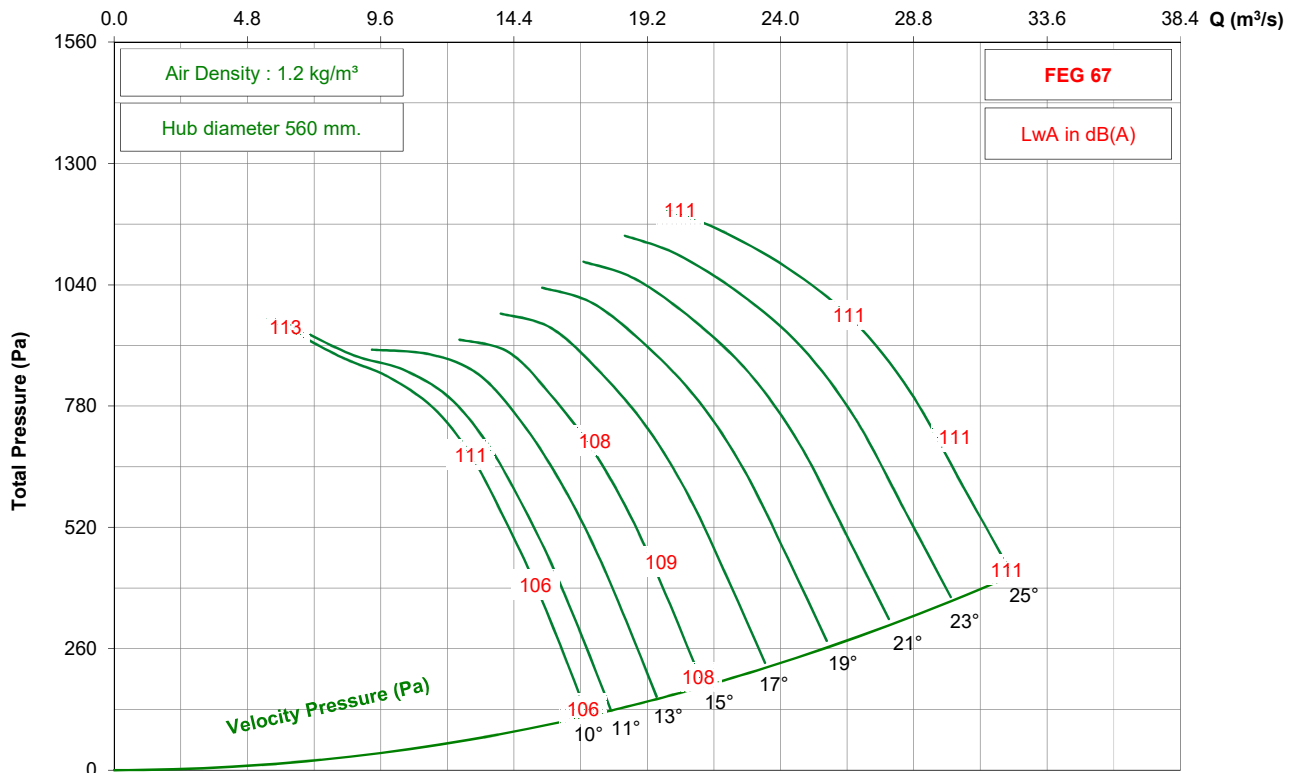

- Performance certified is for installation type D - ducted inlet, ducted outlet. Performance ratings do not include the effects of appurtenances (accessories).
 - The A-weighted sound ratings shown have been calculated per AMCA International Standard 301. Values shown are for inlet Lwi(A) sound power levels for installation type D - ducted inlet, ducted outlet. Ratings include the effects of duct end correction.

KTF1250 / RB22 / H / 12-7V (Reverse)

950 rpm - 50 Hz

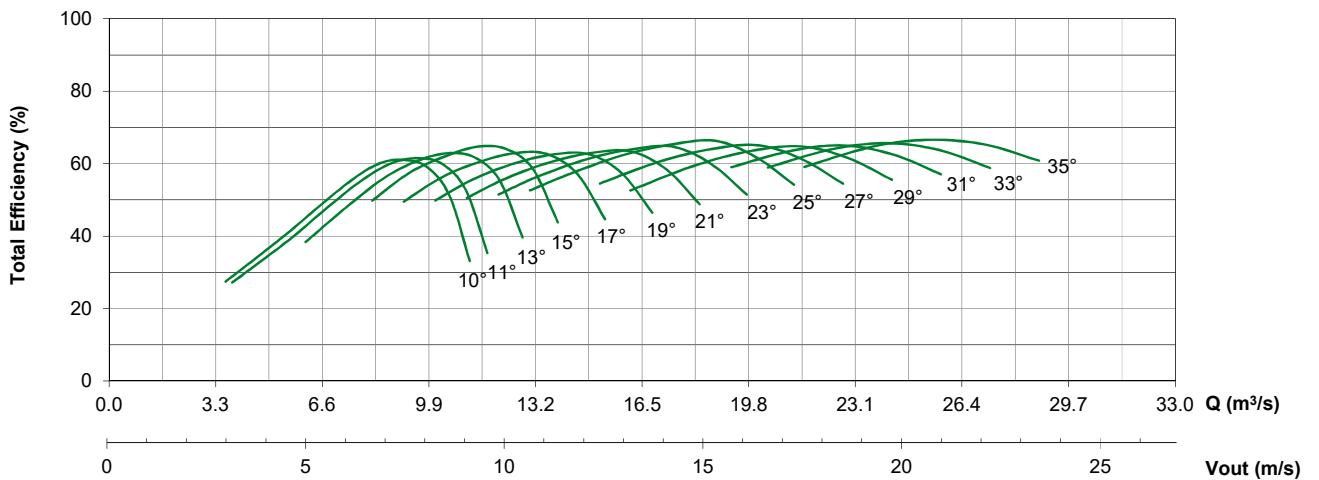
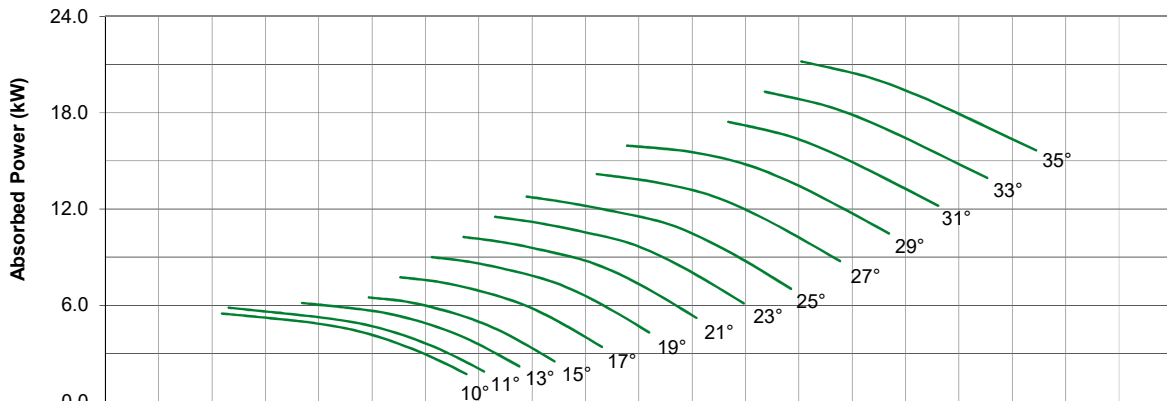
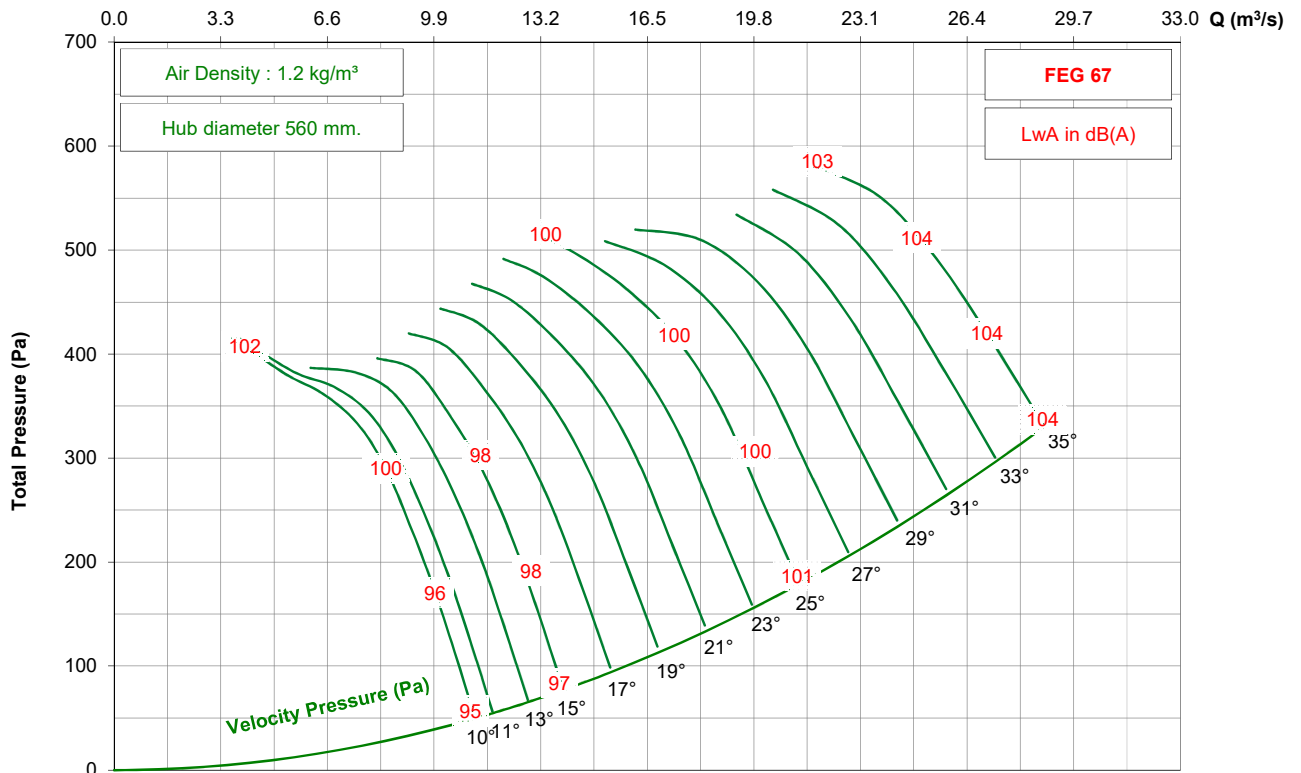

- Performance certified is for installation type D - ducted inlet, ducted outlet. Performance ratings do not include the effects of appurtenances (accessories).

- The A-weighted sound ratings shown have been calculated per AMCA International Standard 301. Values shown are for inlet Lwi(A) sound power levels for installation type D - ducted inlet, ducted outlet. Ratings include the effects of duct end correction.

KTF1250 / RB22 / H / 12-7V (Reverse)

725 rpm - 50 Hz

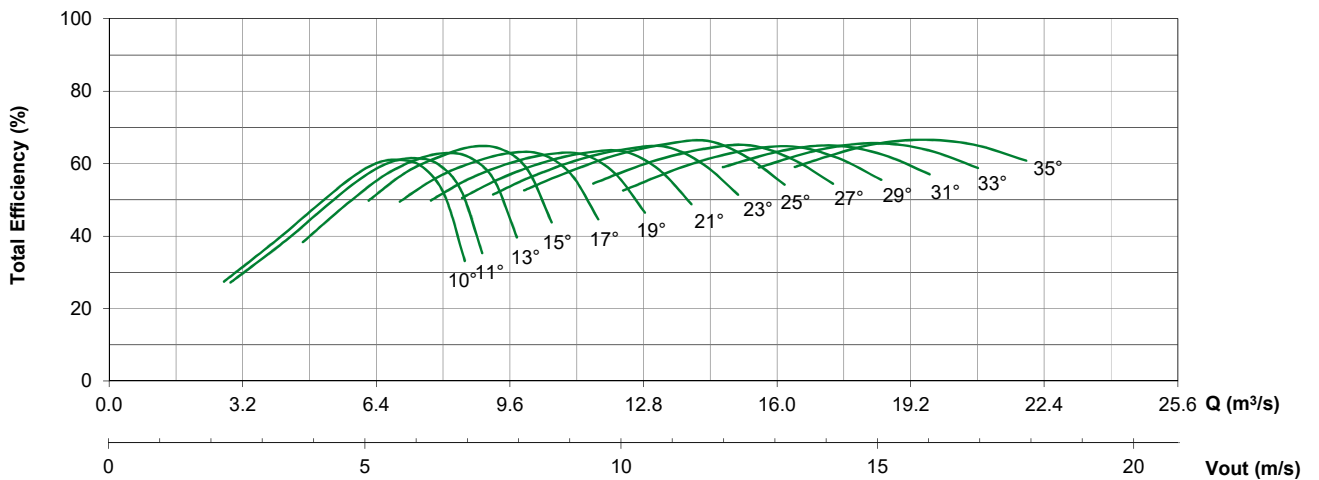
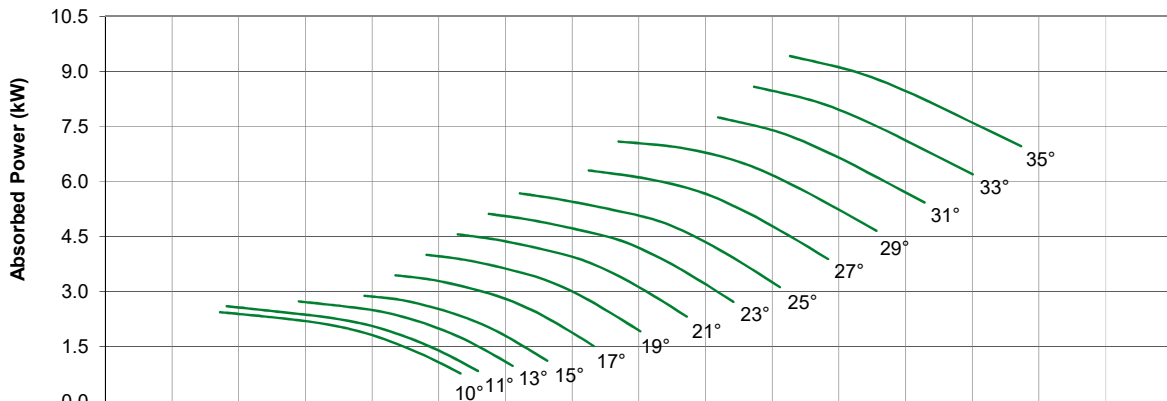
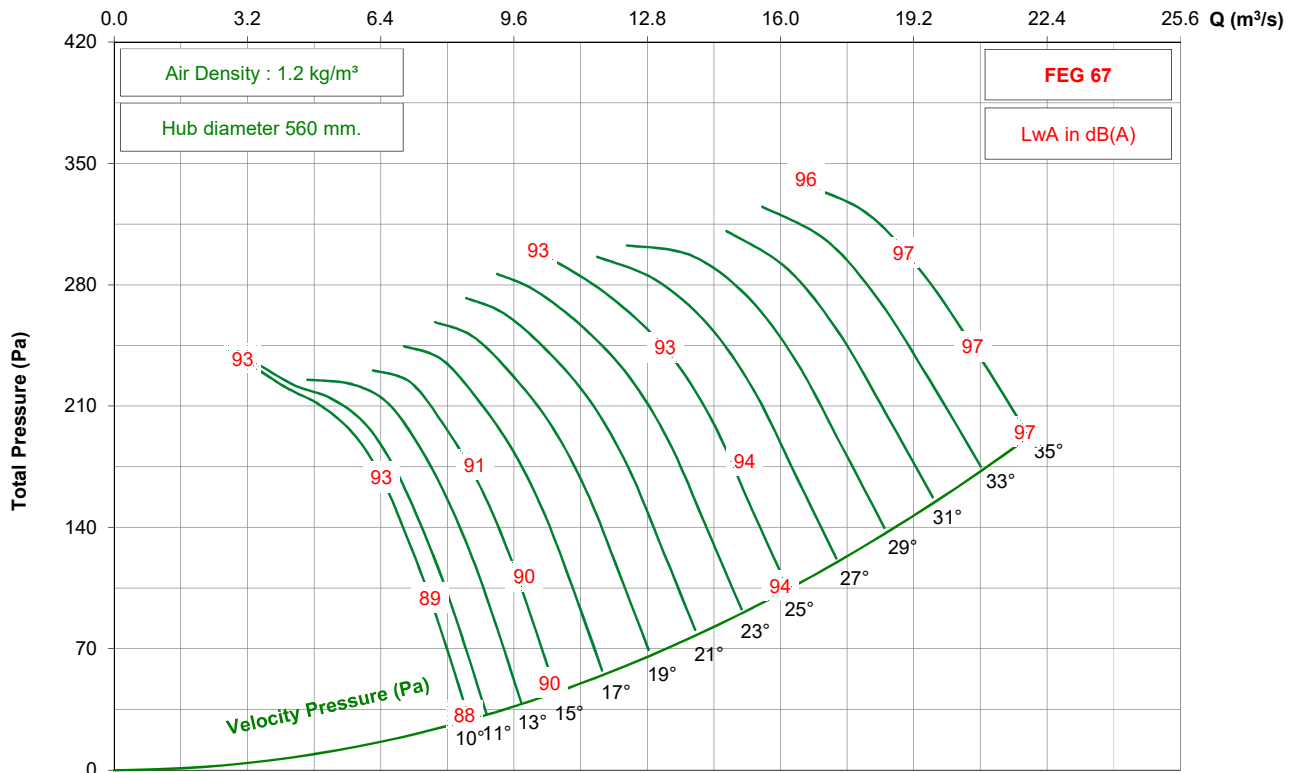

- Performance certified is for installation type D - ducted inlet, ducted outlet. Performance ratings do not include the effects of appurtenances (accessories).
 - The A-weighted sound ratings shown have been calculated per AMCA International Standard 301. Values shown are for inlet Lwi(A) sound power levels for installation type D - ducted inlet, ducted outlet. Ratings include the effects of duct end correction.

KTF1250 / RB22 / H / 12-7V (Reverse)

1150 rpm - 60 Hz

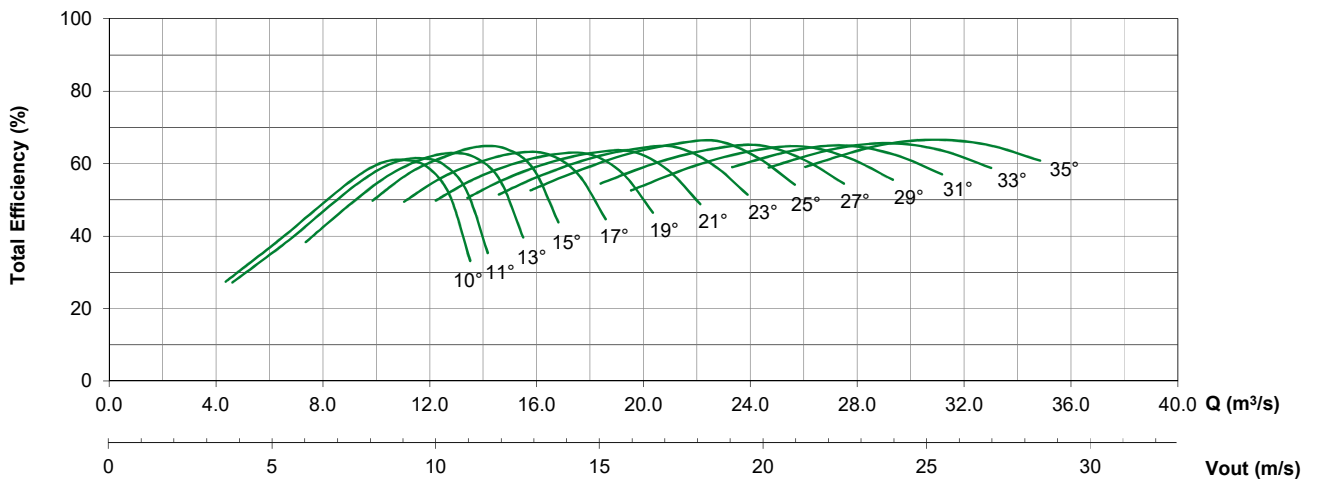
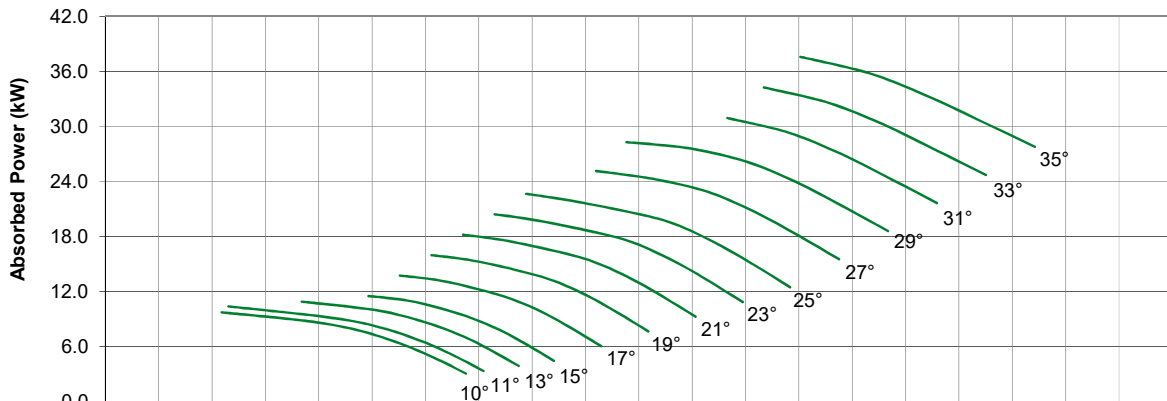
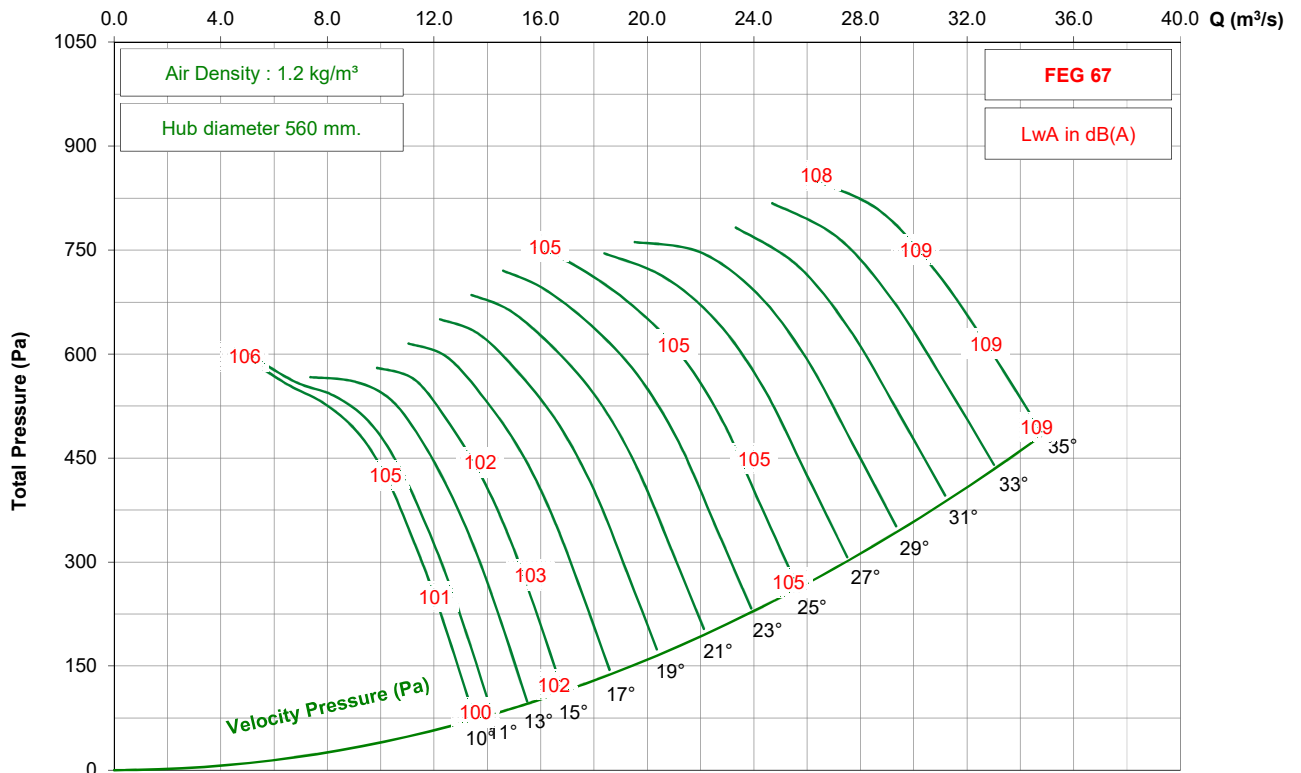

- Performance certified is for installation type D - ducted inlet, ducted outlet. Performance ratings do not include the effects of appurtenances (accessories).

- The A-weighted sound ratings shown have been calculated per AMCA International Standard 301. Values shown are for inlet Lwi(A) sound power levels for installation type D - ducted inlet, ducted outlet. Ratings include the effects of duct end correction.

KTF1250 / RB22 / H / 12-7V (Reverse)

875 rpm - 60 Hz

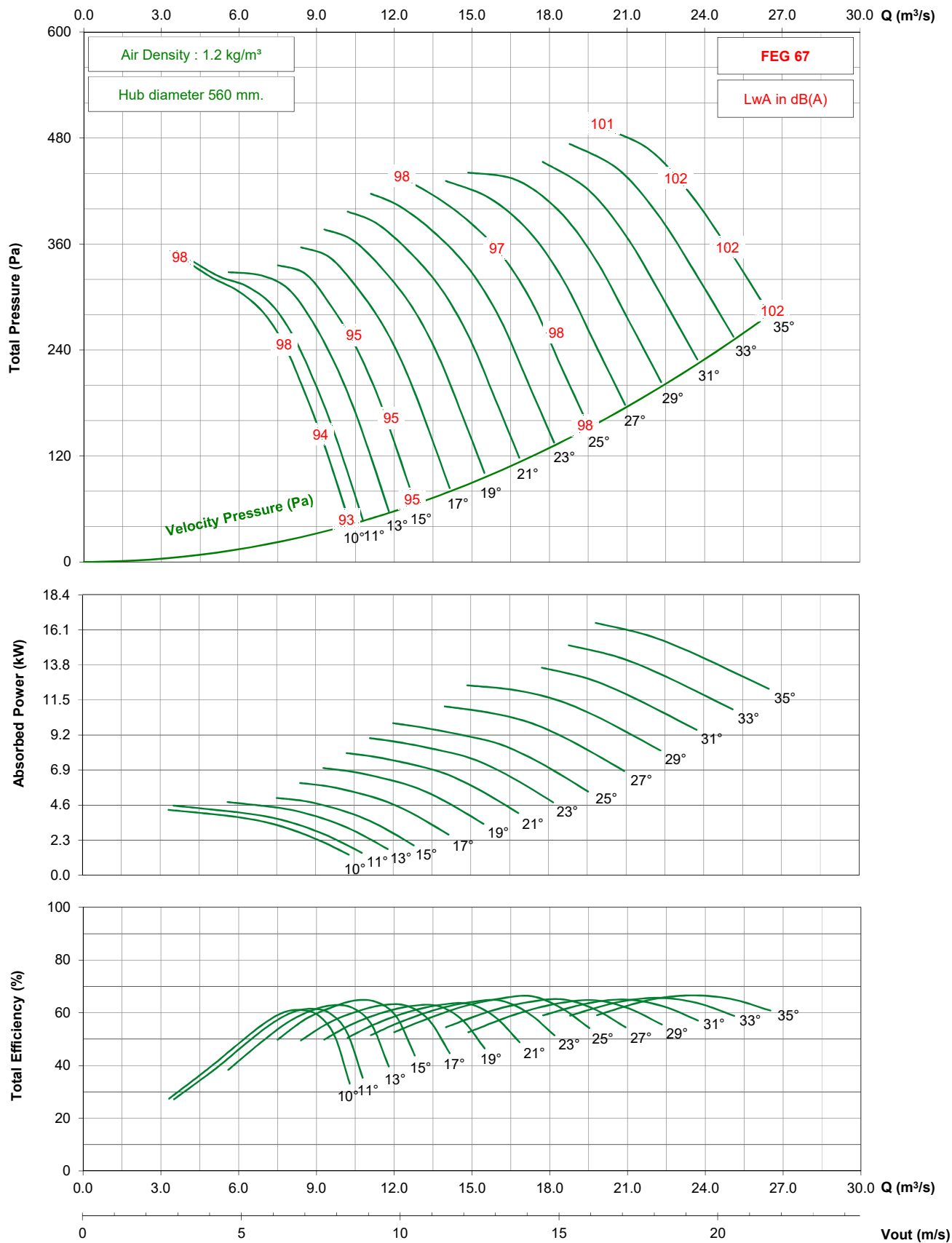

- Performance certified is for installation type D - ducted inlet, ducted outlet. Performance ratings do not include the effects of appurtenances (accessories).
 - The A-weighted sound ratings shown have been calculated per AMCA International Standard 301. Values shown are for inlet Lwi(A) sound power levels for installation type D - ducted inlet, ducted outlet. Ratings include the effects of duct end correction.

KTF1400 / RB25 / H / 12-7V (Forward)

1450 rpm - 50 Hz

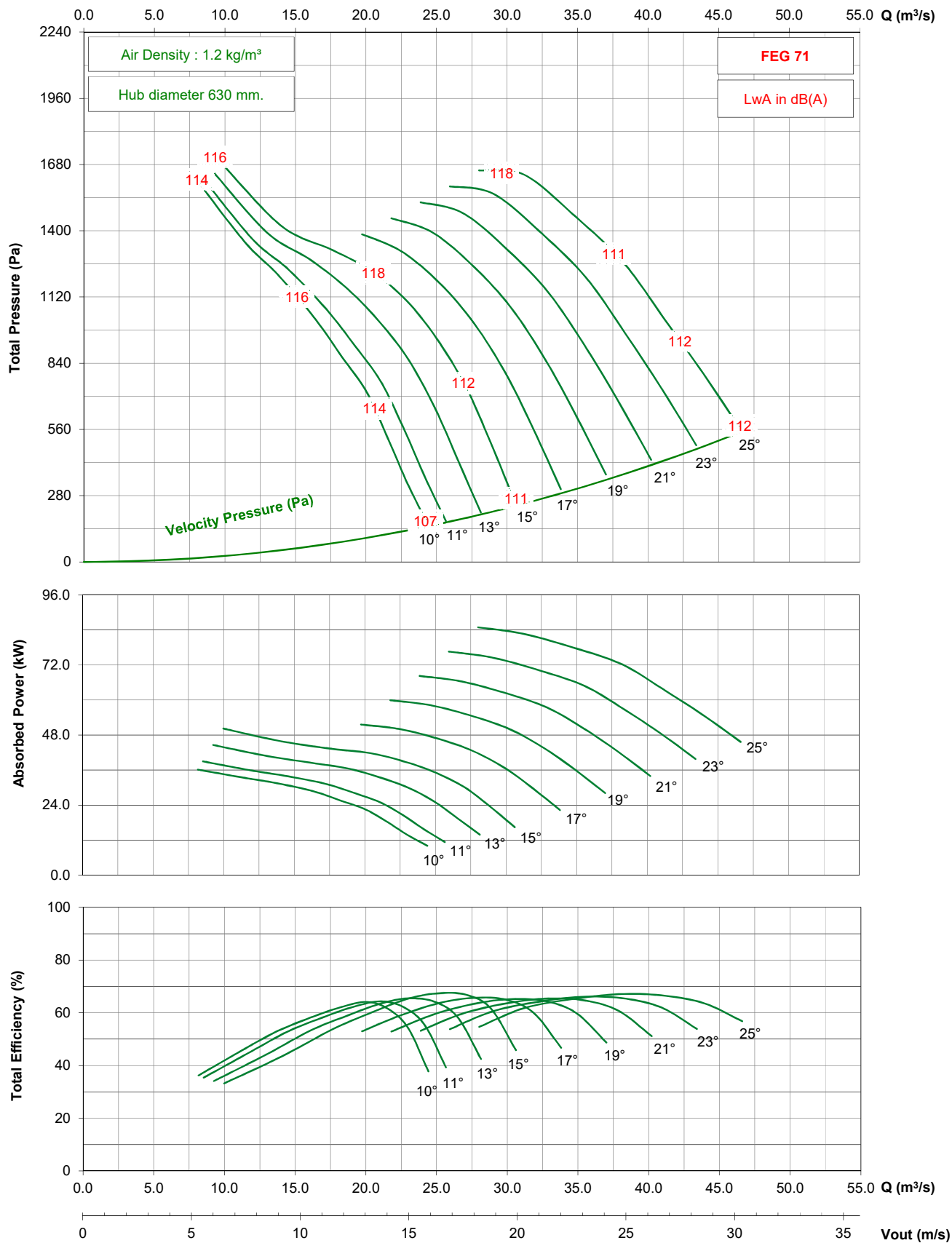

- Performance certified is for installation type D - ducted inlet, ducted outlet. Performance ratings do not include the effects of appurtenances (accessories).
 - The A-weighted sound ratings shown have been calculated per AMCA International Standard 301. Values shown are for inlet Lwi(A) sound power levels for installation type D - ducted inlet, ducted outlet. Ratings include the effects of duct end correction.

KTF1400 / RB25 / H / 12-7V (Forward)

950 rpm - 50 Hz

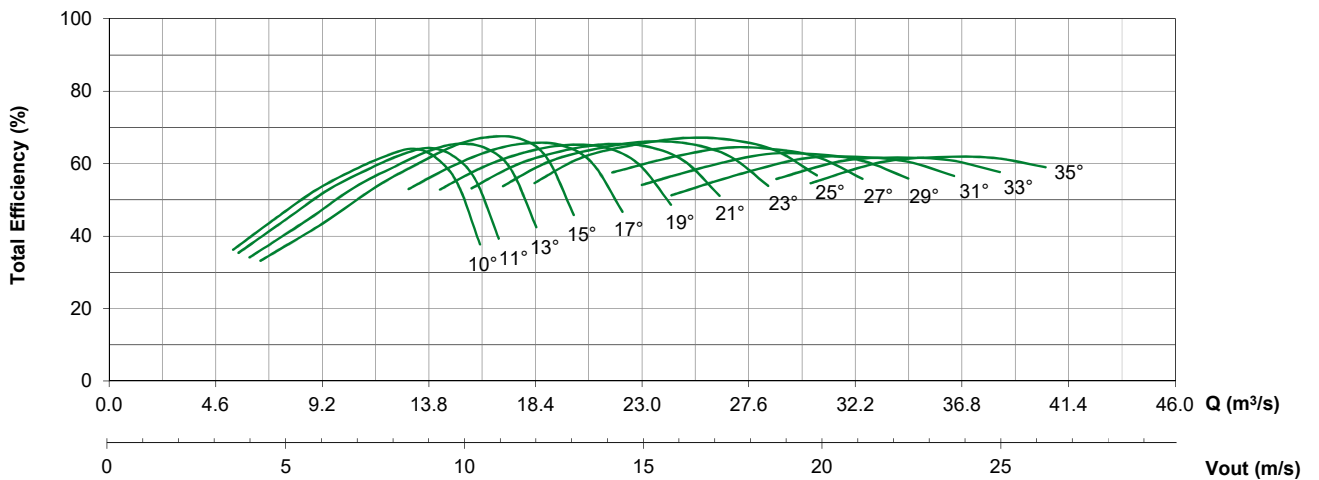
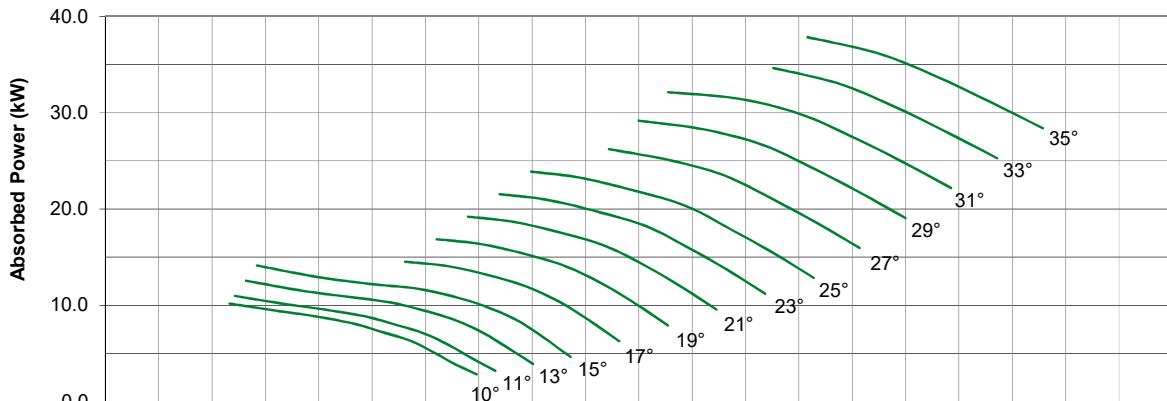
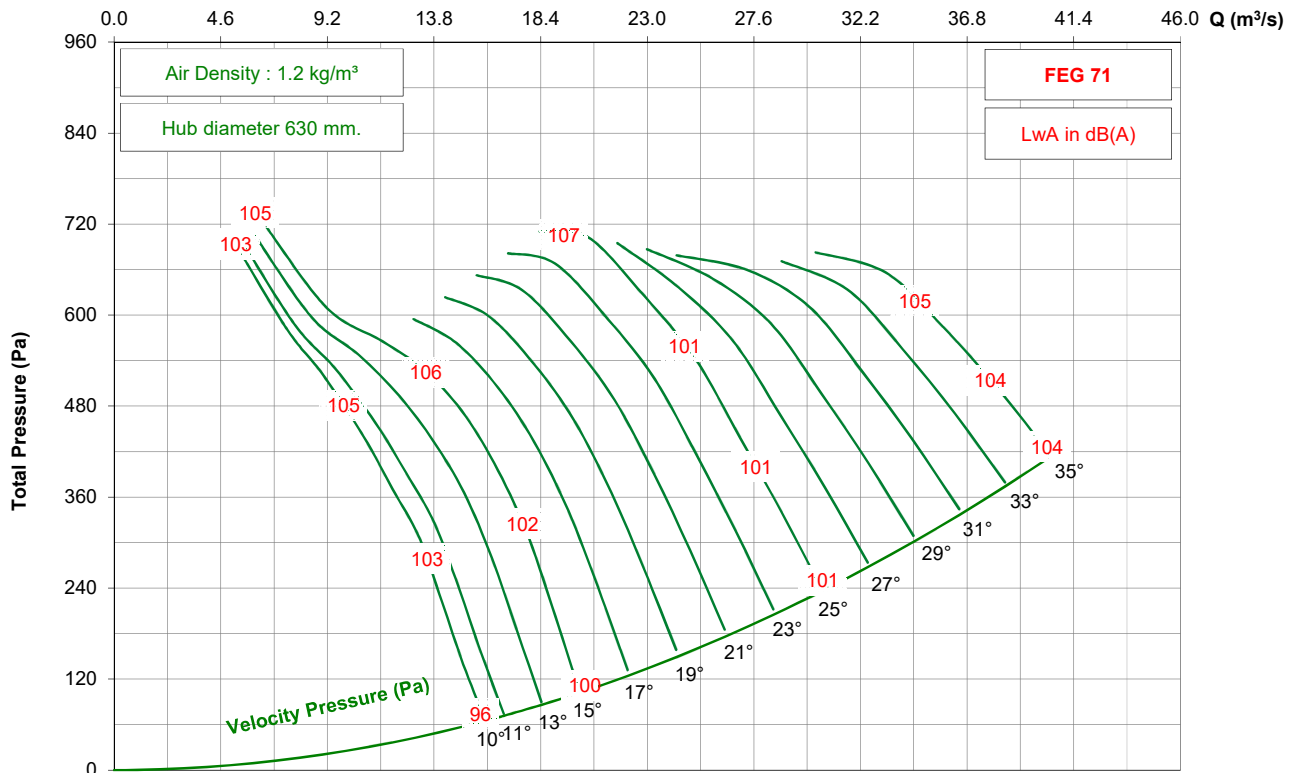

- Performance certified is for installation type D - ducted inlet, ducted outlet. Performance ratings do not include the effects of appurtenances (accessories).
 - The A-weighted sound ratings shown have been calculated per AMCA International Standard 301. Values shown are for inlet Lwi(A) sound power levels for installation type D - ducted inlet, ducted outlet. Ratings include the effects of duct end correction.

KTF1400 / RB25 / H / 12-7V (Forward)

725 rpm - 50 Hz

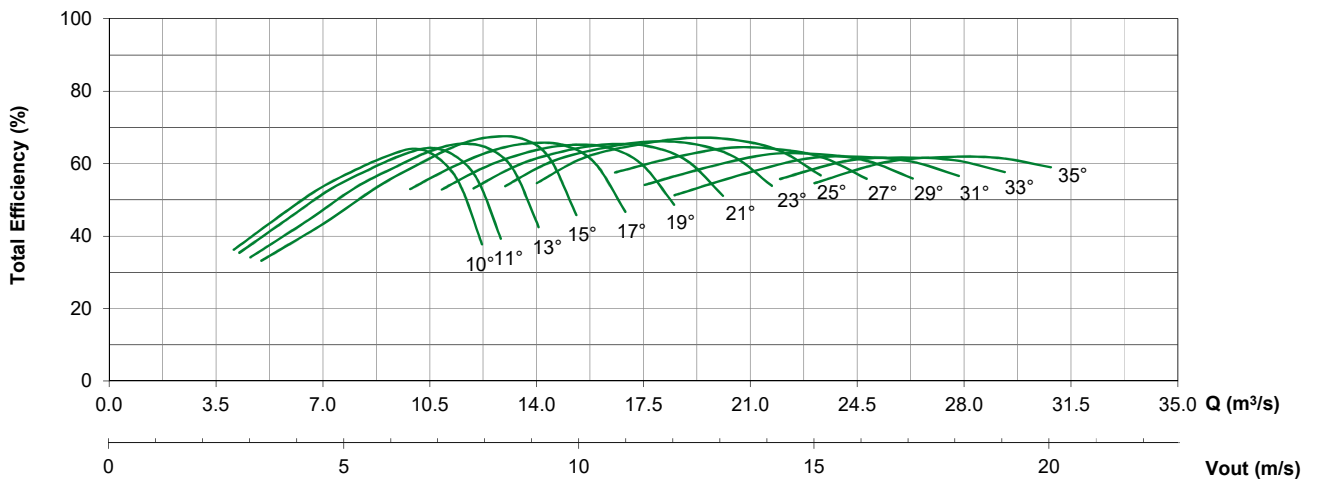
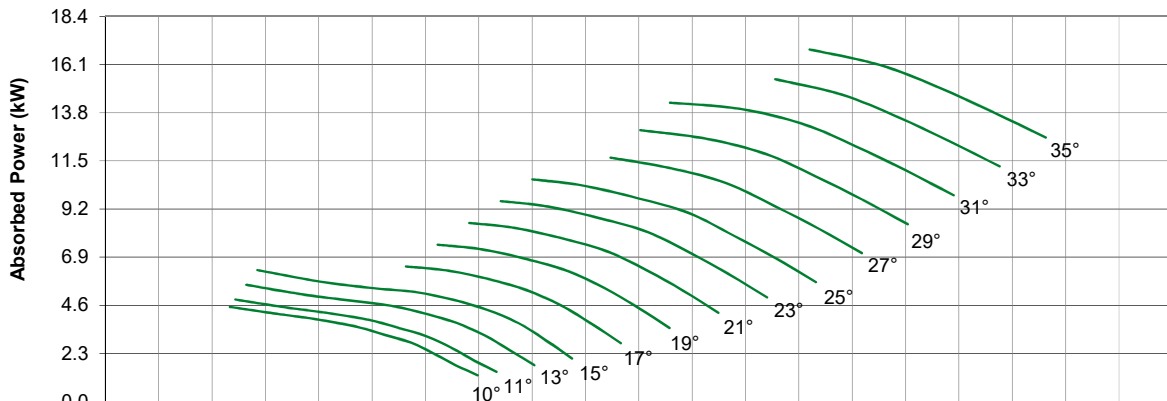
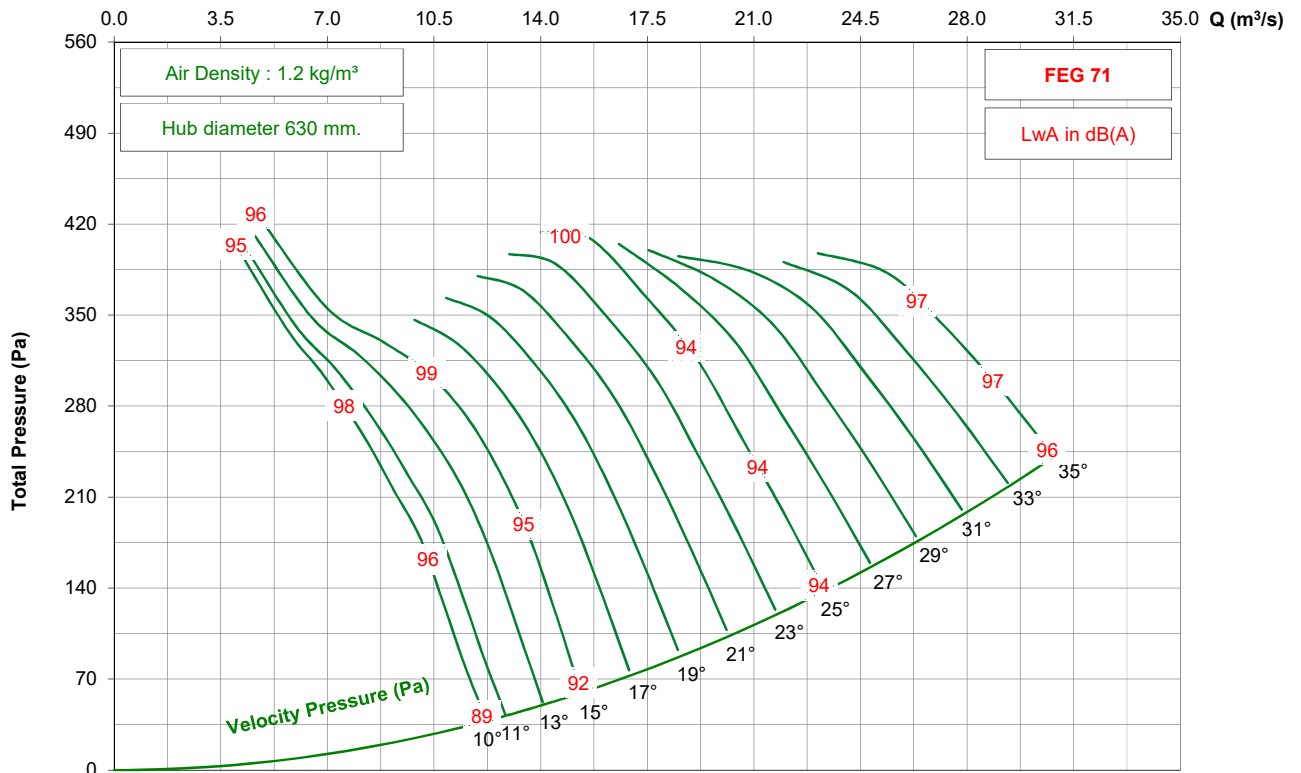

- Performance certified is for installation type D - ducted inlet, ducted outlet. Performance ratings do not include the effects of appurtenances (accessories).
 - The A-weighted sound ratings shown have been calculated per AMCA International Standard 301. Values shown are for inlet Lwi(A) sound power levels for installation type D - ducted inlet, ducted outlet. Ratings include the effects of duct end correction.

KTF1400 / RB25 / H / 12-7V (Forward)

1150 rpm - 60 Hz

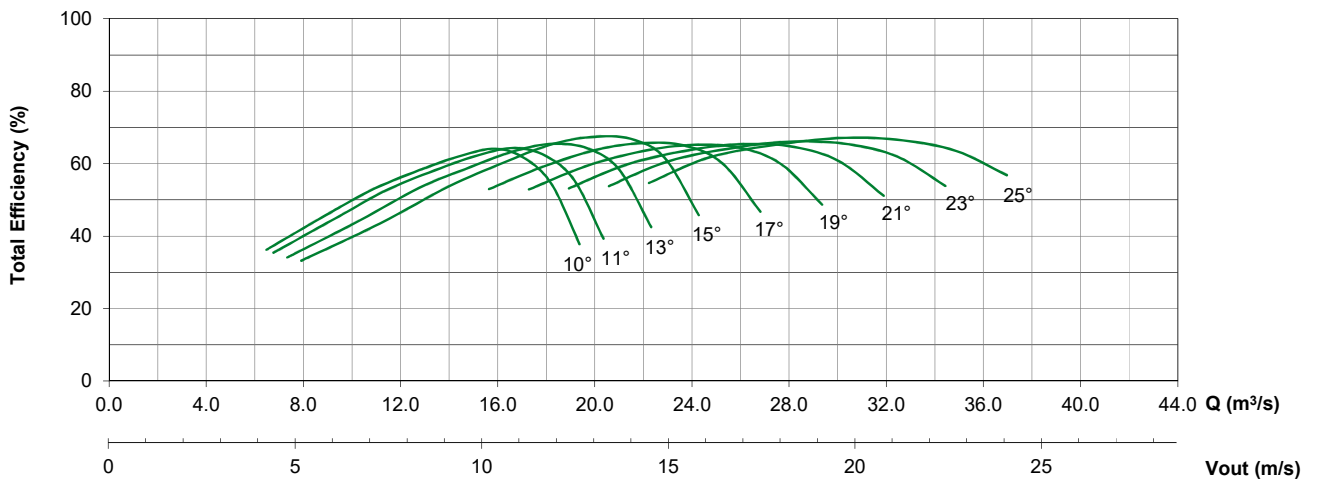
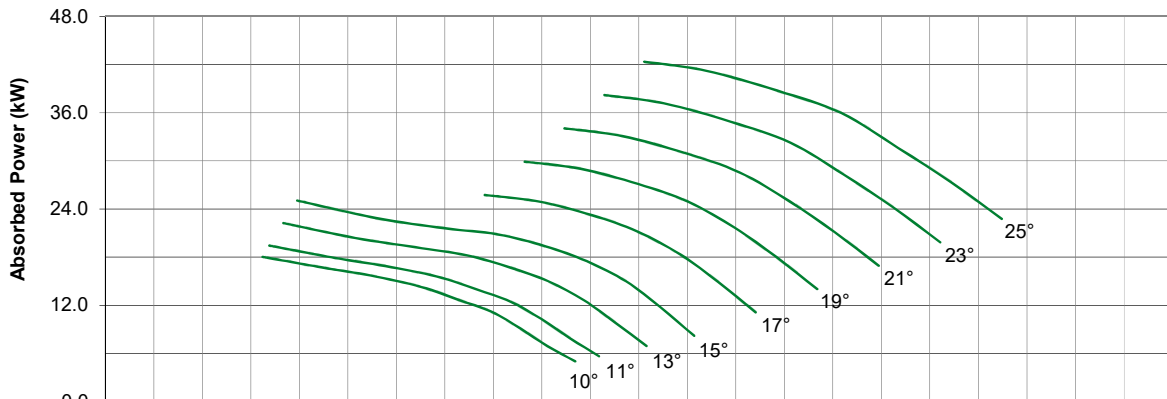
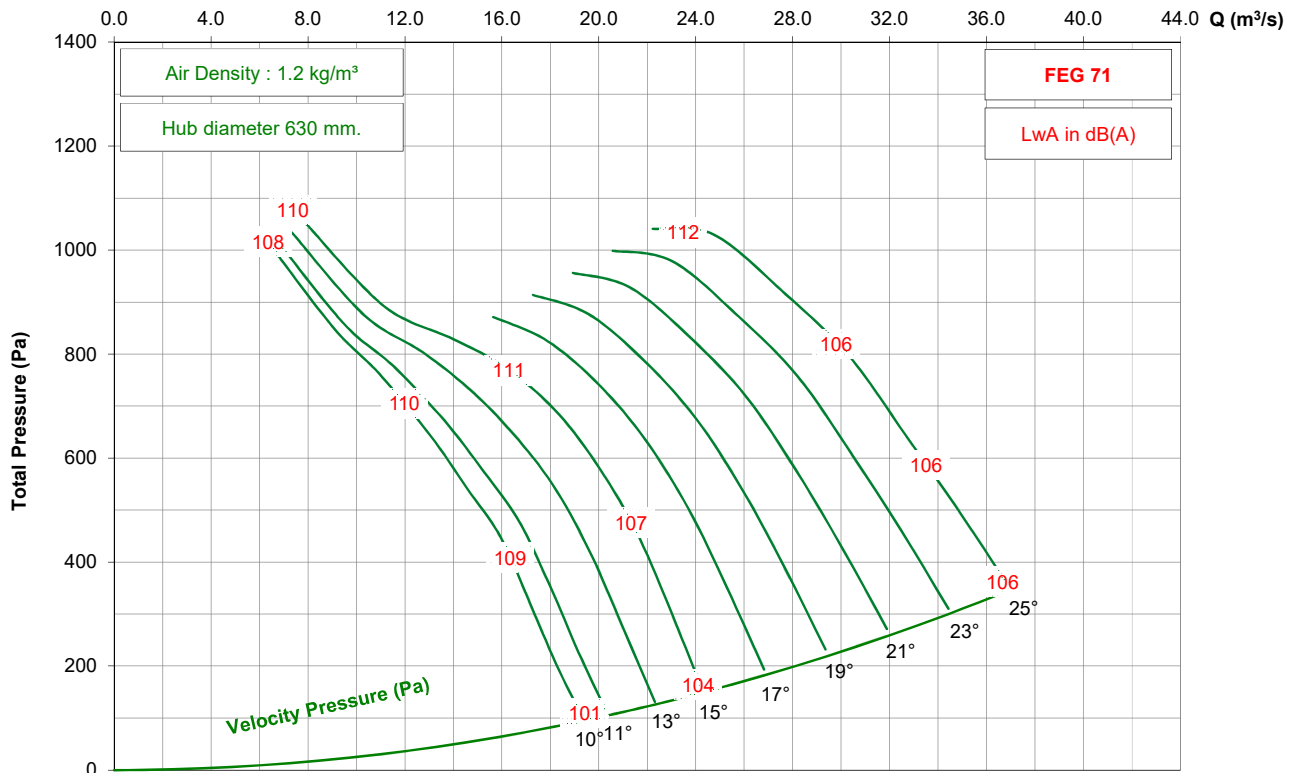

- Performance certified is for installation type D - ducted inlet, ducted outlet. Performance ratings do not include the effects of appurtenances (accessories).
 - The A-weighted sound ratings shown have been calculated per AMCA International Standard 301. Values shown are for inlet Lwi(A) sound power levels for installation type D - ducted inlet, ducted outlet. Ratings include the effects of duct end correction.

KTF1400 / RB25 / H / 12-7V (Forward)

875 rpm - 60 Hz

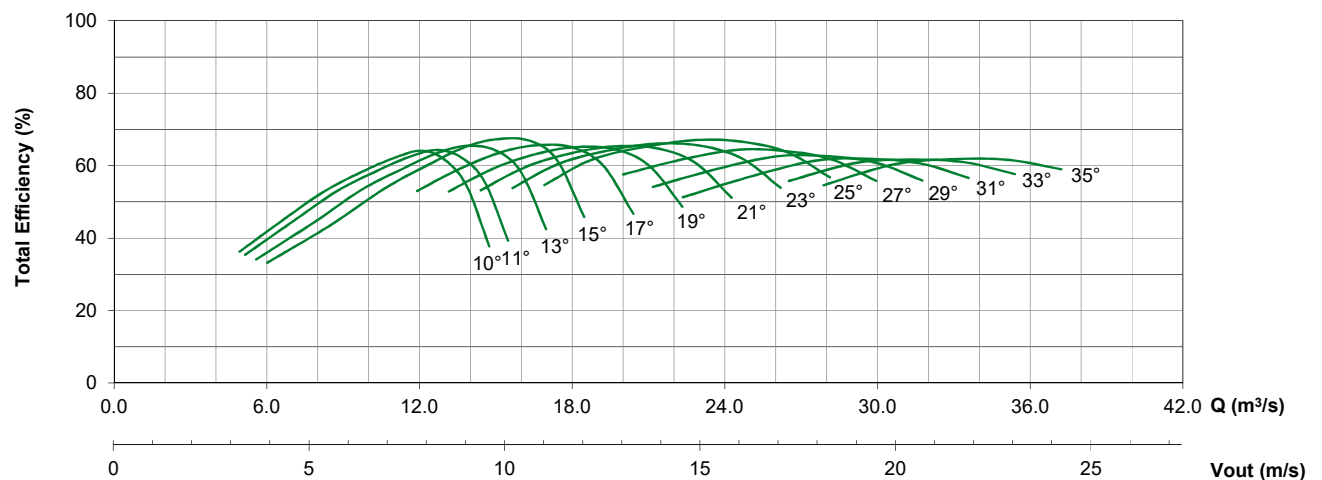
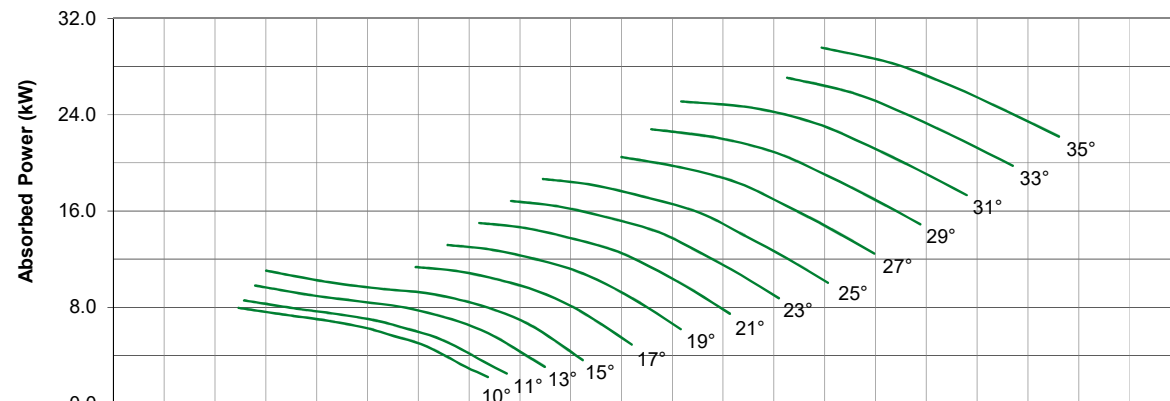
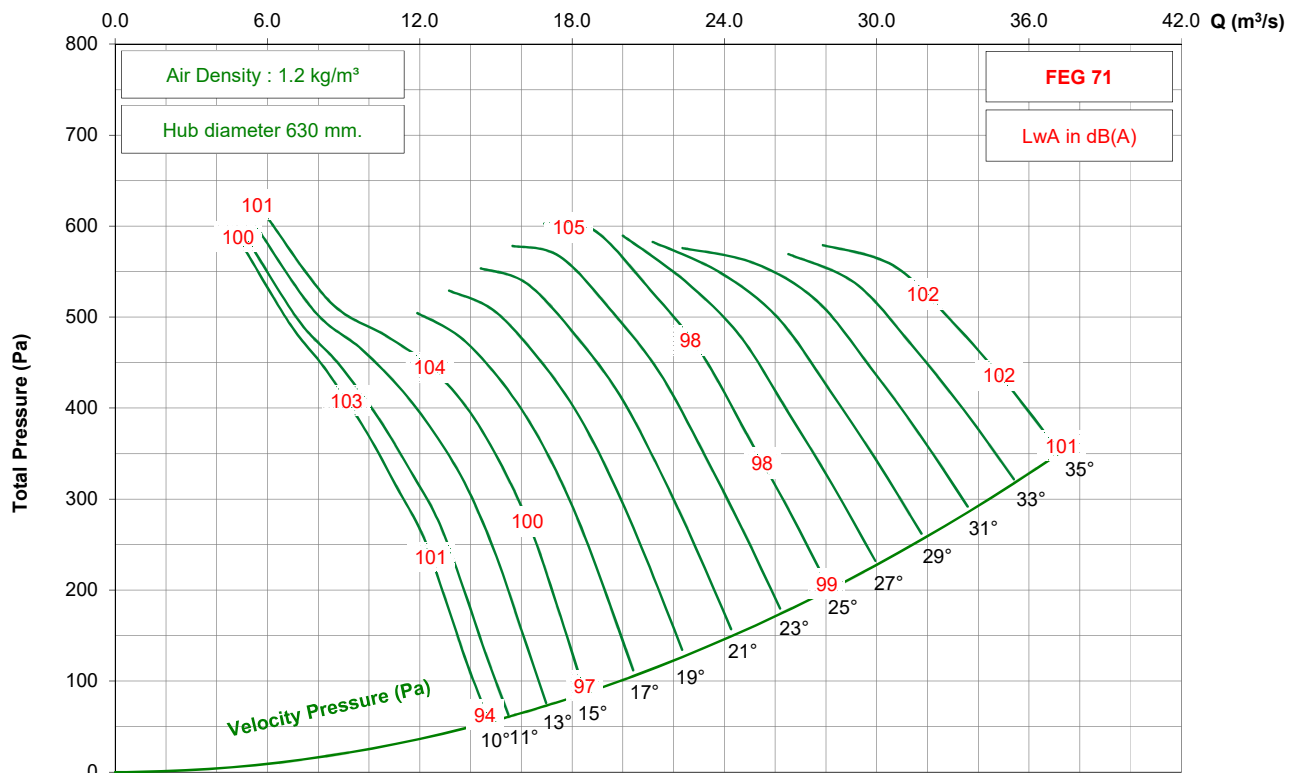

- Performance certified is for installation type D - ducted inlet, ducted outlet. Performance ratings do not include the effects of appurtenances (accessories).

- The A-weighted sound ratings shown have been calculated per AMCA International Standard 301. Values shown are for inlet Lwi(A) sound power levels for installation type D - ducted inlet, ducted outlet. Ratings include the effects of duct end correction.

KTF1400 / RB25 / H / 12-7V (Reverse)

1450 rpm - 50 Hz

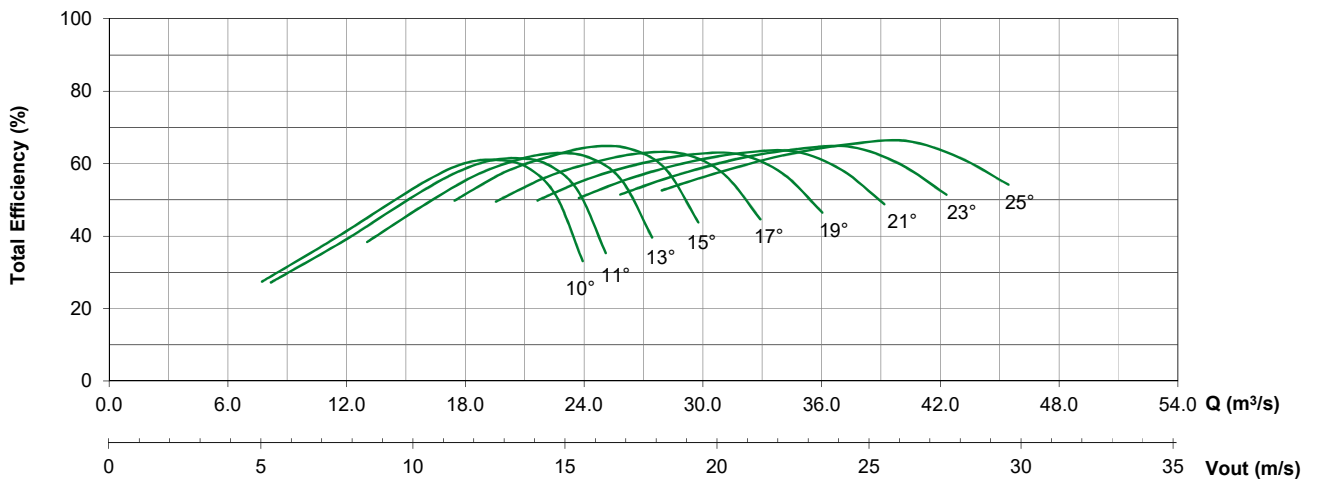
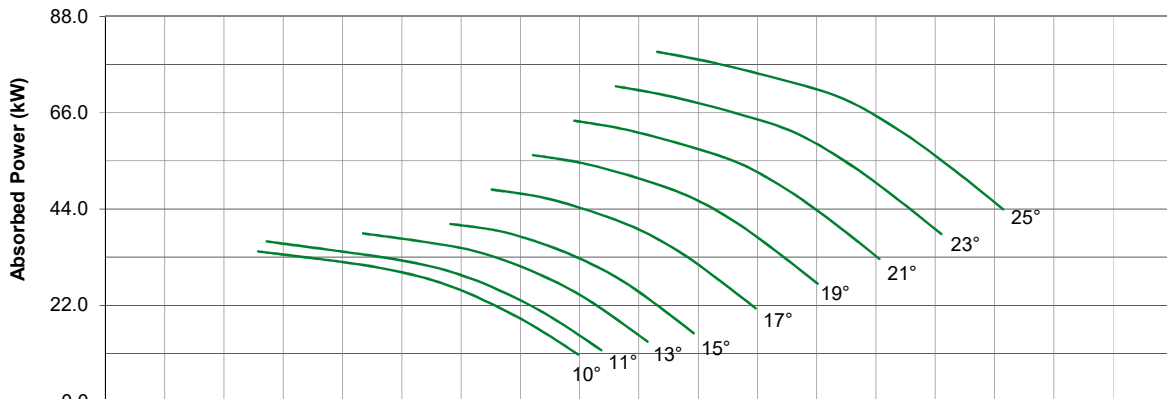
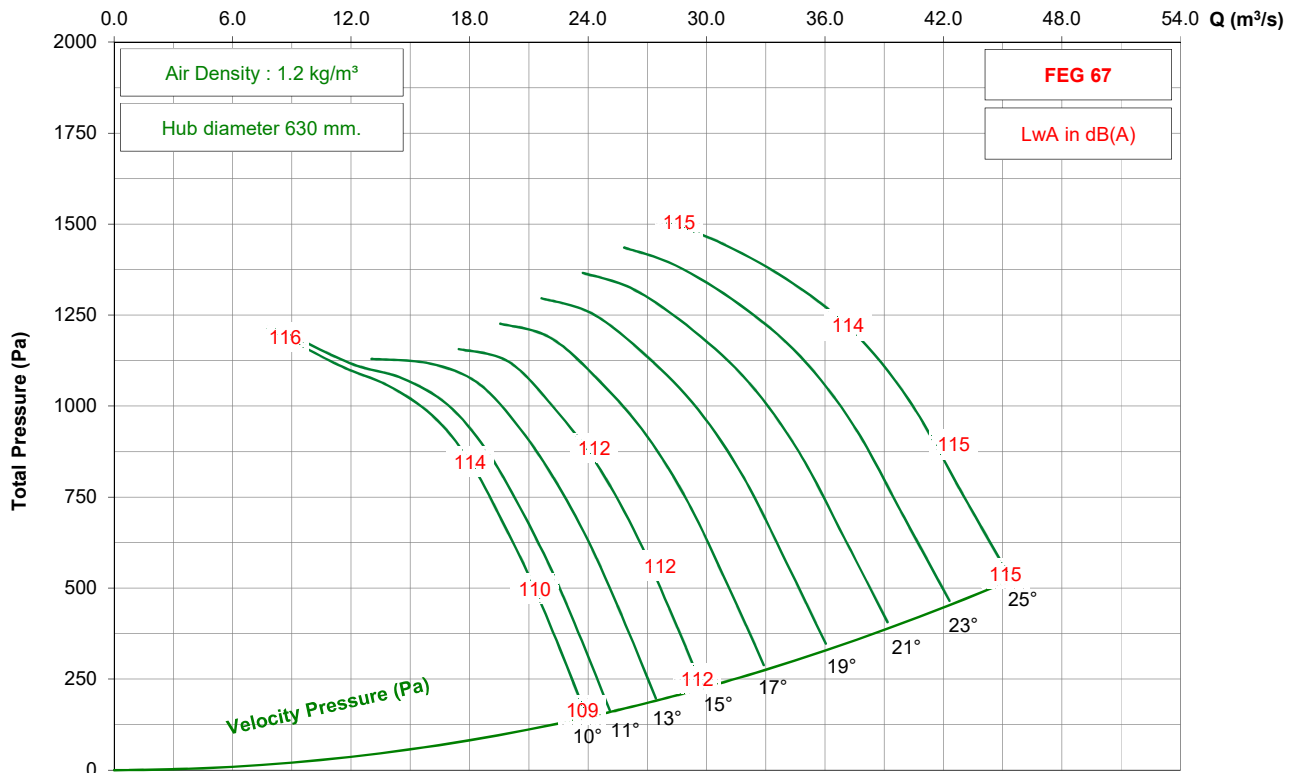

- Performance certified is for installation type D - ducted inlet, ducted outlet. Performance ratings do not include the effects of appurtenances (accessories).
 - The A-weighted sound ratings shown have been calculated per AMCA International Standard 301. Values shown are for inlet Lwi(A) sound power levels for installation type D - ducted inlet, ducted outlet. Ratings include the effects of duct end correction.

KTF1400 / RB25 / H / 12-7V (Reverse)

950 rpm - 50 Hz

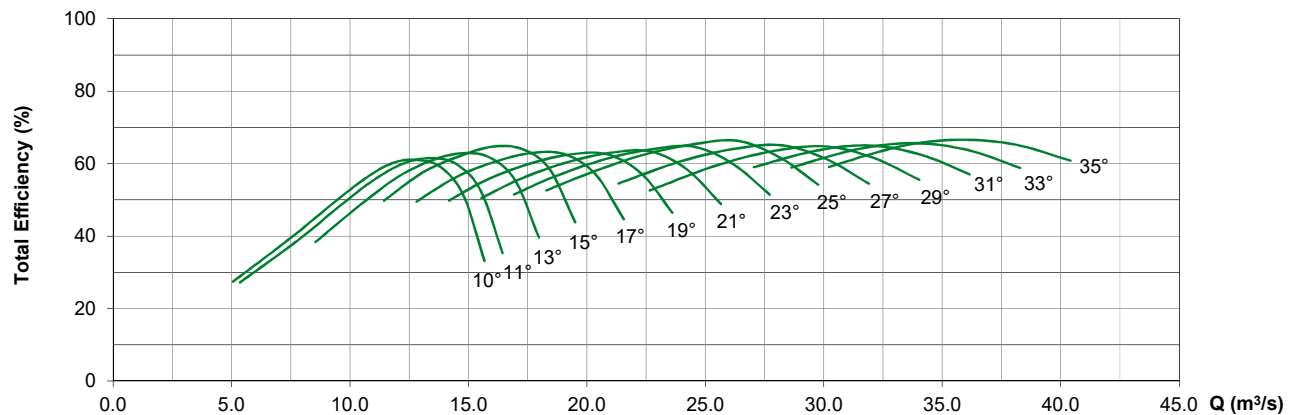
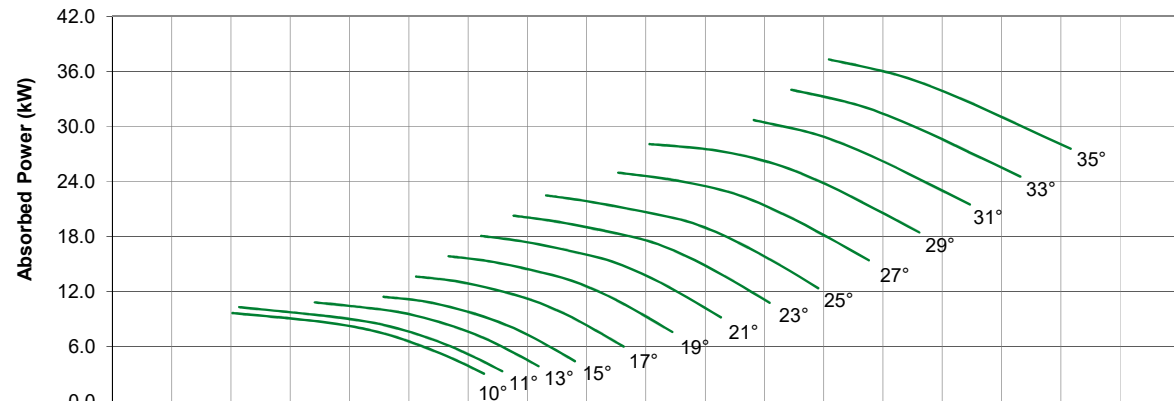
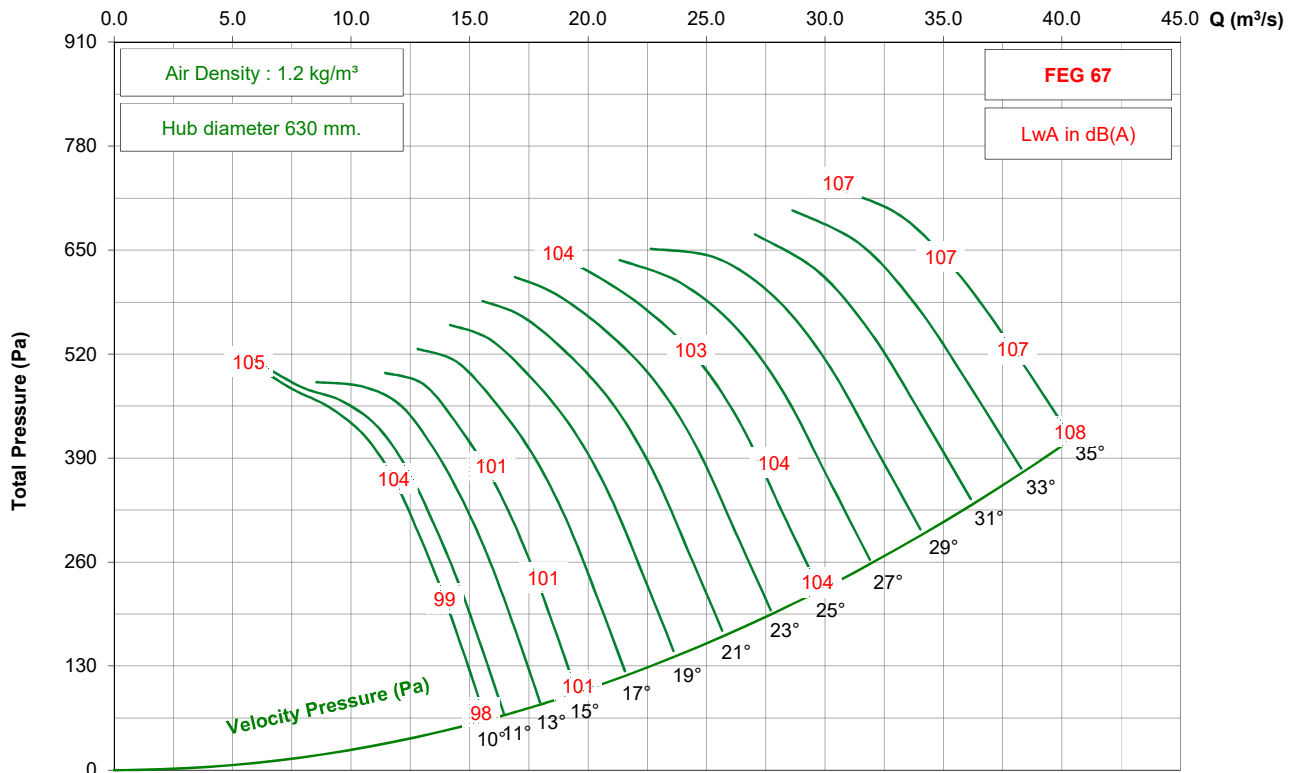

0 5 10 15 20 25 Vout (m/s)

- Performance certified is for installation type D - ducted inlet, ducted outlet. Performance ratings do not include the effects of appurtenances (accessories).
 - The A-weighted sound ratings shown have been calculated per AMCA International Standard 301. Values shown are for inlet Lwi(A) sound power levels for installation type D - ducted inlet, ducted outlet. Ratings include the effects of duct end correction.

KTF1400 / RB25 / H / 12-7V (Reverse)

725 rpm - 50 Hz

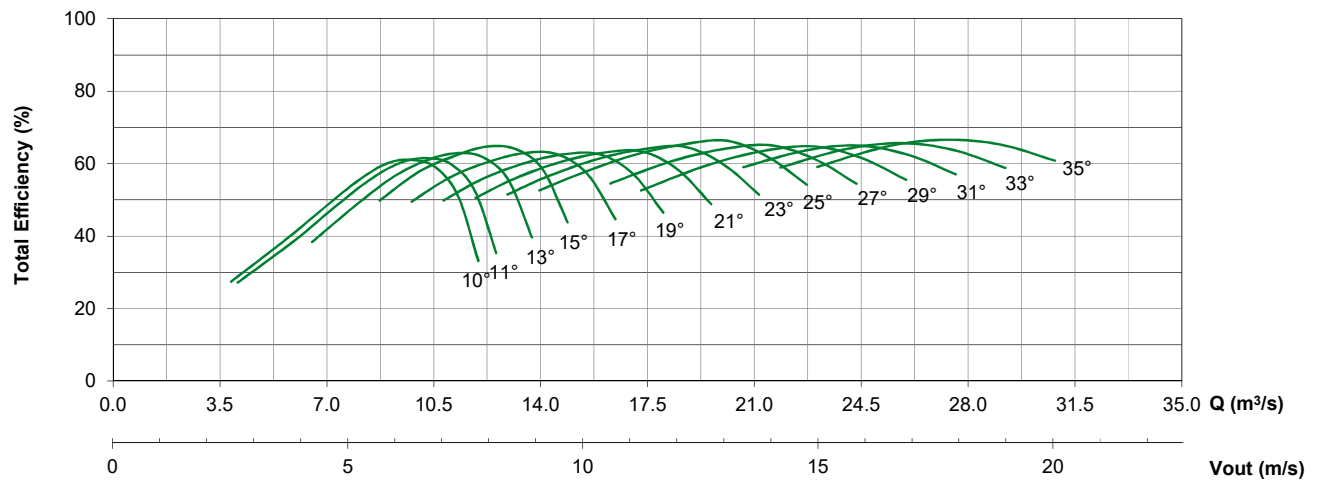
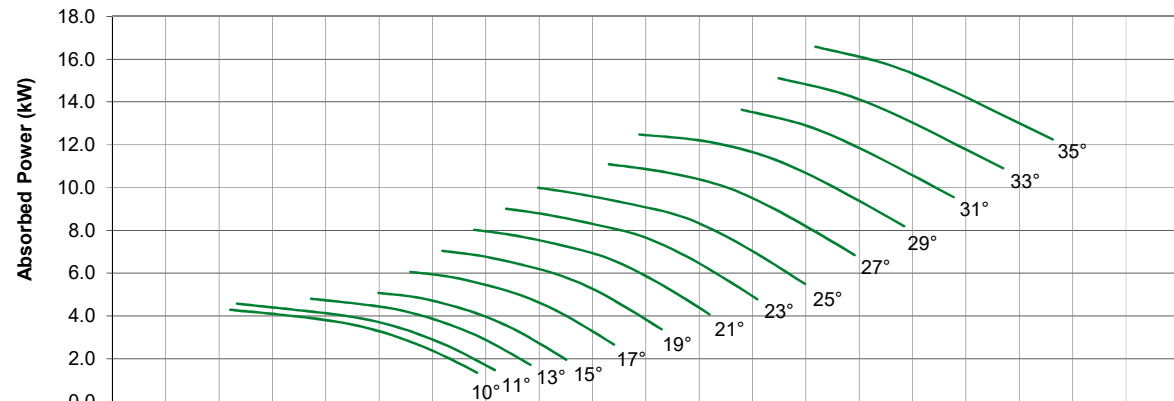
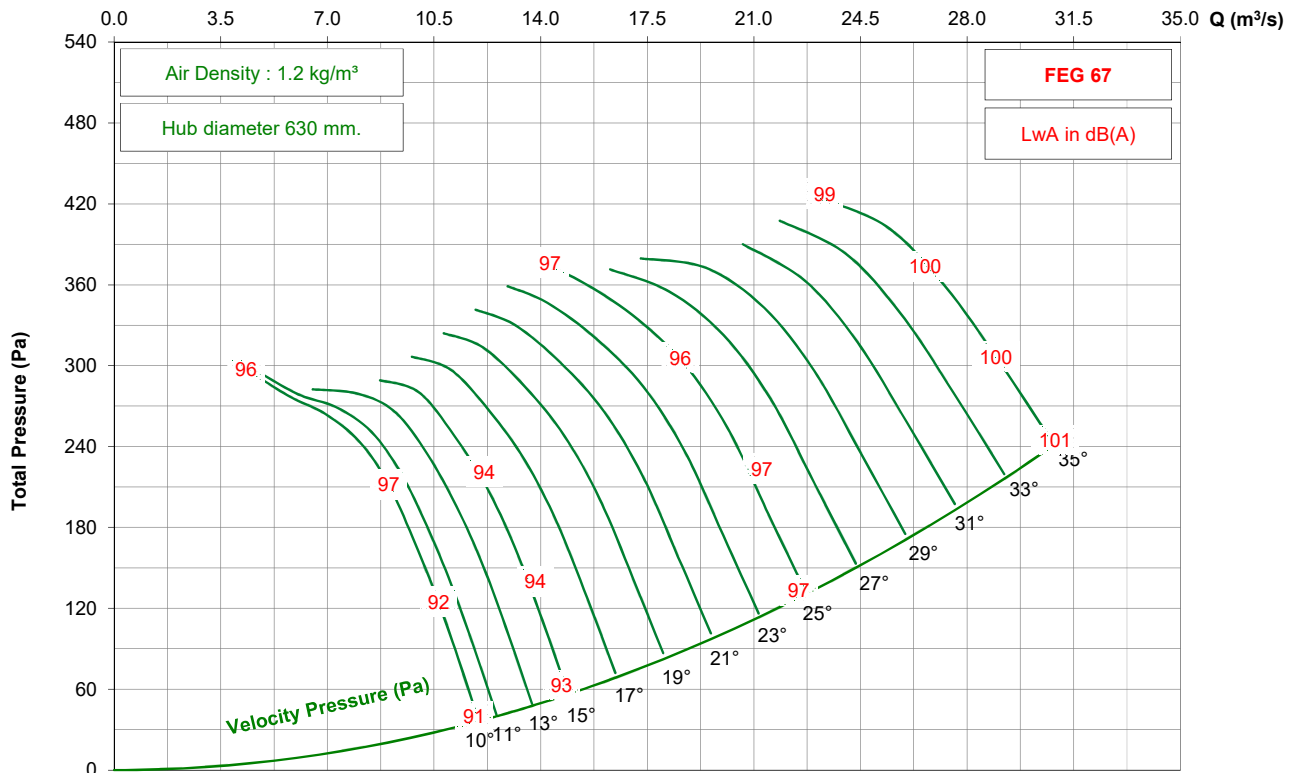

- Performance certified is for installation type D - ducted inlet, ducted outlet. Performance ratings do not include the effects of appurtenances (accessories).

- The A-weighted sound ratings shown have been calculated per AMCA International Standard 301. Values shown are for inlet Lwi(A) sound power levels for installation type D - ducted inlet, ducted outlet. Ratings include the effects of duct end correction.

KTF1400 / RB25 / H / 12-7V (Reverse)

1150 rpm - 60 Hz

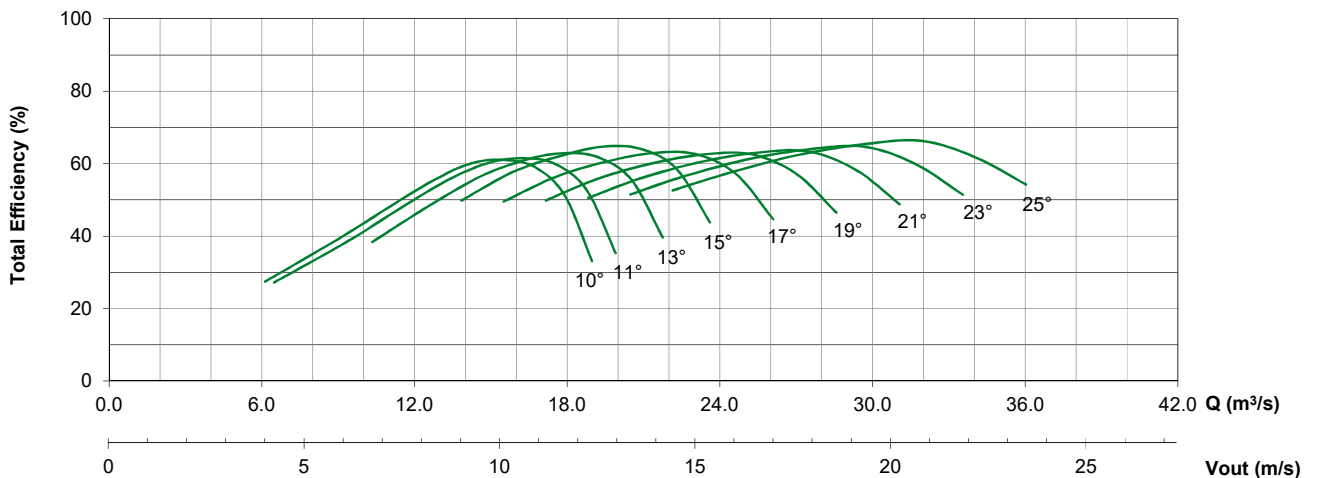
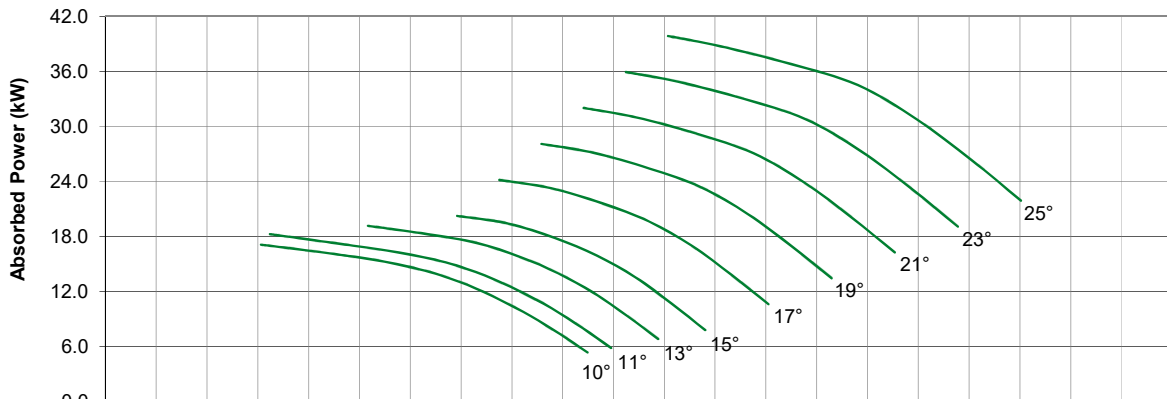
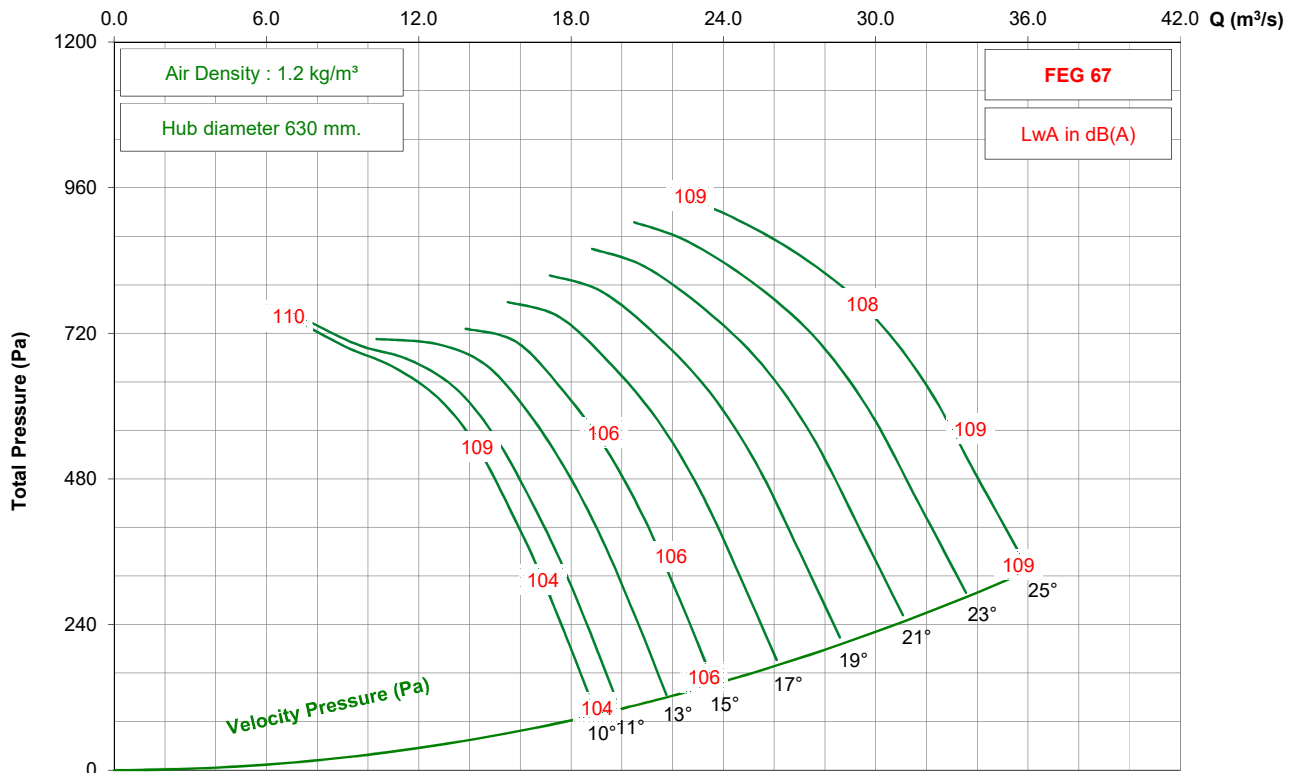

- Performance certified is for installation type D - ducted inlet, ducted outlet. Performance ratings do not include the effects of appurtenances (accessories).
 - The A-weighted sound ratings shown have been calculated per AMCA International Standard 301. Values shown are for inlet Lwi(A) sound power levels for installation type D - ducted inlet, ducted outlet. Ratings include the effects of duct end correction.

KTF1400 / RB25 / H / 12-7V (Reverse)

875 rpm - 60 Hz

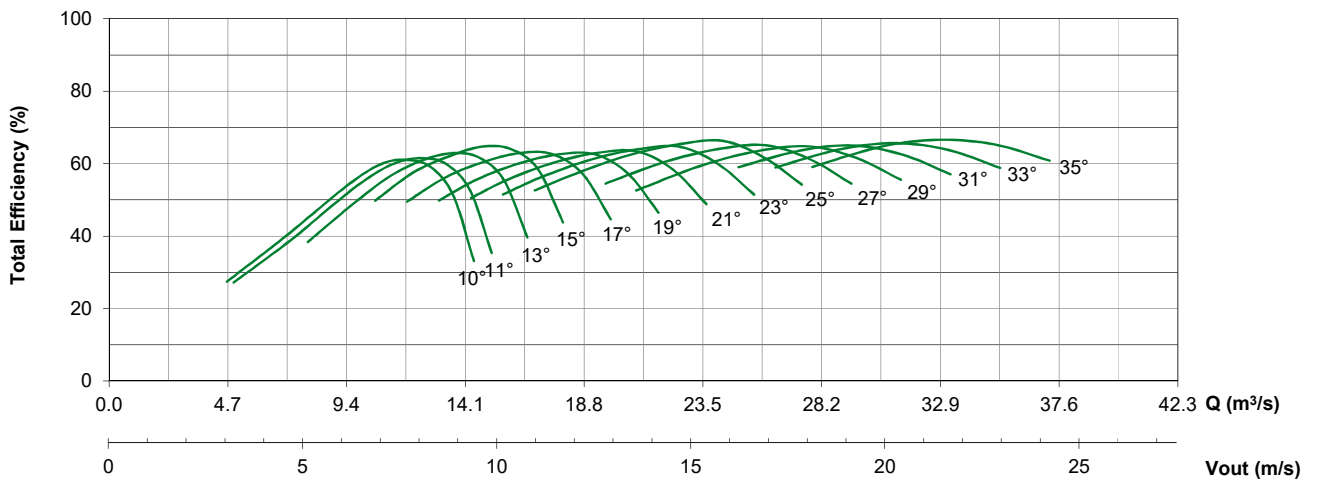
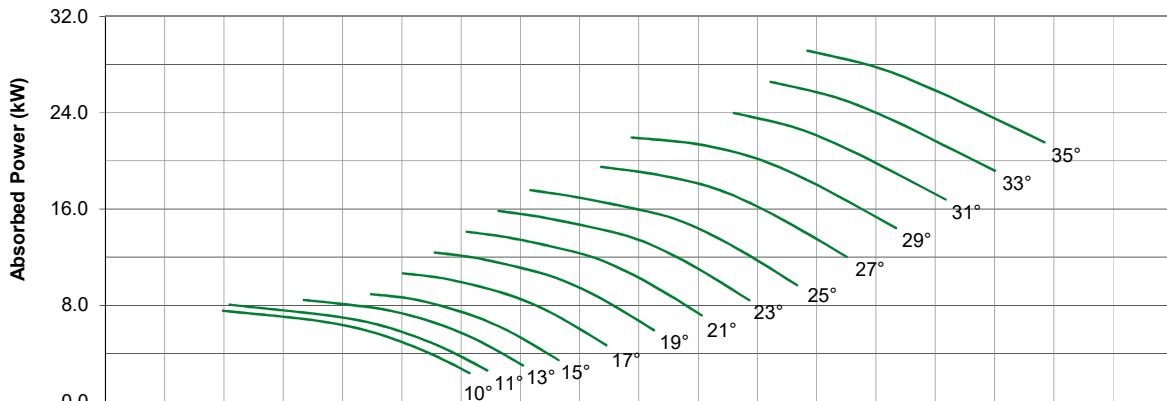
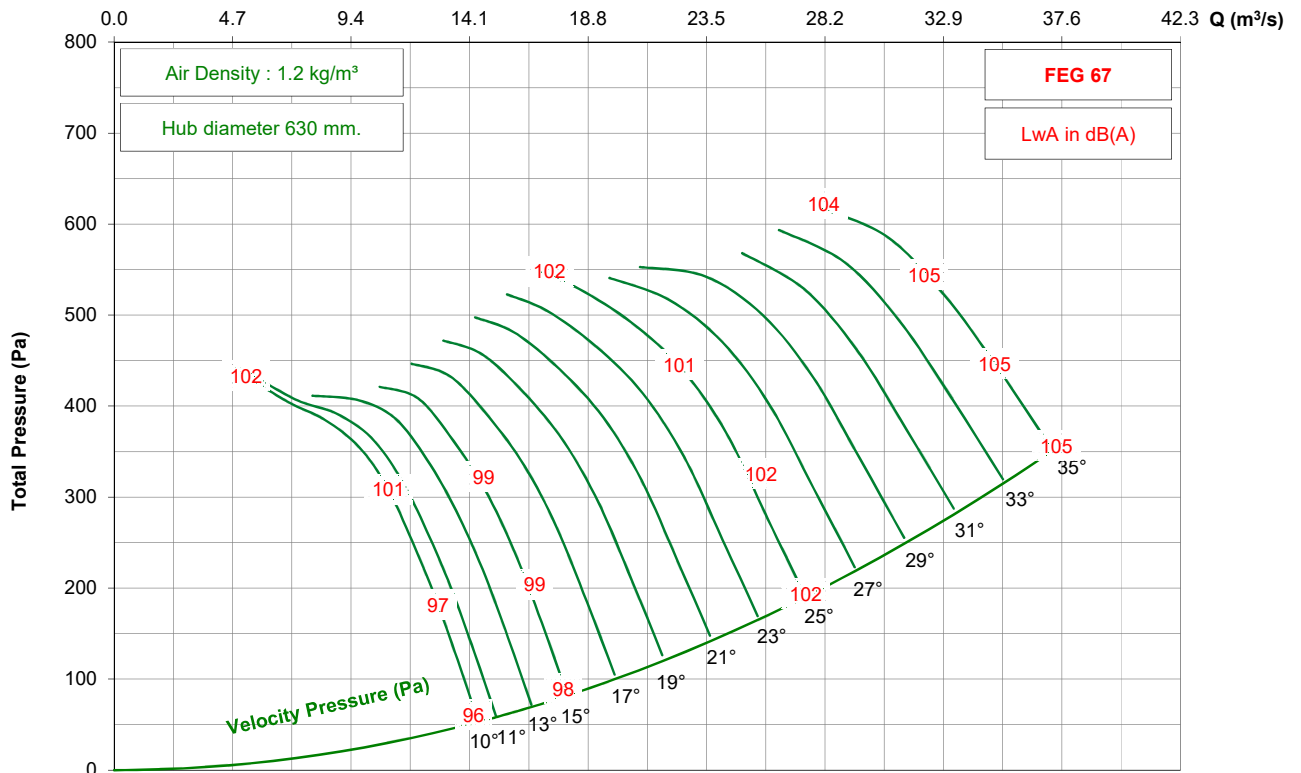

- Performance certified is for installation type D - ducted inlet, ducted outlet. Performance ratings do not include the effects of appurtenances (accessories).
 - The A-weighted sound ratings shown have been calculated per AMCA International Standard 301. Values shown are for inlet Lwi(A) sound power levels for installation type D - ducted inlet, ducted outlet. Ratings include the effects of duct end correction.

KTF1600 / RB28 / H / 12-7V (Forward)

950 rpm - 50 Hz

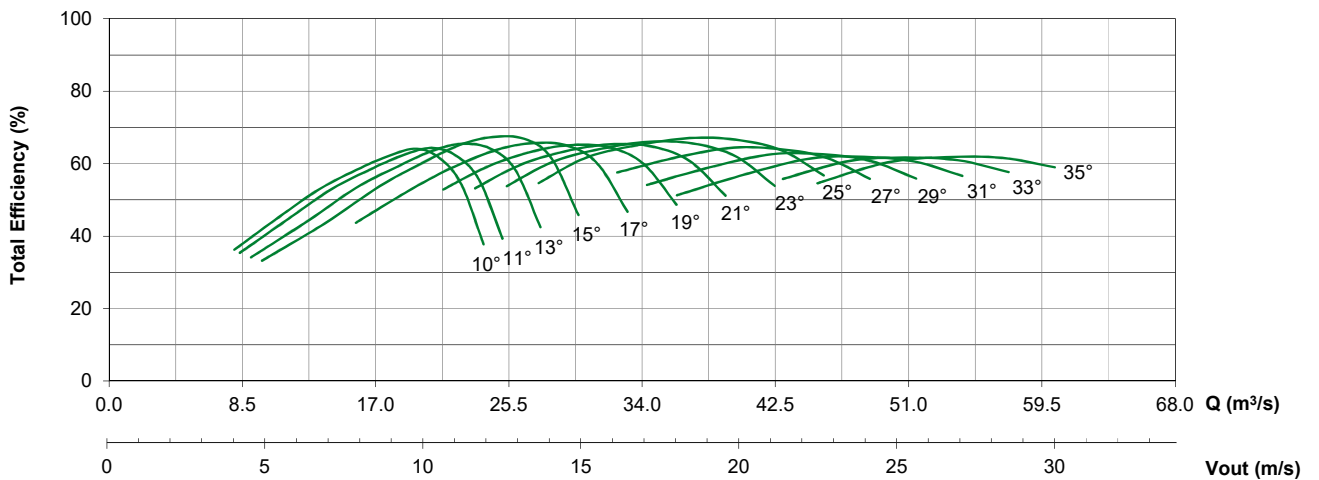
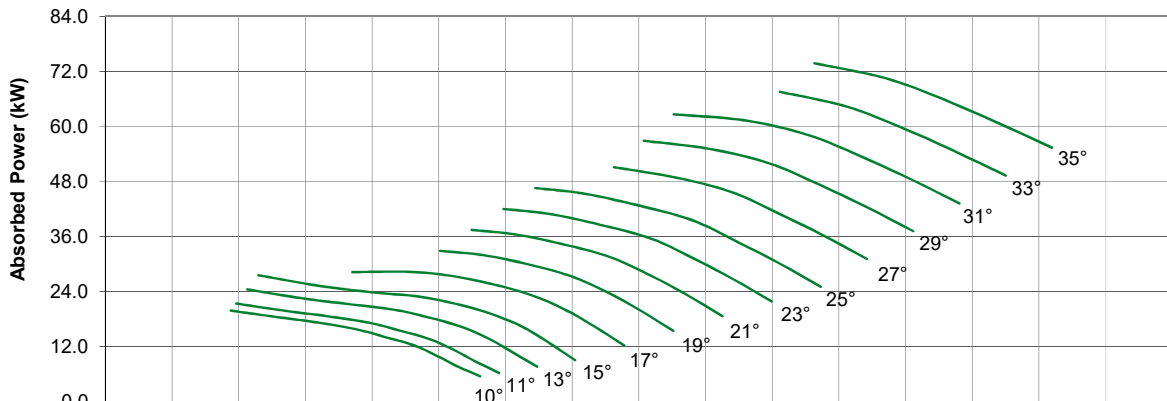
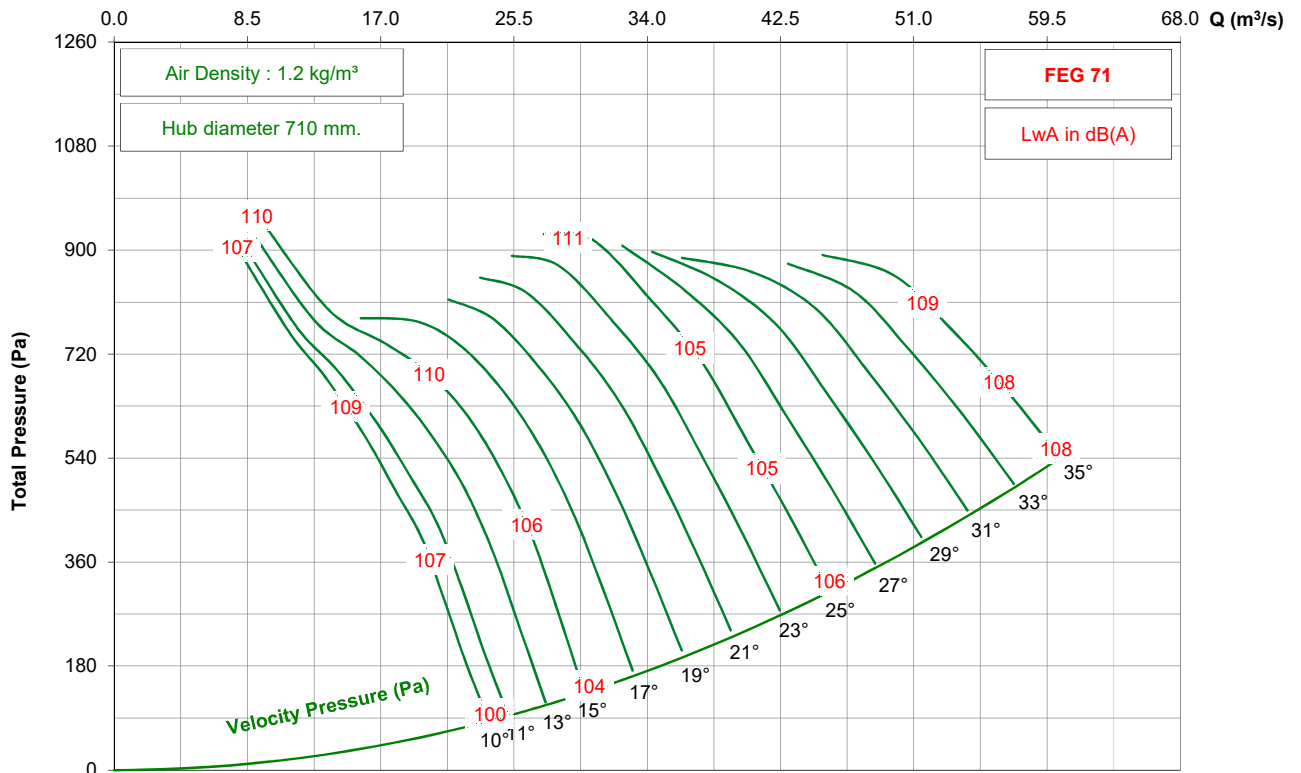

- Performance certified is for installation type D - ducted inlet, ducted outlet. Performance ratings do not include the effects of appurtenances (accessories).
 - The A-weighted sound ratings shown have been calculated per AMCA International Standard 301. Values shown are for inlet Lwi(A) sound power levels for installation type D - ducted inlet, ducted outlet. Ratings include the effects of duct end correction.

KTF1600 / RB28 / H / 12-7V (Forward)

725 rpm - 50 Hz

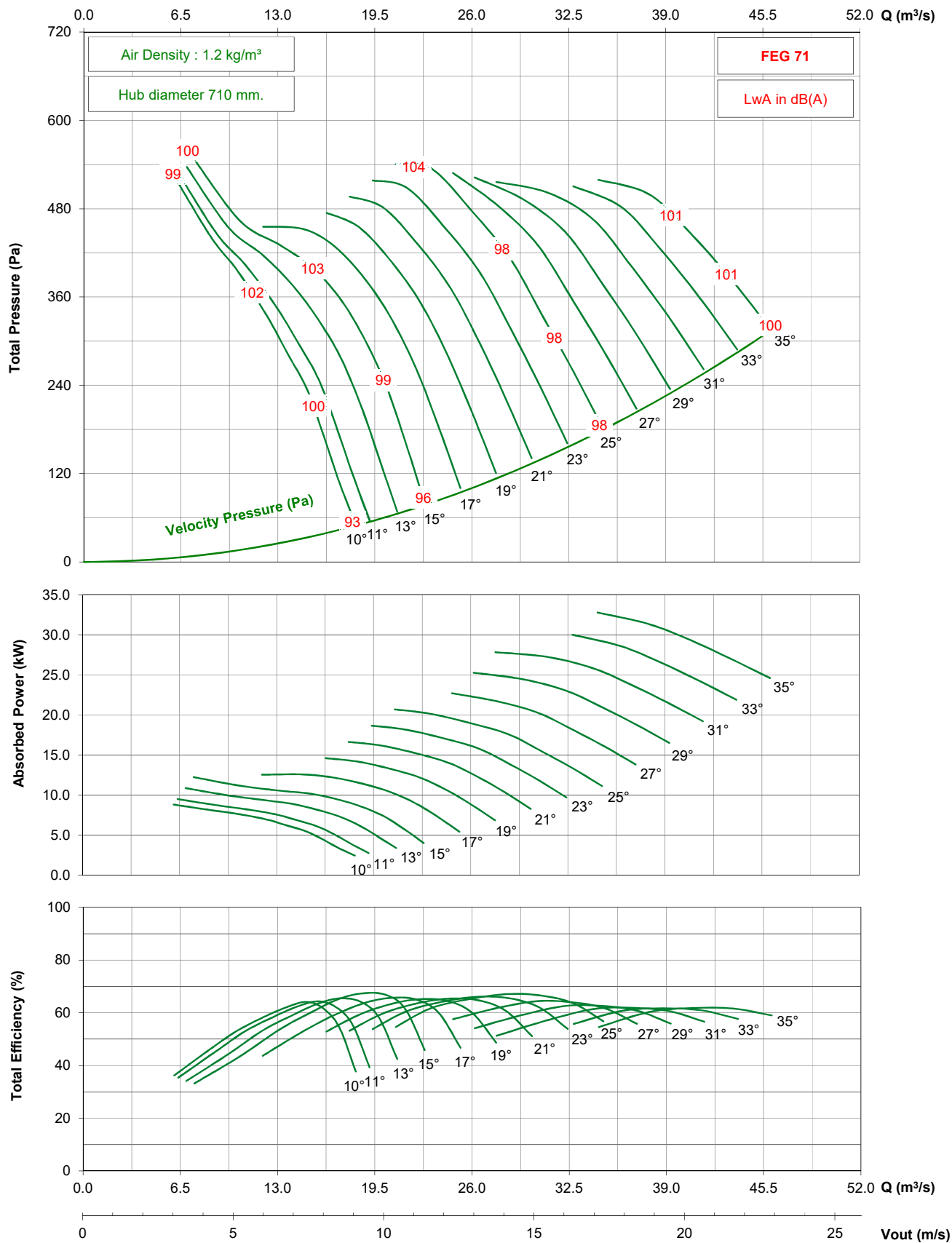

- Performance certified is for installation type D - ducted inlet, ducted outlet. Performance ratings do not include the effects of appurtenances (accessories).
 - The A-weighted sound ratings shown have been calculated per AMCA International Standard 301. Values shown are for inlet Lwi(A) sound power levels for installation type D - ducted inlet, ducted outlet. Ratings include the effects of duct end correction.

KTF1600 / RB28 / H / 12-7V (Forward)

1150 rpm - 60 Hz

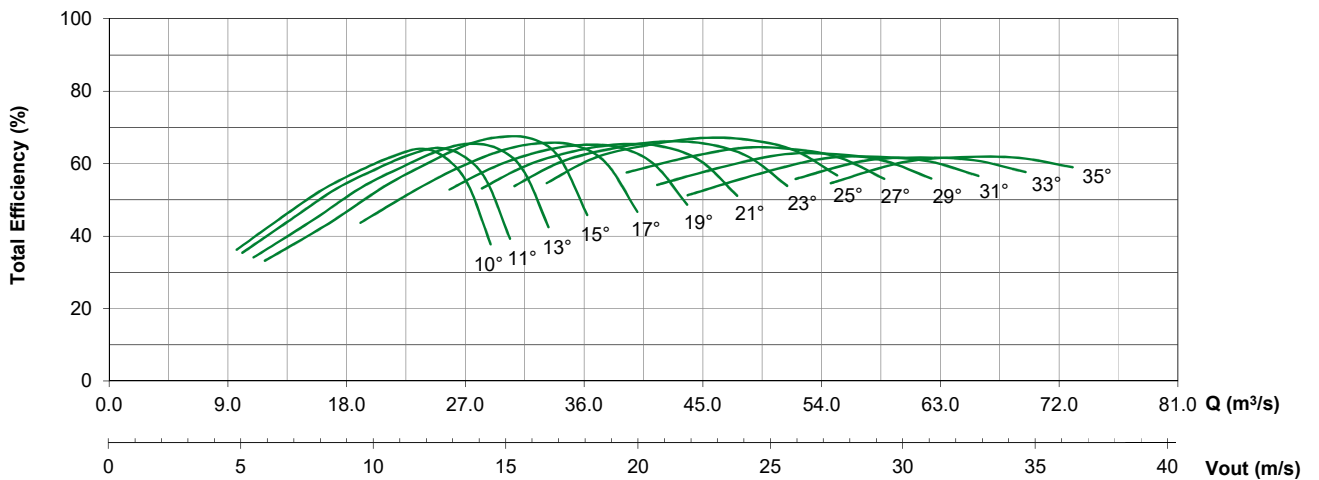
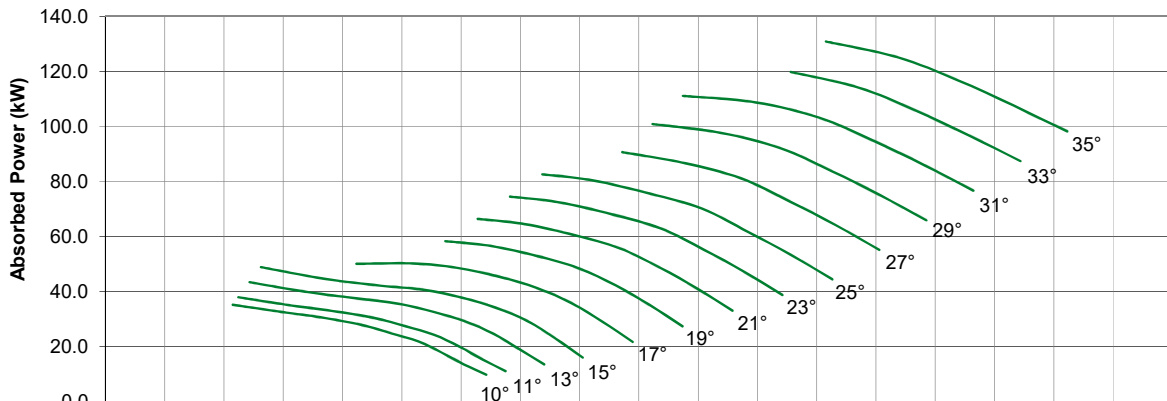
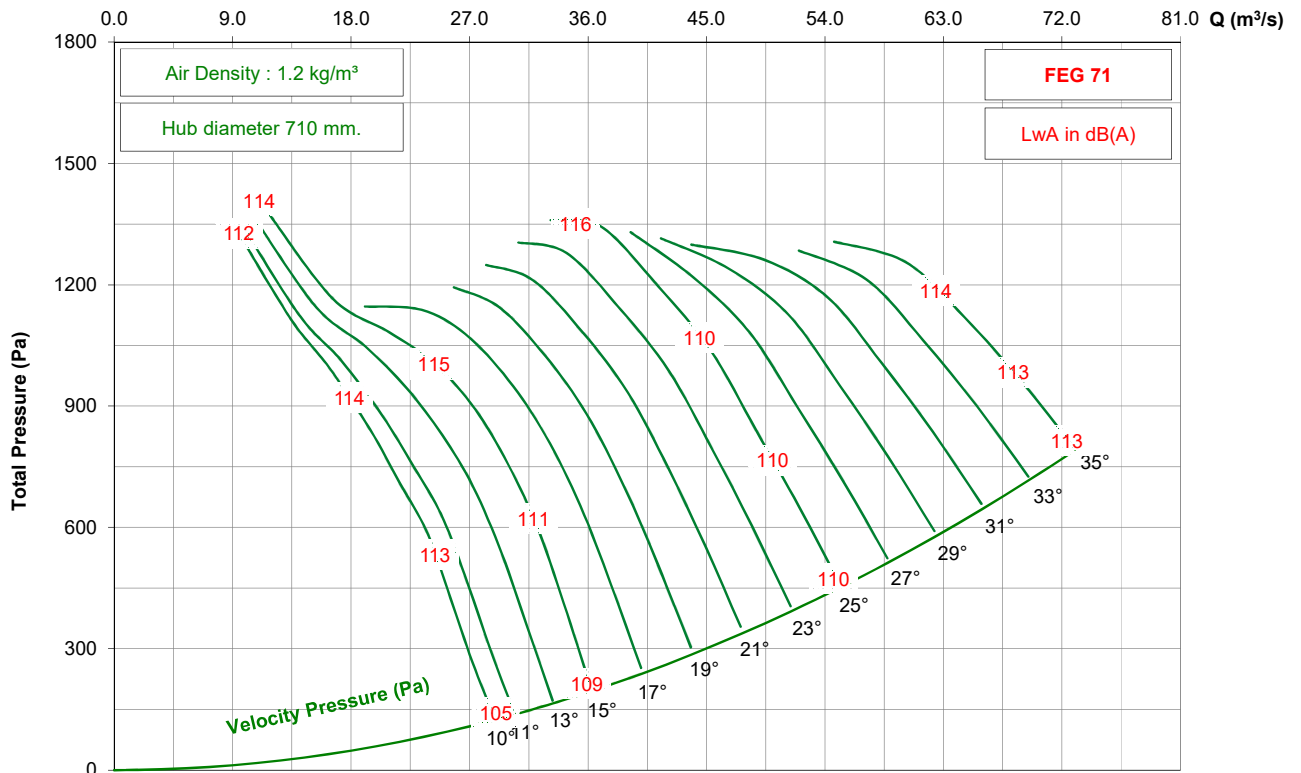

- Performance certified is for installation type D - ducted inlet, ducted outlet. Performance ratings do not include the effects of appurtenances (accessories).

- The A-weighted sound ratings shown have been calculated per AMCA International Standard 301. Values shown are for inlet Lwi(A) sound power levels for installation type D - ducted inlet, ducted outlet. Ratings include the effects of duct end correction.

KTF1600 / RB28 / H / 12-7V (Forward)

875 rpm - 60 Hz

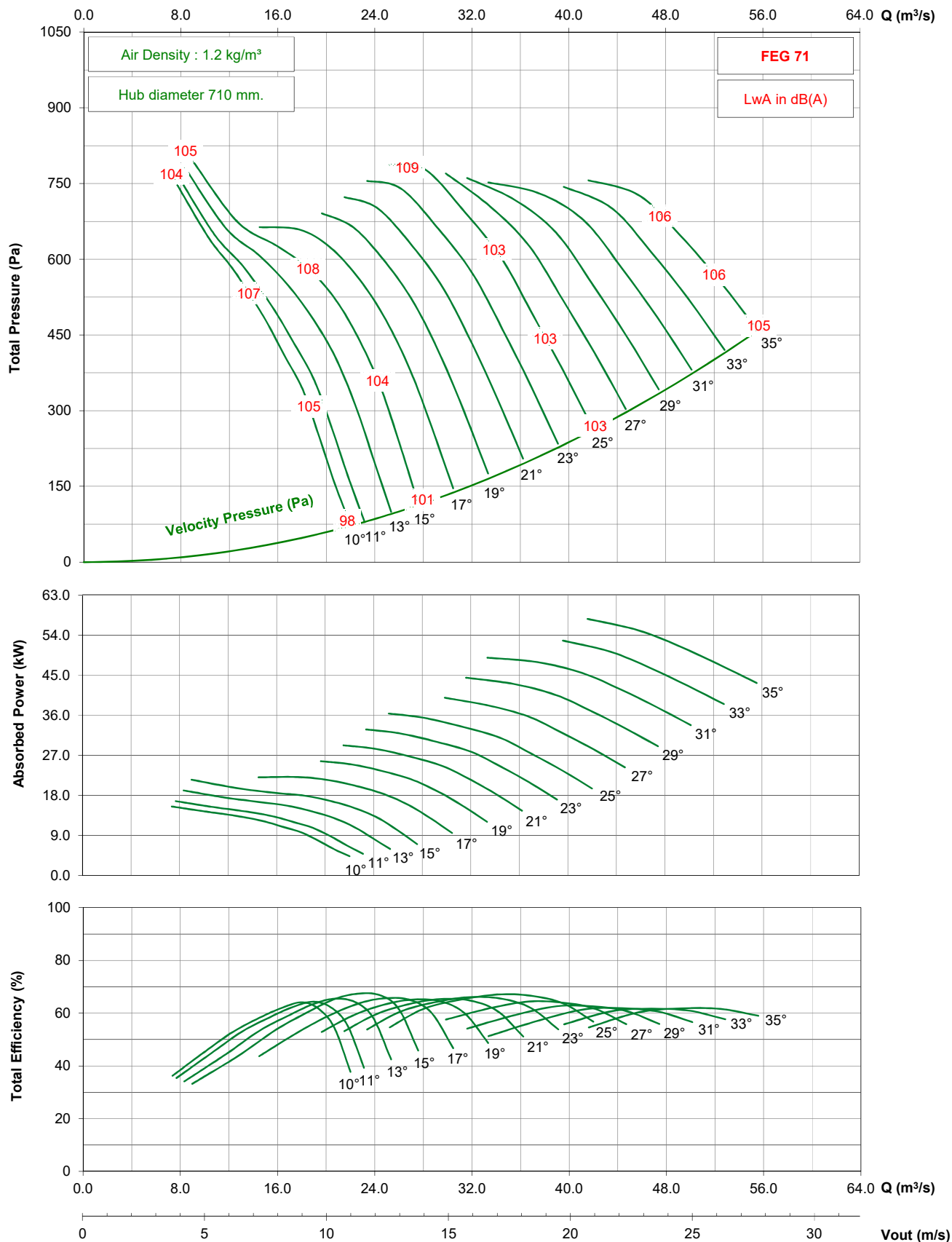

- Performance certified is for installation type D - ducted inlet, ducted outlet. Performance ratings do not include the effects of appurtenances (accessories).
 - The A-weighted sound ratings shown have been calculated per AMCA International Standard 301. Values shown are for inlet Lwi(A) sound power levels for installation type D - ducted inlet, ducted outlet. Ratings include the effects of duct end correction.

KTF1600 / RB28 / H / 12-7V (Reverse)

950 rpm - 50 Hz

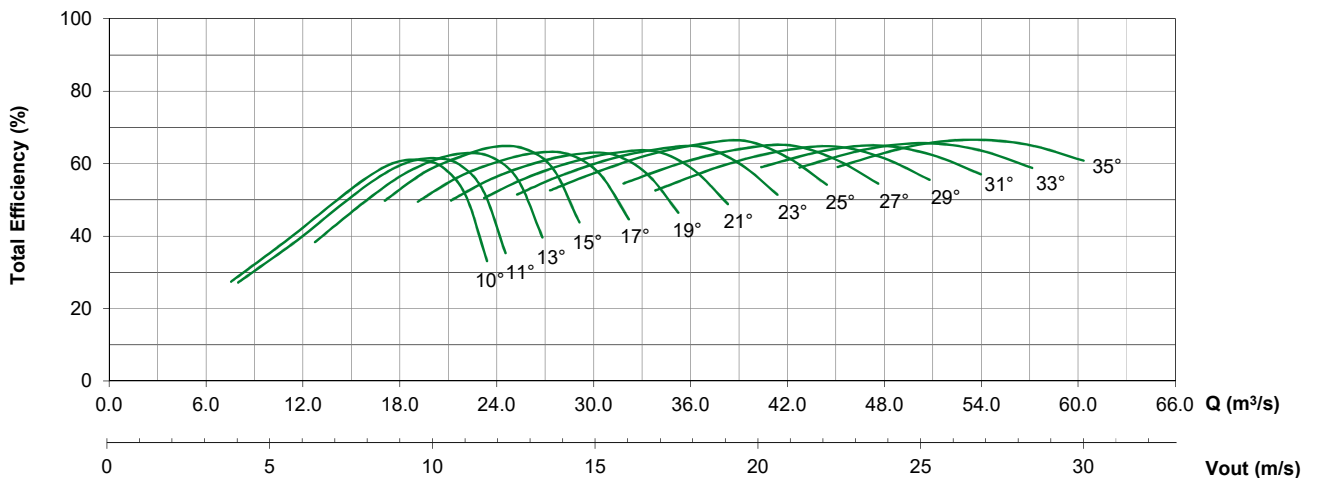
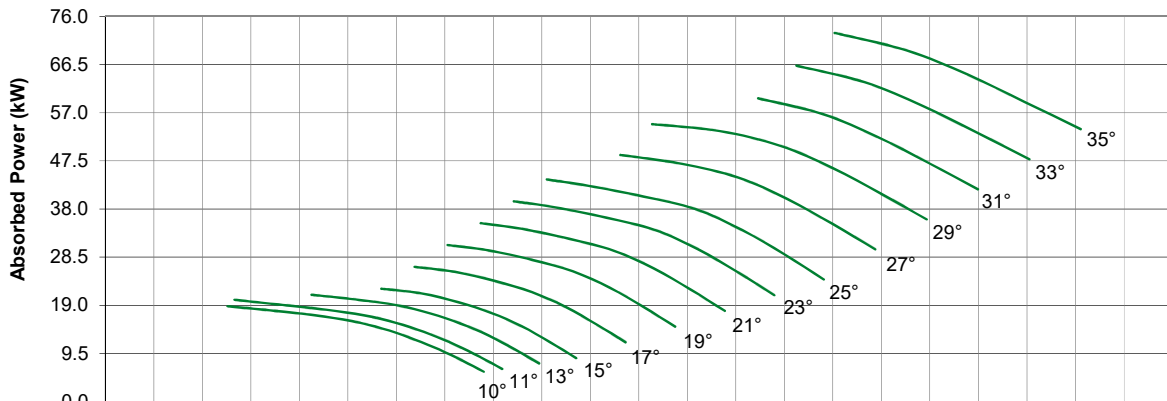
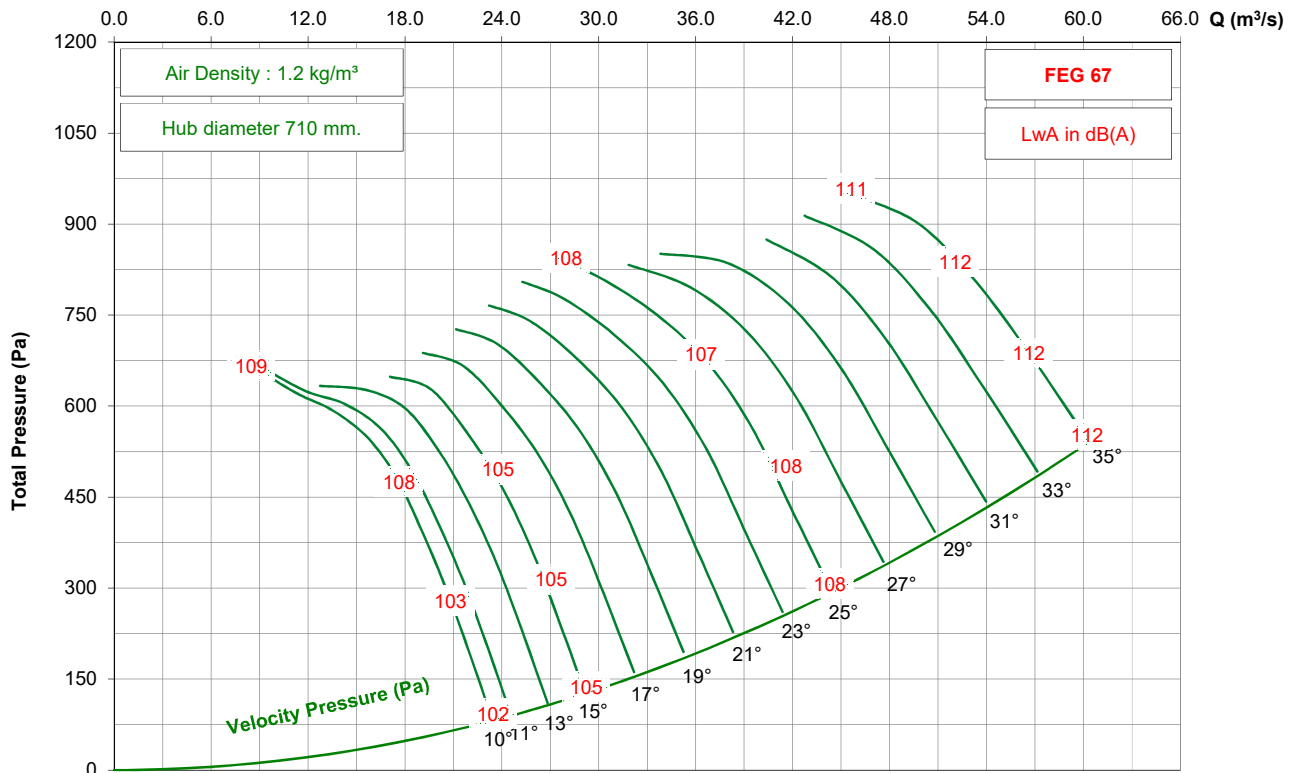

- Performance certified is for installation type D - ducted inlet, ducted outlet. Performance ratings do not include the effects of appurtenances (accessories).
 - The A-weighted sound ratings shown have been calculated per AMCA International Standard 301. Values shown are for inlet Lwi(A) sound power levels for installation type D - ducted inlet, ducted outlet. Ratings include the effects of duct end correction.

KTF1600 / RB28 / H / 12-7V (Reverse)

725 rpm - 50 Hz

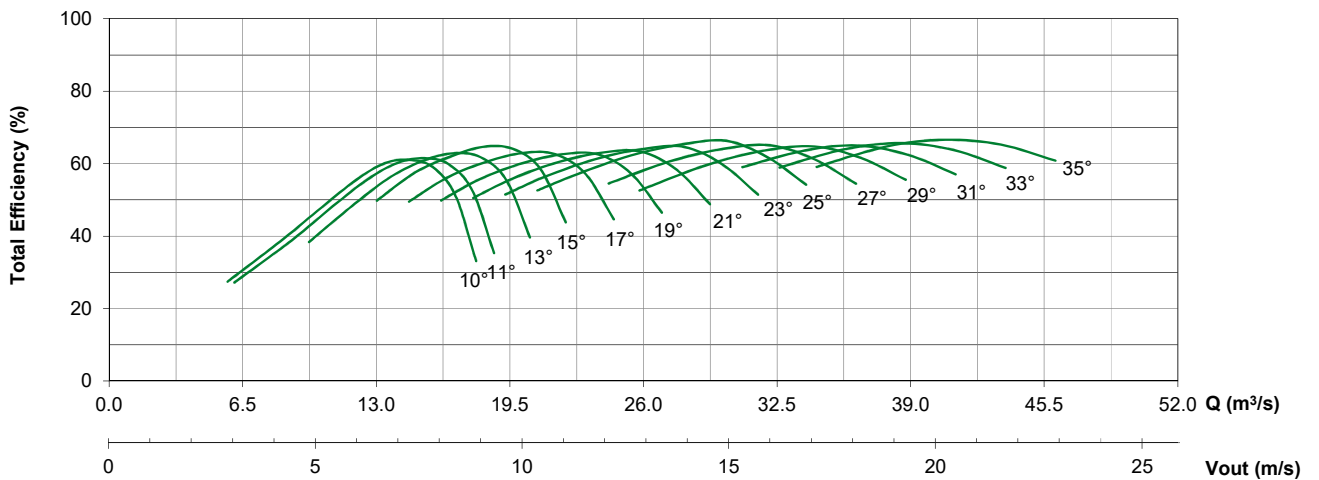
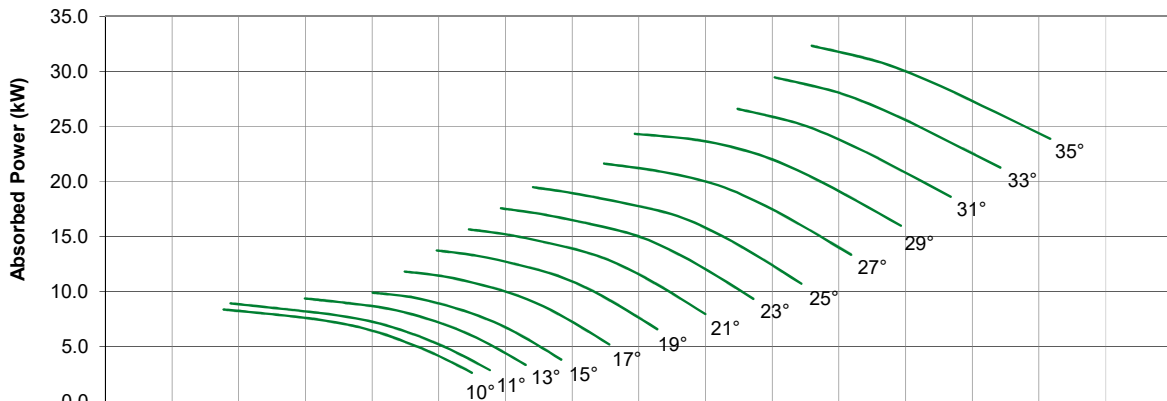
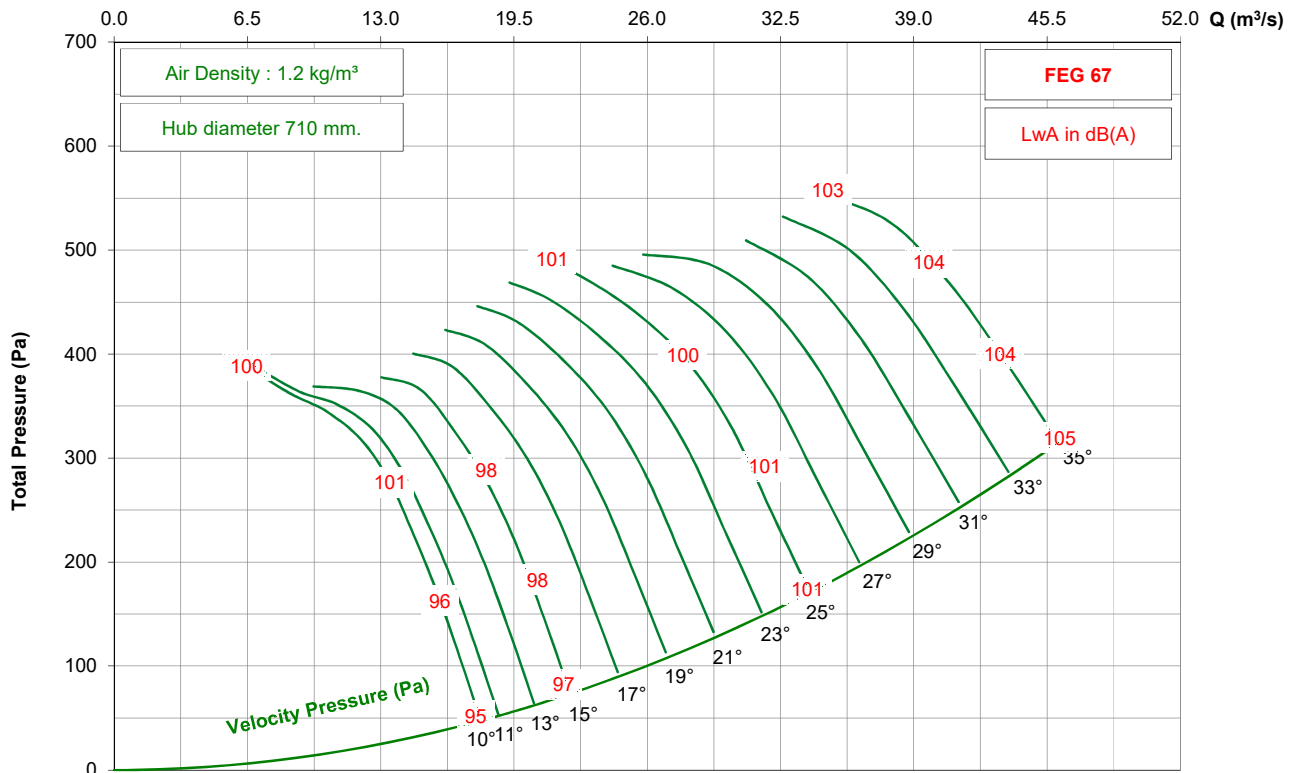

- Performance certified is for installation type D - ducted inlet, ducted outlet. Performance ratings do not include the effects of appurtenances (accessories).

- The A-weighted sound ratings shown have been calculated per AMCA International Standard 301. Values shown are for inlet Lwi(A) sound power levels for installation type D - ducted inlet, ducted outlet. Ratings include the effects of duct end correction.

KTF1600 / RB28 / H / 12-7V (Reverse)

1150 rpm - 60 Hz

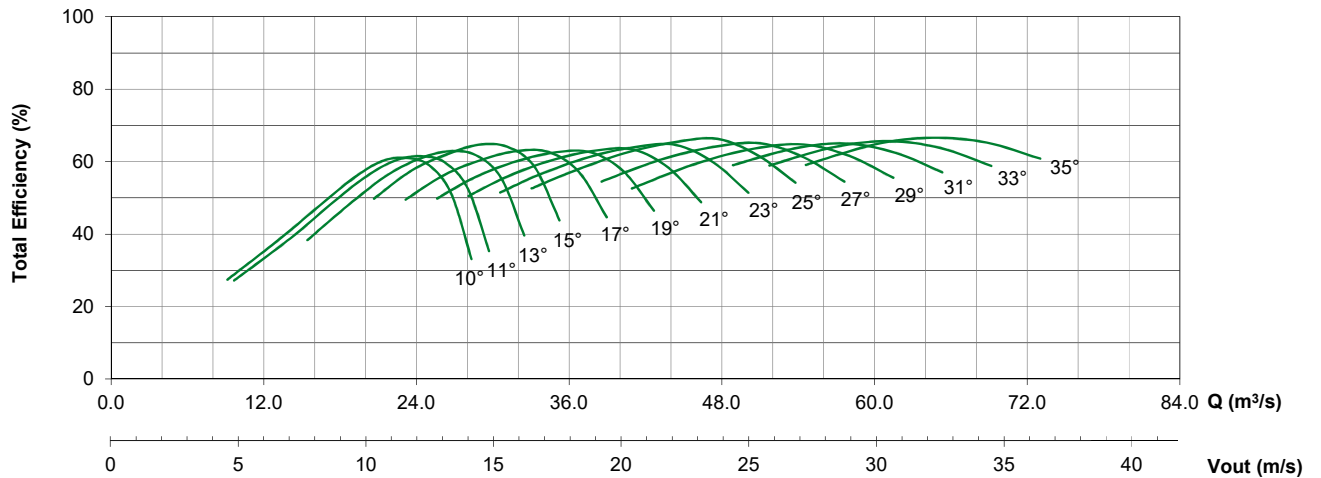
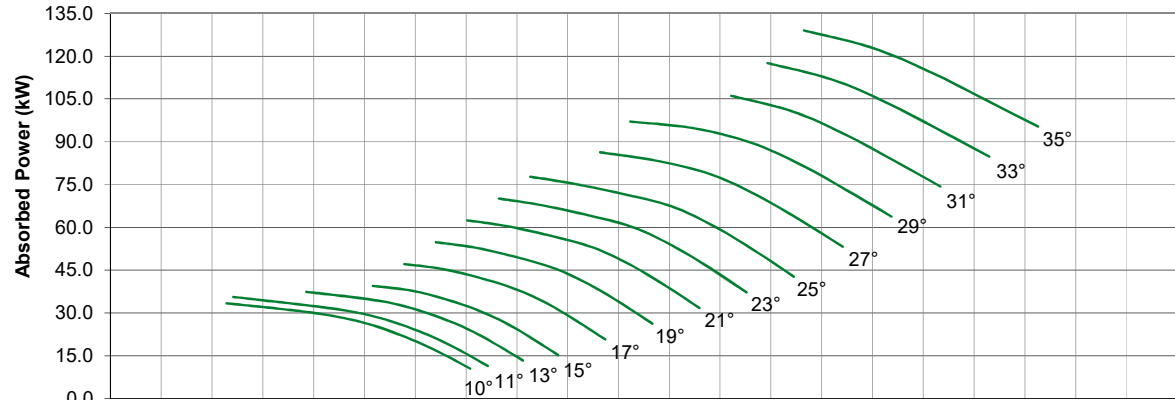
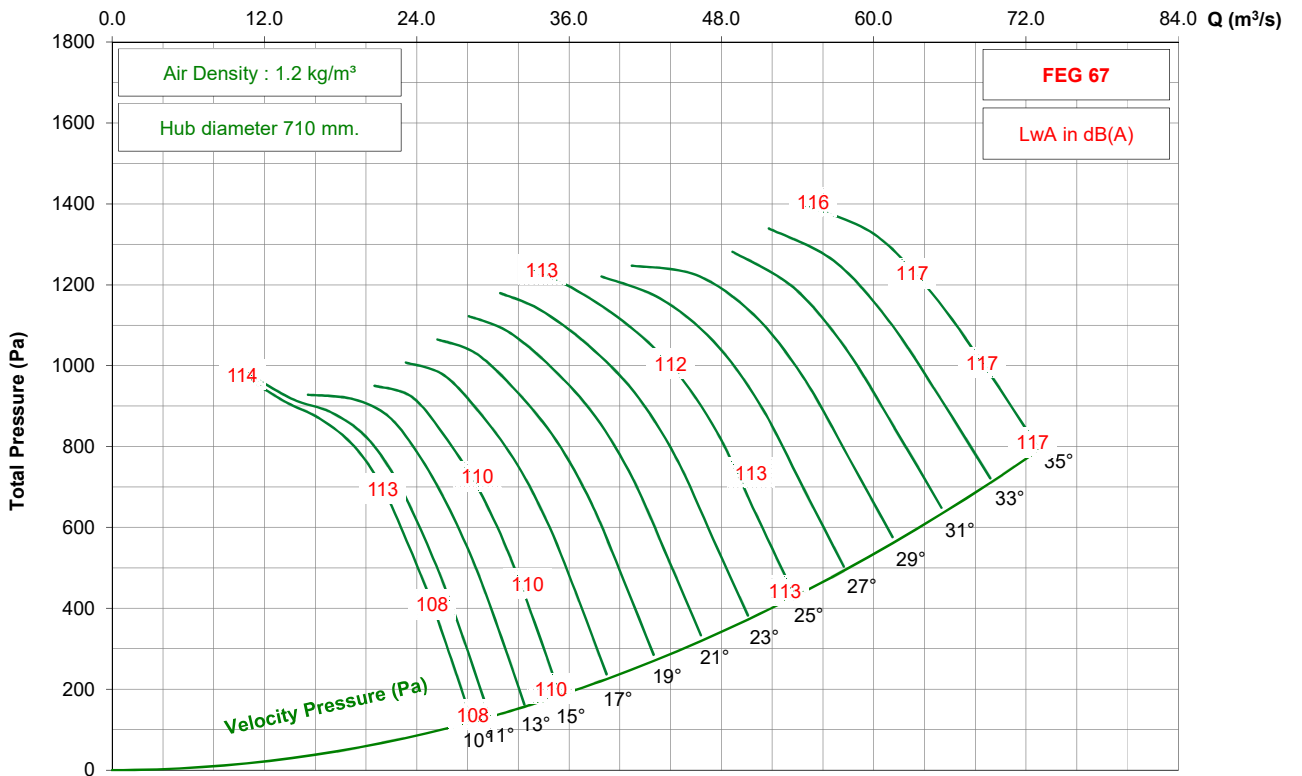

- Performance certified is for installation type D - ducted inlet, ducted outlet. Performance ratings do not include the effects of appurtenances (accessories).
 - The A-weighted sound ratings shown have been calculated per AMCA International Standard 301. Values shown are for inlet Lwi(A) sound power levels for installation type D - ducted inlet, ducted outlet. Ratings include the effects of duct end correction.

KTF1600 / RB28 / H / 12-7V (Reverse)

875 rpm - 60 Hz

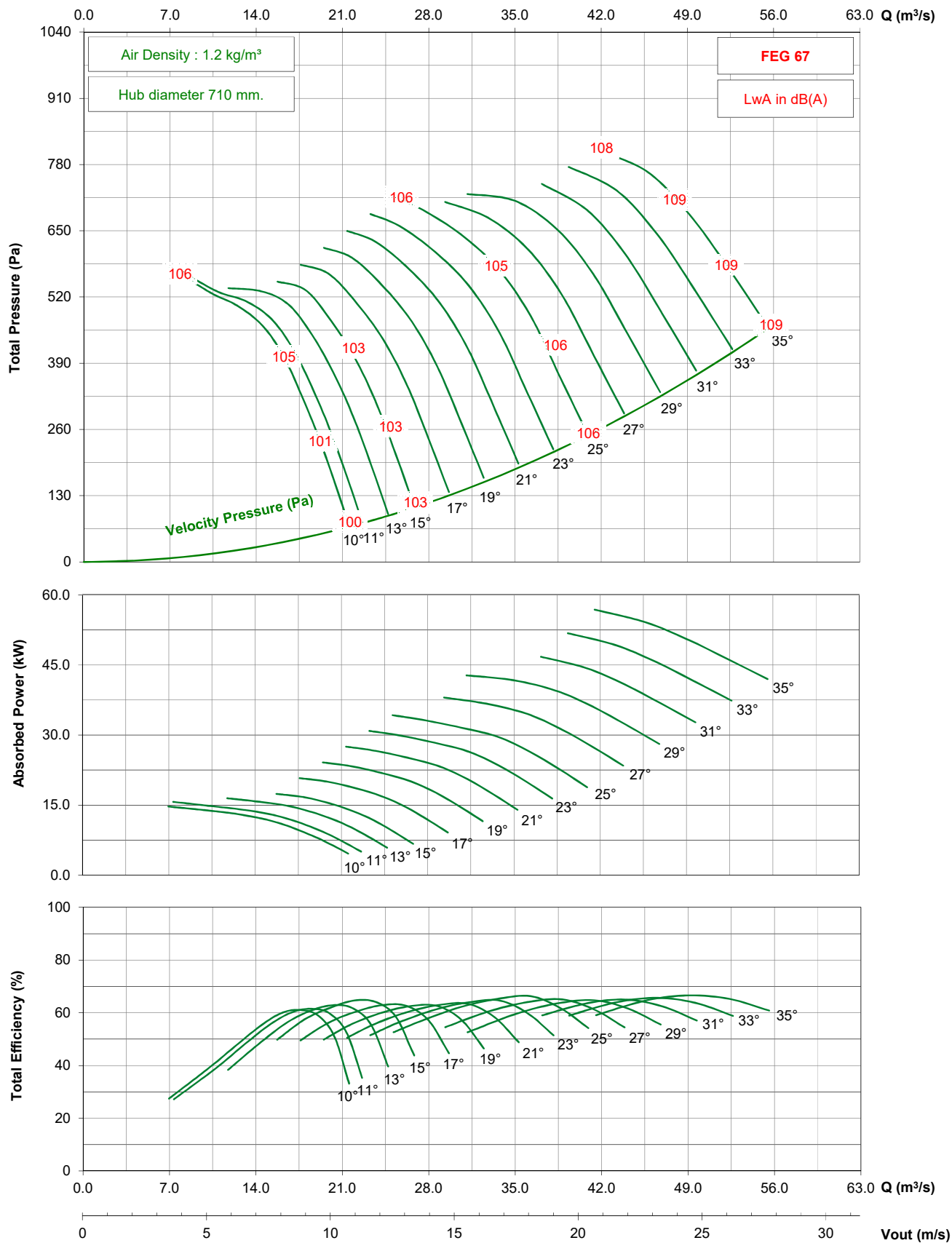

- Performance certified is for installation type D - ducted inlet, ducted outlet. Performance ratings do not include the effects of appurtenances (accessories).
 - The A-weighted sound ratings shown have been calculated per AMCA International Standard 301. Values shown are for inlet Lwi(A) sound power levels for installation type D - ducted inlet, ducted outlet. Ratings include the effects of duct end correction.

KTF1800 / RB31 / H / 12-7V (Forward)

950 rpm - 50 Hz

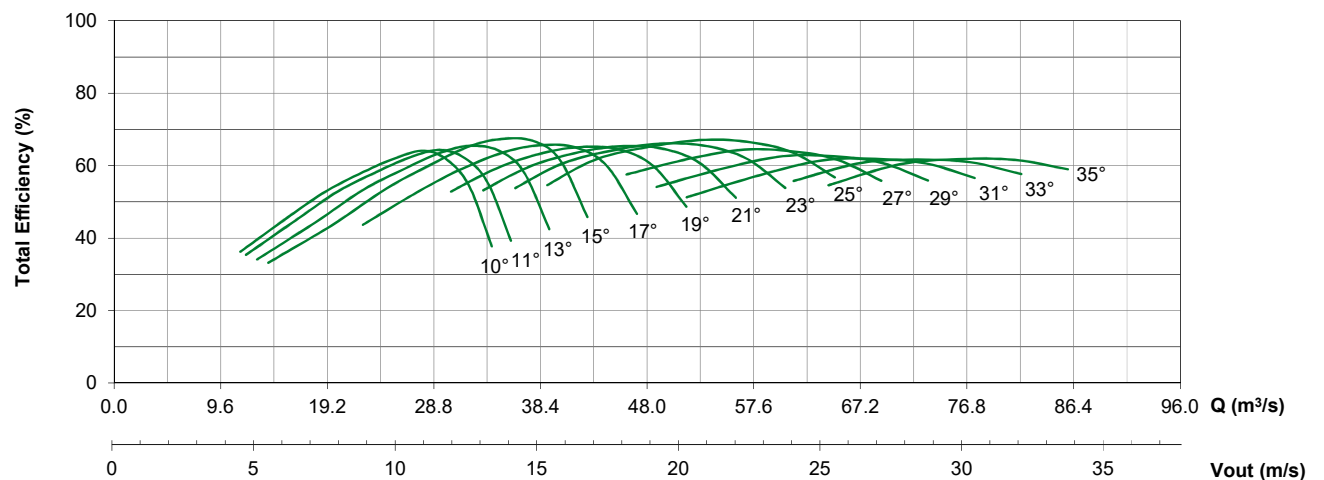
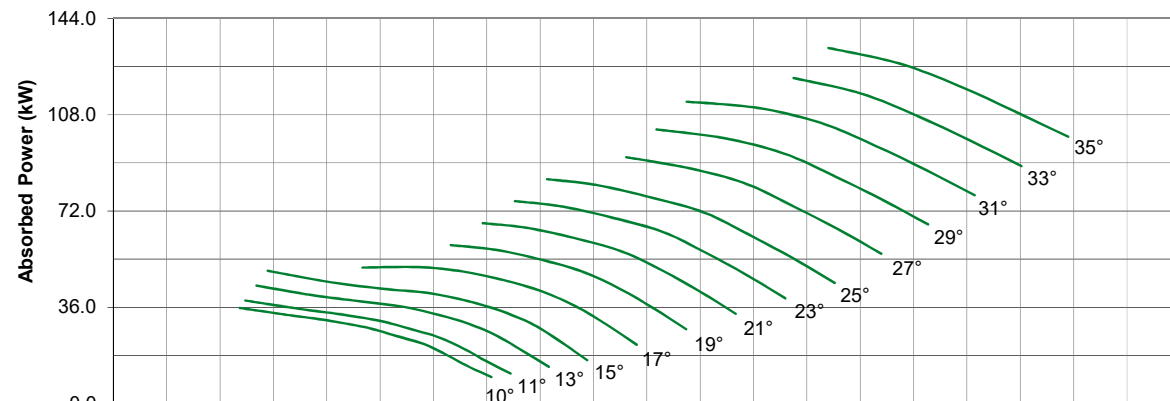
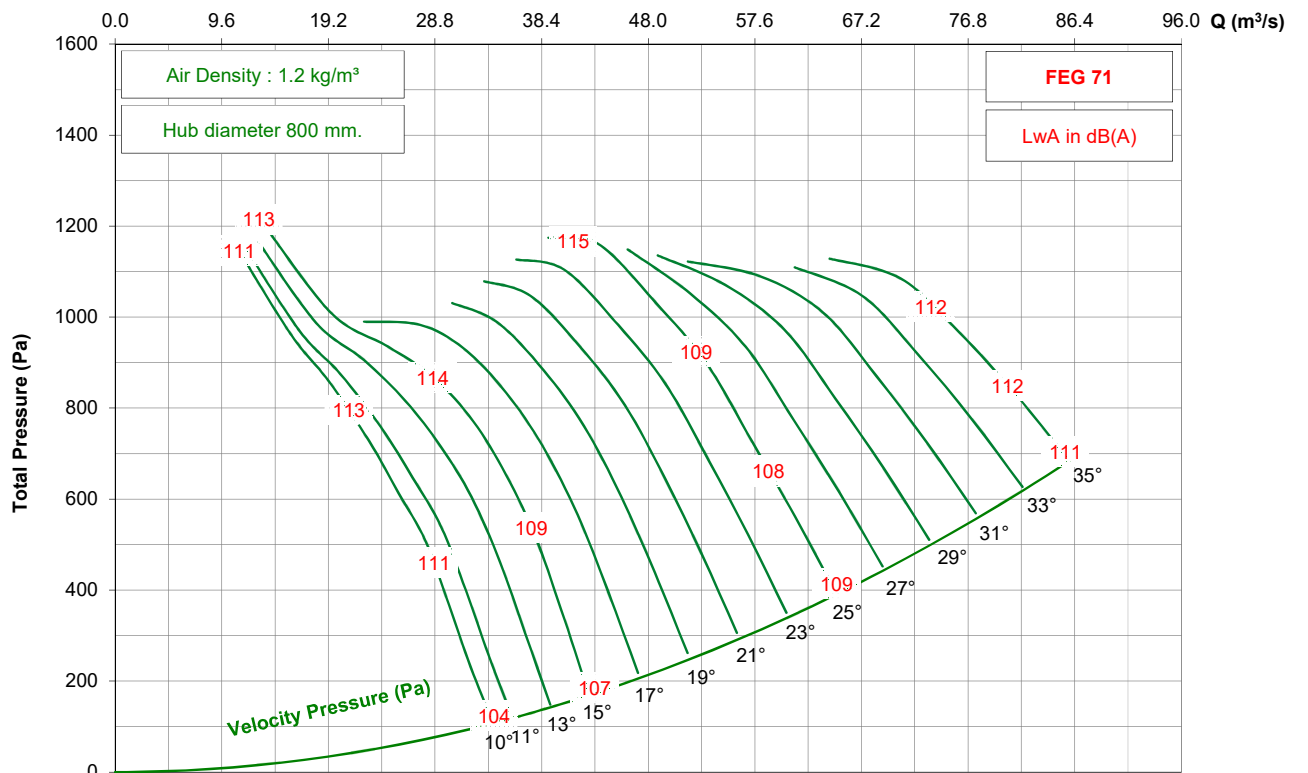

- Performance certified is for installation type D - ducted inlet, ducted outlet. Performance ratings do not include the effects of appurtenances (accessories).
 - The A-weighted sound ratings shown have been calculated per AMCA International Standard 301. Values shown are for inlet Lwi(A) sound power levels for installation type D - ducted inlet, ducted outlet. Ratings include the effects of duct end correction.

KTF1800 / RB31 / H / 12-7V (Forward)

725 rpm - 50 Hz

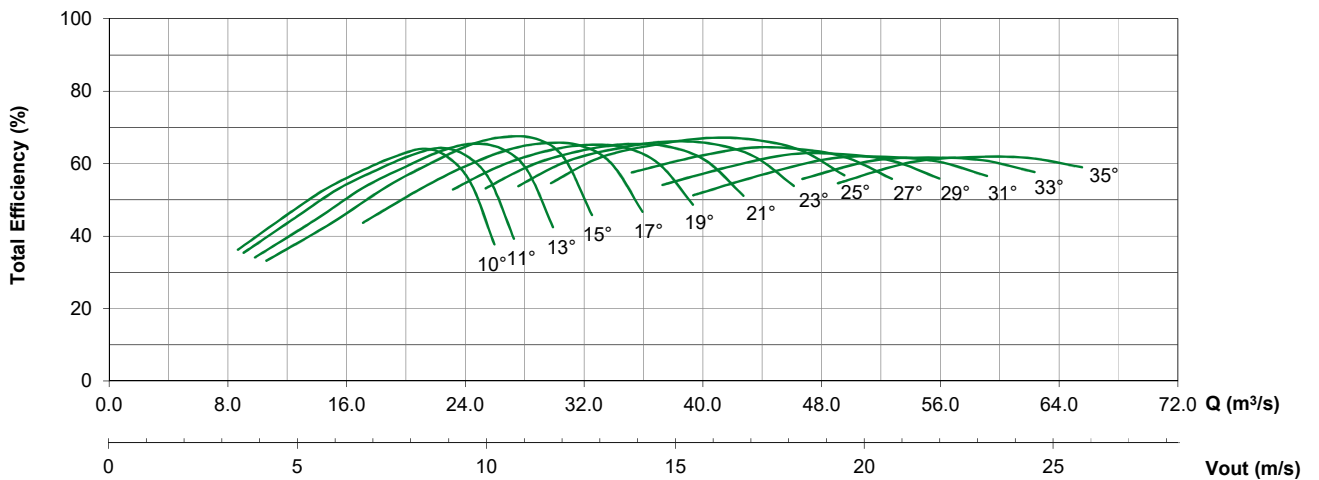
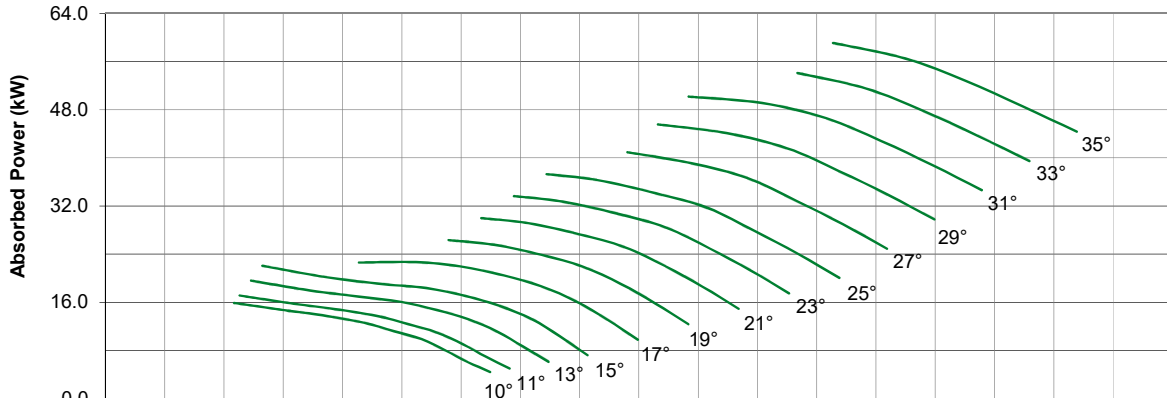
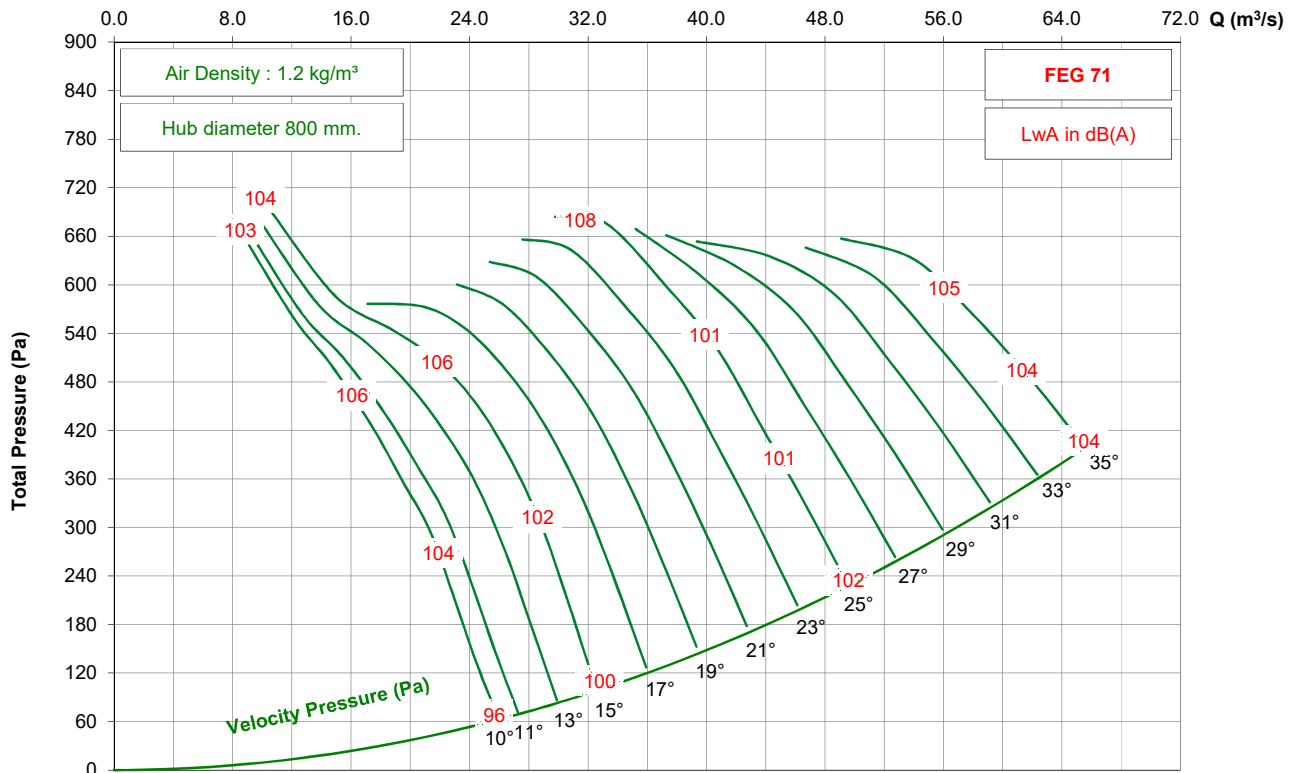

- Performance certified is for installation type D - ducted inlet, ducted outlet. Performance ratings do not include the effects of appurtenances (accessories).
 - The A-weighted sound ratings shown have been calculated per AMCA International Standard 301. Values shown are for inlet Lwi(A) sound power levels for installation type D - ducted inlet, ducted outlet. Ratings include the effects of duct end correction.

KTF1800 / RB31 / H / 12-7V (Forward)

1150 rpm - 60 Hz

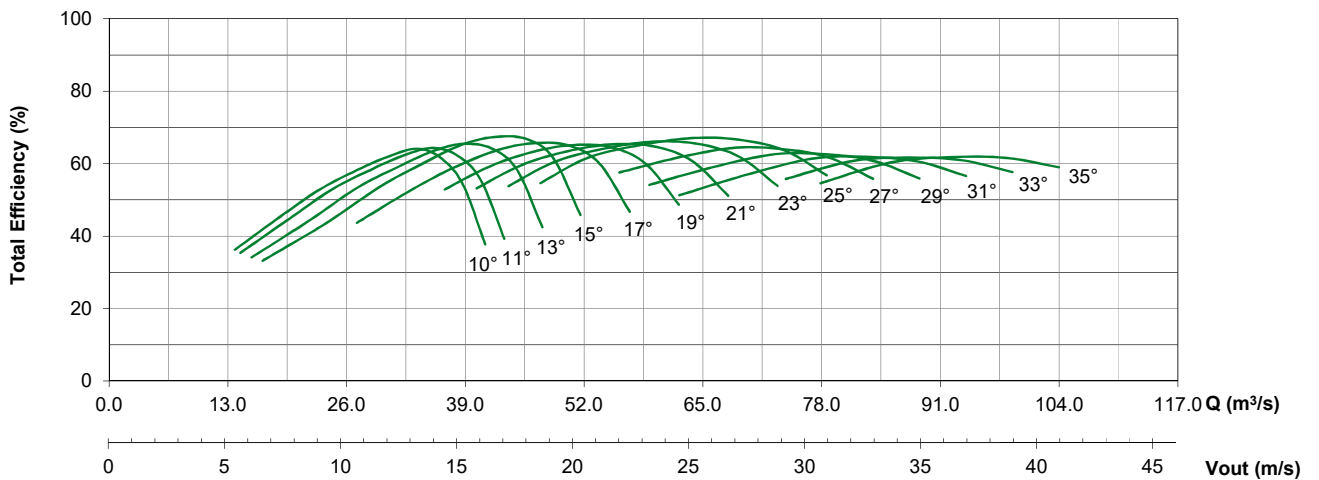
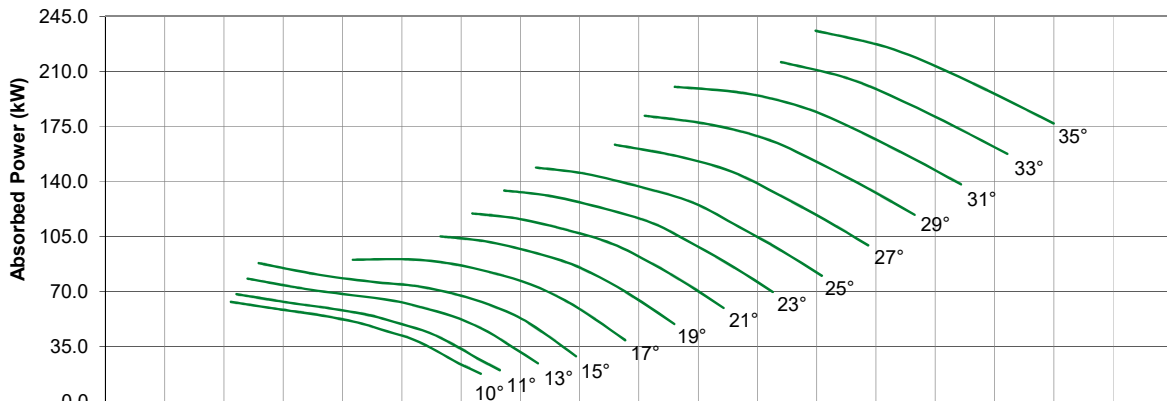
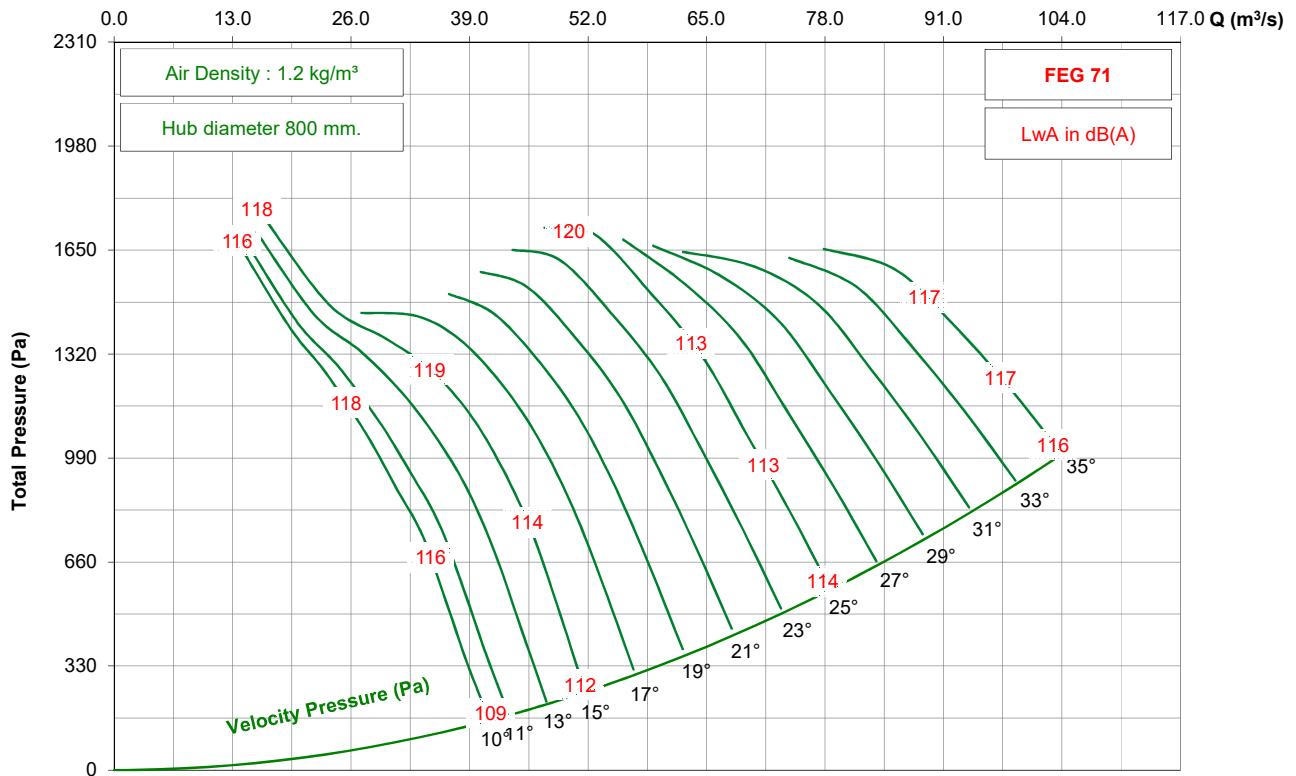

- Performance certified is for installation type D - ducted inlet, ducted outlet. Performance ratings do not include the effects of appurtenances (accessories).

- The A-weighted sound ratings shown have been calculated per AMCA International Standard 301. Values shown are for inlet Lwi(A) sound power levels for installation type D - ducted inlet, ducted outlet. Ratings include the effects of duct end correction.

KTF1800 / RB31 / H / 12-7V (Forward)

875 rpm - 60 Hz

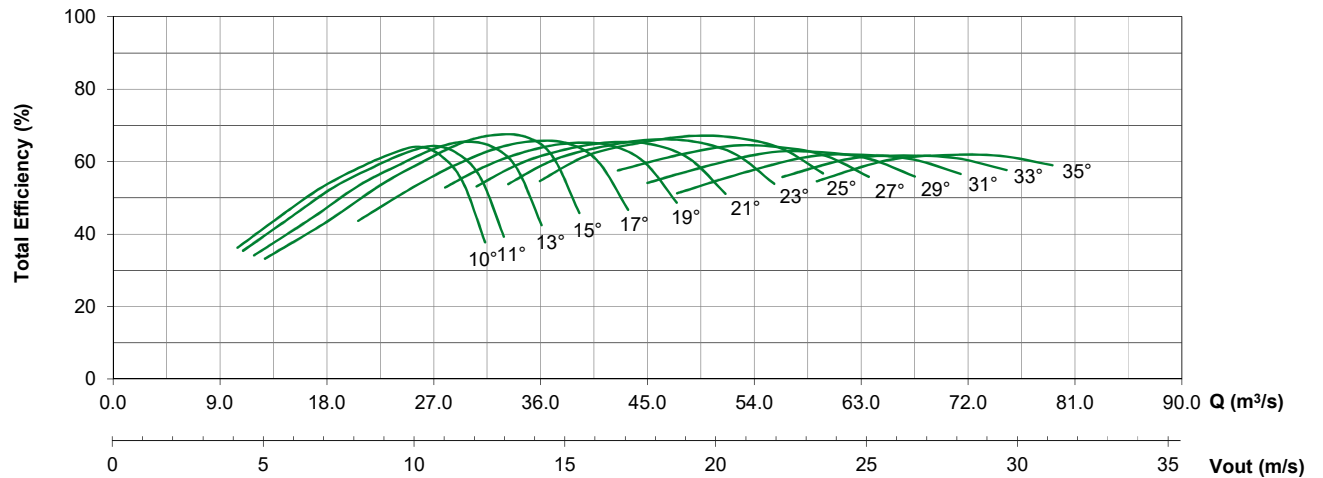
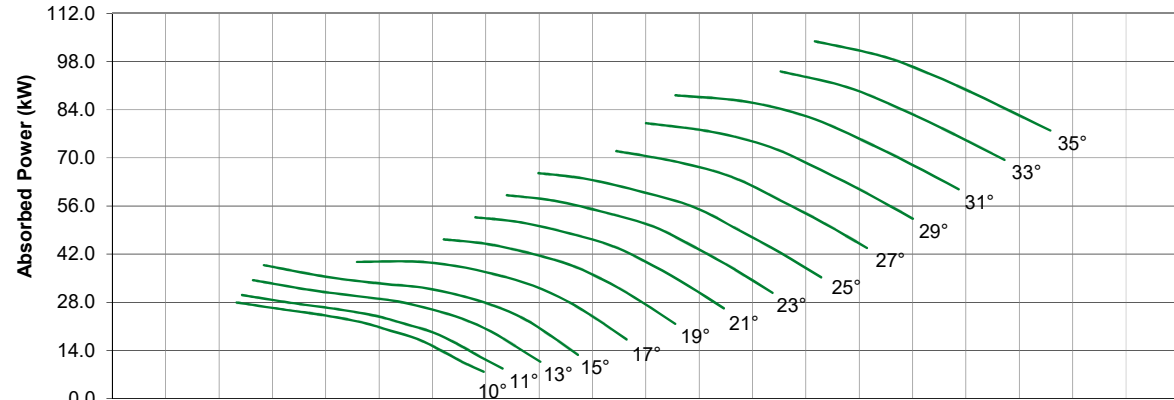
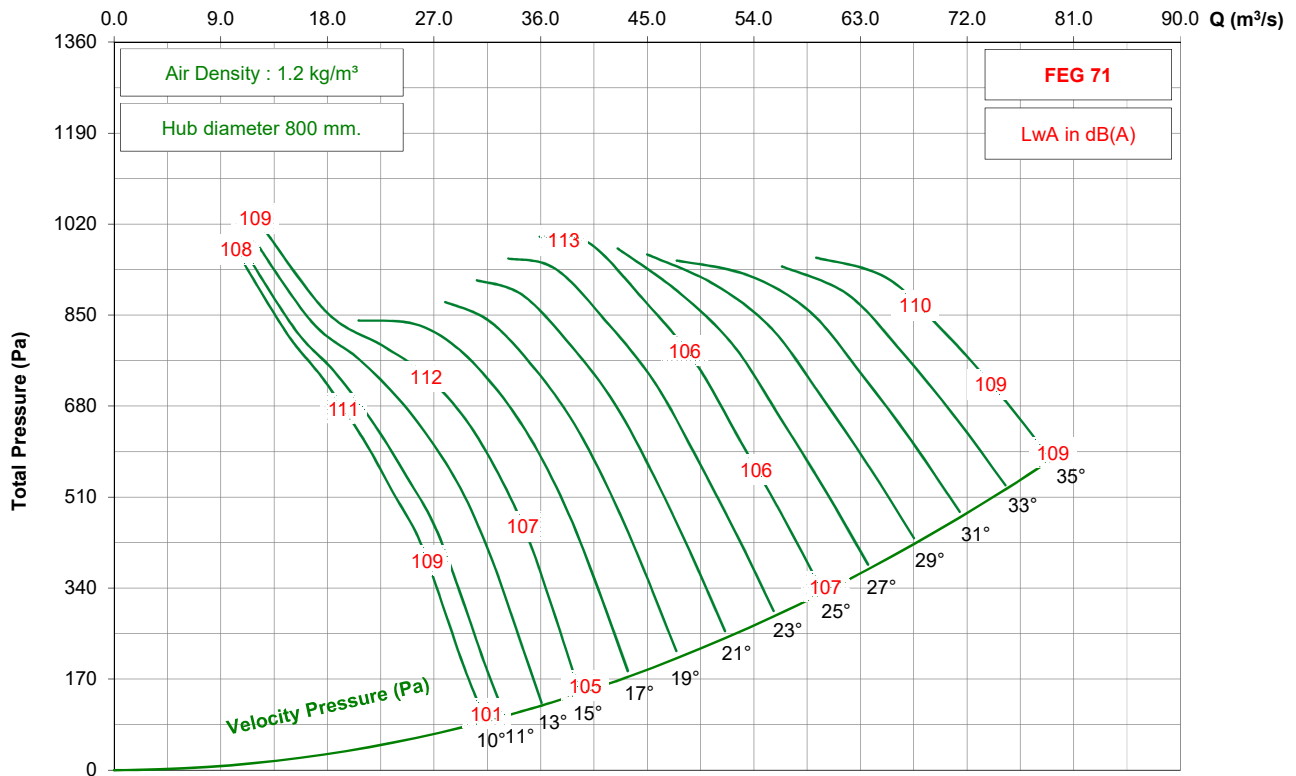

- Performance certified is for installation type D - ducted inlet, ducted outlet. Performance ratings do not include the effects of appurtenances (accessories).
 - The A-weighted sound ratings shown have been calculated per AMCA International Standard 301. Values shown are for inlet Lwi(A) sound power levels for installation type D - ducted inlet, ducted outlet. Ratings include the effects of duct end correction.

KTF1800 / RB31 / H / 12-7V (Reverse)

950 rpm - 50 Hz

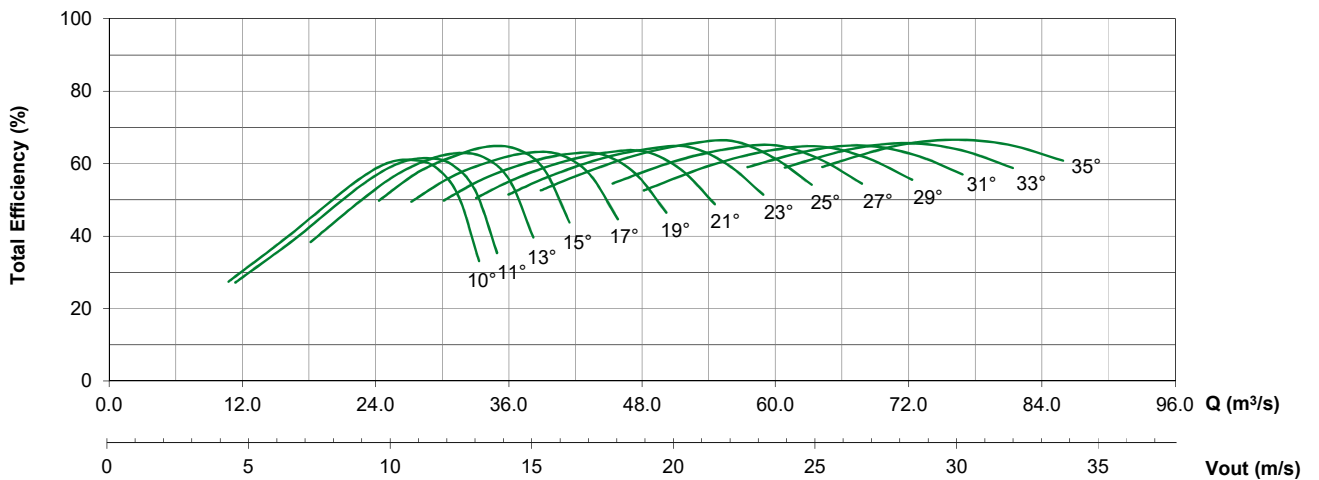
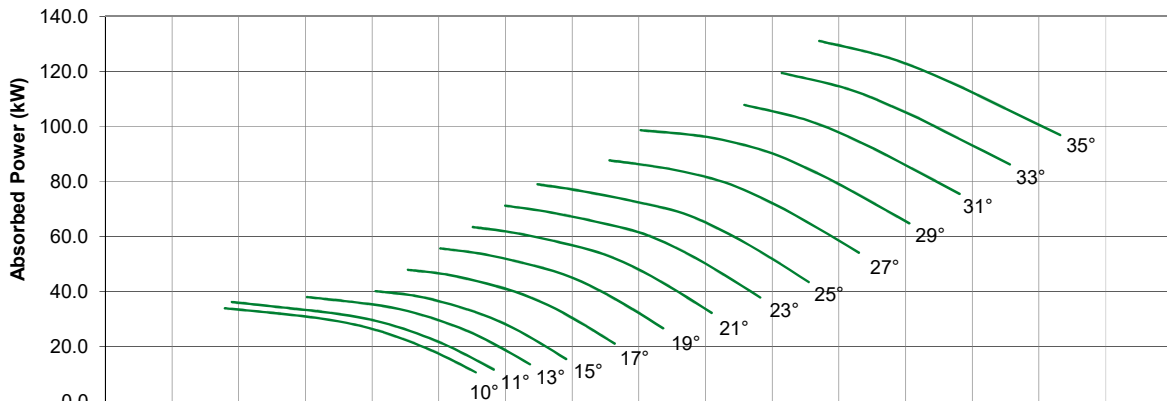
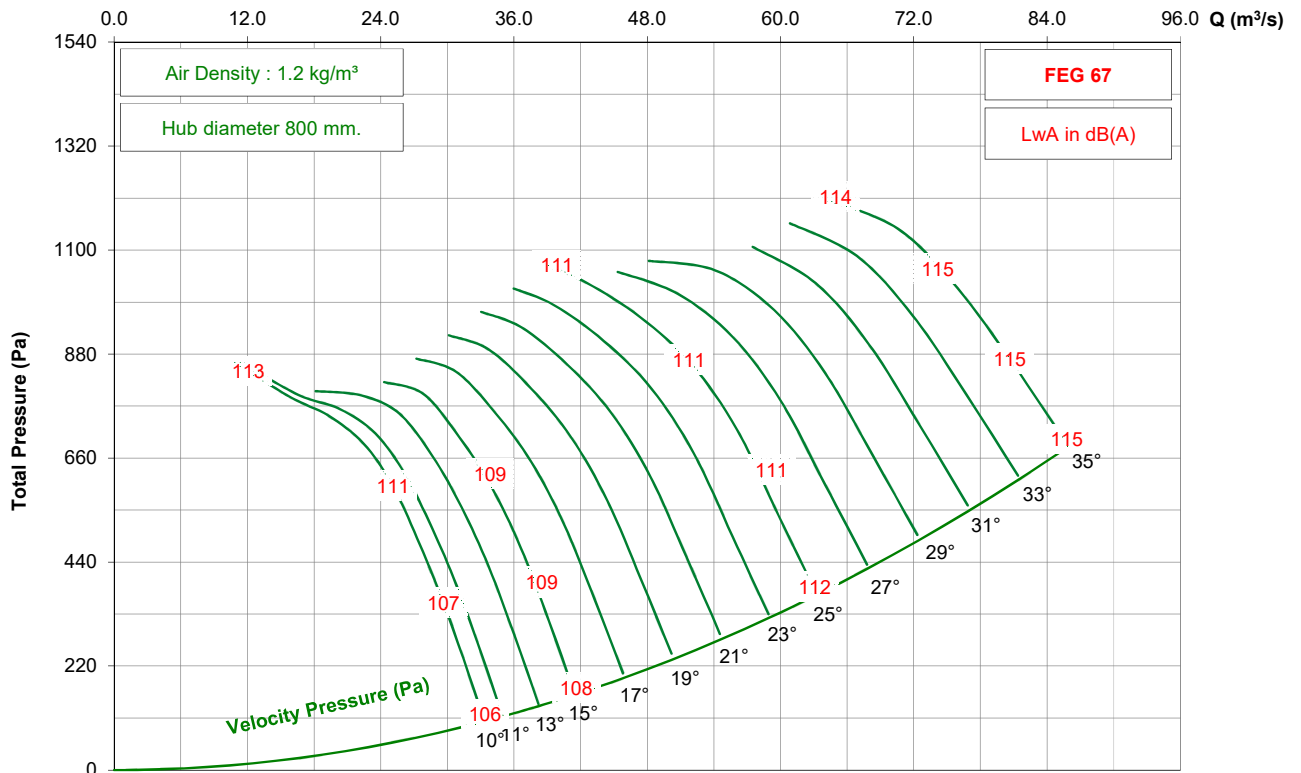

- Performance certified is for installation type D - ducted inlet, ducted outlet. Performance ratings do not include the effects of appurtenances (accessories).
 - The A-weighted sound ratings shown have been calculated per AMCA International Standard 301. Values shown are for inlet Lwi(A) sound power levels for installation type D - ducted inlet, ducted outlet. Ratings include the effects of duct end correction.

KTF1800 / RB31 / H / 12-7V (Reverse)

725 rpm - 50 Hz

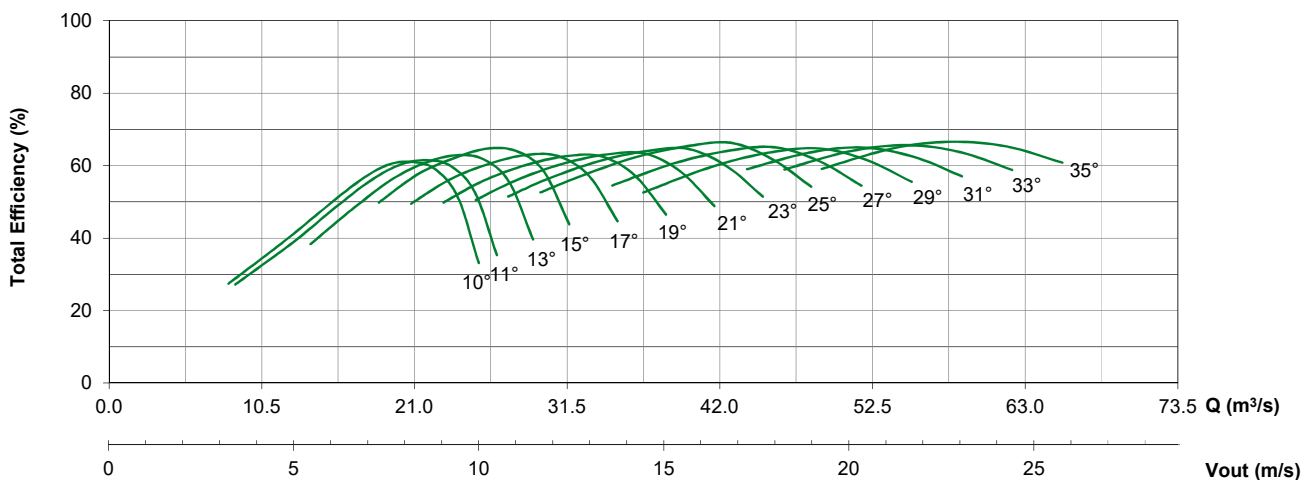
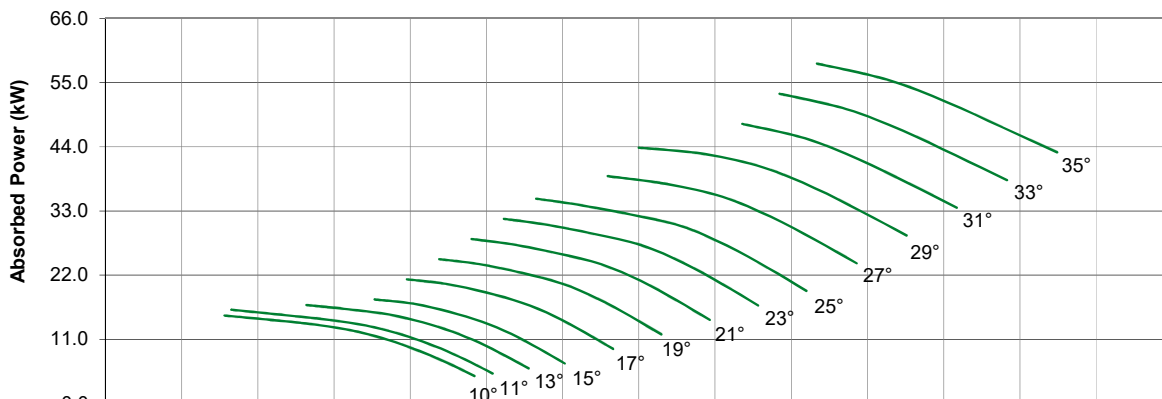
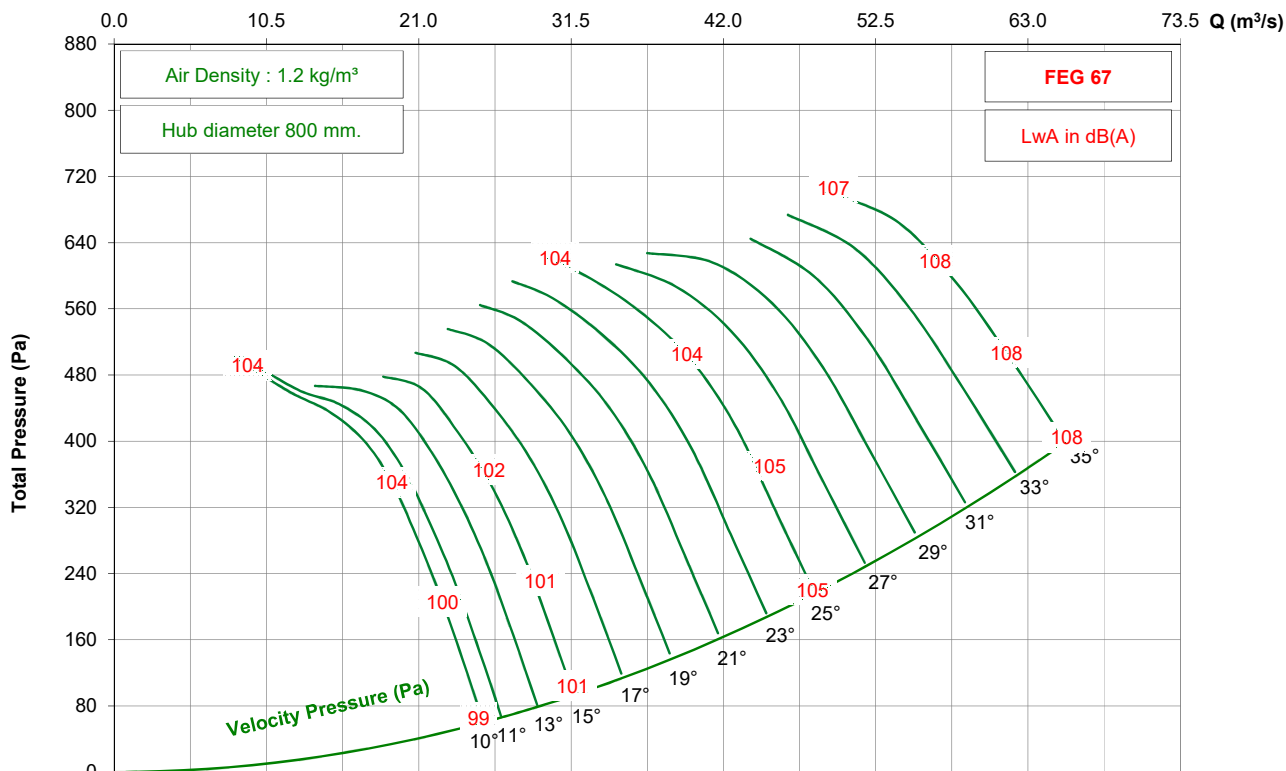

- Performance certified is for installation type D - ducted inlet, ducted outlet. Performance ratings do not include the effects of appurtenances (accessories).
 - The A-weighted sound ratings shown have been calculated per AMCA International Standard 301. Values shown are for inlet Lwi(A) sound power levels for installation type D - ducted inlet, ducted outlet. Ratings include the effects of duct end correction.

KTF1800 / RB31 / H / 12-7V (Reverse)

1150 rpm - 60 Hz

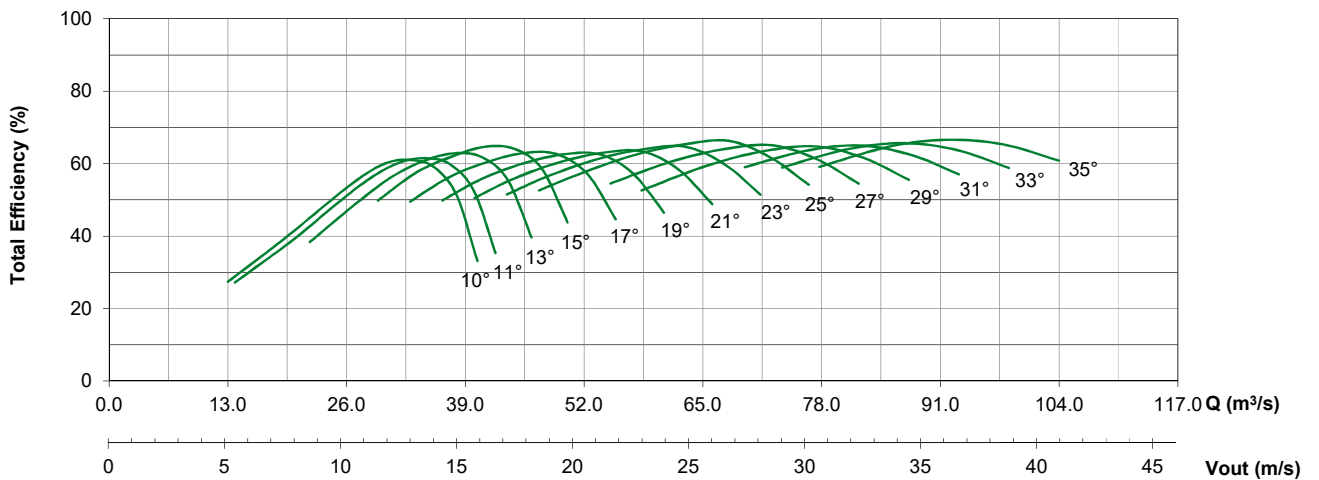
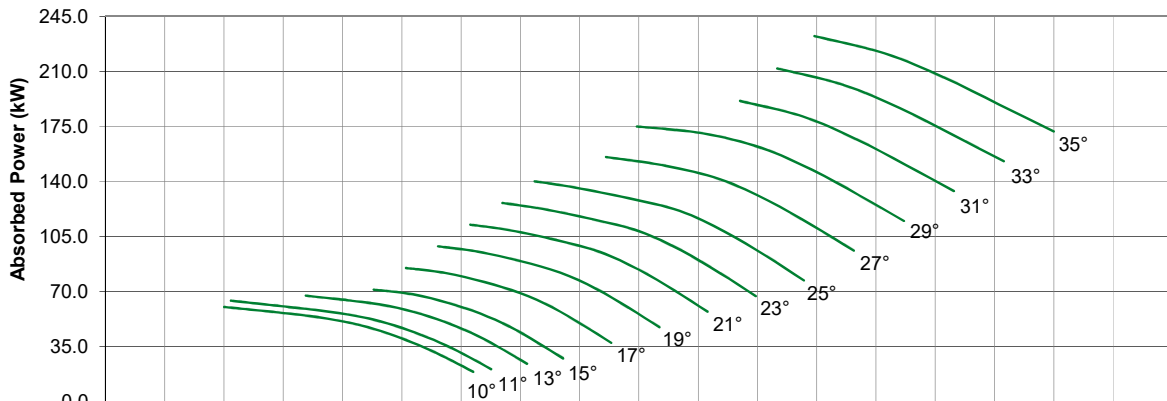
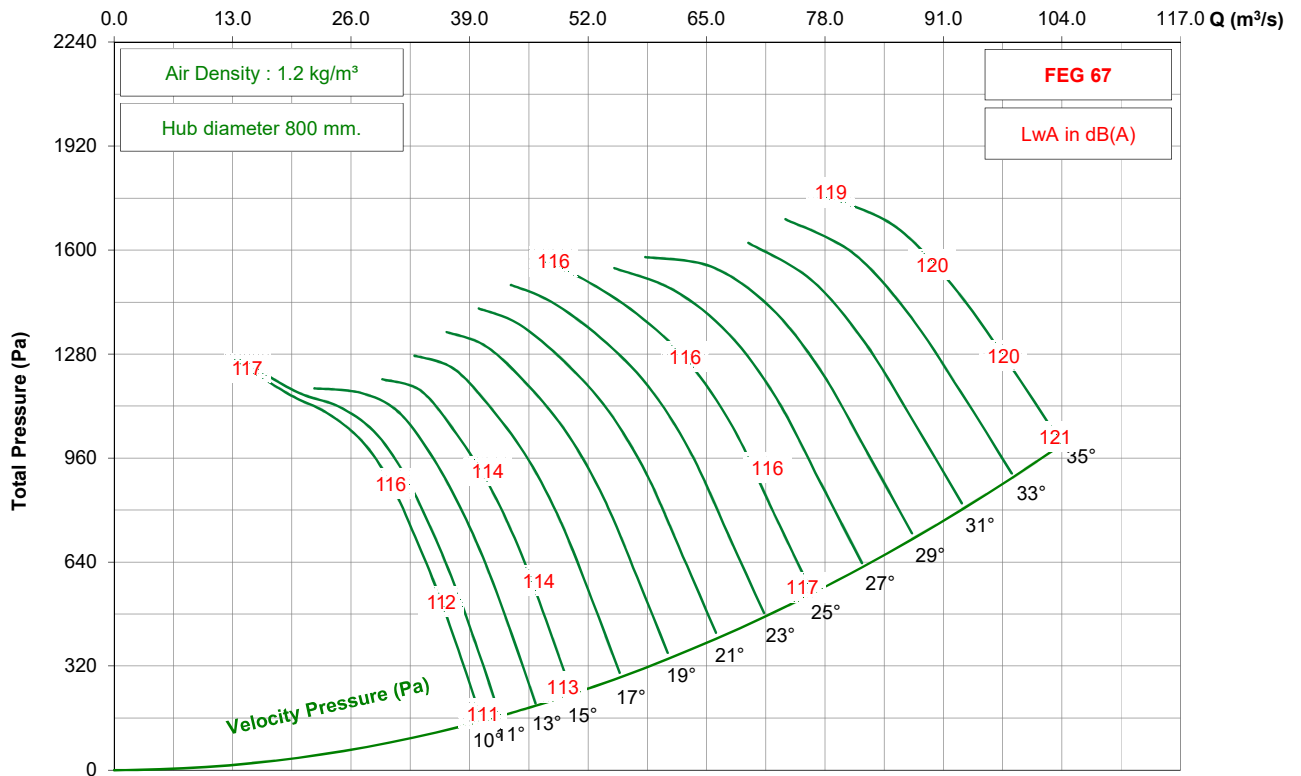

- Performance certified is for installation type D - ducted inlet, ducted outlet. Performance ratings do not include the effects of appurtenances (accessories).
 - The A-weighted sound ratings shown have been calculated per AMCA International Standard 301. Values shown are for inlet Lwi(A) sound power levels for installation type D - ducted inlet, ducted outlet. Ratings include the effects of duct end correction.

KTF1800 / RB31 / H / 12-7V (Reverse)

875 rpm - 60 Hz

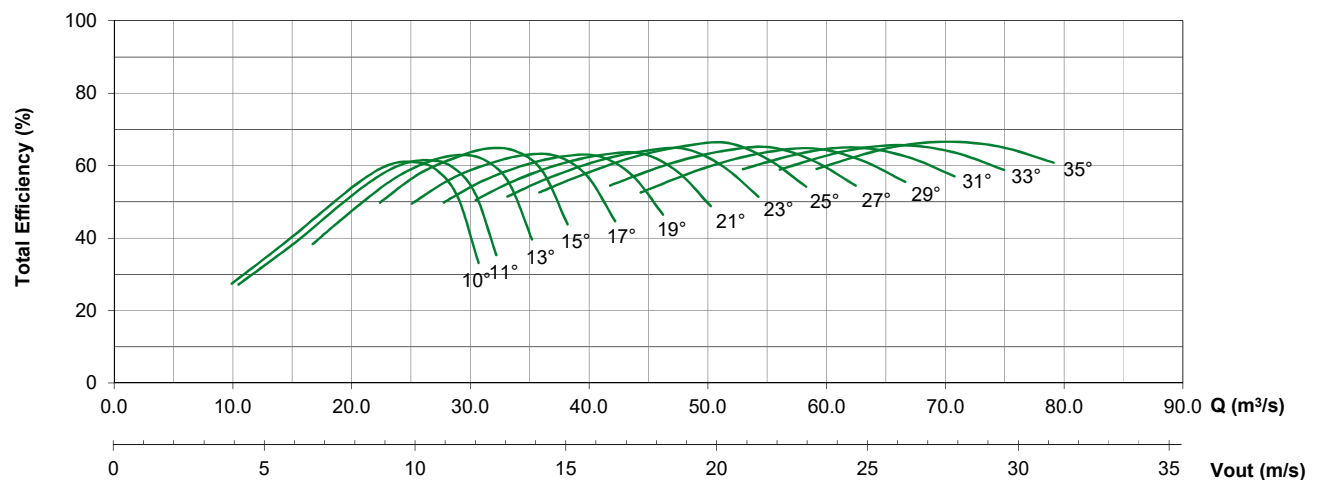
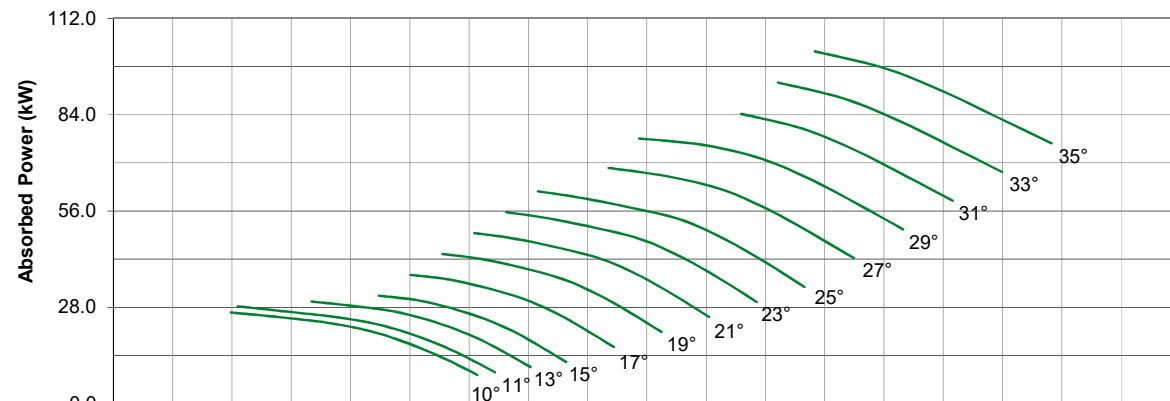
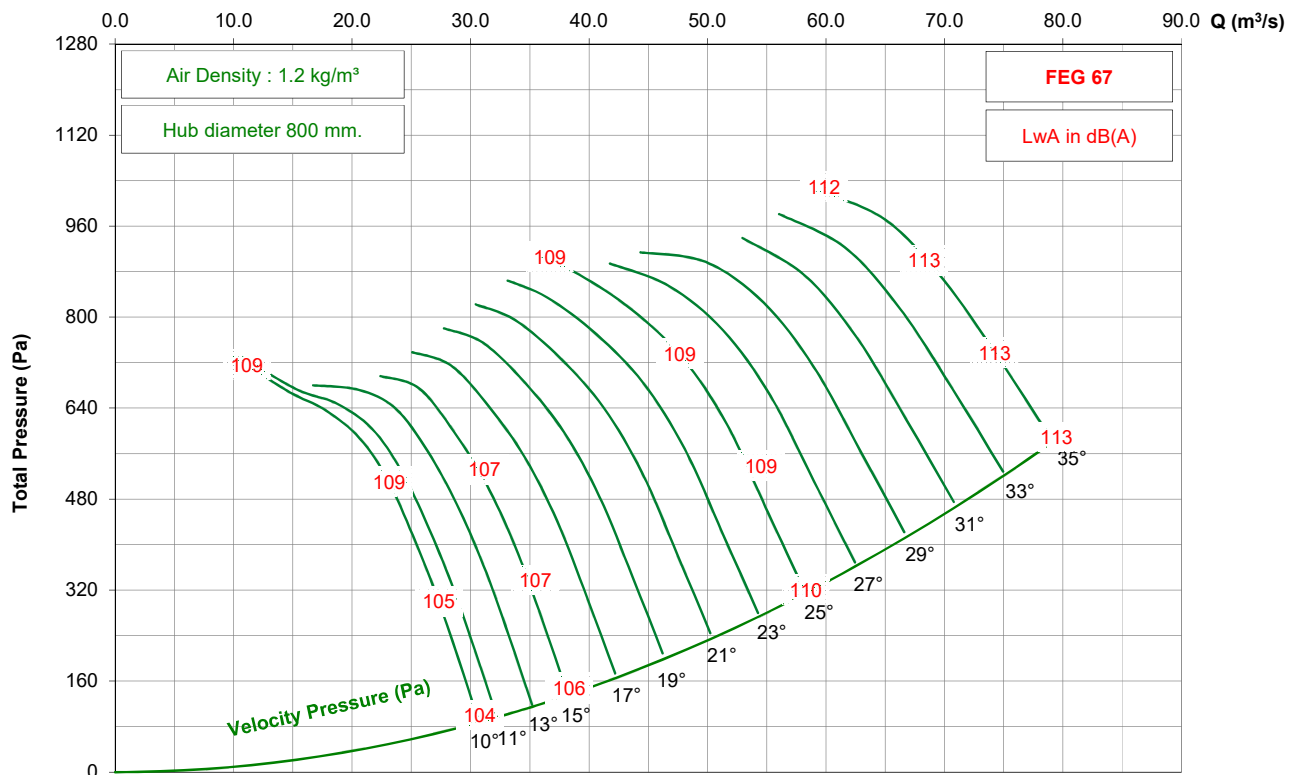

- Performance certified is for installation type D - ducted inlet, ducted outlet. Performance ratings do not include the effects of appurtenances (accessories).
 - The A-weighted sound ratings shown have been calculated per AMCA International Standard 301. Values shown are for inlet Lwi(A) sound power levels for installation type D - ducted inlet, ducted outlet. Ratings include the effects of duct end correction.

KTF2000 / RB35 / H / 12-7V (Forward)

950 rpm - 50 Hz

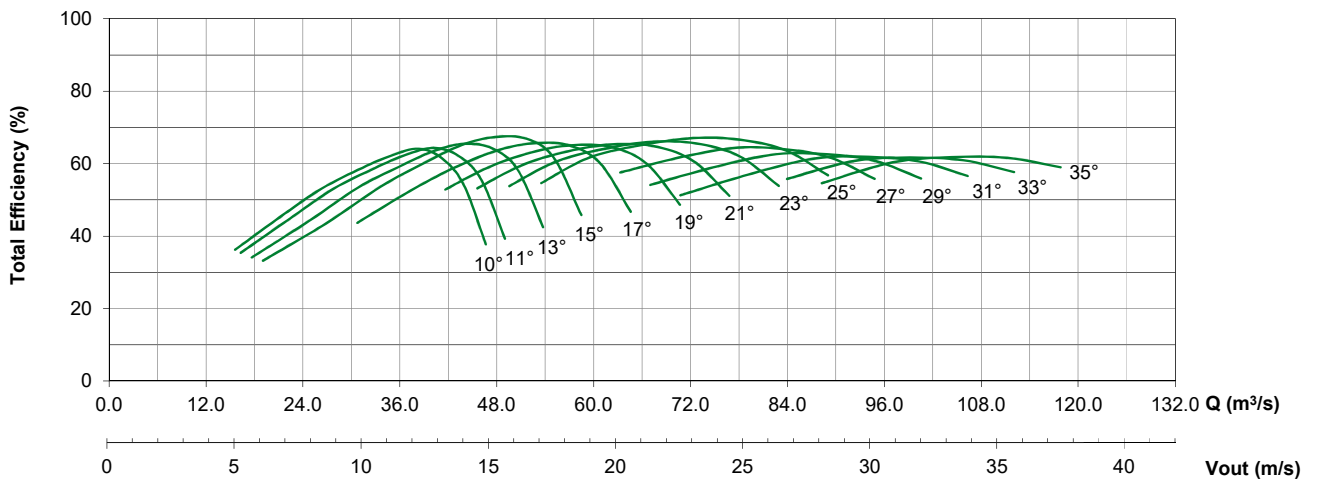
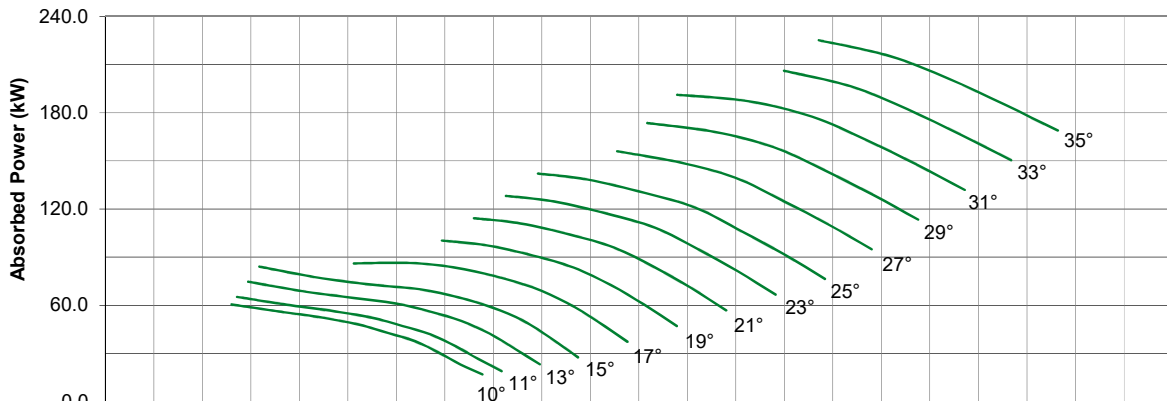
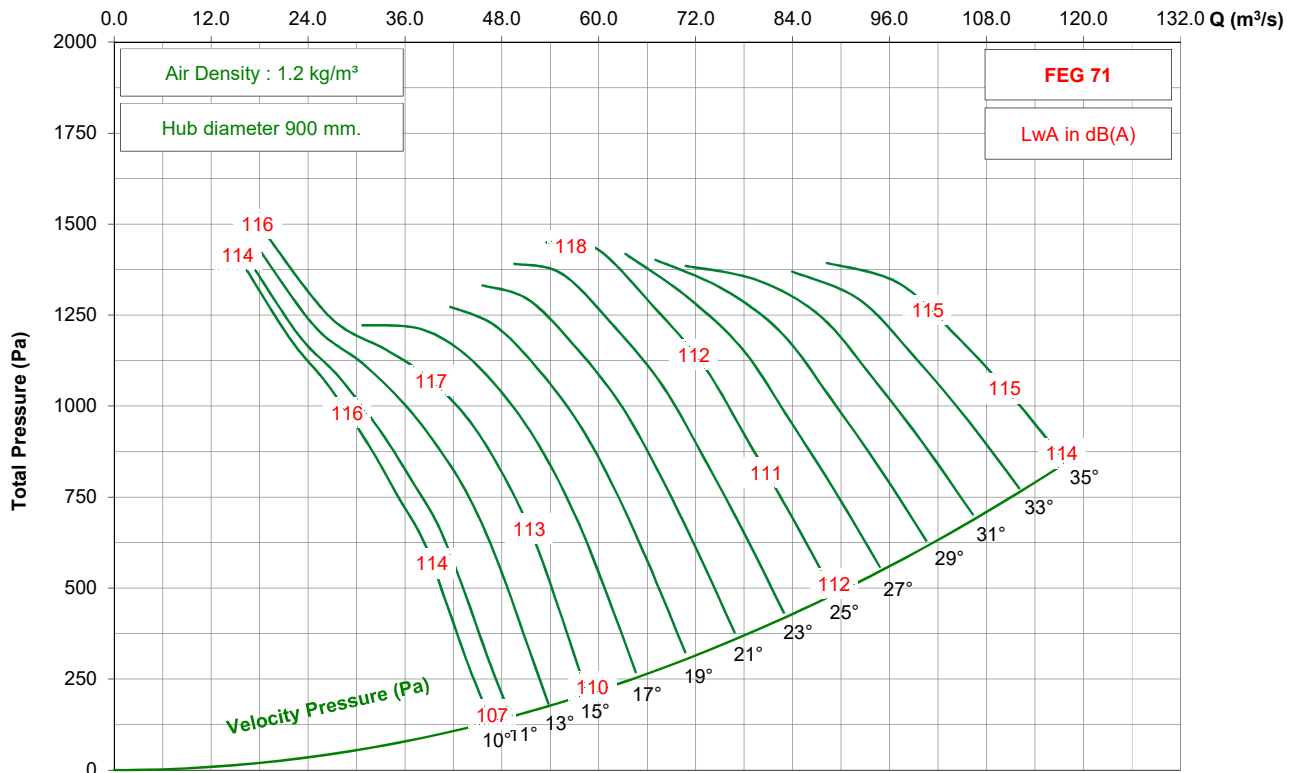

- Performance certified is for installation type D - ducted inlet, ducted outlet. Performance ratings do not include the effects of appurtenances (accessories).
 - The A-weighted sound ratings shown have been calculated per AMCA International Standard 301. Values shown are for inlet Lwi(A) sound power levels for installation type D - ducted inlet, ducted outlet. Ratings include the effects of duct end correction.

KTF2000 / RB35 / H / 12-7V (Forward)

725 rpm - 50 Hz

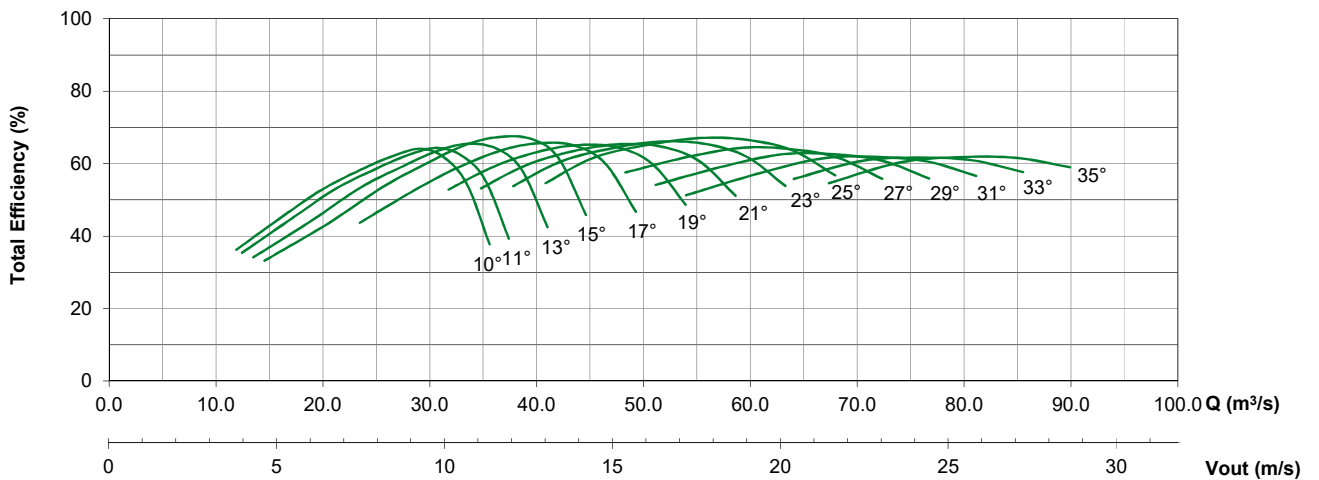
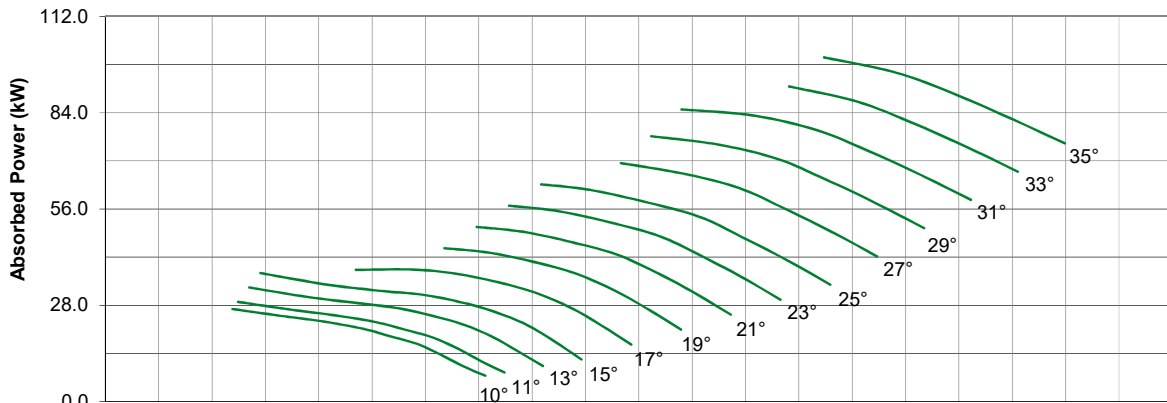
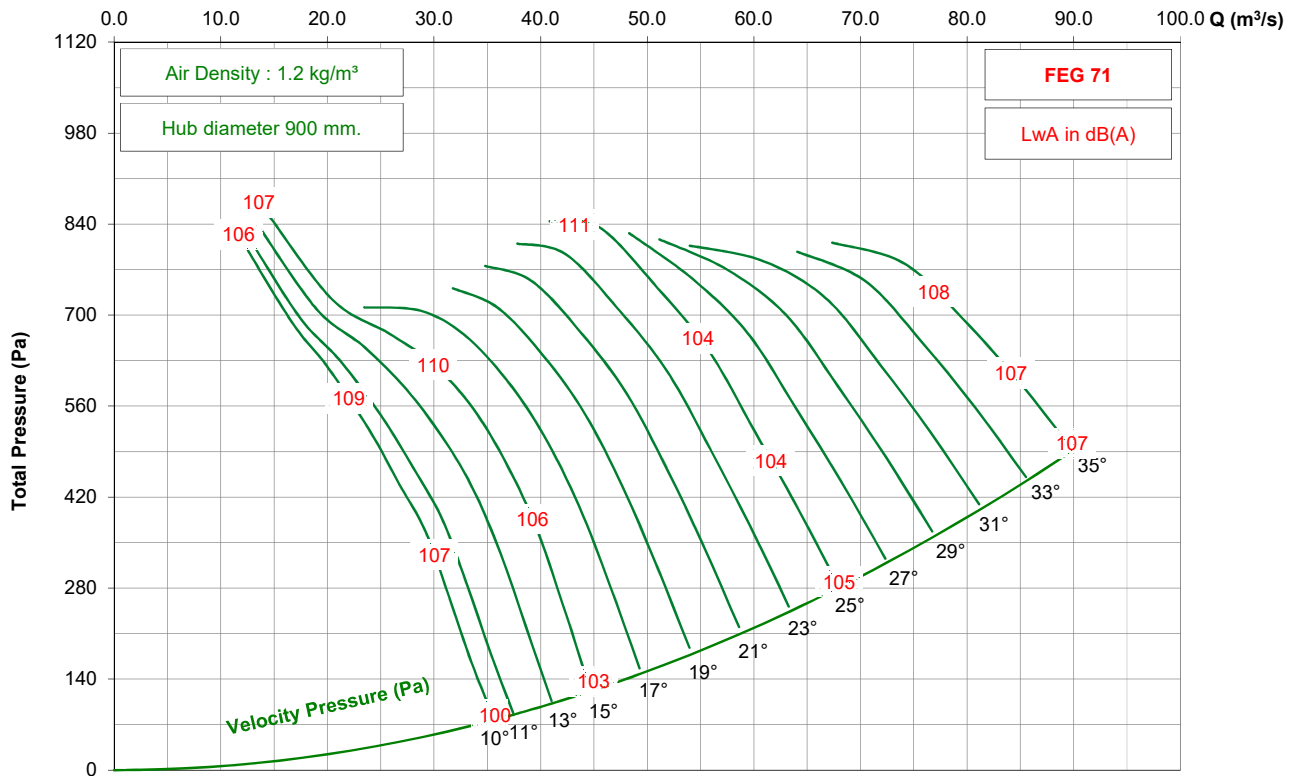

- Performance certified is for installation type D - ducted inlet, ducted outlet. Performance ratings do not include the effects of appurtenances (accessories).
 - The A-weighted sound ratings shown have been calculated per AMCA International Standard 301. Values shown are for inlet Lwi(A) sound power levels for installation type D - ducted inlet, ducted outlet. Ratings include the effects of duct end correction.

KTF2000 / RB35 / H / 12-7V (Forward)

875 rpm - 60 Hz

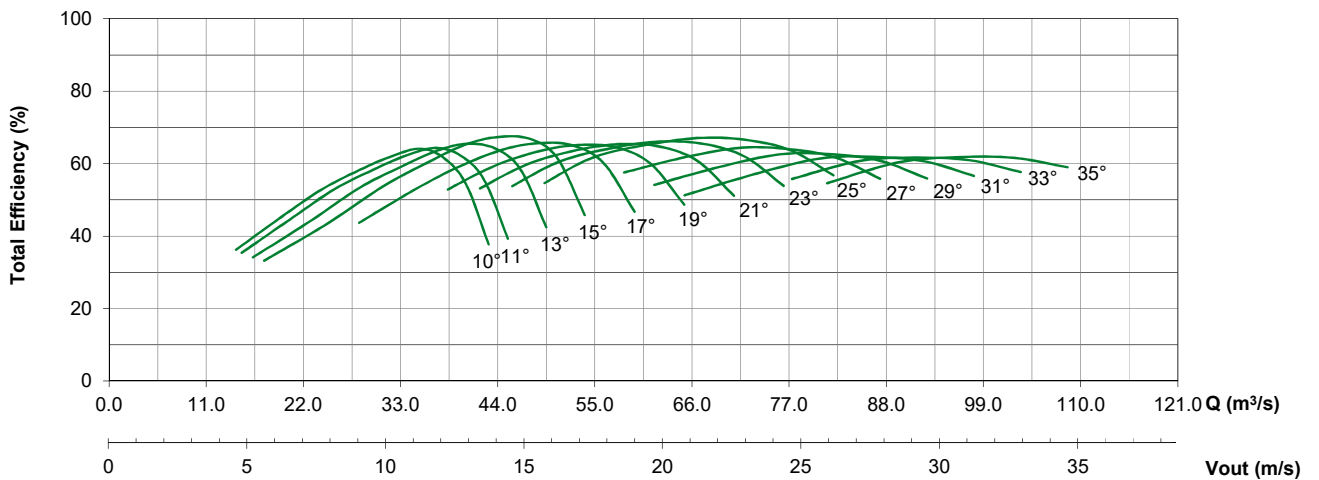
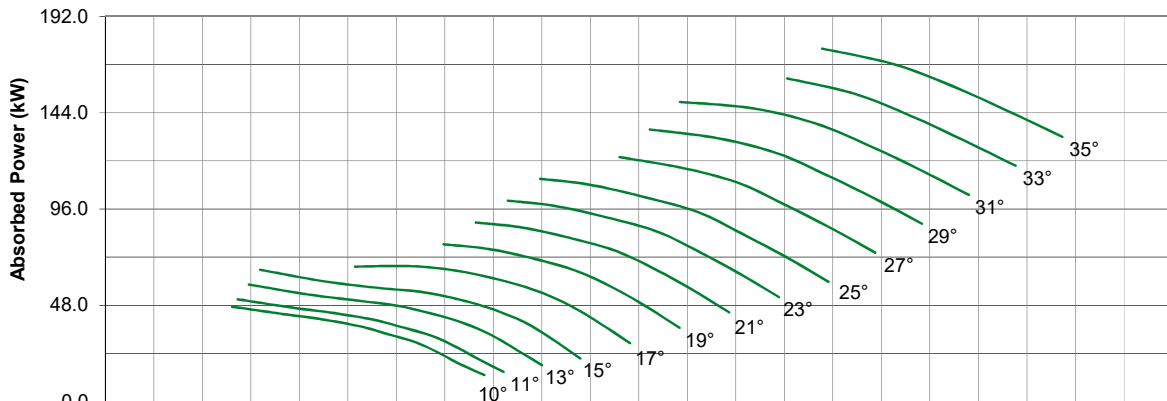
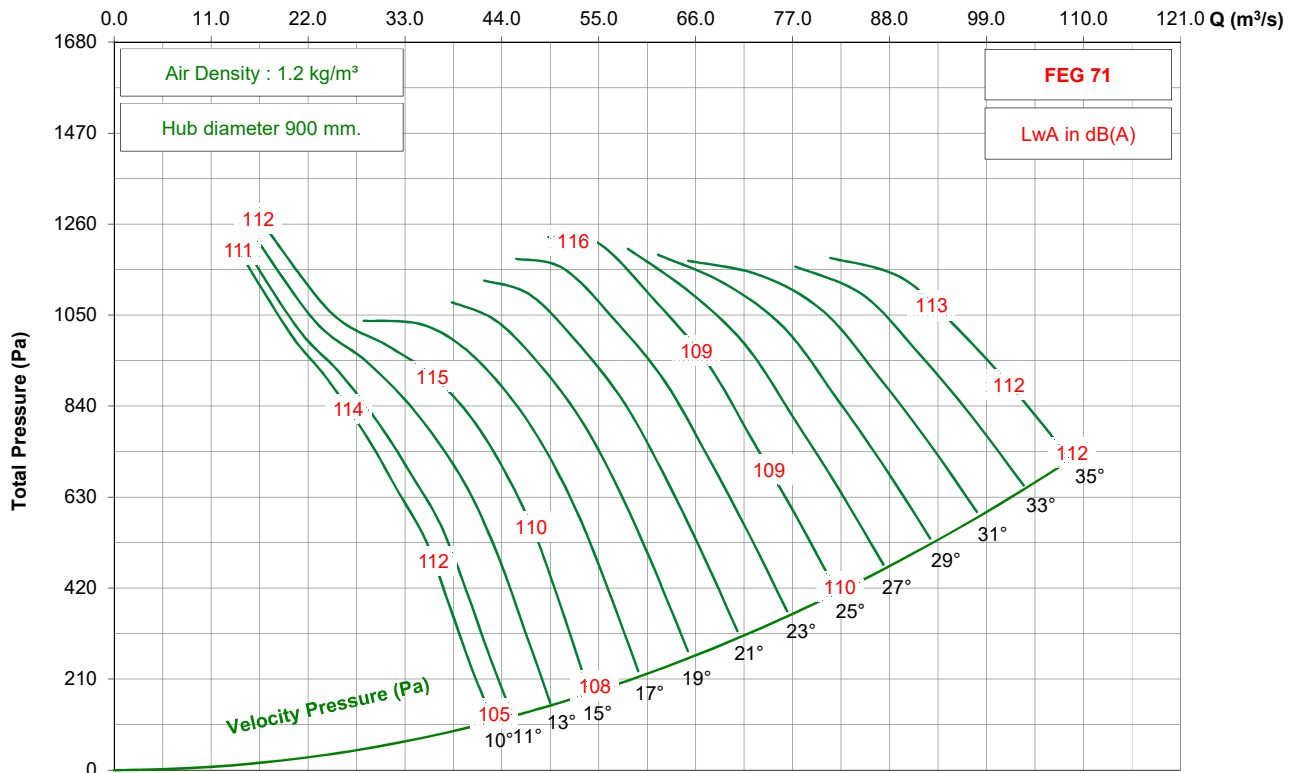

- Performance certified is for installation type D - ducted inlet, ducted outlet. Performance ratings do not include the effects of appurtenances (accessories).
 - The A-weighted sound ratings shown have been calculated per AMCA International Standard 301. Values shown are for inlet Lwi(A) sound power levels for installation type D - ducted inlet, ducted outlet. Ratings include the effects of duct end correction.

KTF2000 / RB35 / H / 12-7V (Reverse)

950 rpm - 50 Hz

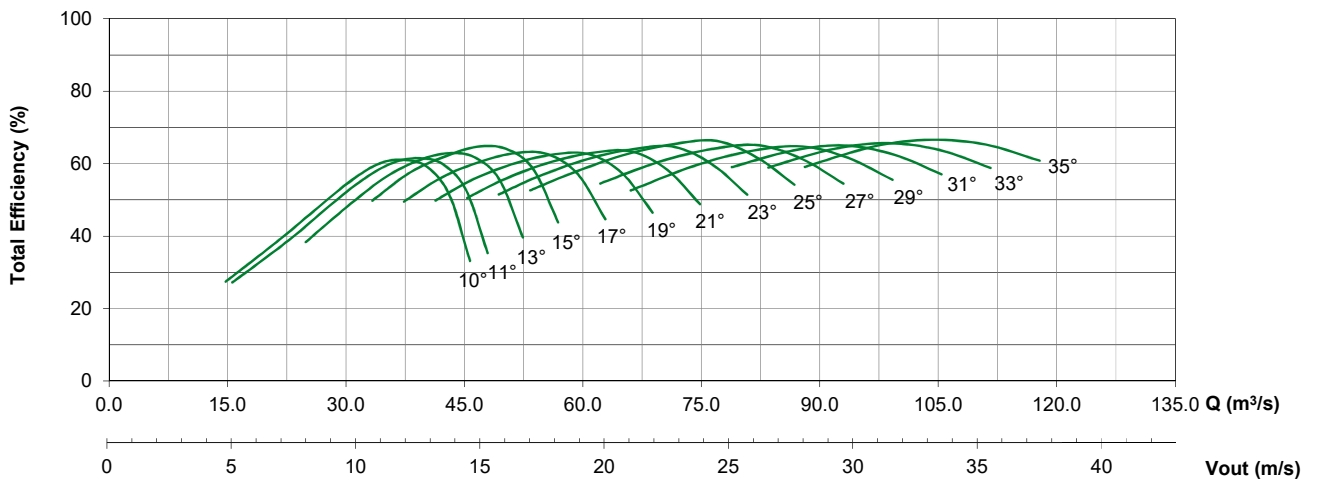
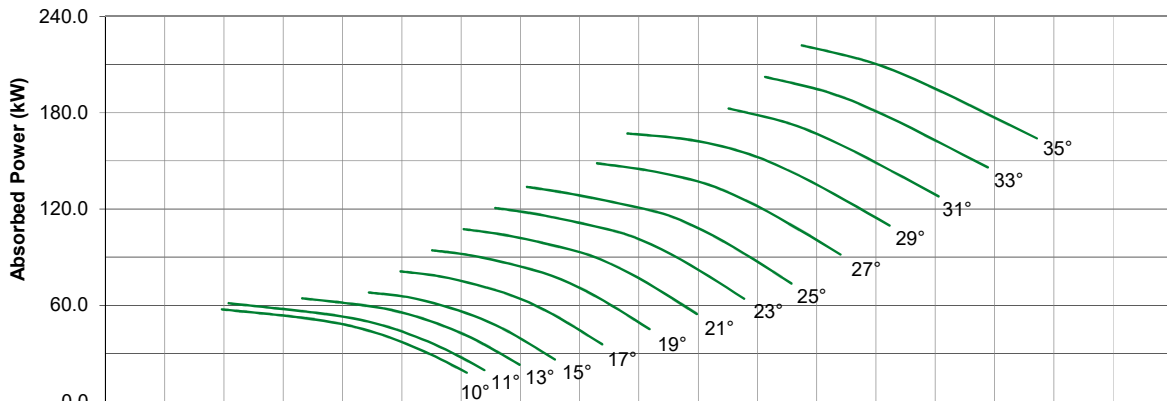
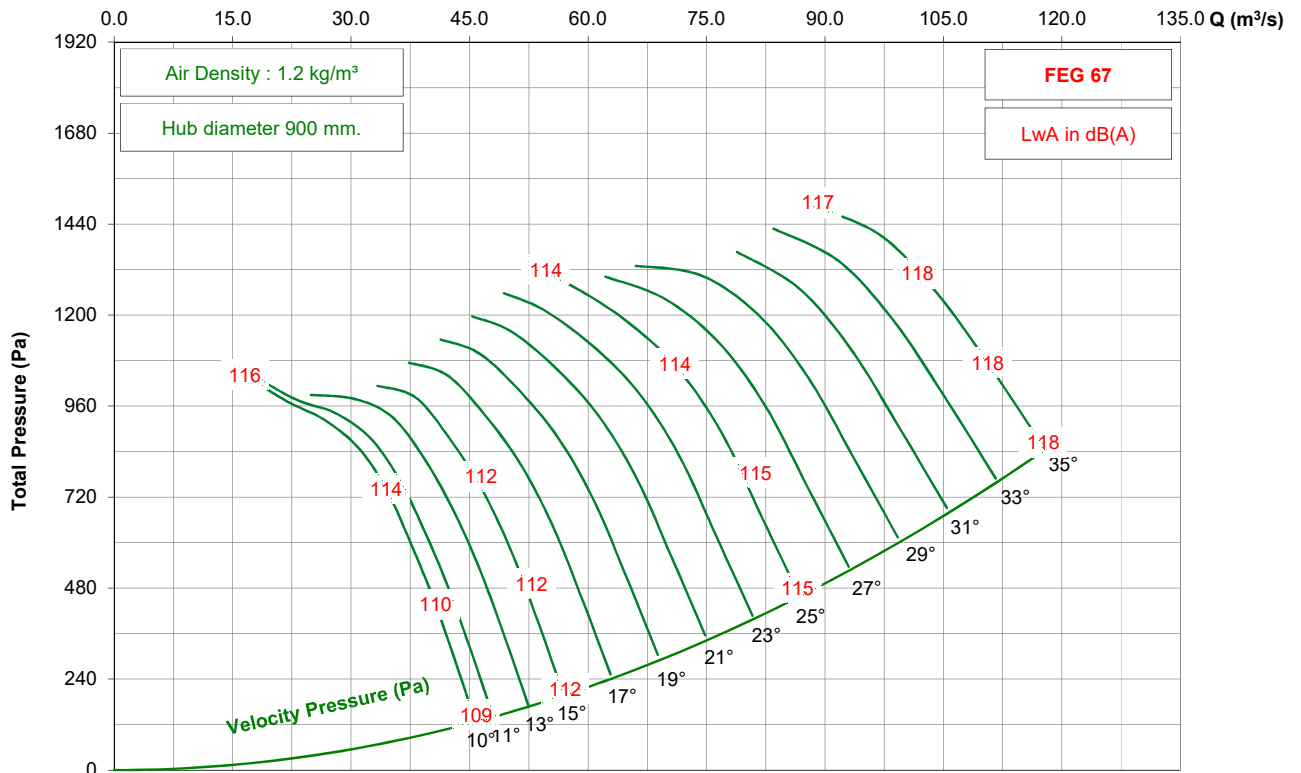

- Performance certified is for installation type D - ducted inlet, ducted outlet. Performance ratings do not include the effects of appurtenances (accessories).
 - The A-weighted sound ratings shown have been calculated per AMCA International Standard 301. Values shown are for inlet Lwi(A) sound power levels for installation type D - ducted inlet, ducted outlet. Ratings include the effects of duct end correction.

KTF2000 / RB35 / H / 12-7V (Reverse)

725 rpm - 50 Hz

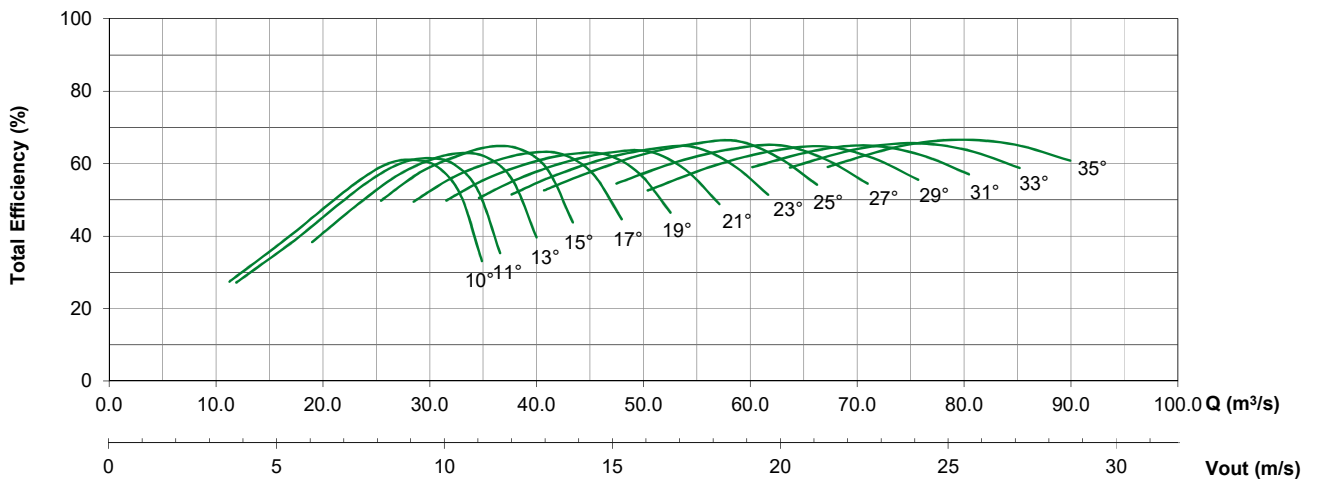
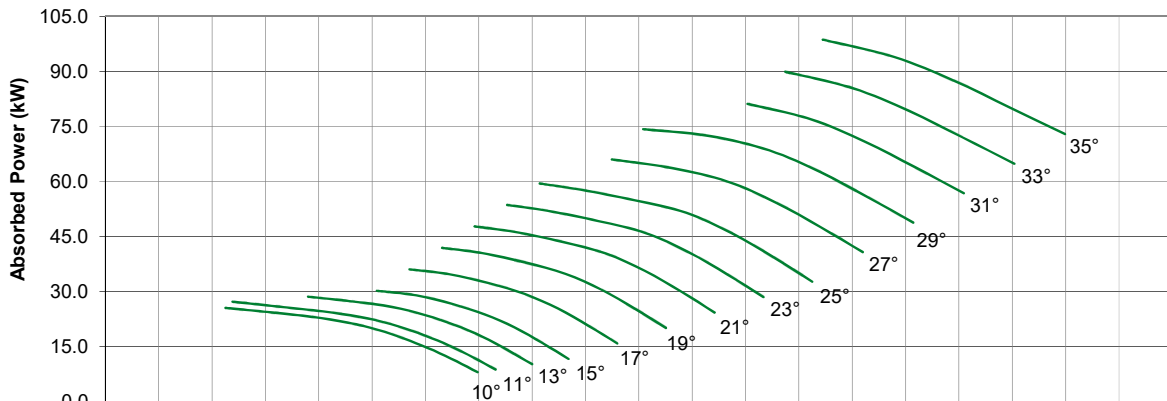
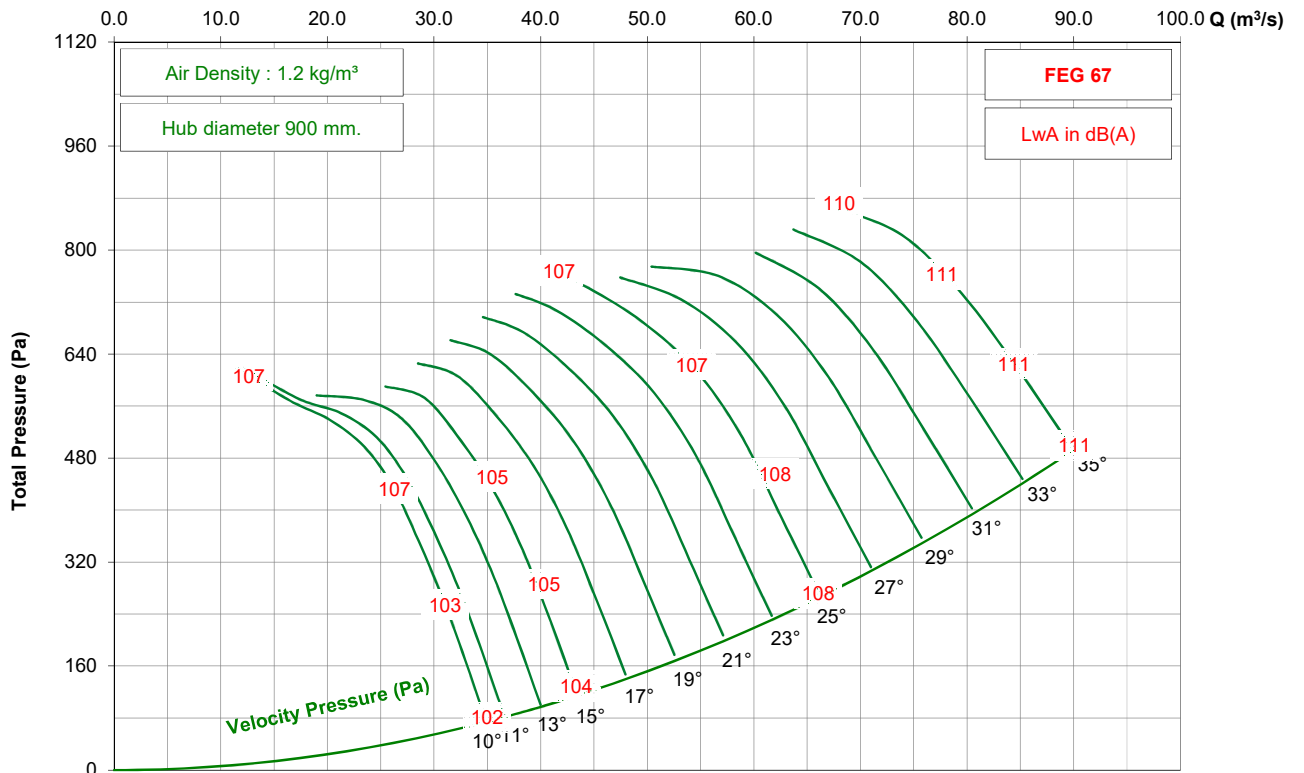

- Performance certified is for installation type D - ducted inlet, ducted outlet. Performance ratings do not include the effects of appurtenances (accessories).

- The A-weighted sound ratings shown have been calculated per AMCA International Standard 301. Values shown are for inlet Lwi(A) sound power levels for installation type D - ducted inlet, ducted outlet. Ratings include the effects of duct end correction.

KTF2000 / RB35 / H / 12-7V (Reverse)

875 rpm - 60 Hz

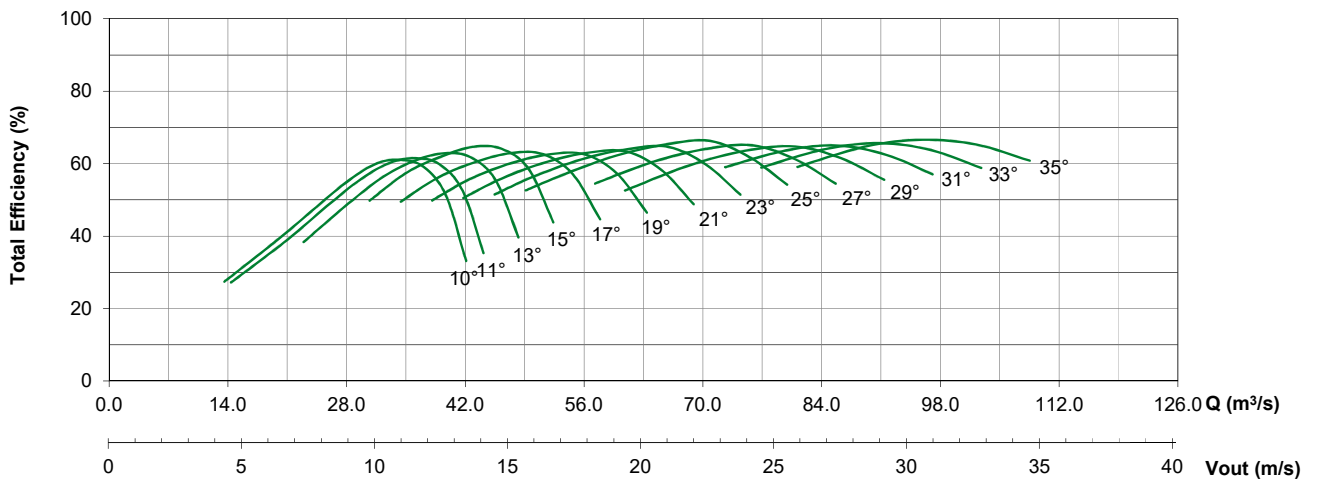
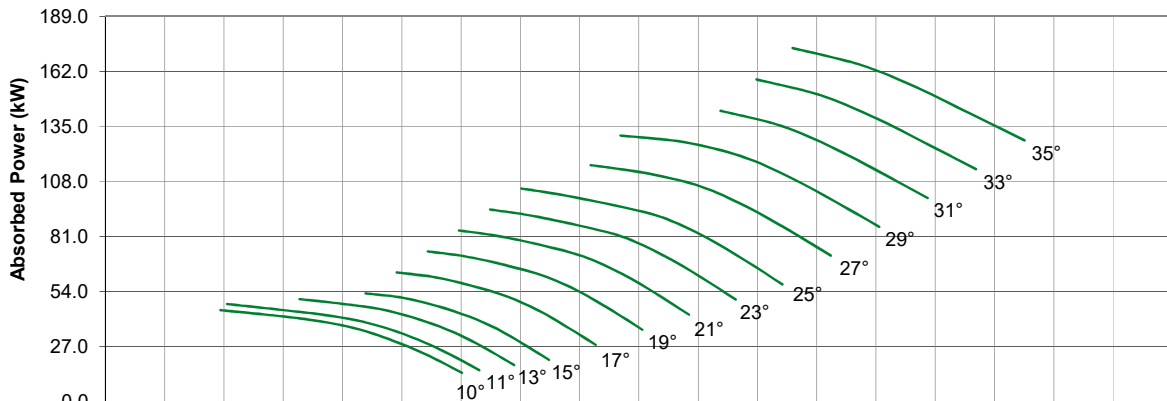
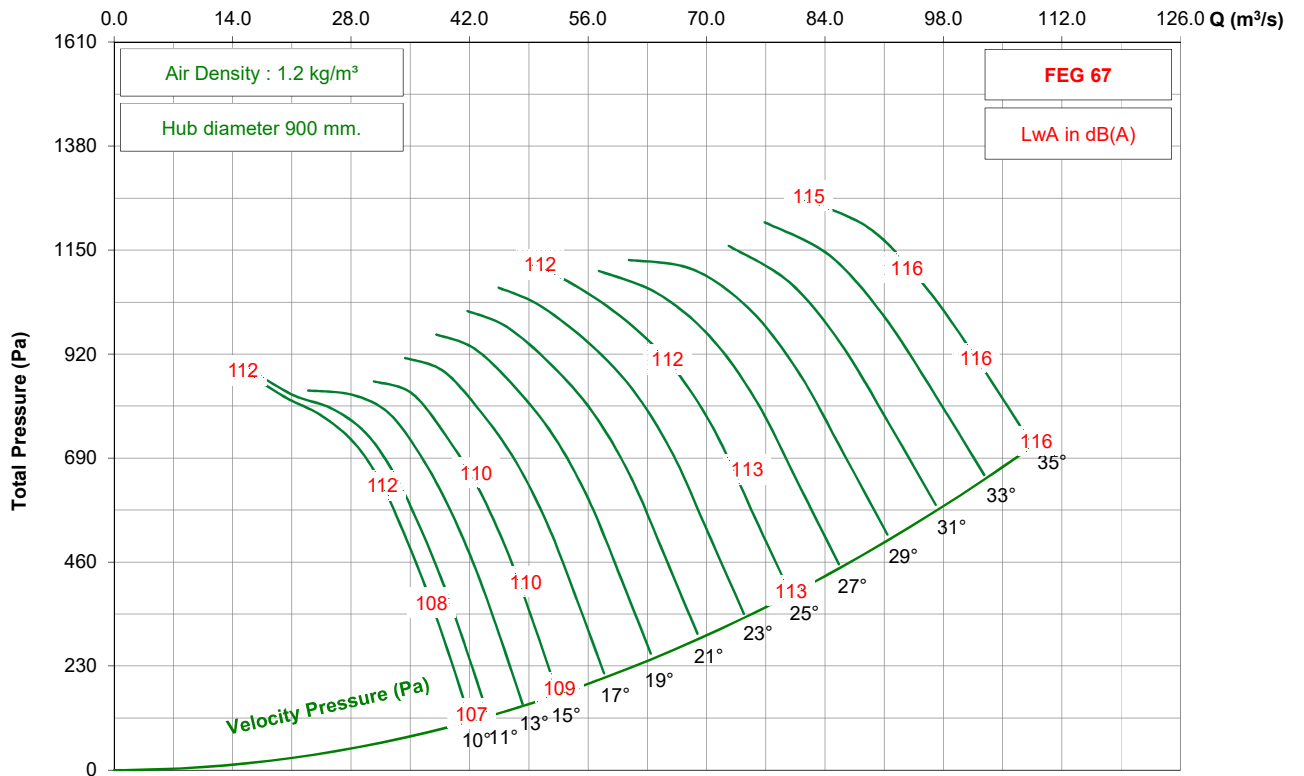

- Performance certified is for installation type D - ducted inlet, ducted outlet. Performance ratings do not include the effects of appurtenances (accessories).

- The A-weighted sound ratings shown have been calculated per AMCA International Standard 301. Values shown are for inlet Lwi(A) sound power levels for installation type D - ducted inlet, ducted outlet. Ratings include the effects of duct end correction.

KTF2240 / RB40 / H / 12-7V (Forward)

950 rpm - 50 Hz

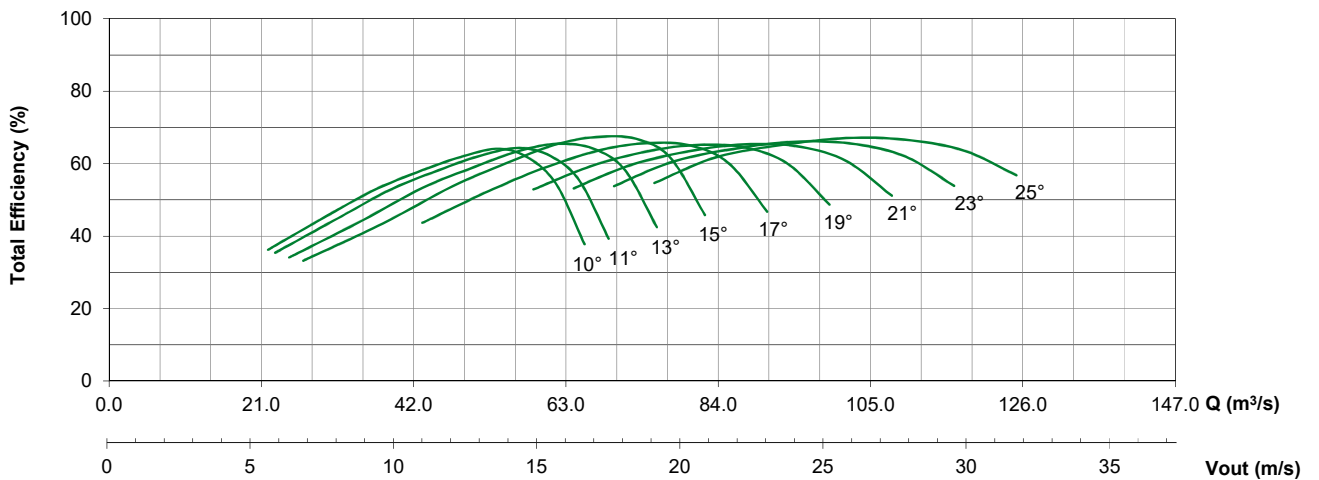
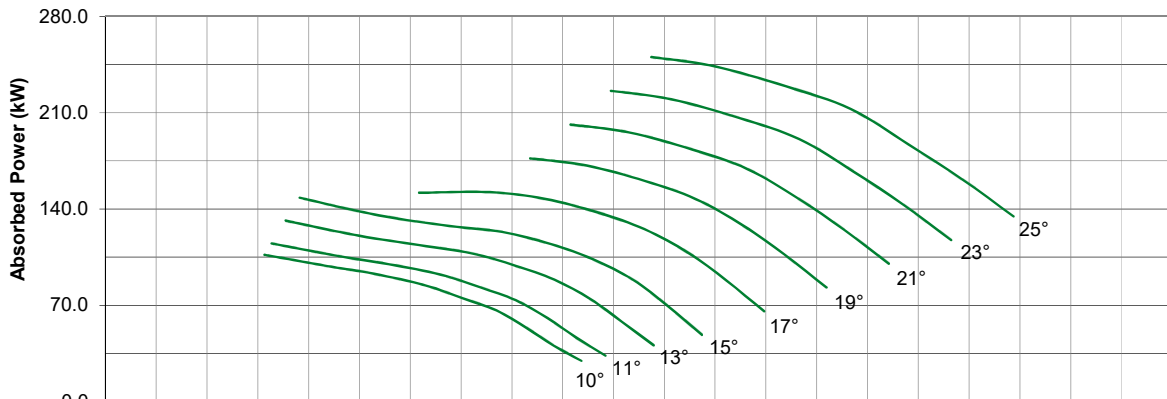
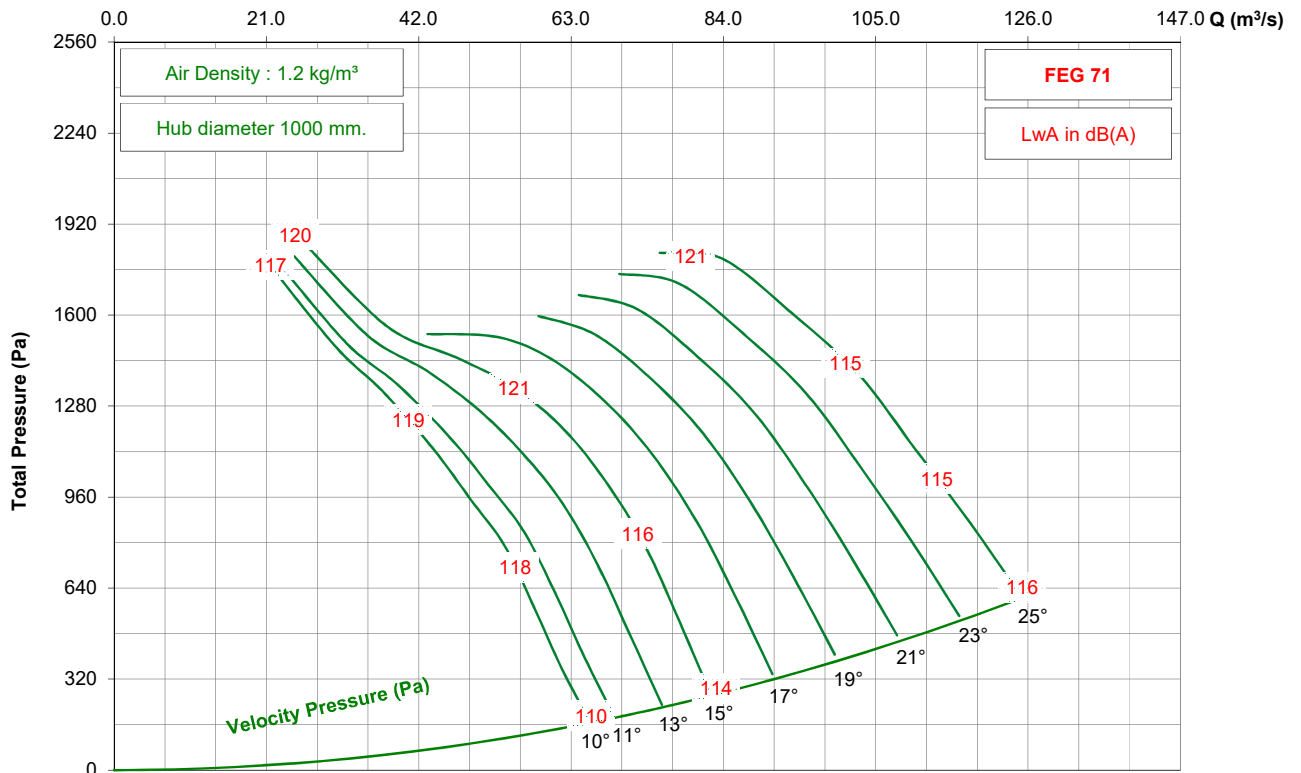

- Performance certified is for installation type D - ducted inlet, ducted outlet. Performance ratings do not include the effects of appurtenances (accessories).
 - The A-weighted sound ratings shown have been calculated per AMCA International Standard 301. Values shown are for inlet Lwi(A) sound power levels for installation type D - ducted inlet, ducted outlet. Ratings include the effects of duct end correction.

KTF2240 / RB40 / H / 12-7V (Forward)

725 rpm - 50 Hz

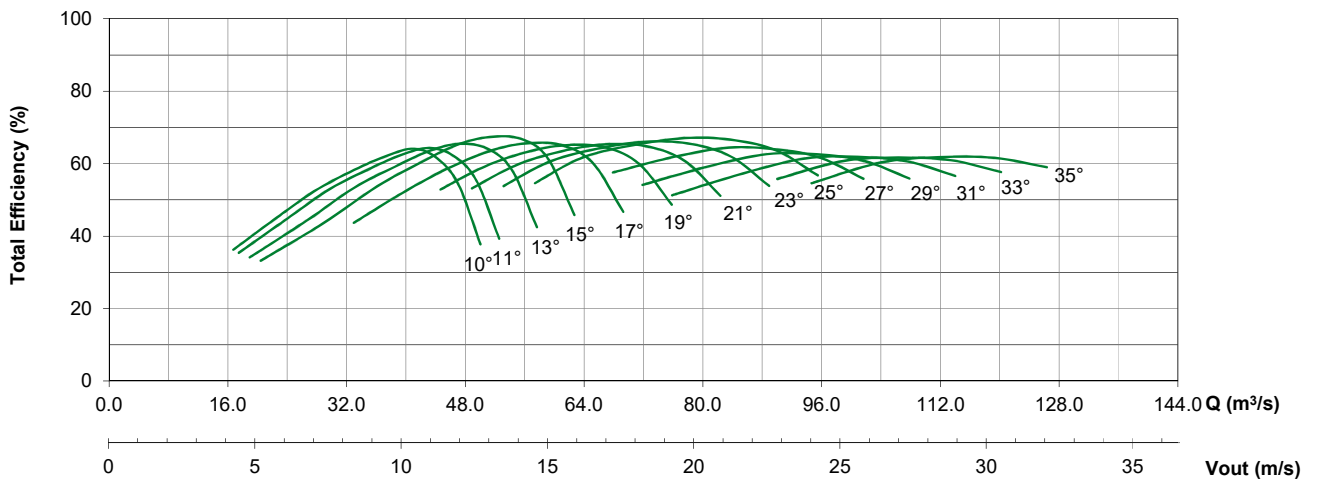
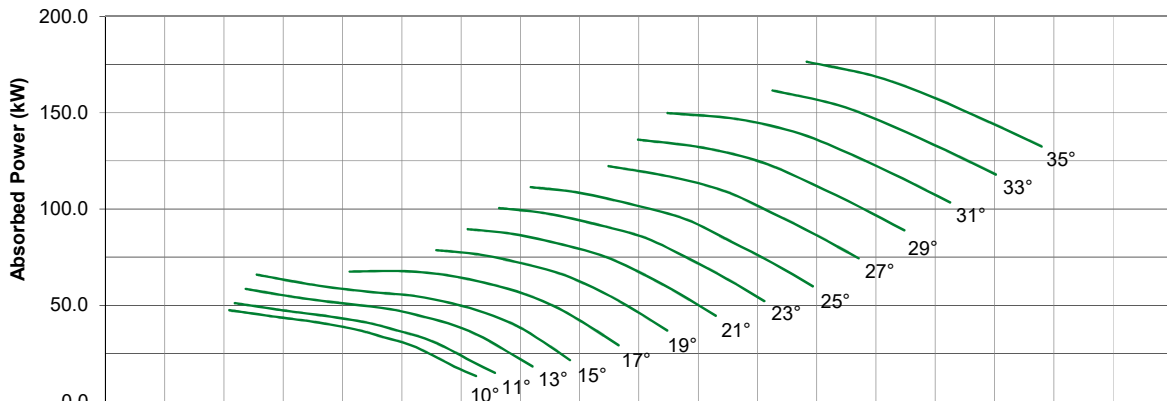
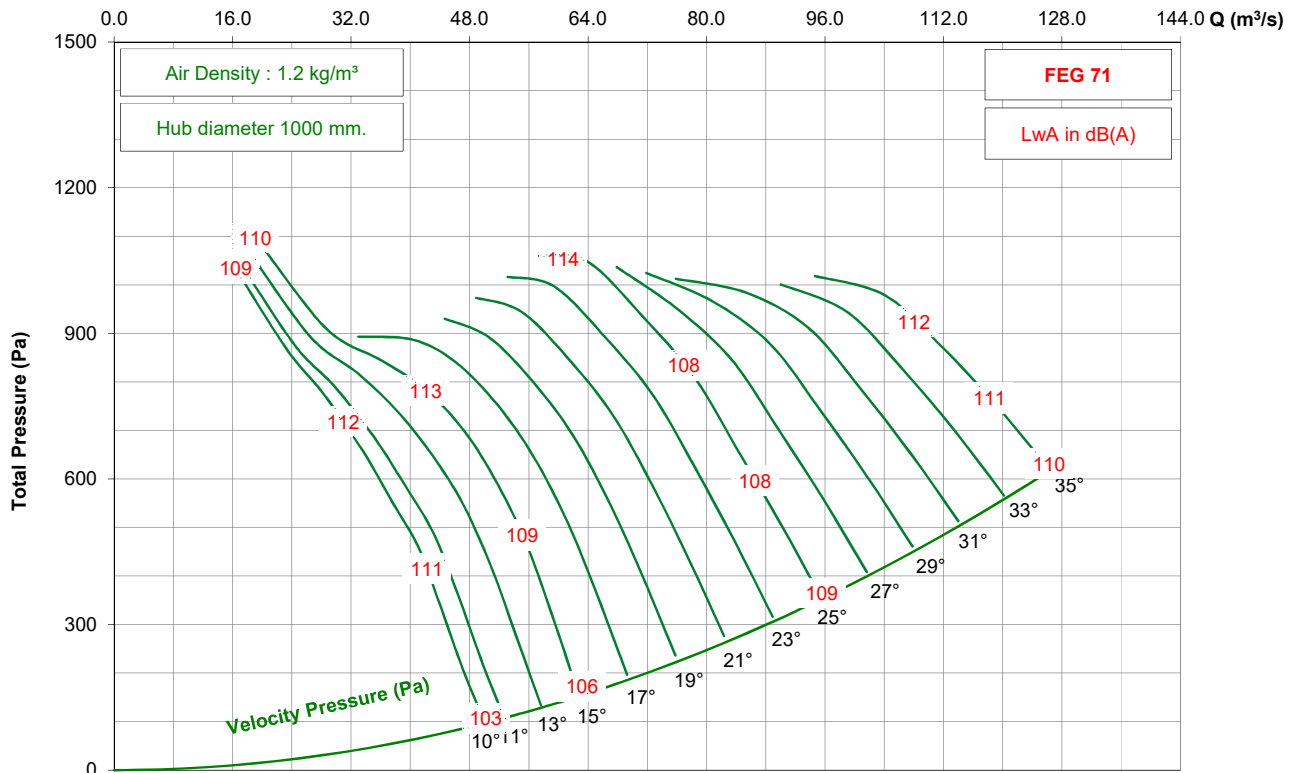

- Performance certified is for installation type D - ducted inlet, ducted outlet. Performance ratings do not include the effects of appurtenances (accessories).
 - The A-weighted sound ratings shown have been calculated per AMCA International Standard 301. Values shown are for inlet Lwi(A) sound power levels for installation type D - ducted inlet, ducted outlet. Ratings include the effects of duct end correction.

KTF2240 / RB40 / H / 12-7V (Forward)

875 rpm - 60 Hz

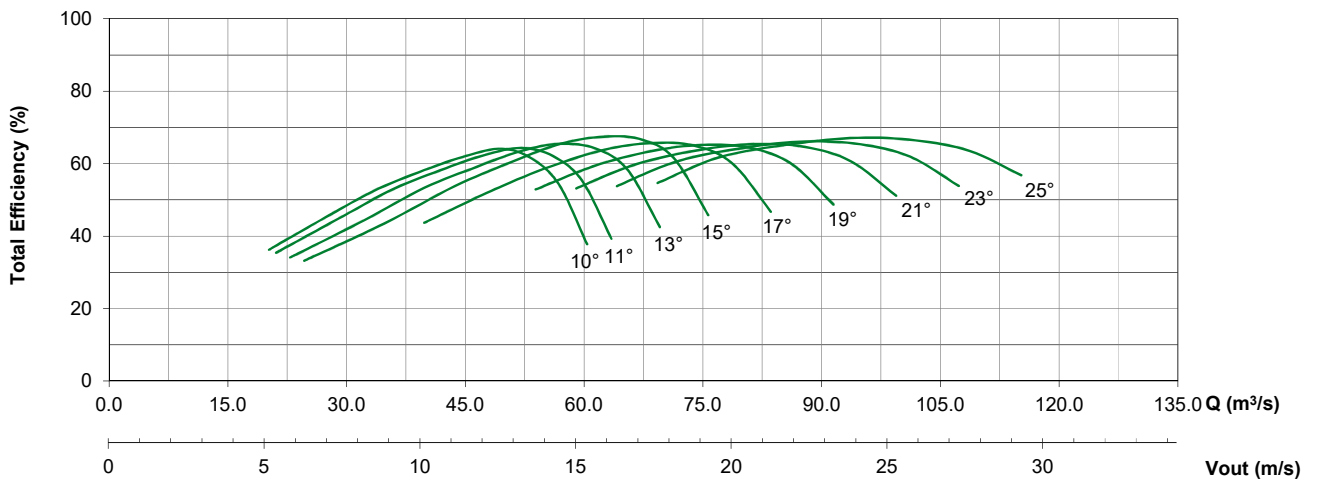
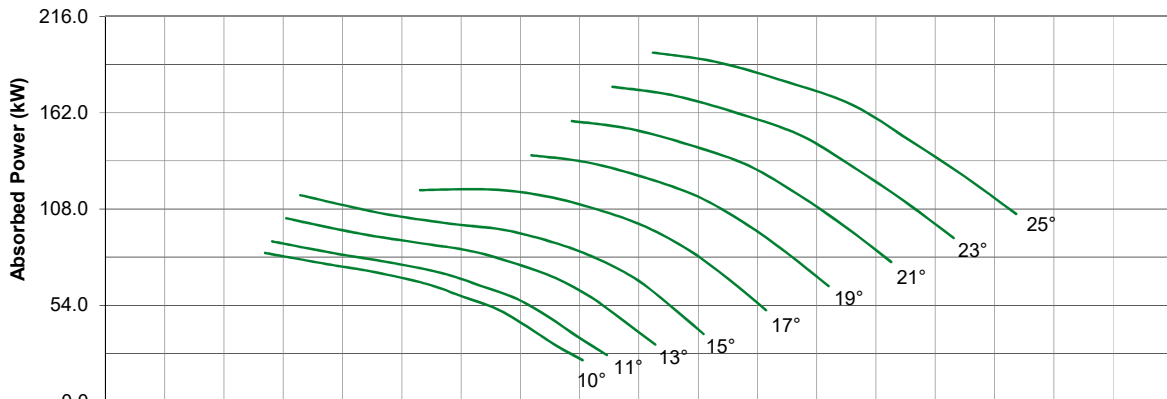
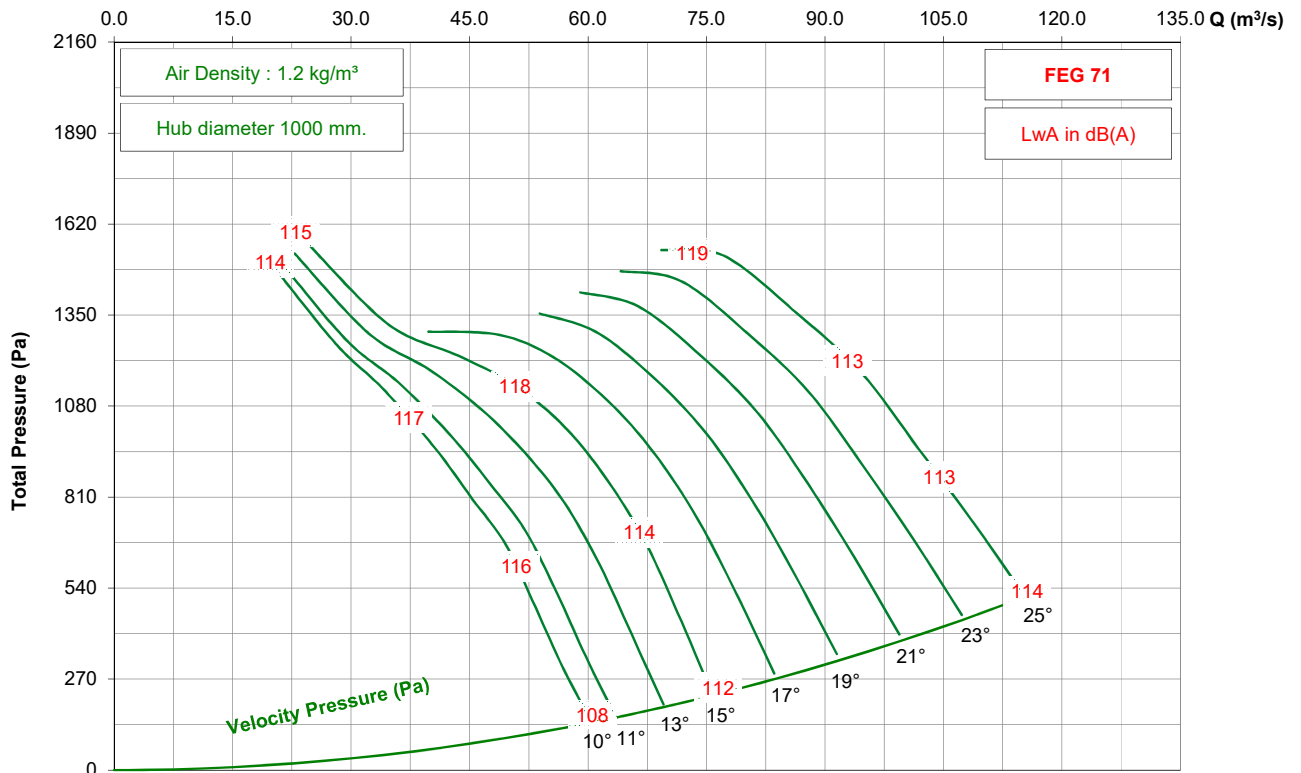

- Performance certified is for installation type D - ducted inlet, ducted outlet. Performance ratings do not include the effects of appurtenances (accessories).
 - The A-weighted sound ratings shown have been calculated per AMCA International Standard 301. Values shown are for inlet Lwi(A) sound power levels for installation type D - ducted inlet, ducted outlet. Ratings include the effects of duct end correction.

KTF2240 / RB40 / H / 12-7V (Reverse)

950 rpm - 50 Hz

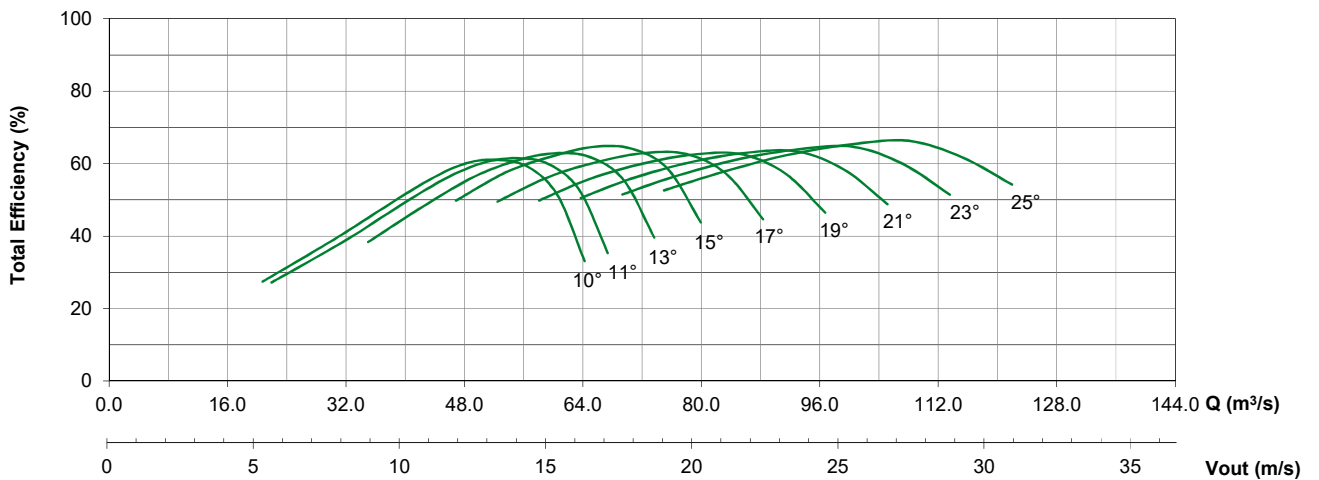
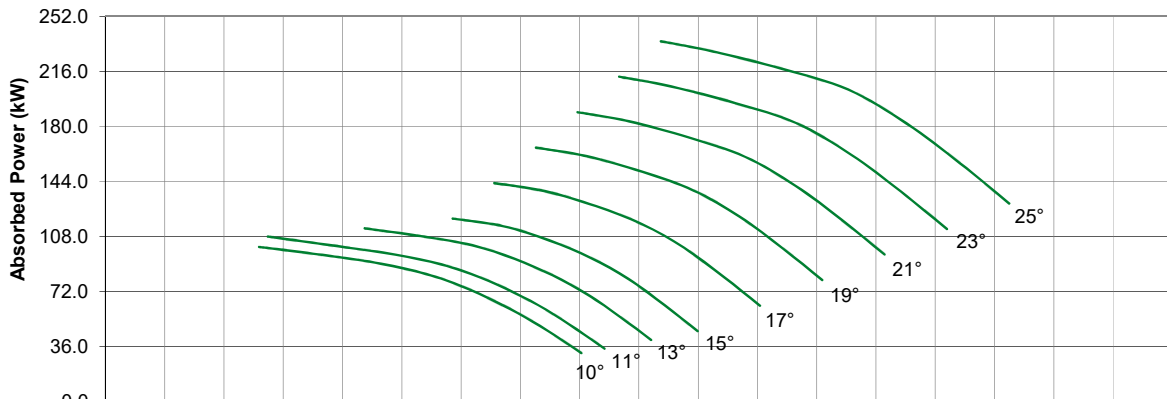
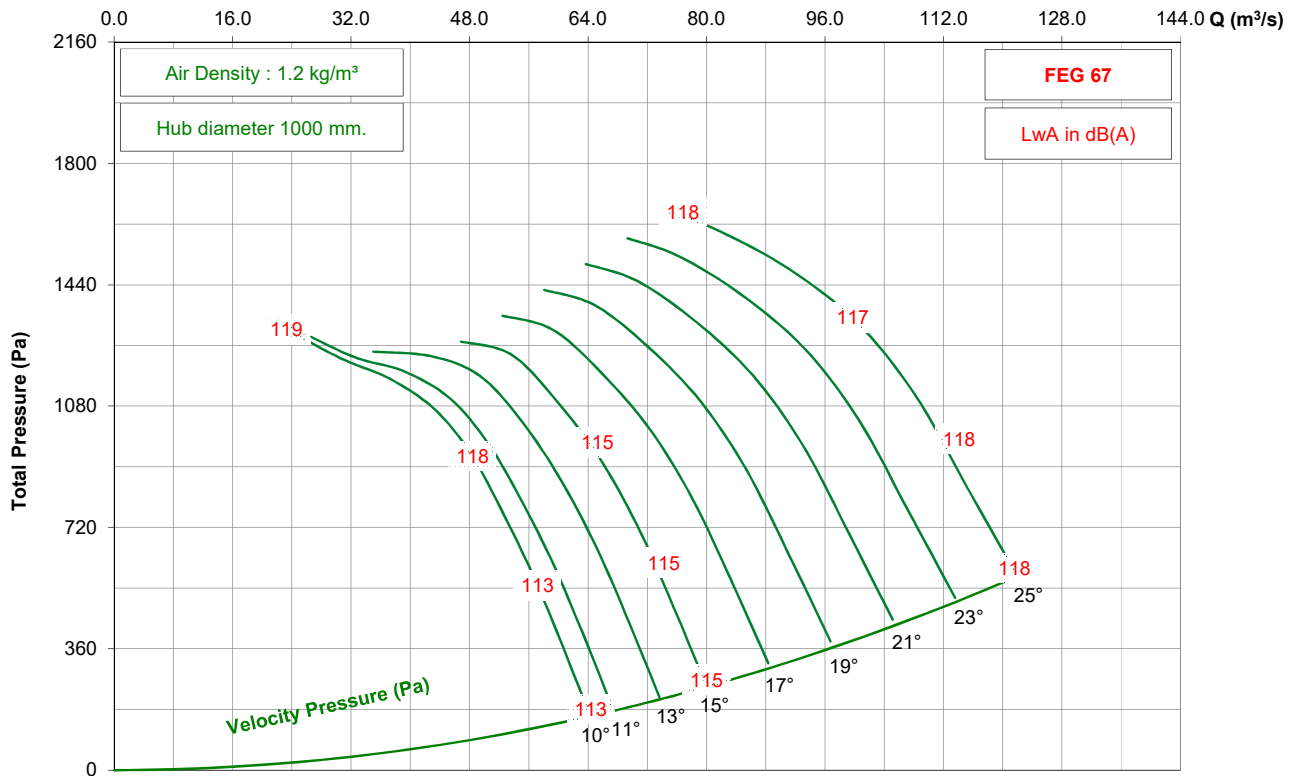

- Performance certified is for installation type D - ducted inlet, ducted outlet. Performance ratings do not include the effects of appurtenances (accessories).
 - The A-weighted sound ratings shown have been calculated per AMCA International Standard 301. Values shown are for inlet Lwi(A) sound power levels for installation type D - ducted inlet, ducted outlet. Ratings include the effects of duct end correction.

KTF2240 / RB40 / H / 12-7V (Reverse)

725 rpm - 50 Hz

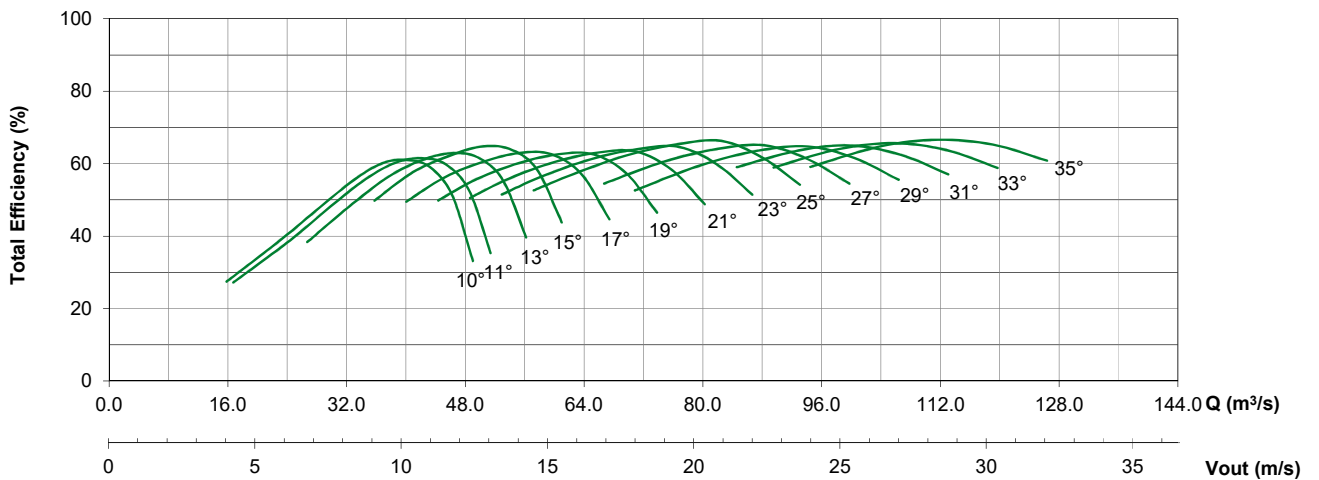
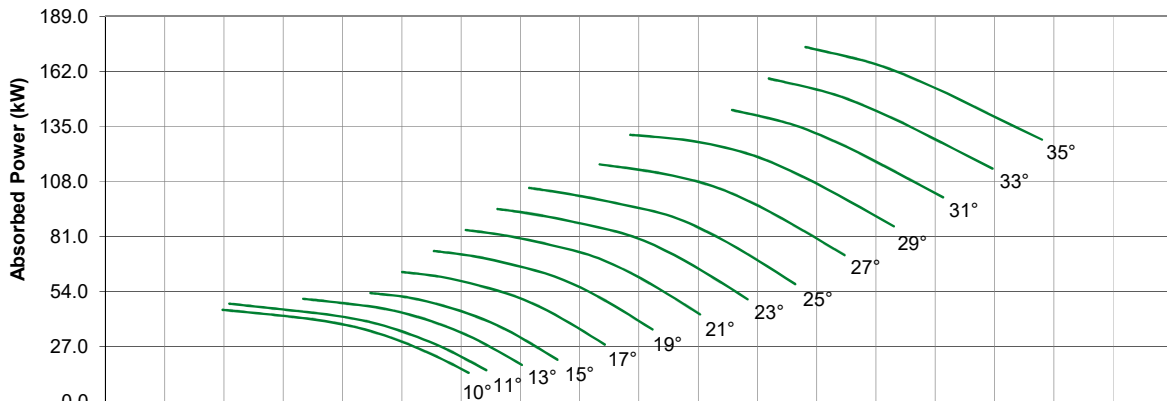
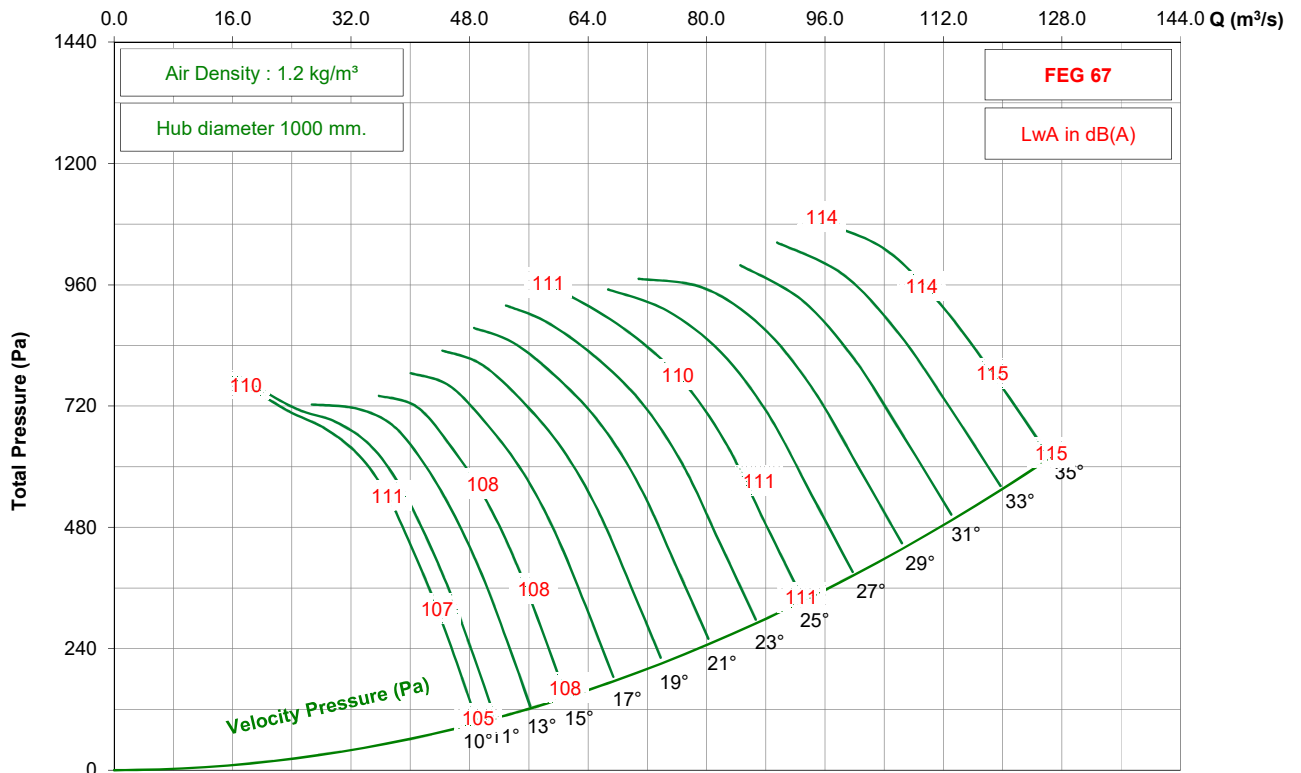

- Performance certified is for installation type D - ducted inlet, ducted outlet. Performance ratings do not include the effects of appurtenances (accessories).
 - The A-weighted sound ratings shown have been calculated per AMCA International Standard 301. Values shown are for inlet Lwi(A) sound power levels for installation type D - ducted inlet, ducted outlet. Ratings include the effects of duct end correction.

KTF2240 / RB40 / H / 12-7V (Reverse)

875 rpm - 60 Hz

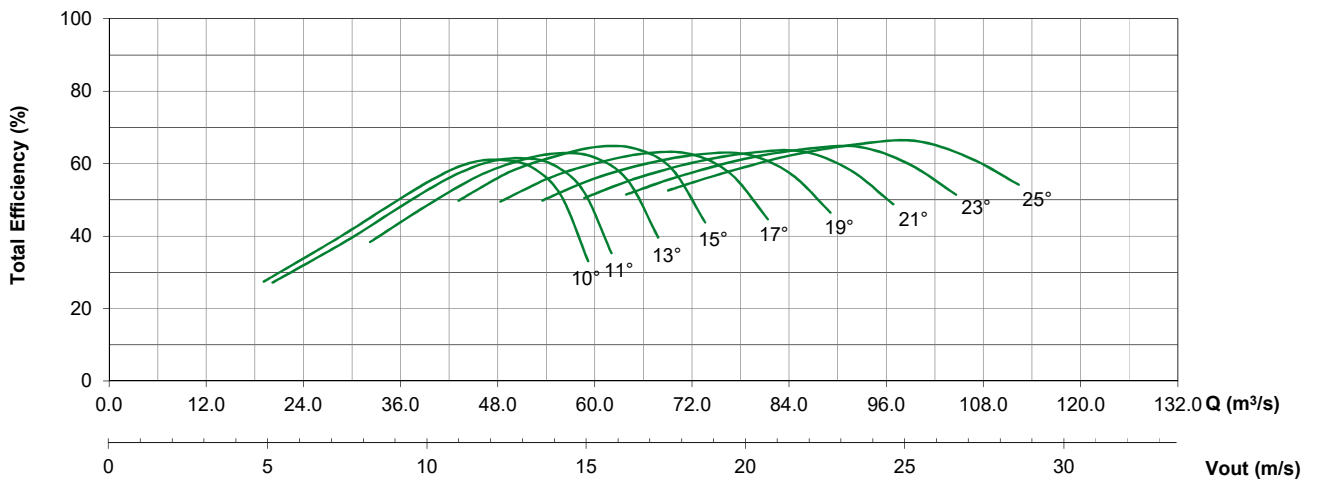
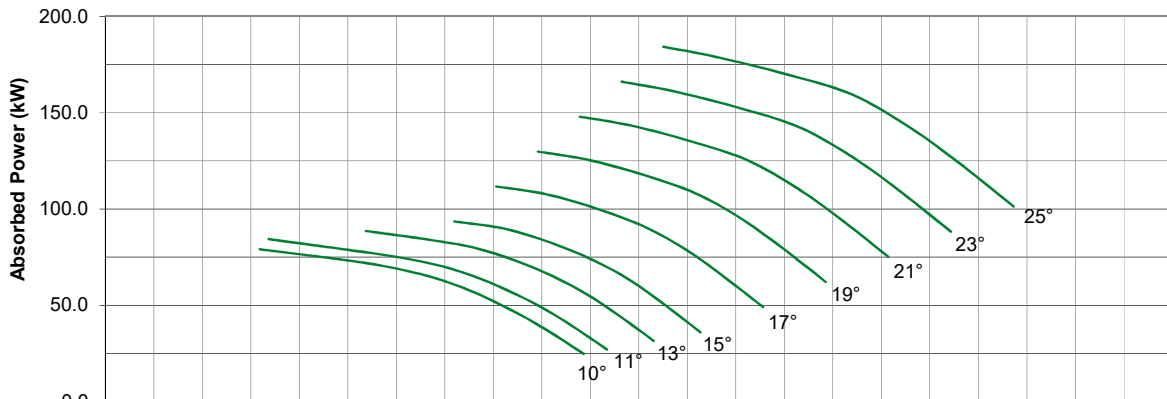
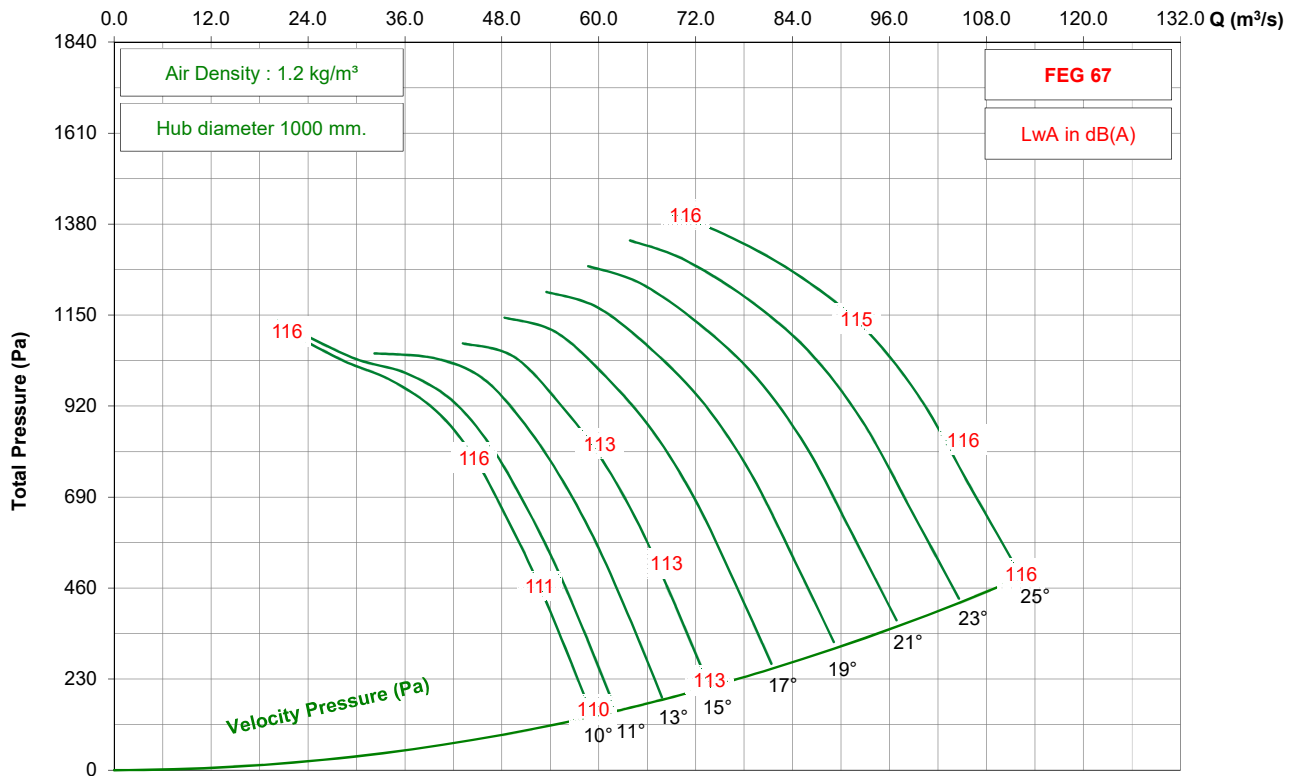

- Performance certified is for installation type D - ducted inlet, ducted outlet. Performance ratings do not include the effects of appurtenances (accessories).
 - The A-weighted sound ratings shown have been calculated per AMCA International Standard 301. Values shown are for inlet Lwi(A) sound power levels for installation type D - ducted inlet, ducted outlet. Ratings include the effects of duct end correction.

KRUGER GROUP (VENTILATION)

• THAILAND (Regional HQ)

KRUGER VENTILATION INDUSTRIES ASIA CO. LTD.

30/159 Moo 1, Sinsakorn Industrial Estate,
Chetsadawithi Road, Khok Kham Mueng, Samuthsakorn 74000, Thailand
Tel. +662 1054298 - Fax +662 0248256-9
Website: www.krugerfan.com

• CHINA (BEIJING)

BEIJING KRUGER VENTILATION CO. LTD

Level 7, A Block, Rising International Building, 29 JingHai San Road, BDA,
Beijing, P.R.China 100176
Tel. +86 10-67881366 - Fax +86 10-67880566
Email: krugertj@krugertj.com

• CHINA (SHANGHAI)

SHANGHAI KRUGER VENTILATION CO. LTD

No. 500 Yuanguo Road, Anting, Jiading,
Shanghai 201814 P.R. China
Tel. +86 21-69573266 - Fax +86 21-69573296
Email: shkruger@krugerchina.com

• CHINA (WUHAN)

WUHAN KRUGER VENTILATION CO. LTD

No. 805, Huian Ave, Dongxihu District, Wuhan, Hubei, P.R. China 430000
Tel. +86 27- 83248840/83060522/83097505
Fax +86 27- 83261886
Email: whkruger@krugerwh.com

• HONG KONG

KRUGER VENTILATION (HONG KONG) LIMITED

Flat C, 9/F, Yeung Yiu Chung (No.8) Industrial Building,
20 Wang Hoi Road, Kowloon Bay, Kowloon, Hong Kong
Tel. +852 22469182 - Fax +852 22469187
Email: info@kruger.com.hk

• INDIA (NORTH)

KRUGER VENTILATION INDUSTRIES (NORTH INDIA) PVT LTD

Plot No. - 191, Sector - 59, Ballabgarh, Faridabad - 121 004, Haryana, India
Tel. +91-9958991660/9717449696
Fax. +91-1294135820
Email: sales.kni@krugerindia.com

• KOREA

NEOMATE CO. LTD

2-1010, Ace High Tech City B/D, 775 Gyeongin-ro,
Yeongdeungpo-gu, Seoul, Korea. Postal Code 07299
Tel. +82-2-2679-2052 - Fax. +82-2-2679-2174
Email: y7890@neomate.co.kr

• MYANMAR

KRUGER VENTILATION (MYANMAR) CO.LTD

Room No. F21, Thiri Yadanar Whole Sale Market, (Htawunbe)
Toe Chae Ward, North Okkalapa Township, Yangon.
Tel. +959 763141081/2/3
Email: htoon@krugermm.com

• SINGAPORE

KRUGER ENGINEERING PTE LTD

No. 10 Buroh Street #06-06, West Connect Building,
Singapore 627564
Tel. +65 68631191 - Fax +65 68631151
Email: mktg@krugerasia.com

• THAILAND

KRUGER VENTILATION IND. (THAILAND) CO. LTD

30/105 Moo 1, Sinsakorn Industrial Estate,
Chetsadawithi Road, Khok Kham Mueng, Samuthsakorn 74000, Thailand
Tel. +662 1050399 - Fax + 662 1050370-2
Email: mktg@kruger.co.th

• AUSTRALIA

S&P-KRUGER AUSTRALIA PTY LTD

2 Cunningham St, Moorebank N.S.W. 2170
Tel. +61 2-98227747
Fax. +61 2-98227757
Email: info@sandpkruger.com.au

• CHINA (GUANGZHOU)

GUANGZHOU KRUGER VENTILATION CO. LTD

No. 9 Huahui Road, Huashan, Huadu,
Guangzhou, P.R. China 510880
Tel. +86 20-66356635 - Fax +86 20-86786001/86786500
Email: gzkruger@krugergz.com

• CHINA (TIANJIN)

TIANJIN KRUGER VENTILATION CO. LTD

No.168 Anyuan Road, Jingjin Science and Technology Park
Wuqing District, Tianjin, China
Tel. +86 22-22143480/3481 - Fax +86 22-22143482
Email: krugertj@krugertj.com

• DUBAI

KRUGER VENTILATION INDUSTRIES, GULF BRANCH

Jebel Ali Free Zone Area (JAFZA) P.O. Box No. 262949, Dubai, UAE
Tel. +971 4 8819188/8832017
Fax. +971 4 8832018
Email: johncs@krugerasia.com

• INDIA

KRUGER VENTILATION INDUSTRIES (INDIA) PVT LTD

Kruger Centre, Mumbai-Nasik Highway,
Kalamgaon, Shahapur, Thane 421601, Maharashtra, India
Tel. +91 9960558899/9975577211 - Fax +91 2527 240075
Email: sales@krugerindia.com

• INDONESIA

P.T. KRUGER VENTILATION INDONESIA

Jl. Teuku Umar No.20,
Karawaci - Tangerang 15115, Indonesia
Tel. +62 21-5512288/5513557 - Fax +62 21-5513502
Email: mktg@krugerindo.co.id

• MALAYSIA

KRUVENT INDUSTRIES (M) SDN BHD

Lot 850, Jalan Subang 7, Taman Perindustrian Subang,
47500, Subang Jaya, Selangor D.E.
Tel. +603 80743399 - Fax +603 80743388
Email: mktg@kruger.com.my

• PHILIPPINES

KRUGER M&E INDUSTRIES CORPORATION

FAP I Compound, E. Rodriguez Ave.
Tunasan, Muntinlupa City 1773, Philippines
Tel. +63 2-8622892/4/6/7, 5534059 - Fax +63 2-8622891
Email: mktg@krugerph.net

• TAIPEI

KRUGER VENTILATION (TAIWAN) CO. LTD

No. 157, Ping-an Rd, Hengfeng Village,
Dayuan Shiang Taoyuan County 337, Taiwan
Tel. +886 3-3859119 - Fax +886 3-3859118
Email: sales@krugertwn.com.tw

• VIETNAM

KRUGER VENTILATION INDUSTRIES (VIETNAM) CO. LTD

Lot A7. 2-4, C2 Road, Thanh Thanh Cong IZ,
Trang Bang Dist. Tay Ninh Province, Vietnam
Tel. +84-276 3585200/01/02 - Fax +84-276 3585199
Email: mktg@krugervn.com

The company is always improving and developing its products, therefore the company reserves the right of making changes to the illustrated products.
Certified dimension can be provided upon request.