

**KRUGER**



# **CABINET FAN**

## **CFC SERIES**



Compact



Flexible



Low Noise

## Why KRUGER ?

KRUGER has been a leading innovator and manufacturer of residential, commercial and industrial fan application solutions across Asia since 1985. Today with a direct presence in over 18 regions throughout Asia; world class R&D and manufacturing facilities; KRUGER are able to offer their customers unparalleled service and support at a local level. Our customers place their trust in KRUGER.



## What is a KRUGER Cabinet Fan ?

The CFC Series is a compact cabinet centrifugal fan is designed for supply, exhaust and pressurization in general clean air, grease laden air and smokespill application. It is compact, easy to install and service, generates high static pressure and low noise.

## Why use a KRUGER CFC Cabinet Fan ?

**Compact size** ►► **Close to duct size** ►► **Lower space requirement**

CFC Series compact sized cabinet is comparable to an axial fan but much smaller than a centrifugal fan.

**Flexible Installation** ►► **Suitable for any mounting orientation** ►► **Free to install anywhere along duct**

Cabinet with flexible inlet/outlet direction that can be changed in the field to suit any installation.

**Low noise** ►► **Optimised sound insulation cabinet** ►► **Installation near occupant**

KRUGER CFC Series offer one of the lowest noise /CMH in the industry allows for very flexible installation location even above occupants.

**Versatile design** ►► **Suitable for many ventilation applications** ►► **Installation friendly**

Suitable for the extract (or supply) of clean, grease laden or high temperature (up to F400) airstreams.

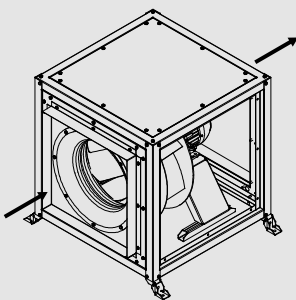

CFC Inline Discharge (180)

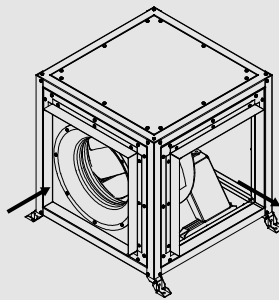

CFC Side Discharge (90)

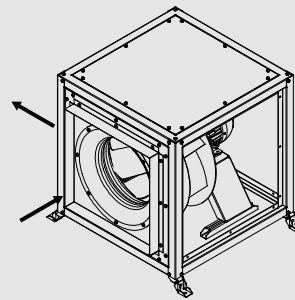

CFC Side Discharge (90)

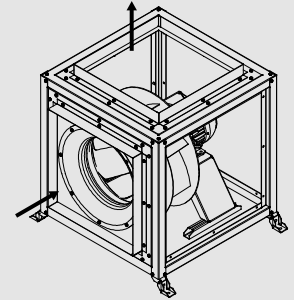

CFC Top Discharge (90)

## Summary of key standard CFC Series specifications:

- A- Nominal fan diameter sized from 315-1000mm.
- B- Airflow and static pressure performance range up to 45,000CMH and 1,000Pa.
- C- Airstream operating temperatures
  - Clean air standard ventilation application -20°C to +55°C.
  - Kitchen (grease laden air) application up to +80°C /176°F.
  - High temperature smokespill application (CFC-D) up to 400°C/2Hrs certified.
- D- Extended operating life.
  - Sealed bearings suitable for L10, >75,000 operating hours at maximum speed. Extended operating life construction of L10, >200,000 operating hours available upon request. Vibration balanced to G2.5 in accordance with ISO14694/AMCA 204 standards.

### E- Certifications.



Kruvent Industries (M) Sdn. Bhd. certifies that the CFC Series shown herein is licensed to bear the AMCA seal. The ratings shown are based on tests and procedures performed in accordance with AMCA Publication 211 and AMCA Publication 311 and comply with the requirements of the AMCA Certified Ratings Program.



High temperature (up to 400°C/2Hrs) in accordance with EN12101-3 certification by TÜV SÜD a third-party globally renowned testing and certification organisation.

Class	Temperature (°C)	Minimum functioning period (minutes)
F,250	250	120
F300	300	60
F,300	300	120
F400	400	120

### F- Cabinet

With high gloss surface finished manufactured from ZERO spange galvanized steel.

### G- Kruger's 3rd generation plenum backward curved wheel

Specifically optimized for high efficiency in an inline configuration. Wheel manufactured in steel finished in zinc rich primer and polyester powder coating with salt spray rating up to 1000 hours (ASTM B117). All wheels are statically and dynamically balanced to G2.5 (ISO 21940).

### H- High precision shaft

Belt drive shaft manufacture from C45 steel with g6 tolerance (ISO286-2), to minimize eccentricity of shaft leading to lower vibration and longer bearing life.

### I- Service friendly

Motor and drive outside casing and for easier belt adjustment and replacement.

### J- Built-in inlet and outlet flange for easy duct connection.

### K- High Efficiency KRUGER Motors

All CFC Series fans are supplied with a wide variety of both 1PH and 3PH AC, PM and EC, standard and high temperature rated motors. Please ask local KRUGER Distributor.

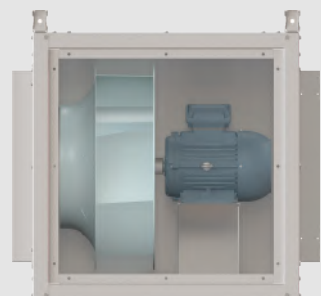
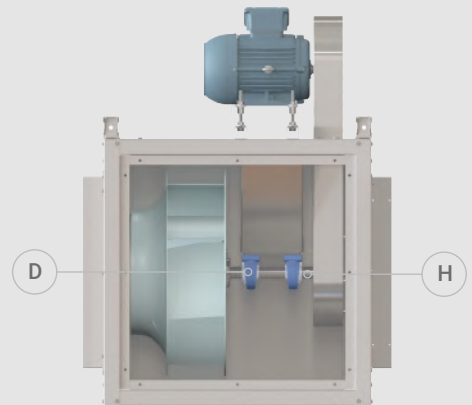
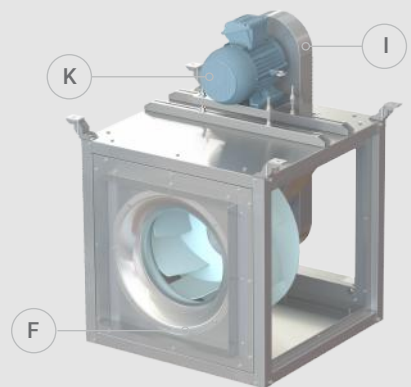
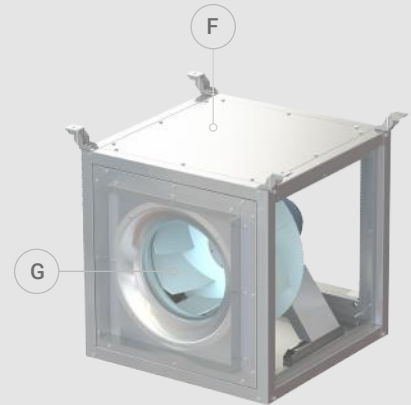

## Options and Accessories

- L- "Double skin" cabinet with acoustic and thermal insulation.
- M- Inlet and outlet safety guard.
- N- Flexible duct for normal and high temperature up to 400°C.
- O- Vibration isolator for ceiling hung or floor mounted installations.
- P- Spark resistance construction per AMCA 99.
- Q- Safety electrical switch.
- R- Belt cover isolates drive sets from airstream and protection from rotating pulleys and belts.
- S- Aluminium profile design, providing a high quality and great hardness.

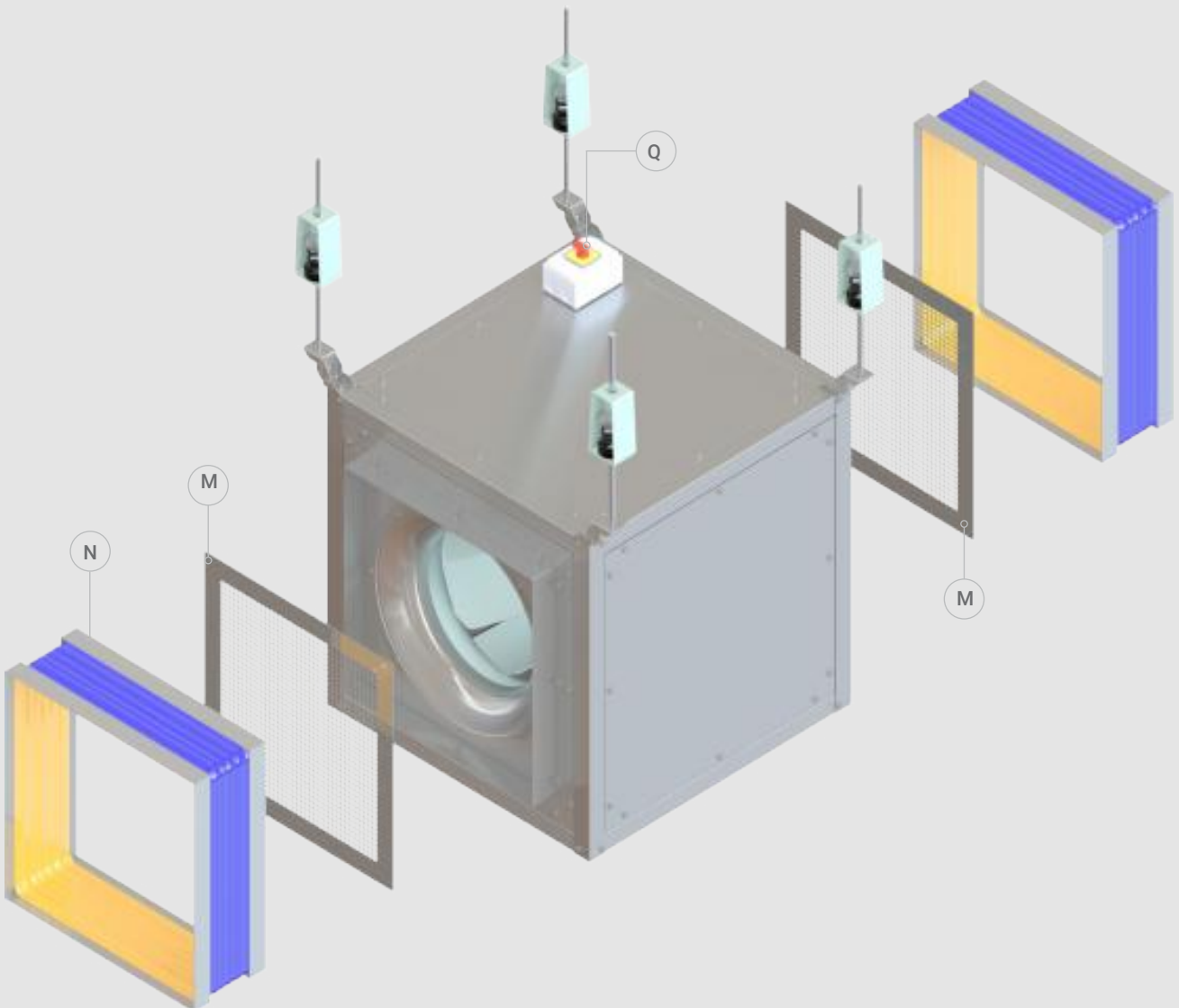

## Nomenclature

### CFC 450 - D - S - N

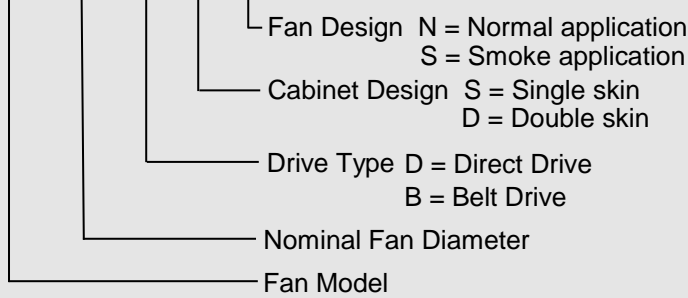

## Dimension

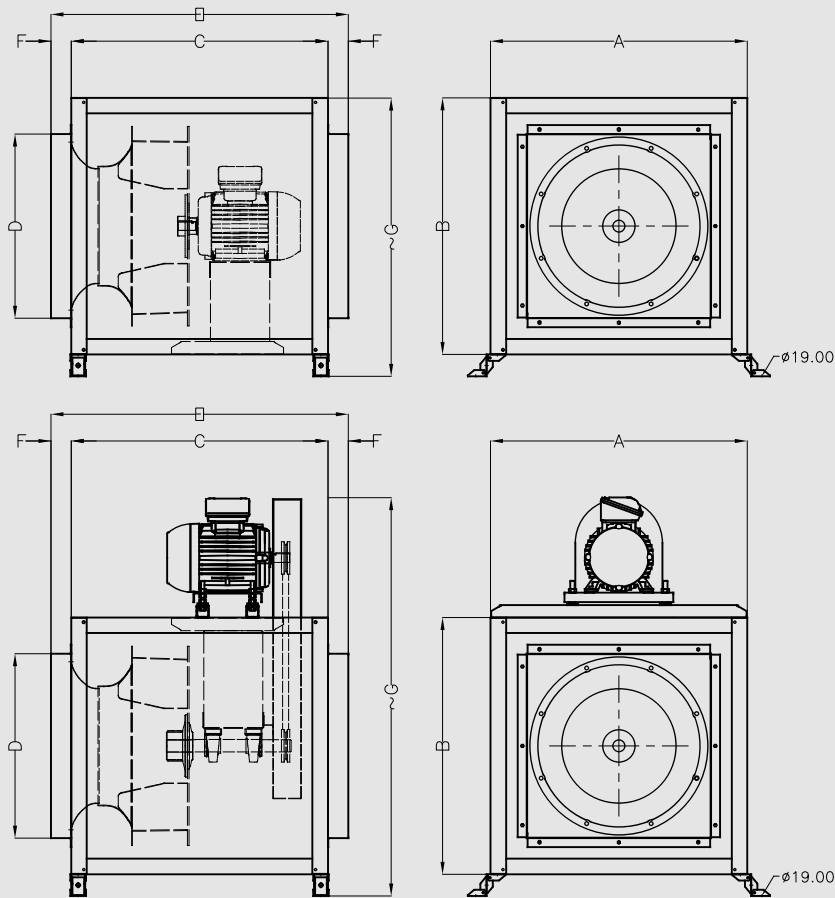

Model	A	B	C	D	E	F	G		Weight* (kg)	Max. Motor** Frame Size
							Direct Drive	Belt Drive		
CFC 315	475	475	585	354	715	65	515	845	63	90
CFC 355	525	525	655	388	785	65	565	895	78	90
CFC 400	585	585	735	432	868	65	625	975	90	100
CFC 450	655	655	655	470	887	65	695	1045	144	100
CFC 500	735	735	735	525	865	65	775	1155	154	112
CFC 560	825	825	825	590	955	65	865	1245	181	112
CFC 630	955	955	955	660	1085	65	1005	1440	212	132
CFC 710	1055	1055	1055	750	1185	65	1105	1540	272	132
CFC 800	1175	1175	1175	840	1305	65	1225	1660	320	132
CFC 900	1275	1275	1275	945	1405	65	1325	1865	340	160
CFC 1000	1455	1455	1455	1050	1610	65	1505	2045	480	160

\* Weight without motor and drive system.

\*\* Please consult KRUGER for details when motor frame size is beyond this range.

All dimension in mm.

### Example of Selection

Air Volume  $Q = 7710 \text{ m}^3/\text{h}$

Outlet Velocity  $V = 6.2 \text{ m/s}$

Dynamic Pressure  $P_d = 23.0 \text{ Pa}$

Total Pressure  $P_t = 730 \text{ Pa}$

Fan Speed  $N = 1450 \text{ rpm}$

Absorbed Power  $W = 2.5 \text{ kW}$

Total Efficiency  $\eta = 62 \%$

Sound Power Level  $L_w(A) = 83 \text{ dB(A)}$



### CFC 560 (90)

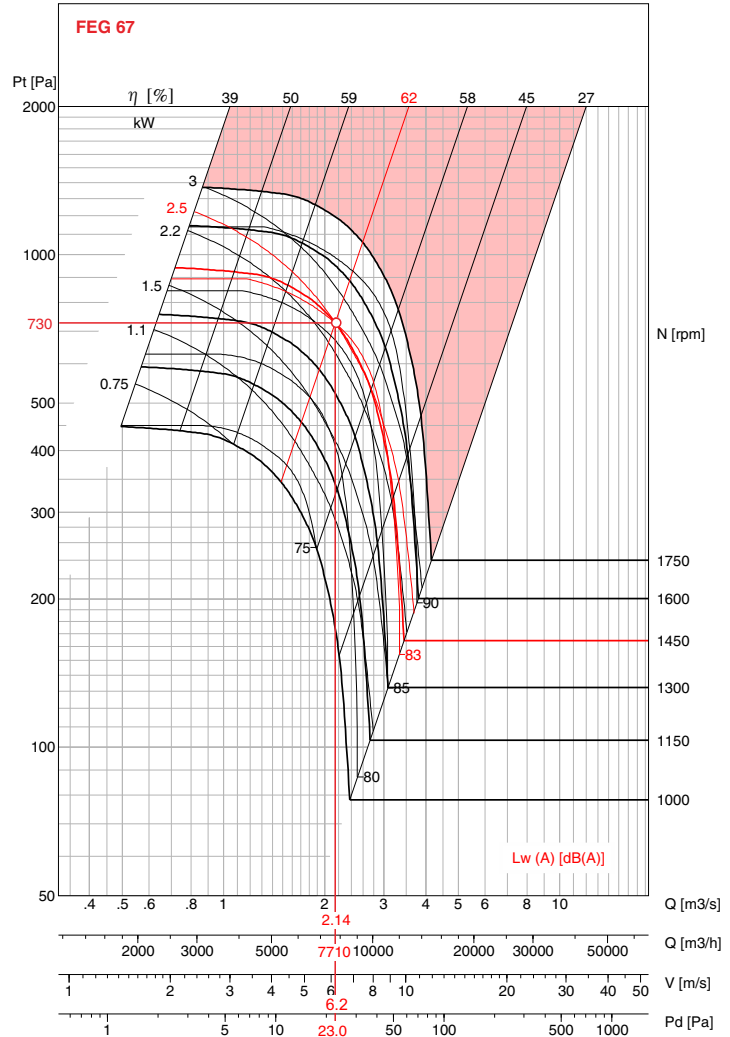

- Performance certified is for Installation type D - Ducted inlet, Ducted outlet. Performance ratings do not include the effects of appurtenances (belt cover). Power rating kW does not include transmission losses.  
 - The A-weighted sound ratings shown have been calculated per AMCA International Standard 301. Values shown are for inlet Lw(A) sound power levels for installation type D - Ducted inlet, Ducted outlet. Ratings include the effects of duct end correction.



# CFC 315 (90)

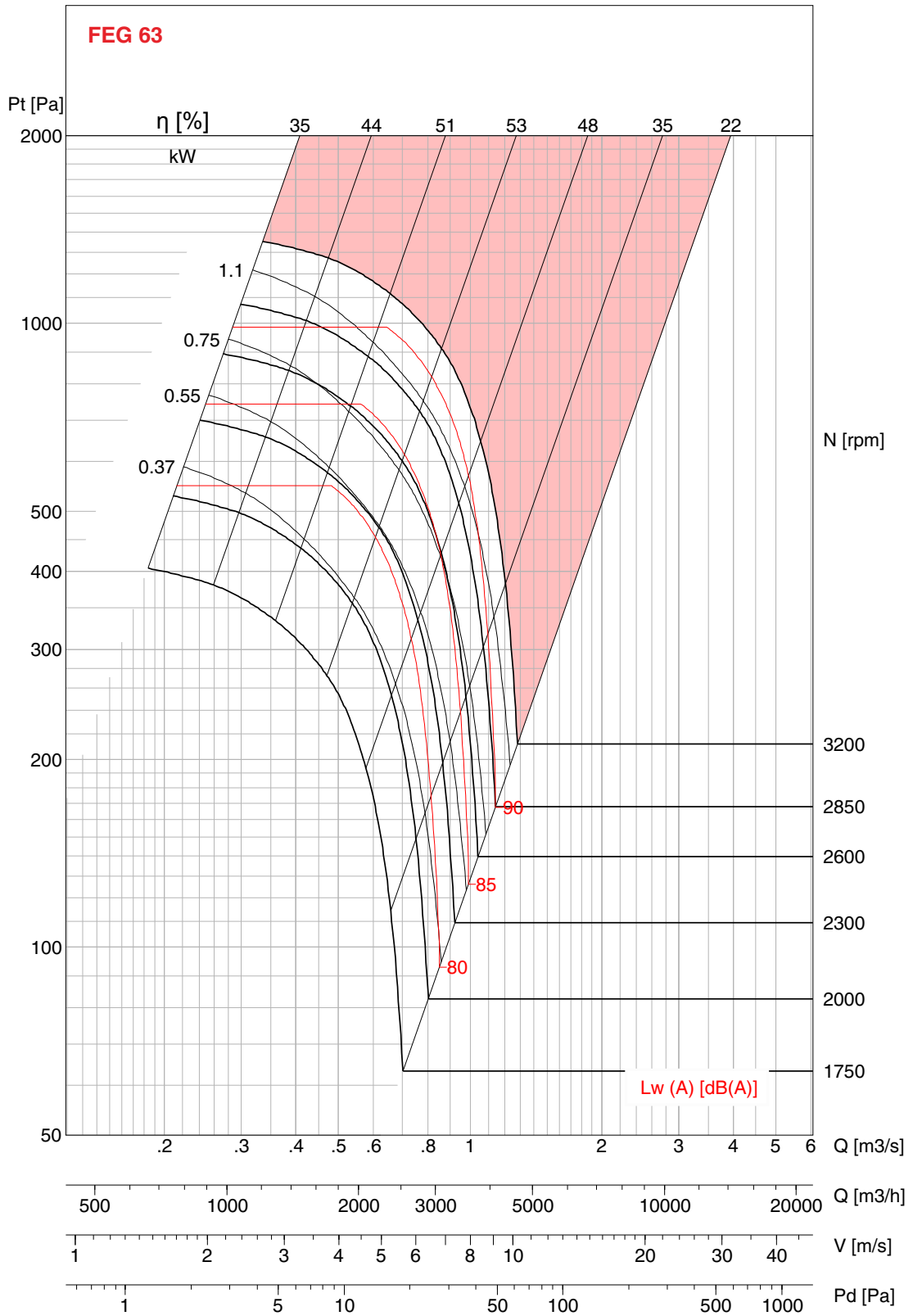

- Performance certified is for Installation type D - Ducted inlet, Ducted outlet. Performance ratings do not include the effects of appurtenances (belt cover). Power rating kW does not include transmission losses.  
 - The A-weighted sound ratings shown have been calculated per AMCA International Standard 301. Values shown are for inlet Lw (A) sound power levels for installation type D - Ducted inlet, Ducted outlet. Ratings include the effects of duct end correction.



# CFC 355 (90)

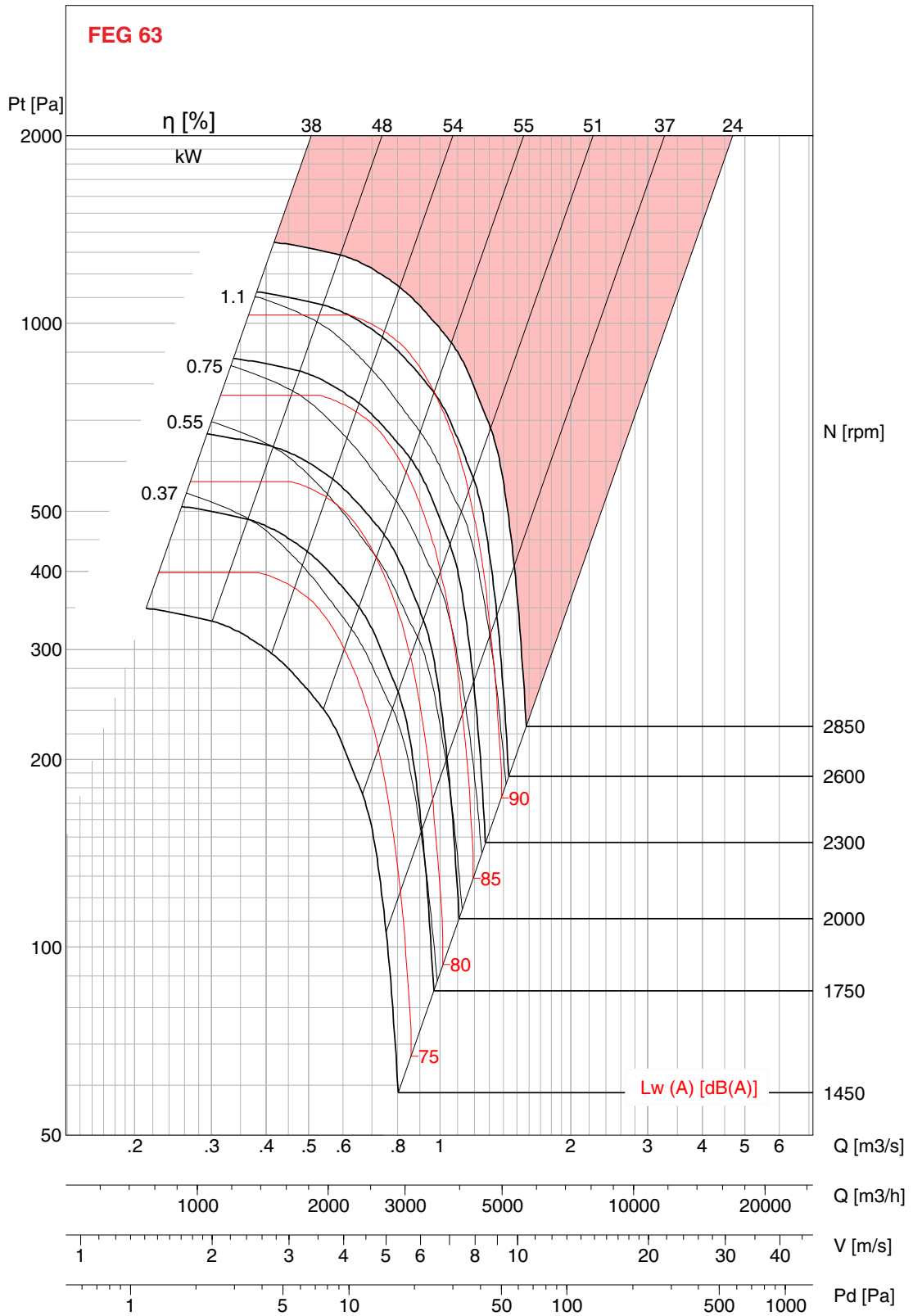

- Performance certified is for Installation type D - Ducted inlet, Ducted outlet. Performance ratings do not include the effects of appurtenances (belt cover). Power rating kW does not include transmission losses.  
- The A-weighted sound ratings shown have been calculated per AMCA International Standard 301. Values shown are for inlet Lw (A) sound power levels for installation type D - Ducted inlet, Ducted outlet. Ratings include the effects of duct end correction.





# CFC 400 (90)

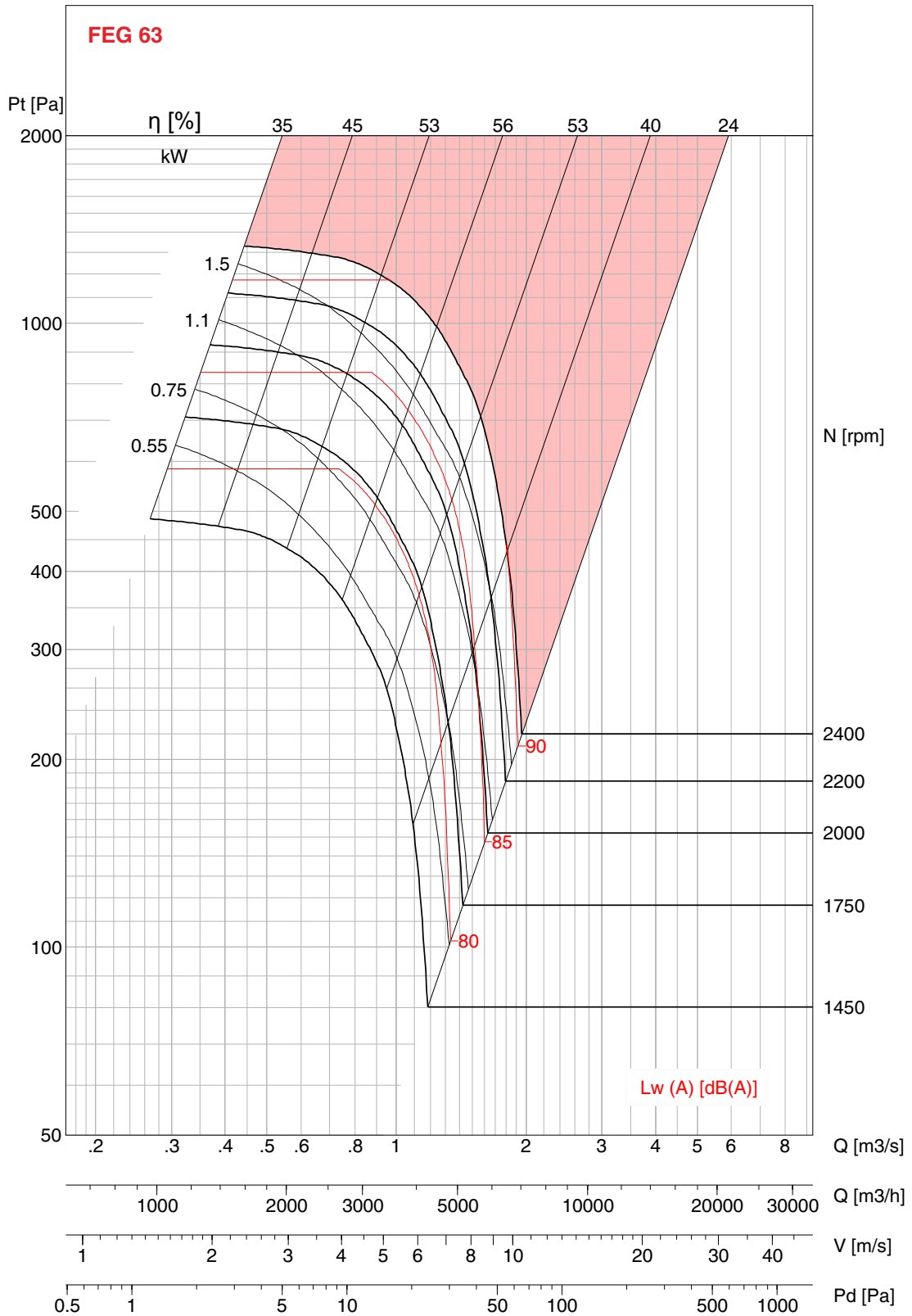

- Performance certified is for Installation type D - Ducted inlet, Ducted outlet. Performance ratings do not include the effects of appurtenances (belt cover). Power rating kW does not include transmission losses.  
- The A-weighted sound ratings shown have been calculated per AMCA International Standard 301. Values shown are for inlet Lw (A) sound power levels for installation type D - Ducted inlet, Ducted outlet. Ratings include the effects of duct end correction.



# CFC 450 (90)

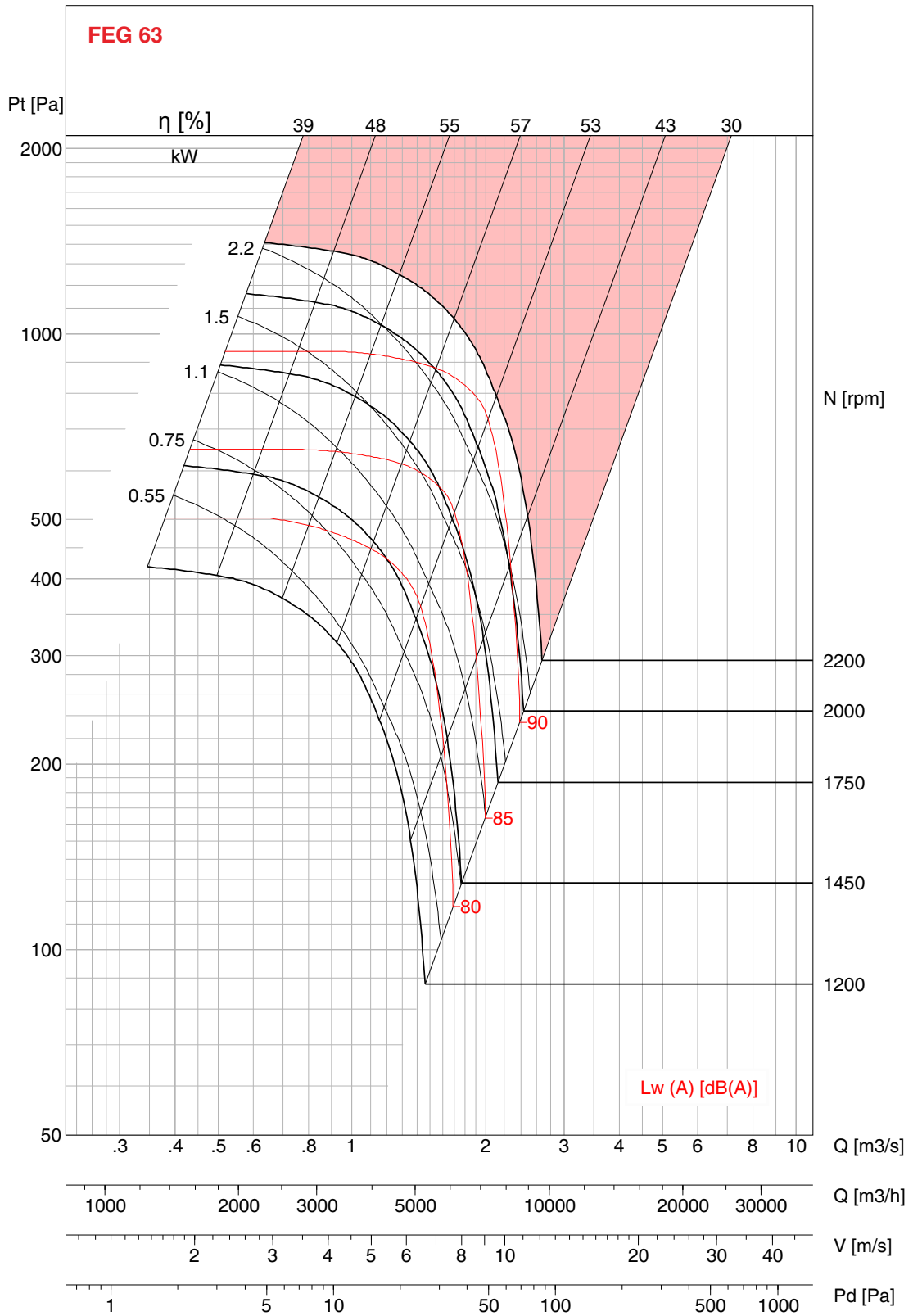

- Performance certified is for Installation type D - Ducted inlet, Ducted outlet. Performance ratings do not include the effects of appurtenances (belt cover). Power rating kW does not include transmission losses.  
 - The A-weighted sound ratings shown have been calculated per AMCA International Standard 301. Values shown are for inlet Lw (A) sound power levels for installation type D - Ducted inlet, Ducted outlet. Ratings include the effects of duct end correction.



# CFC 500 (90)

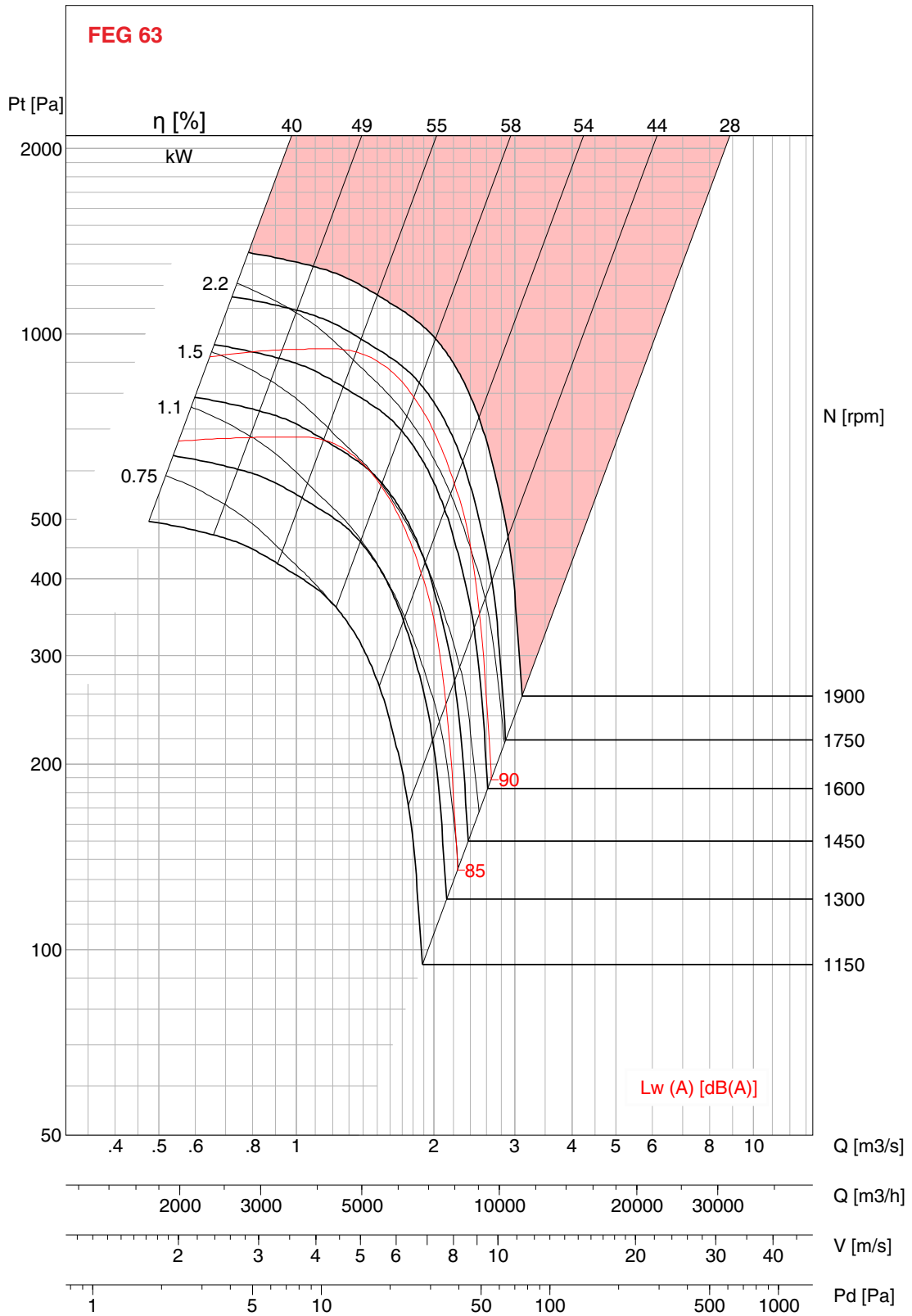

- Performance certified is for Installation type D - Ducted inlet, Ducted outlet. Performance ratings do not include the effects of appurtenances (belt cover). Power rating kW does not include transmission losses.  
 - The A-weighted sound ratings shown have been calculated per AMCA International Standard 301. Values shown are for inlet Lw (A) sound power levels for installation type D - Ducted inlet, Ducted outlet. Ratings include the effects of duct end correction.



# CFC 560 (90)

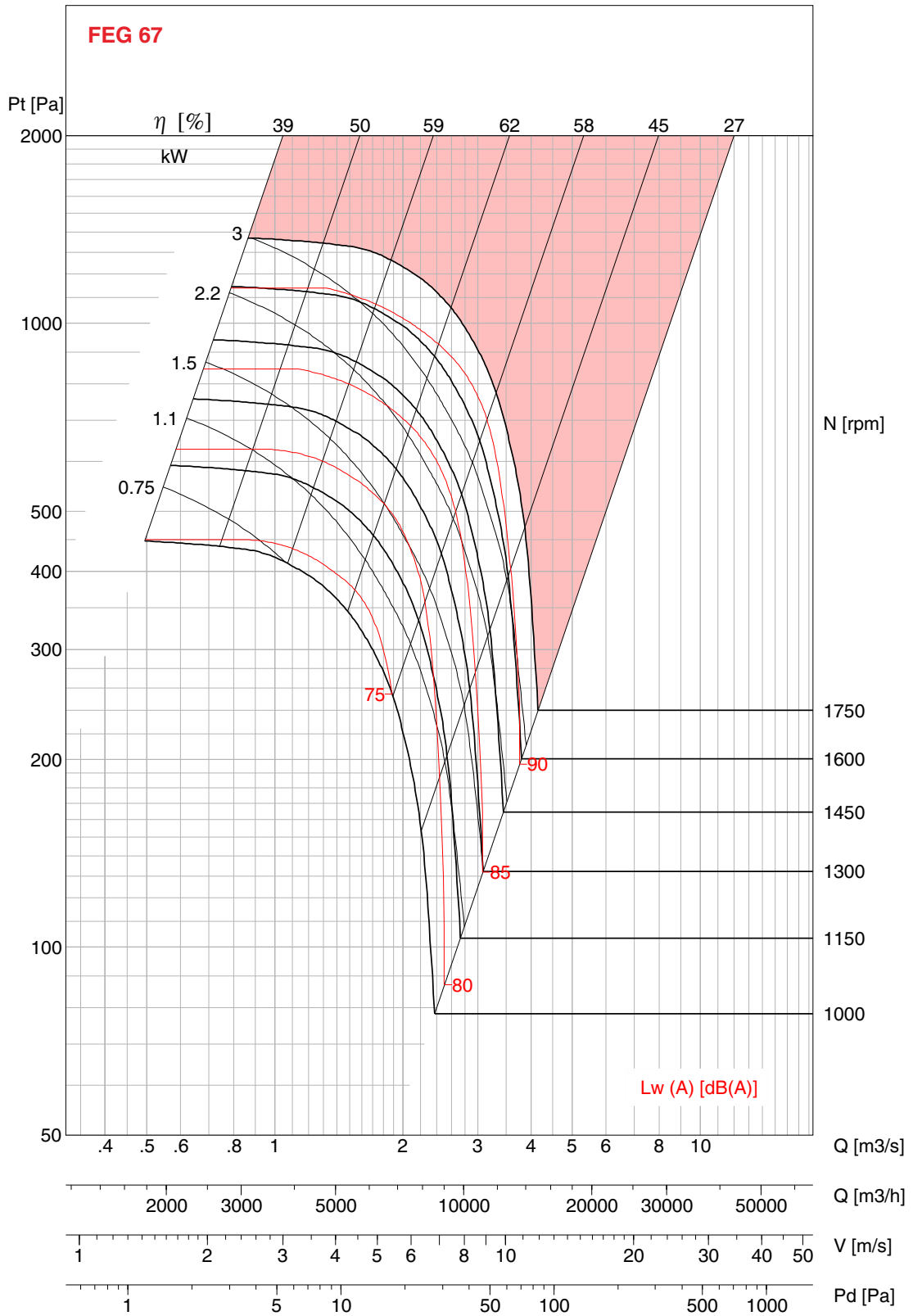

- Performance certified is for Installation type D - Ducted inlet, Ducted outlet. Performance ratings do not include the effects of appurtenances (belt cover). Power rating kW does not include transmission losses.  
 - The A-weighted sound ratings shown have been calculated per AMCA International Standard 301. Values shown are for inlet Lw(A) sound power levels for installation type D - Ducted inlet, Ducted outlet. Ratings include the effects of duct end correction.



# CFC 630 (90)

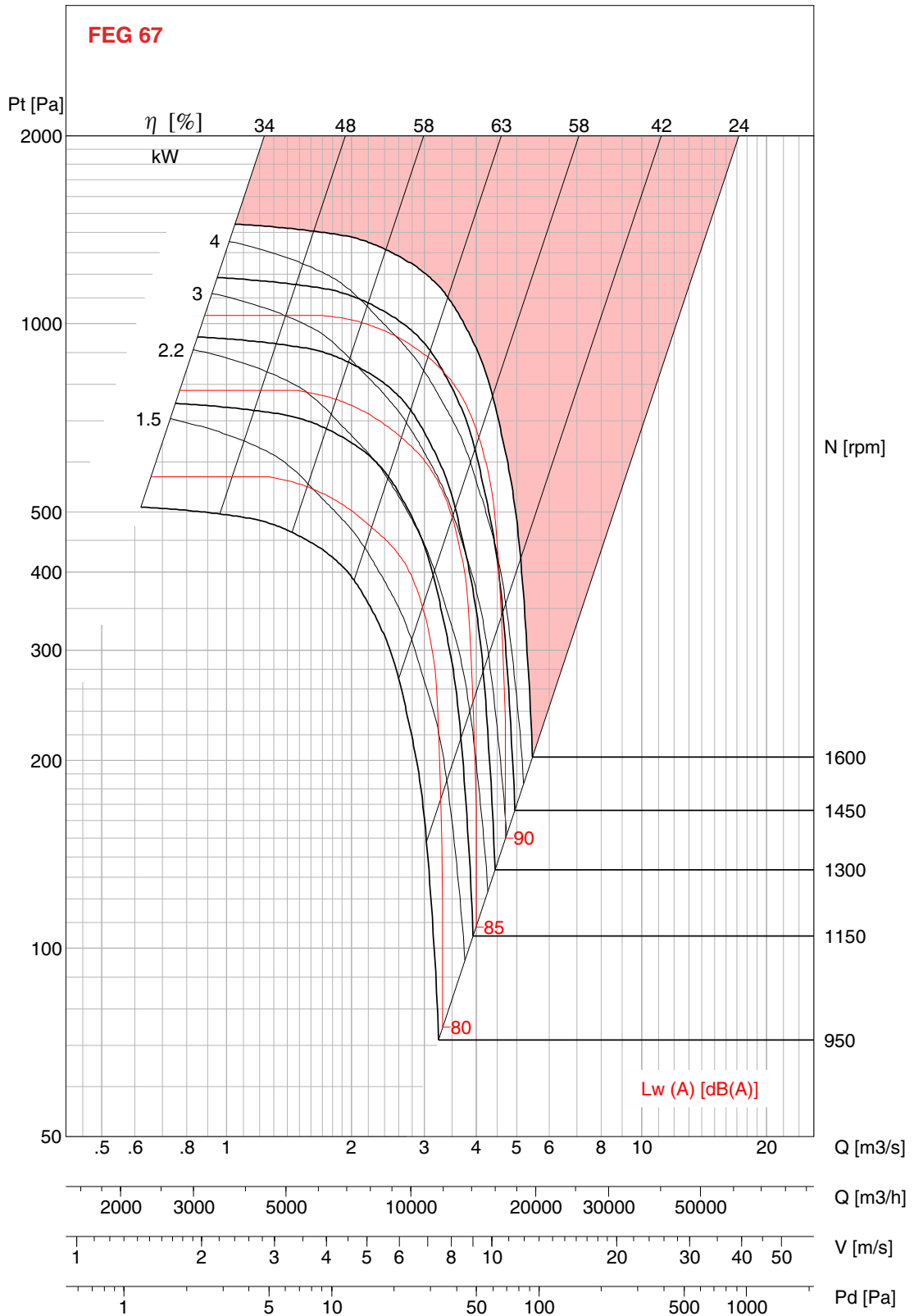

- Performance certified is for Installation type D - Ducted inlet, Ducted outlet. Performance ratings do not include the effects of appurtenances (belt cover). Power rating kW does not include transmission losses.  
 - The A-weighted sound ratings shown have been calculated per AMCA International Standard 301. Values shown are for inlet Lwi (A) sound power levels for installation type D - Ducted inlet, Ducted outlet. Ratings include the effects of duct end correction.



# CFC 710 (90)

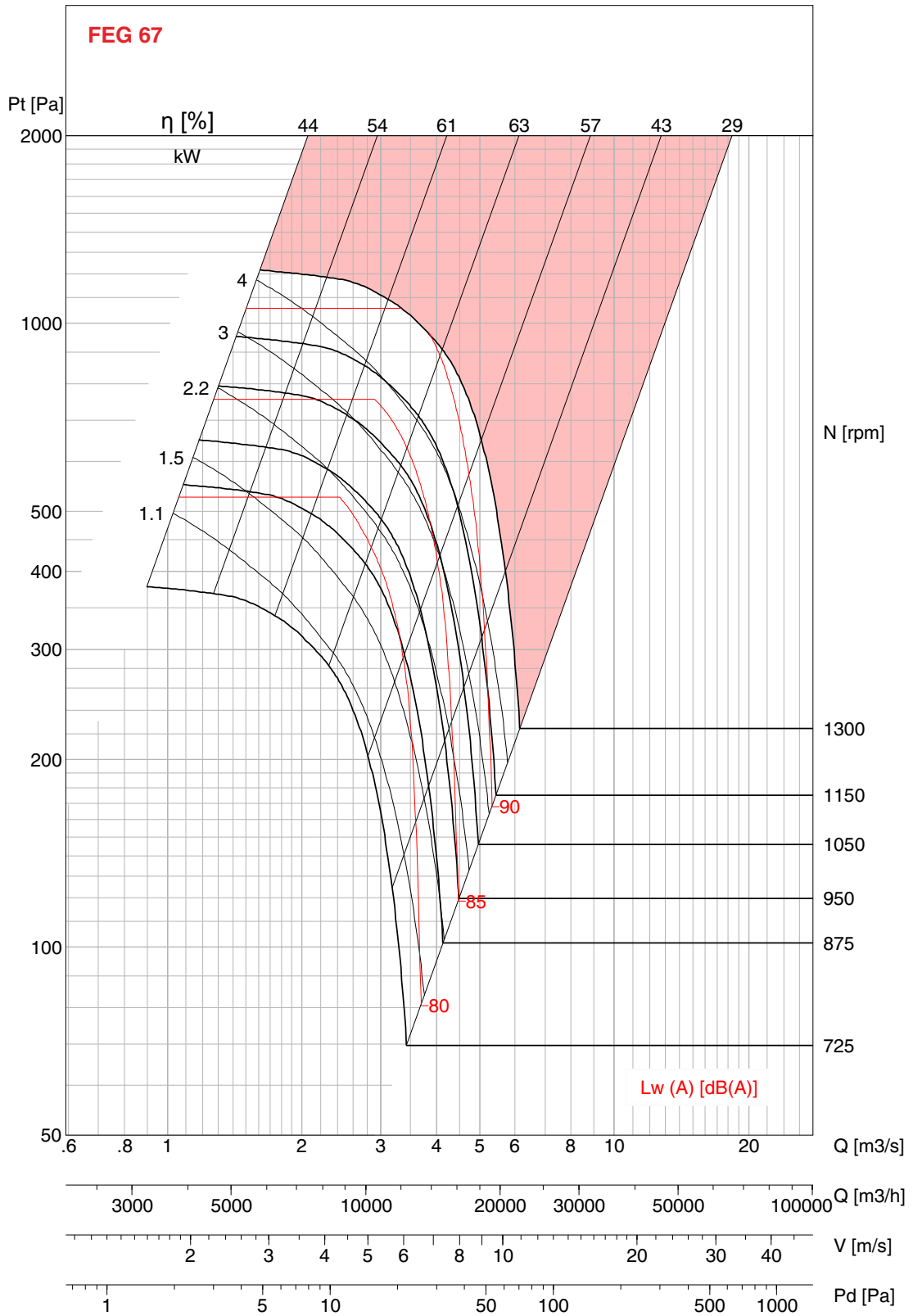

- Performance certified is for Installation type D - Ducted inlet, Ducted outlet. Performance ratings do not include the effects of appurtenances (belt cover). Power rating kW does not include transmission losses.  
 - The A-weighted sound ratings shown have been calculated per AMCA International Standard 301. Values shown are for inlet Lw(A) sound power levels for installation type D - Ducted inlet, Ducted outlet. Ratings include the effects of duct end correction.



# CFC 800 (90)

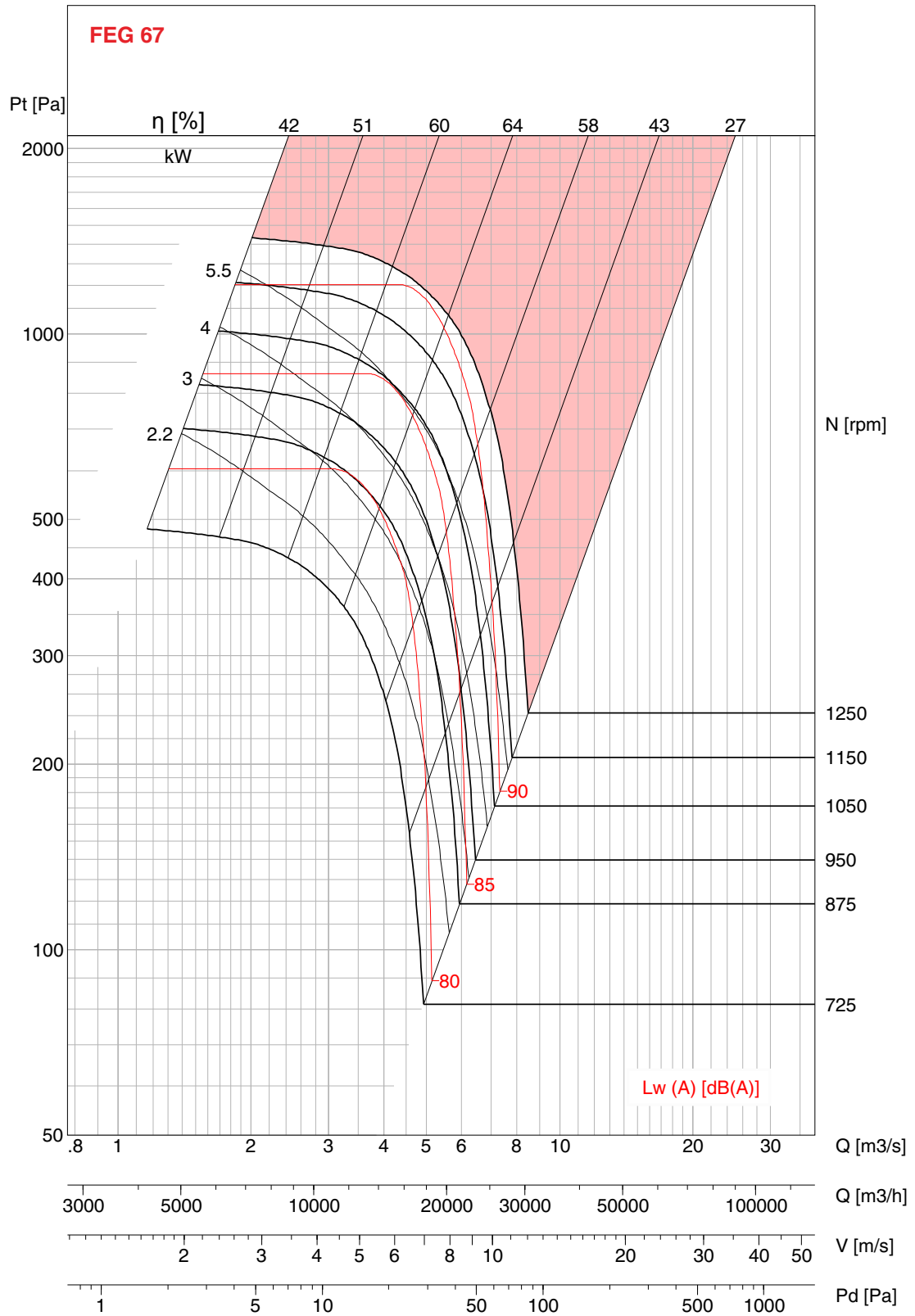

- Performance certified is for Installation type D - Ducted inlet, Ducted outlet. Performance ratings do not include the effects of appurtenances (belt cover). Power rating kW does not include transmission losses.  
 - The A-weighted sound ratings shown have been calculated per AMCA International Standard 301. Values shown are for inlet Lw (A) sound power levels for installation type D - Ducted inlet, Ducted outlet. Ratings include the effects of duct end correction.



# CFC 900 (90)

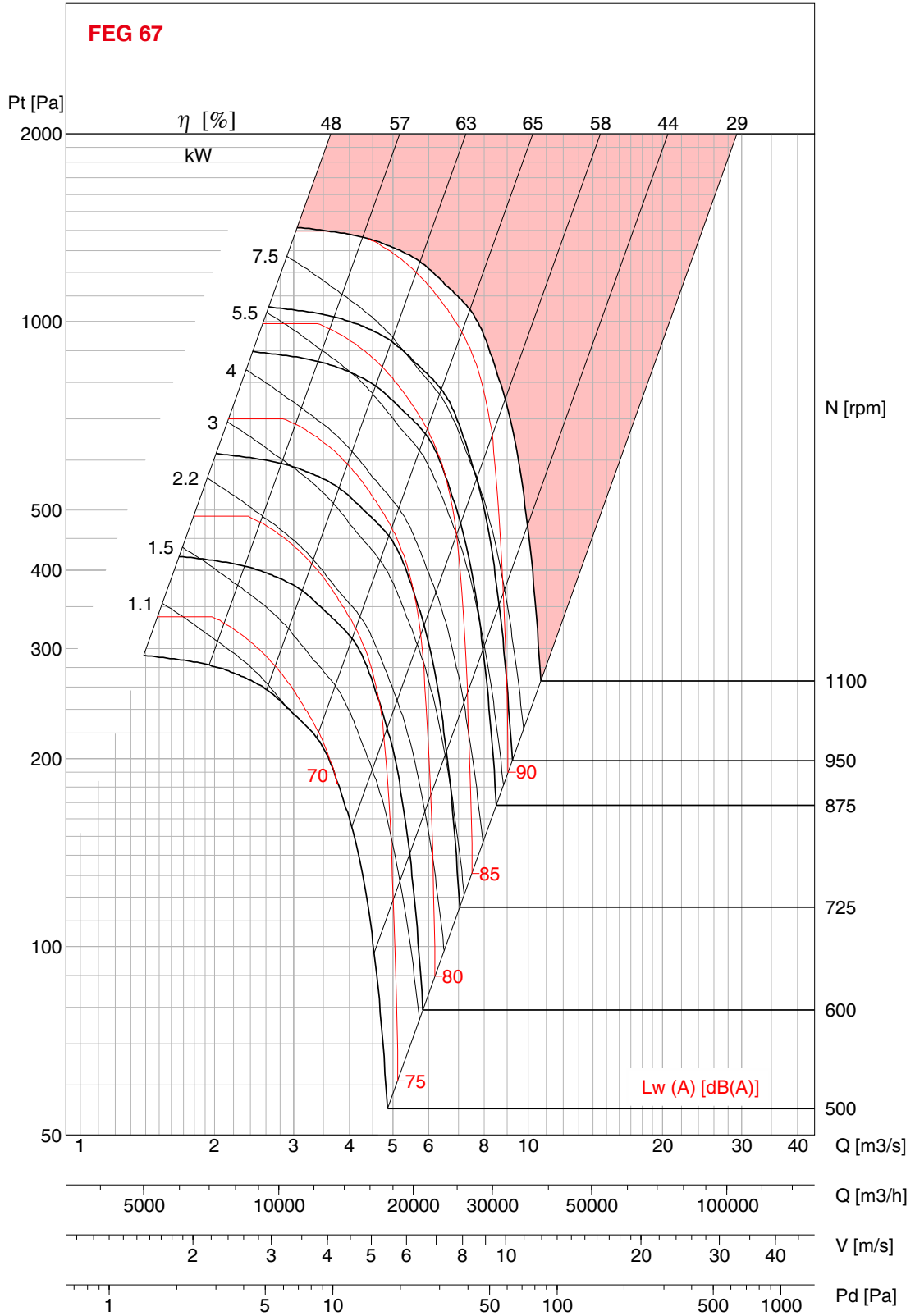

- Performance certified is for Installation type D - Ducted inlet, Ducted outlet. Performance ratings do not include the effects of appurtenances (belt cover). Power rating kW does not include transmission losses.  
 - The A-weighted sound ratings shown have been calculated per AMCA International Standard 301. Values shown are for inlet Lwi (A) sound power levels for installation type D - Ducted inlet, Ducted outlet. Ratings include the effects of duct end correction.





# CFC 1000 (90)

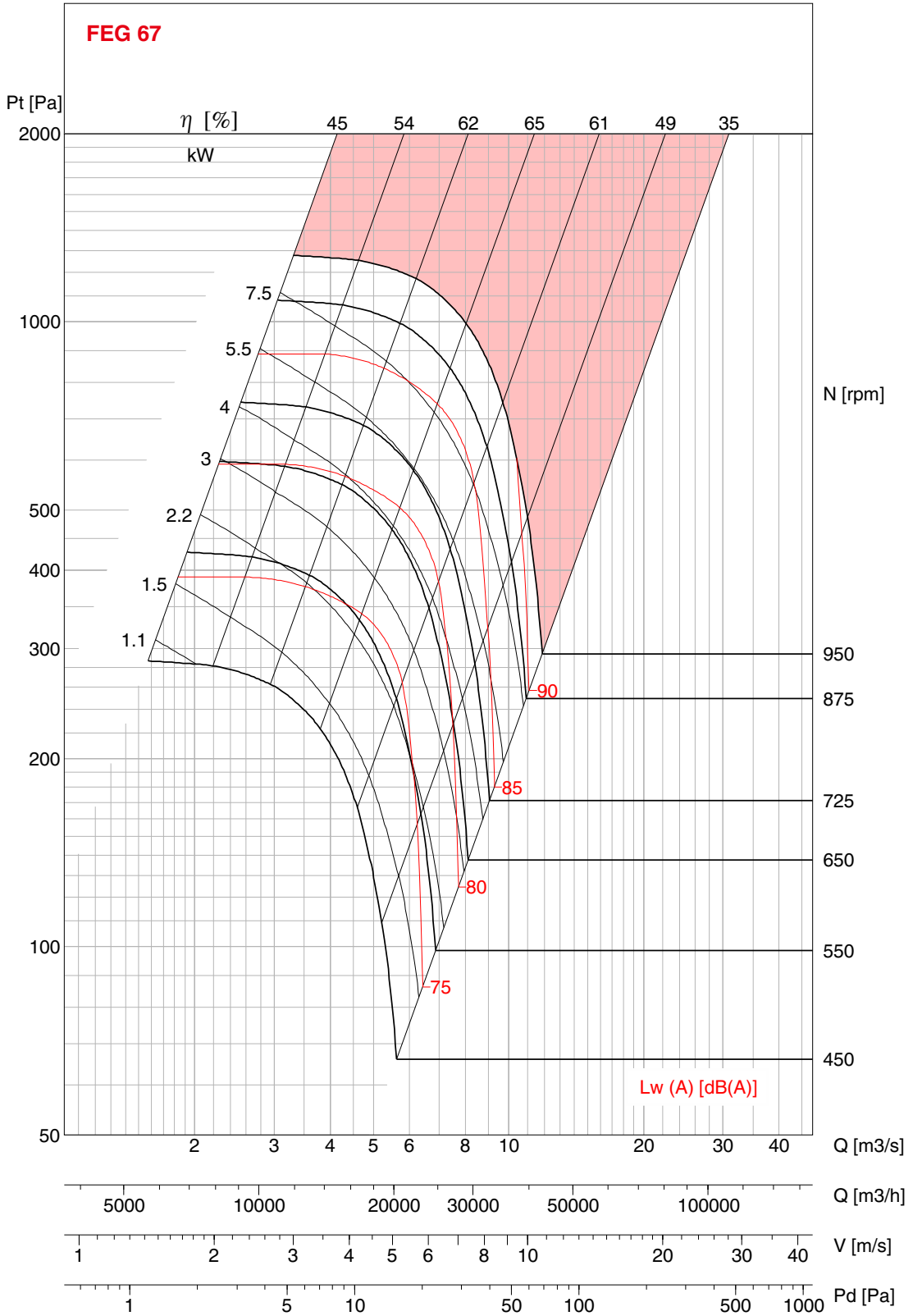

- Performance certified is for Installation type D - Ducted inlet, Ducted outlet. Performance ratings do not include the effects of appurtenances (belt cover). Power rating kW does not include transmission losses.  
 - The A-weighted sound ratings shown have been calculated per AMCA International Standard 301. Values shown are for inlet Lwi (A) sound power levels for installation type D - Ducted inlet, Ducted outlet. Ratings include the effects of duct end correction.



# CFC 315 (180)

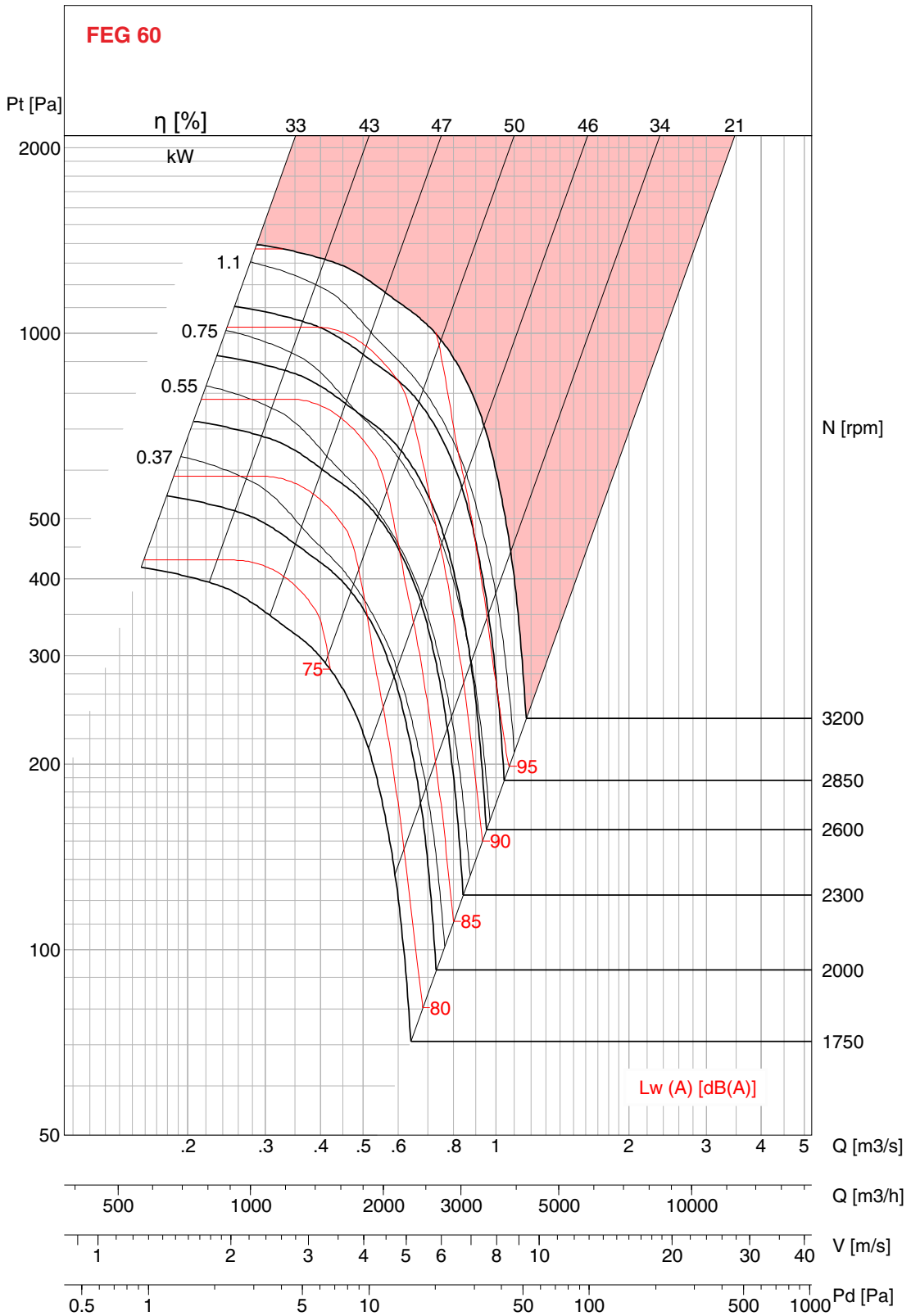

- Performance certified is for Installation type D - Ducted inlet, Ducted outlet. Performance ratings do not include the effects of appurtenances (belt cover). Power rating kW does not include transmission losses.  
- The A-weighted sound ratings shown have been calculated per AMCA International Standard 301. Values shown are for inlet Lw (A) sound power levels for installation type D - Ducted inlet, Ducted outlet. Ratings include the effects of duct end correction.



# CFC 355 (180)

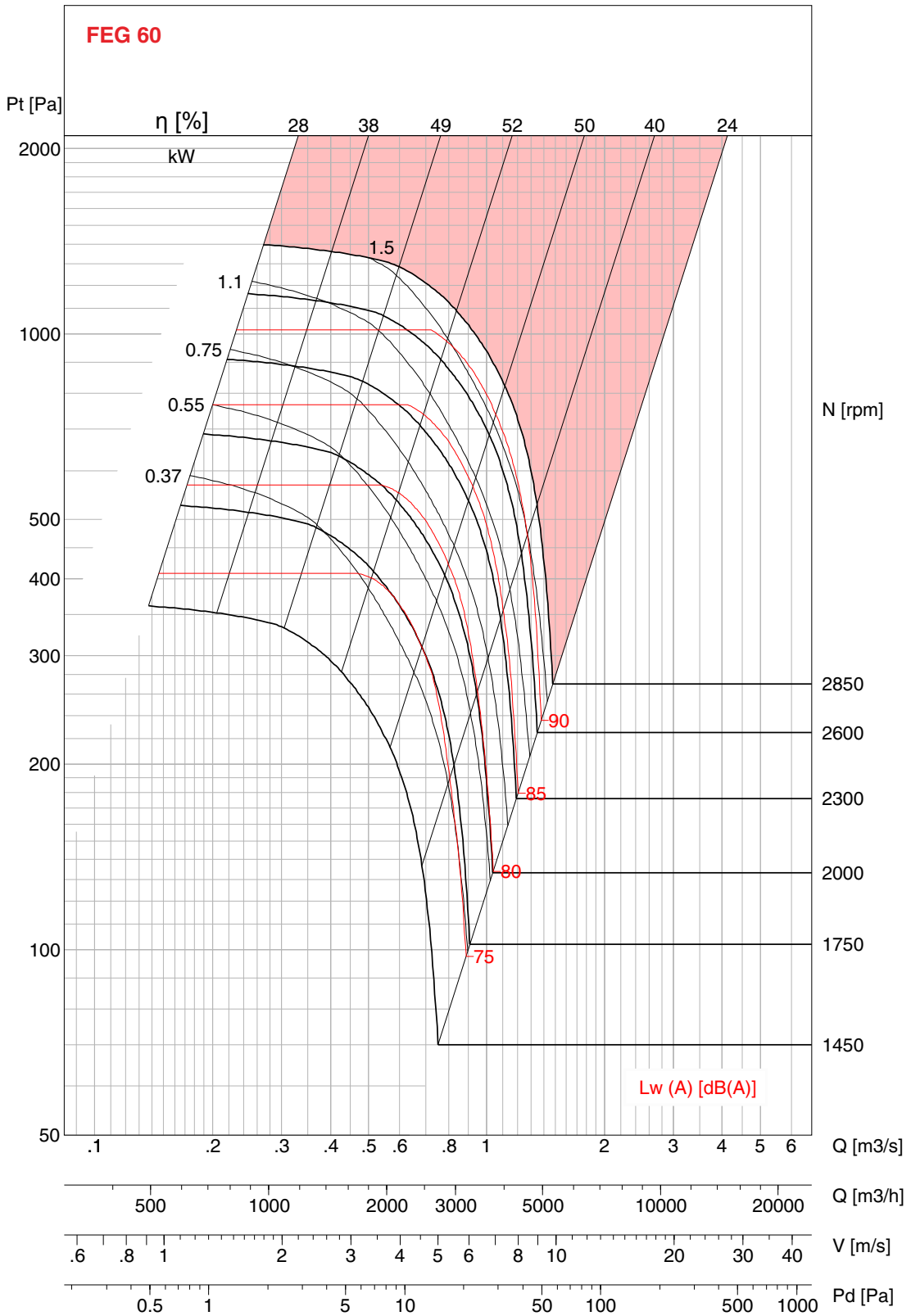

- Performance certified is for Installation type D - Ducted inlet, Ducted outlet. Performance ratings do not include the effects of appurtenances (belt cover). Power rating kW does not include transmission losses.  
- The A-weighted sound ratings shown have been calculated per AMCA International Standard 301. Values shown are for inlet Lw (A) sound power levels for installation type D - Ducted inlet, Ducted outlet. Ratings include the effects of duct end correction.



# CFC 400 (180)

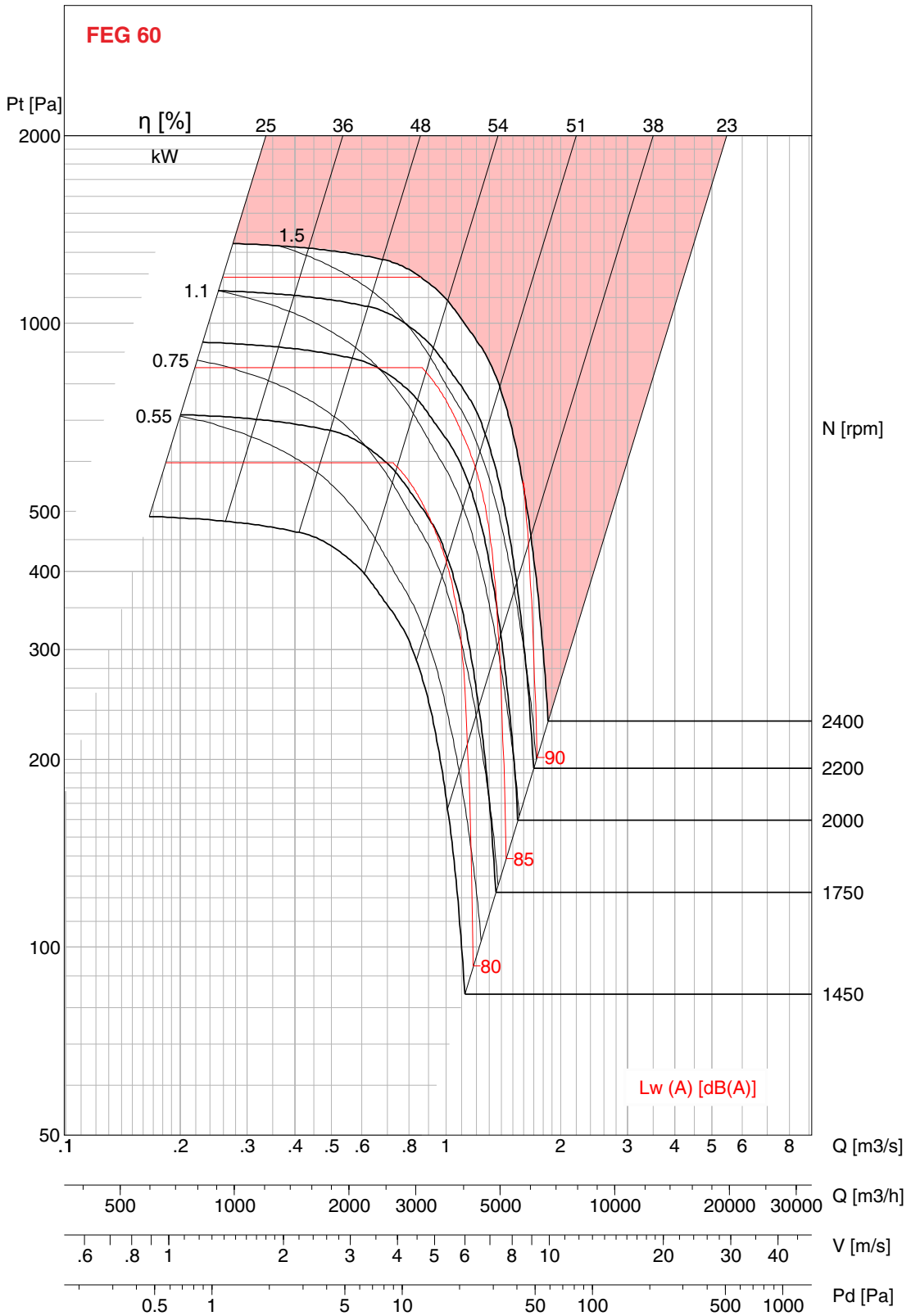

- Performance certified is for Installation type D - Ducted inlet, Ducted outlet. Performance ratings do not include the effects of appurtenances (belt cover). Power rating kW does not include transmission losses.  
 - The A-weighted sound ratings shown have been calculated per AMCA International Standard 301. Values shown are for inlet Lw (A) sound power levels for installation type D - Ducted inlet, Ducted outlet. Ratings include the effects of duct end correction.



# CFC 450 (180)

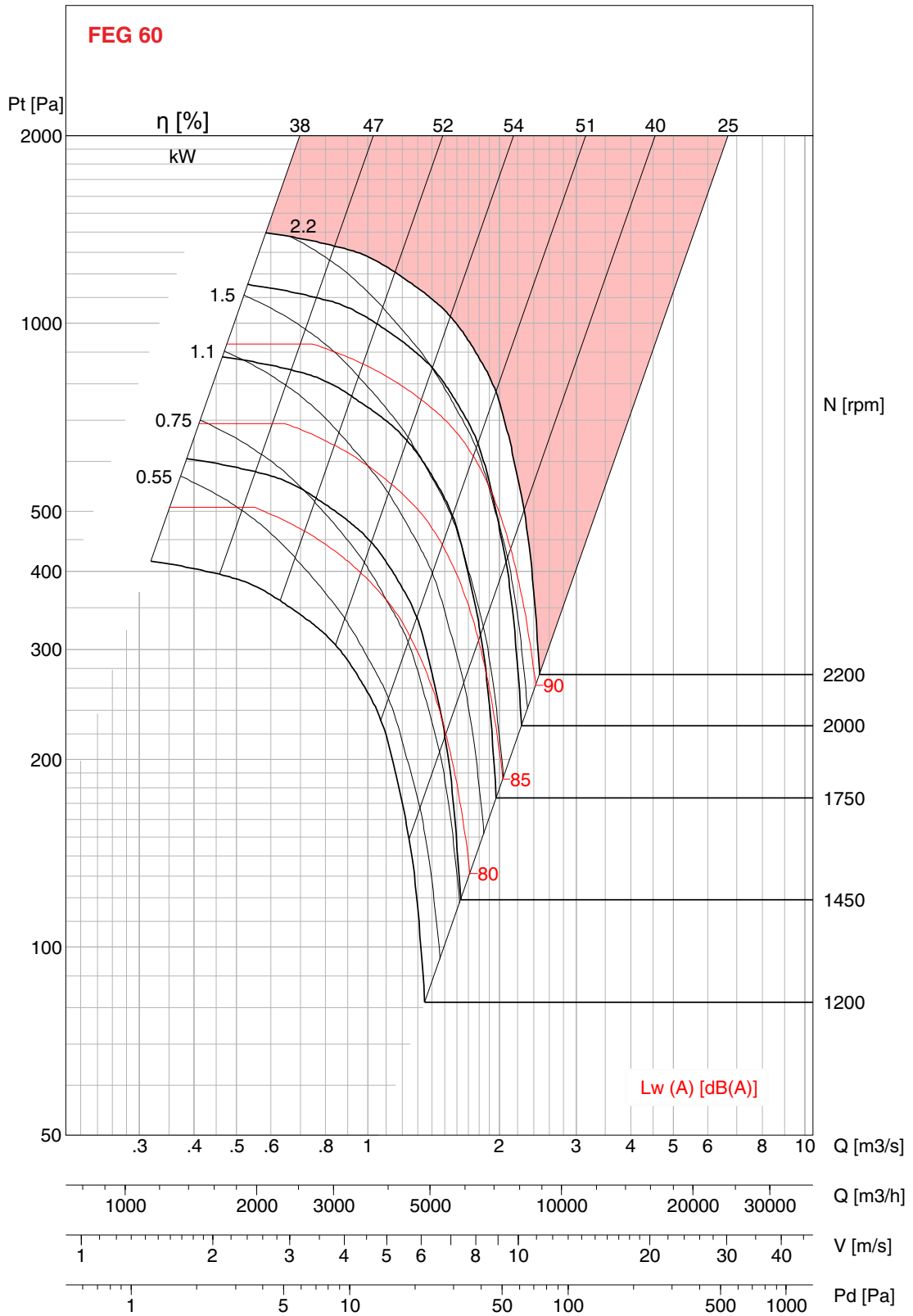

- Performance certified is for Installation type D - Ducted inlet, Ducted outlet. Performance ratings do not include the effects of appurtenances (belt cover). Power rating kW does not include transmission losses.  
- The A-weighted sound ratings shown have been calculated per AMCA International Standard 301. Values shown are for inlet Lw (A) sound power levels for installation type D - Ducted inlet, Ducted outlet. Ratings include the effects of duct end correction.



# CFC 500 (180)

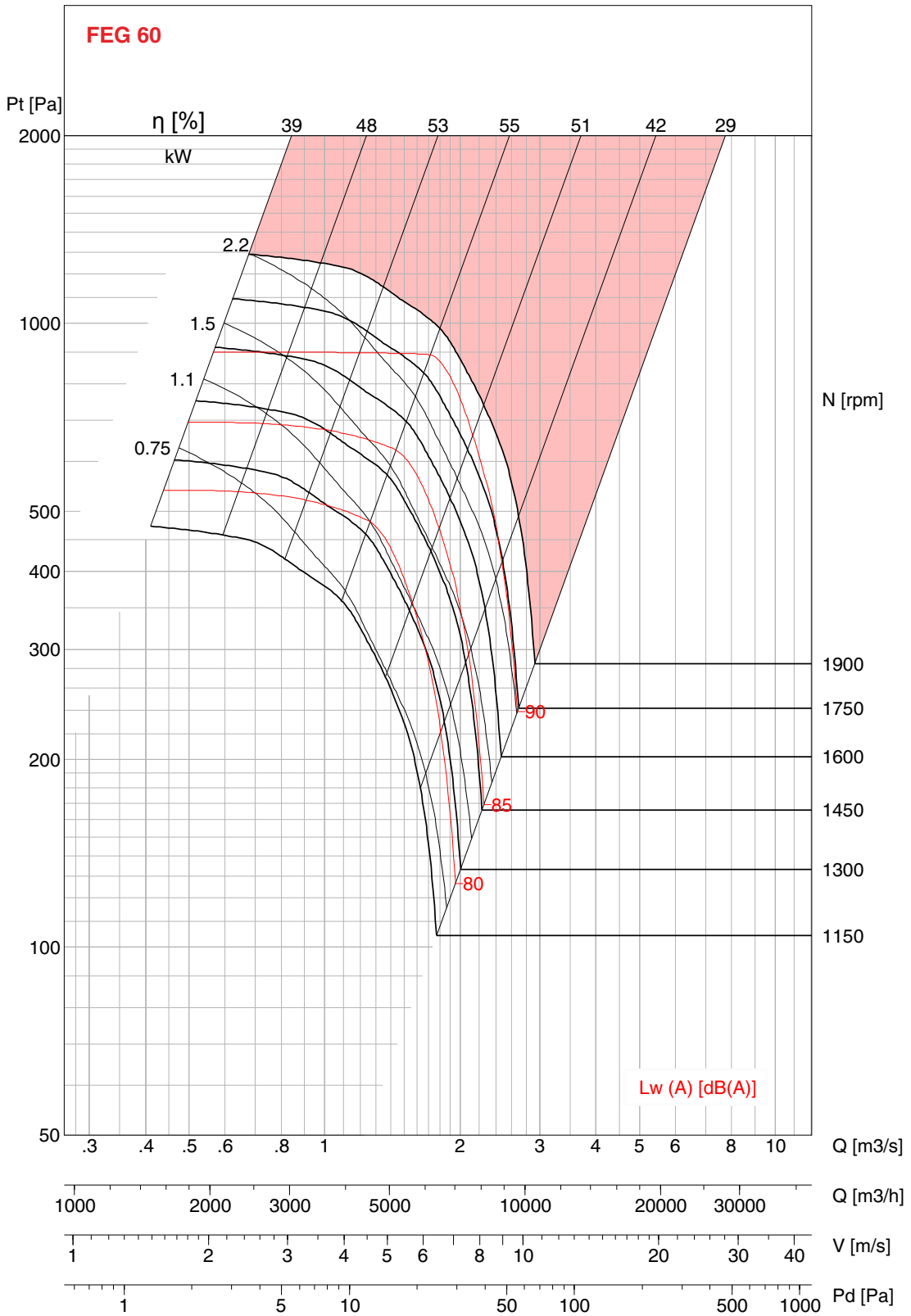

- Performance certified is for Installation type D - Ducted inlet, Ducted outlet. Performance ratings do not include the effects of appurtenances (belt cover). Power rating kW does not include transmission losses.  
 - The A-weighted sound ratings shown have been calculated per AMCA International Standard 301. Values shown are for inlet Lw (A) sound power levels for installation type D - Ducted inlet, Ducted outlet. Ratings include the effects of duct end correction.



# CFC 560 (180)

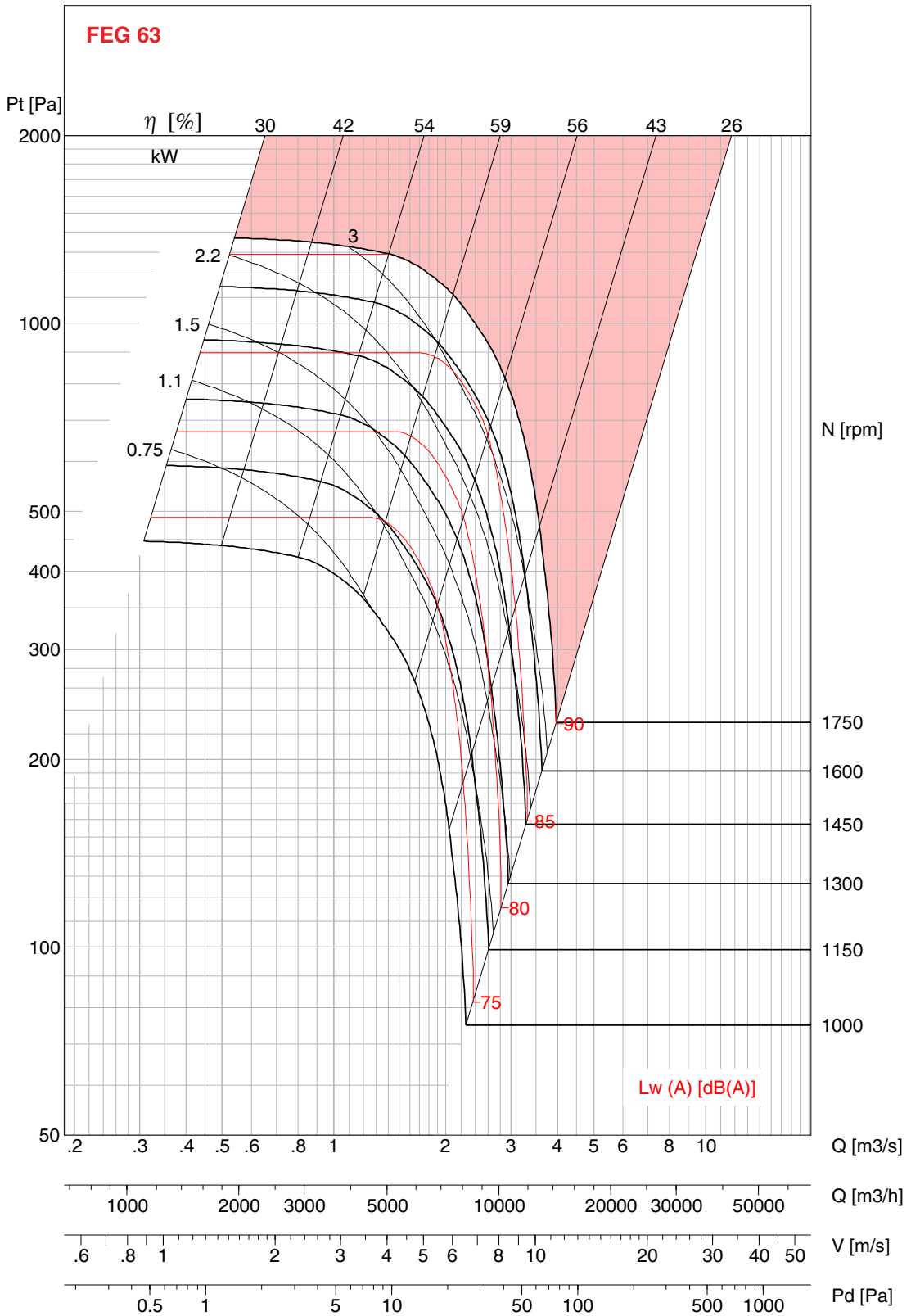

- Performance certified is for Installation type D - Ducted inlet, Ducted outlet. Performance ratings do not include the effects of appurtenances (belt cover). Power rating kW does not include transmission losses.

- The A-weighted sound ratings shown have been calculated per AMCA International Standard 301. Values shown are for inlet Lw (A) sound power levels for installation type D - Ducted inlet, Ducted outlet. Ratings include the effects of duct end correction.



# CFC 630 (180)

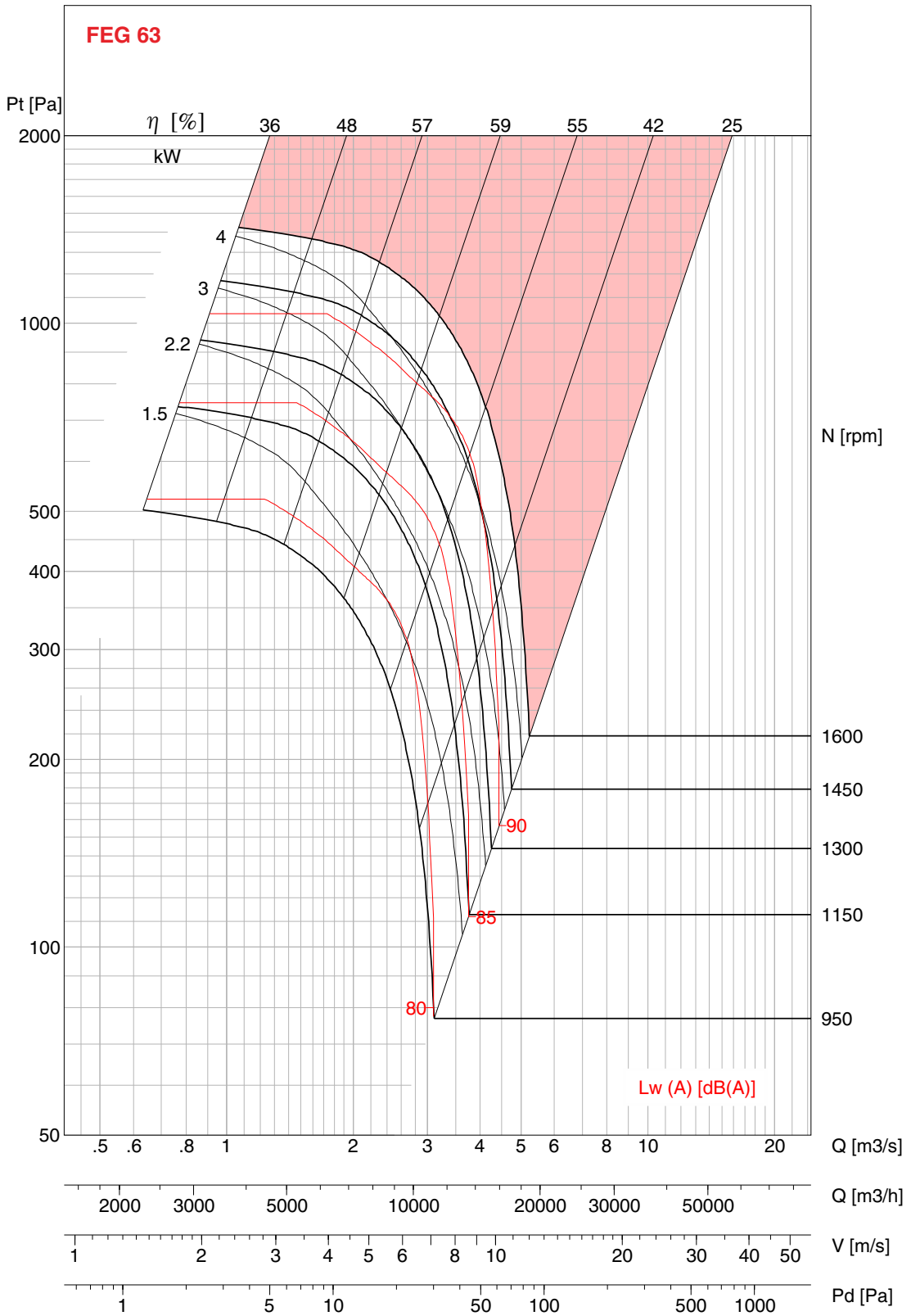

- Performance certified is for Installation type D - Ducted inlet, Ducted outlet. Performance ratings do not include the effects of appurtenances (belt cover). Power rating kW does not include transmission losses.  
- The A-weighted sound ratings shown have been calculated per AMCA International Standard 301. Values shown are for inlet Lw (A) sound power levels for installation type D - Ducted inlet, Ducted outlet. Ratings include the effects of duct end correction.





# CFC 710 (180)

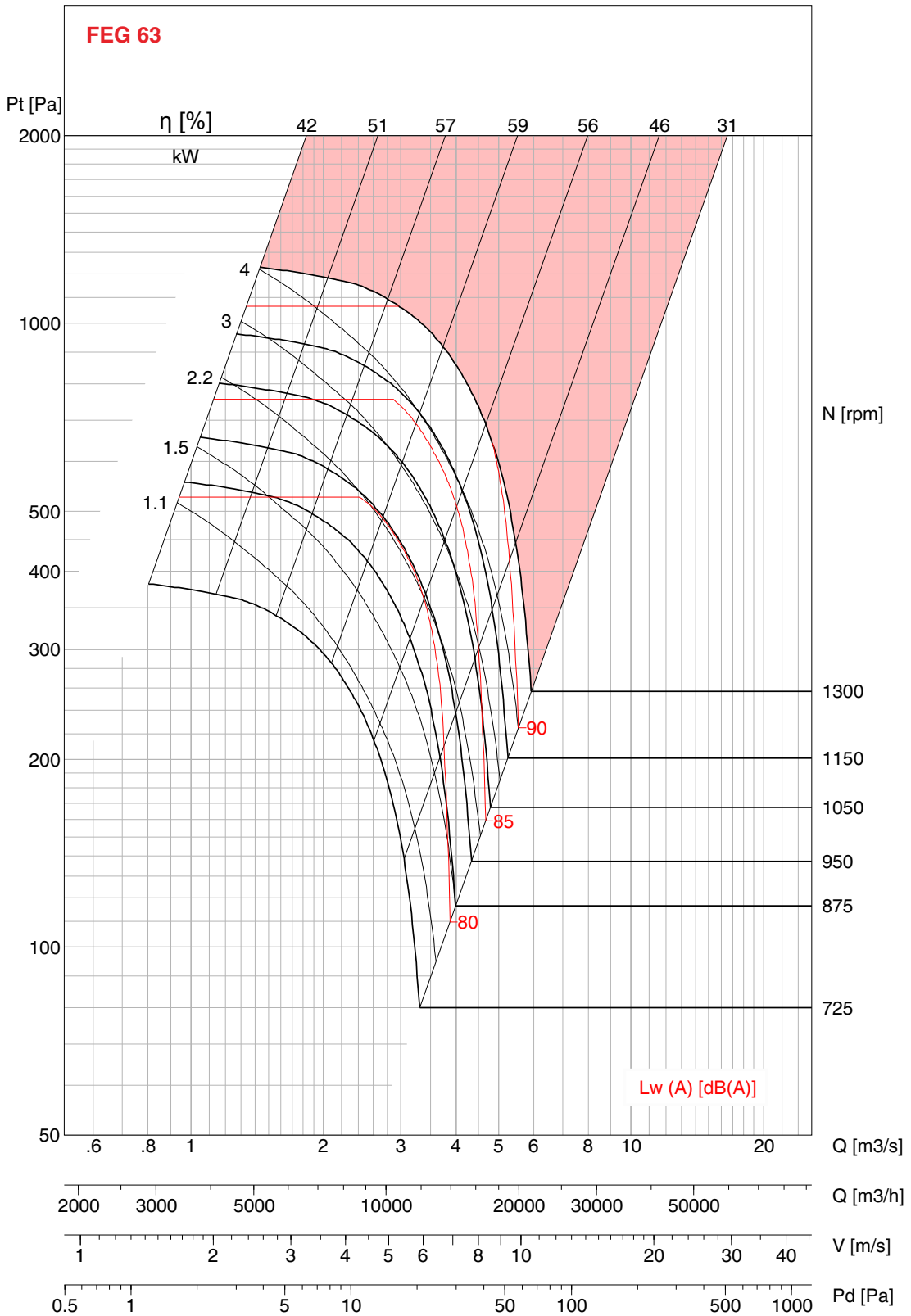

- Performance certified is for Installation type D - Ducted inlet, Ducted outlet. Performance ratings do not include the effects of appurtenances (belt cover). Power rating kW does not include transmission losses.  
- The A-weighted sound ratings shown have been calculated per AMCA International Standard 301. Values shown are for inlet Lwi (A) sound power levels for installation type D - Ducted inlet, Ducted outlet. Ratings include the effects of duct end correction.



# CFC 800 (180)

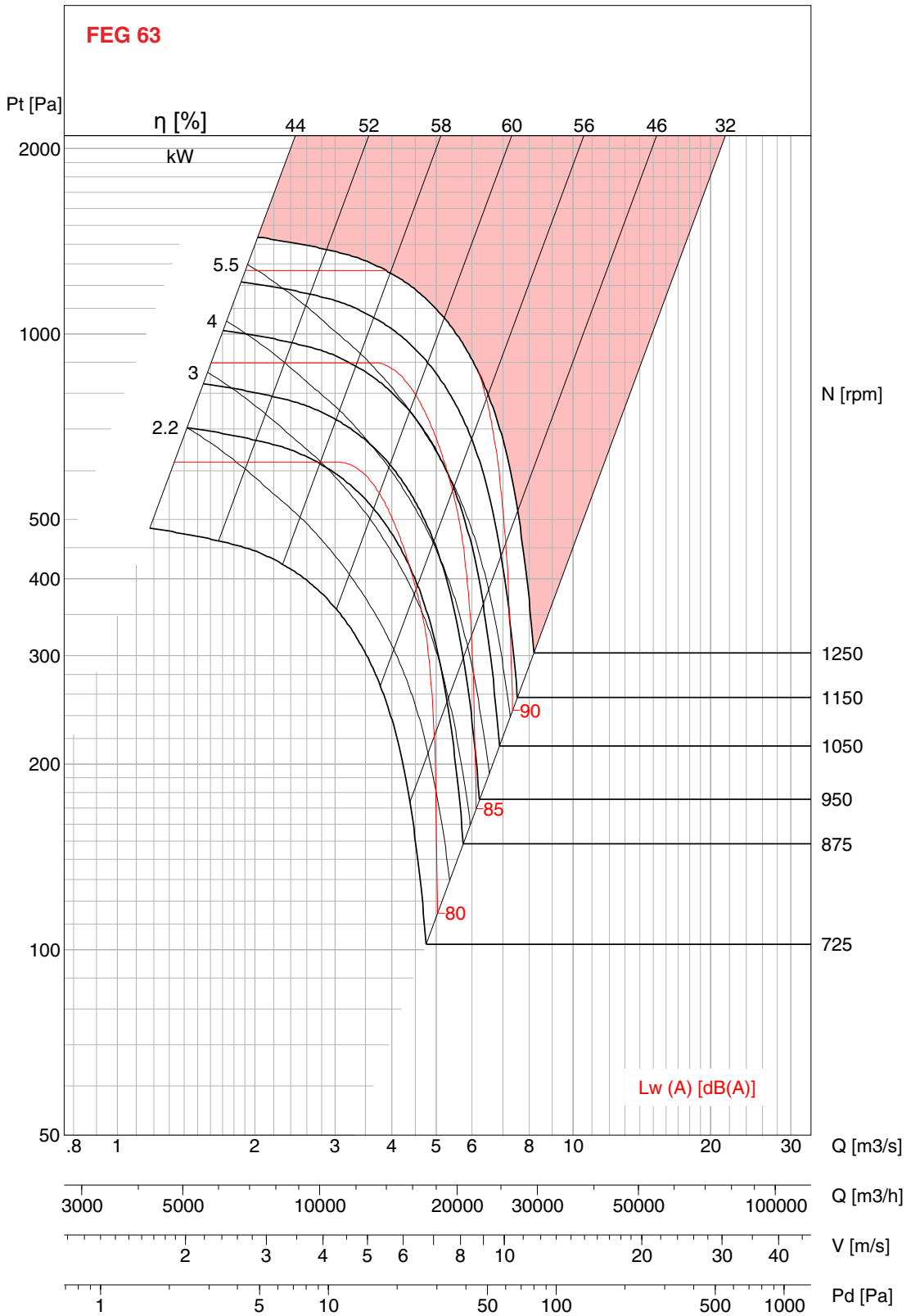

- Performance certified is for Installation type D - Ducted inlet, Ducted outlet. Performance ratings do not include the effects of appurtenances (belt cover). Power rating kW does not include transmission losses.  
- The A-weighted sound ratings shown have been calculated per AMCA International Standard 301. Values shown are for inlet Lwi (A) sound power levels for installation type D - Ducted inlet, Ducted outlet. Ratings include the effects of duct end correction.



# CFC 900 (180)

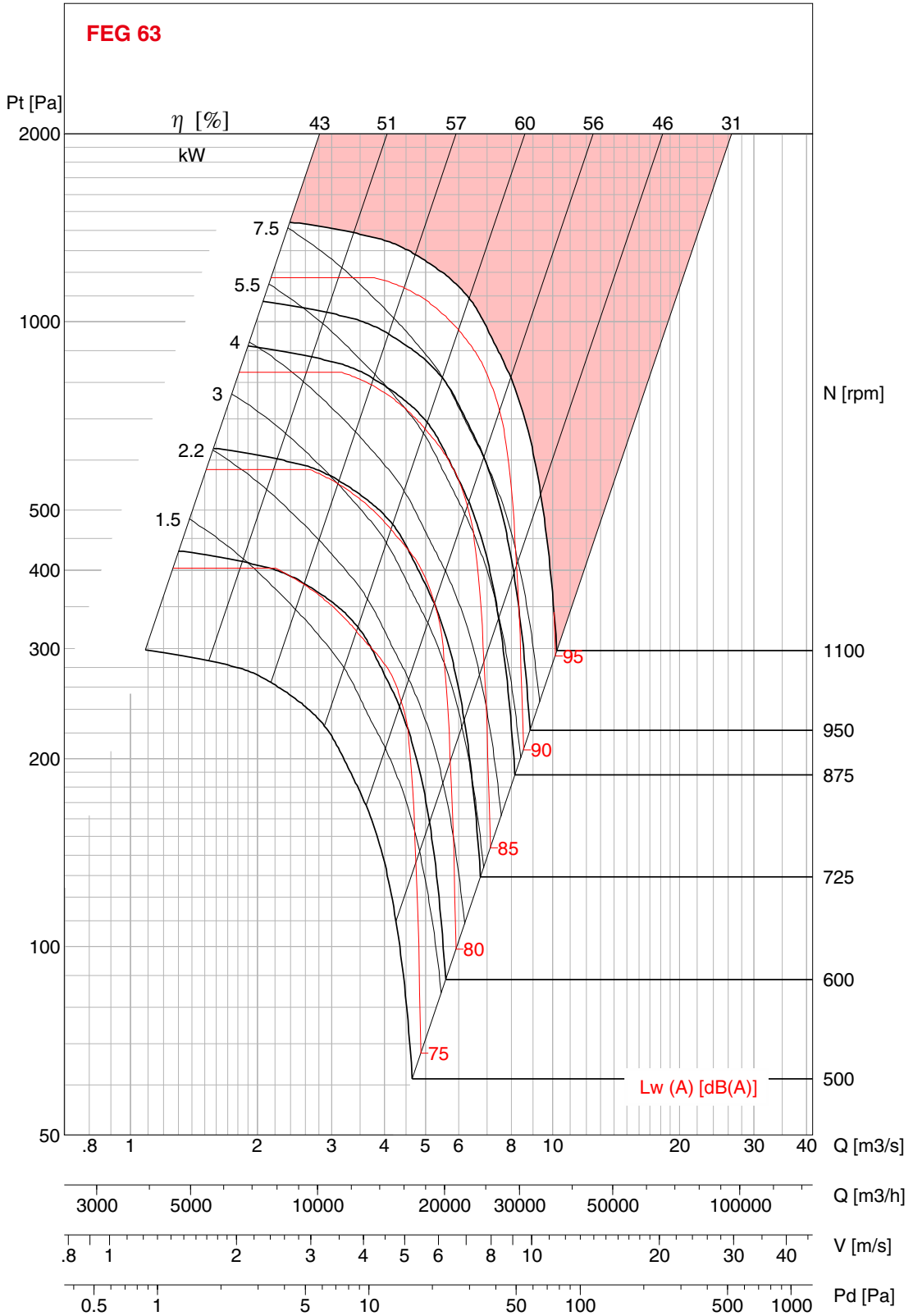

- Performance certified for Installation type D - Ducted inlet, Ducted outlet. Performance ratings do not include the effects of appurtenances (belt cover). Power rating kW does not include transmission losses.  
 - The A-weighted sound ratings shown have been calculated per AMCA International Standard 301. Values shown are for inlet Lwi (A) sound power levels for installation type D - Ducted inlet, Ducted outlet. Ratings include the effects of duct end correction.



# CFC 1000 (180)

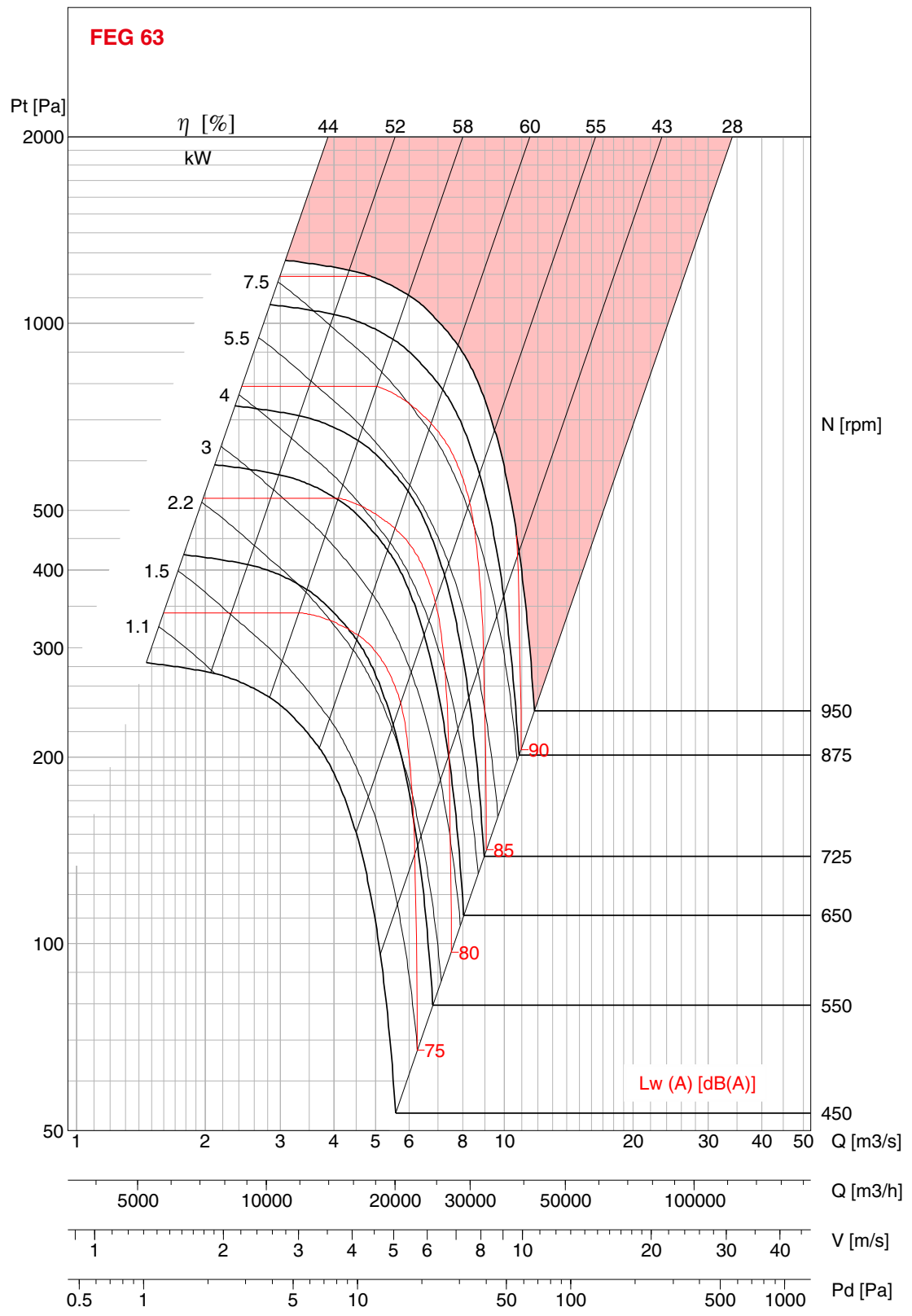

- Performance certified is for Installation type D - Ducted inlet, Ducted outlet. Performance ratings do not include the effects of appurtenances (belt cover). Power rating kW does not include transmission losses.  
 - The A-weighted sound ratings shown have been calculated per AMCA International Standard 301. Values shown are for inlet Lwi (A) sound power levels for installation type D - Ducted inlet, Ducted outlet. Ratings include the effects of duct end correction.

# Fan Energy Index

## Example of FEI Selection

Air Volume Q = 2.14 m<sup>3</sup>/s  
 Fan Speed N = 1450 rpm  
 FEI = 1.09

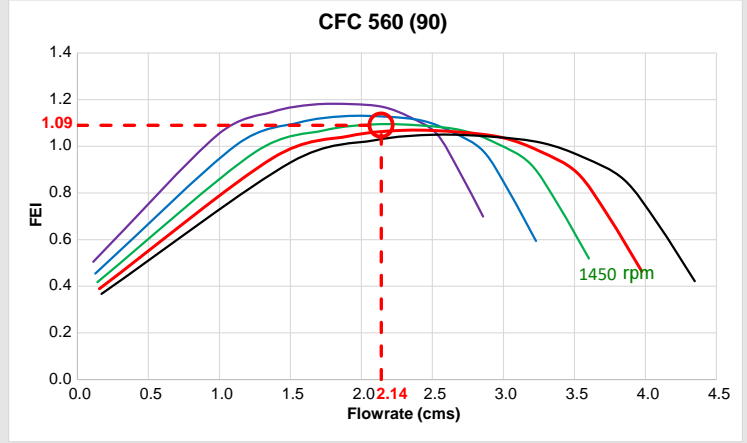

## Direct Drive models

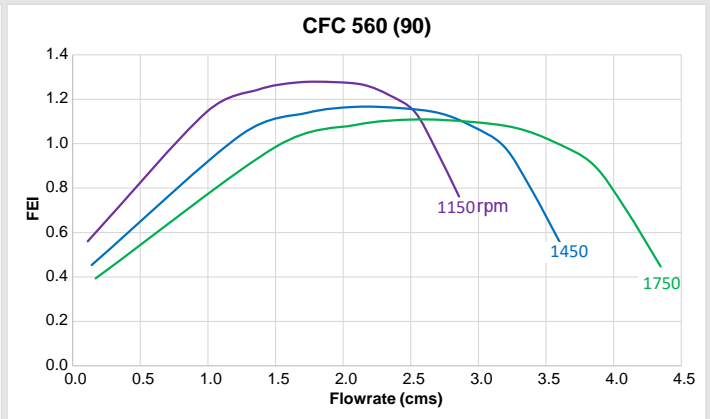
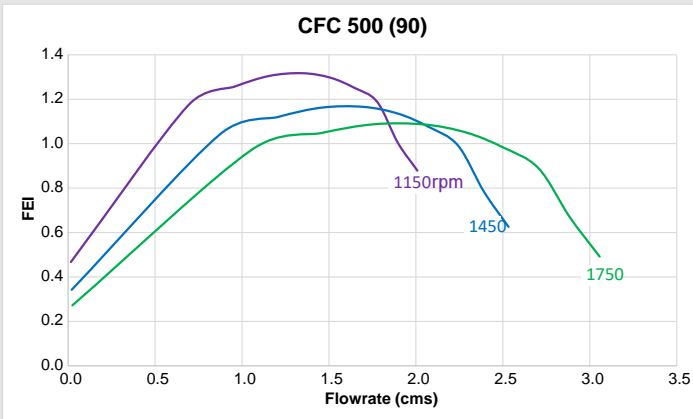
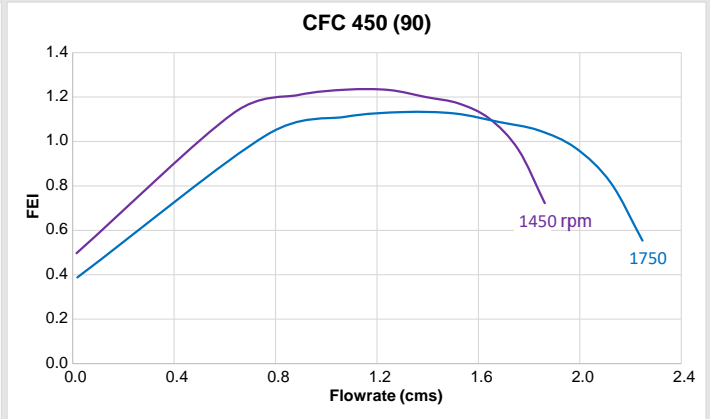
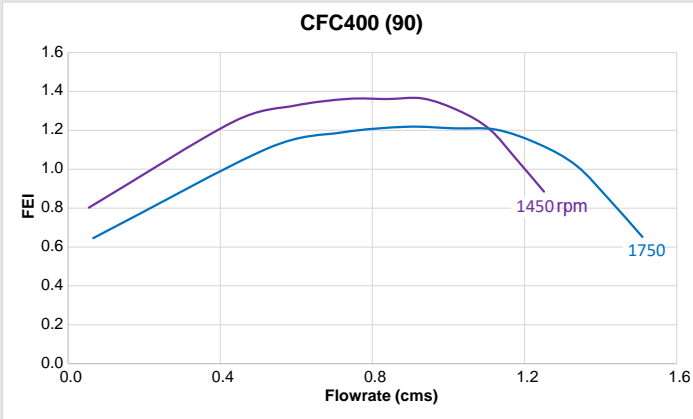
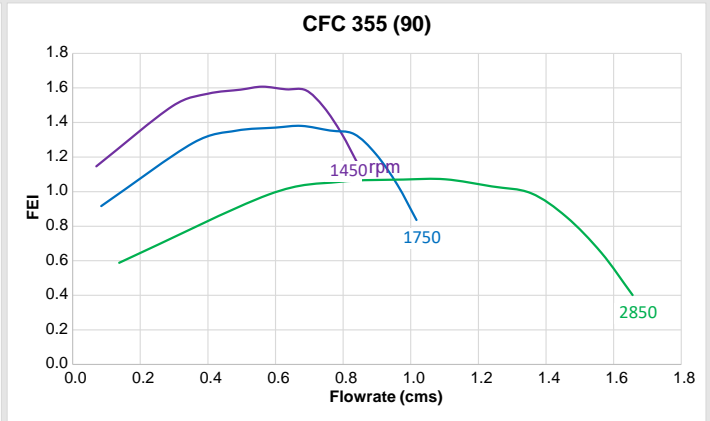
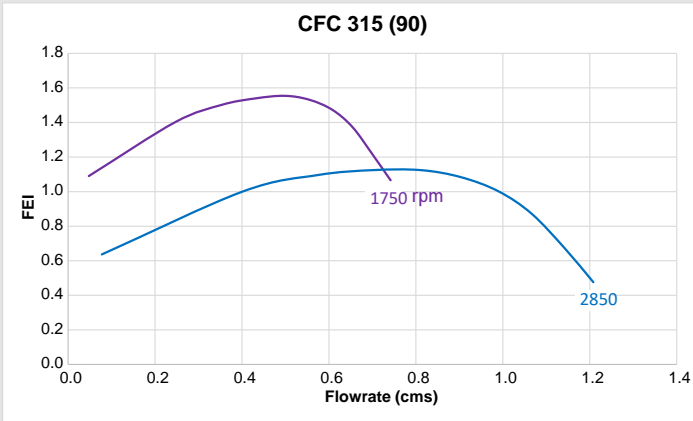

Performance certified is for installation type D - Ducted inlet, Ducted outlet. Power rating (kW) does not include transmission losses. Performance ratings do not include the effects of appurtenances (accessories). FEI<sub>T</sub> values are calculated in accordance with ANSI/AMCA Standard 208 and are based on default motor efficiencies (Direct Driven type). FEI<sub>T</sub> values for fans with specific motors will vary slightly from those shown. Fan speed shown in RPM.

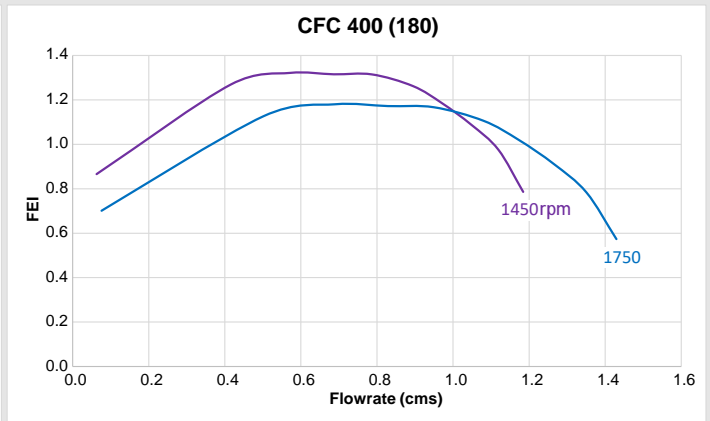
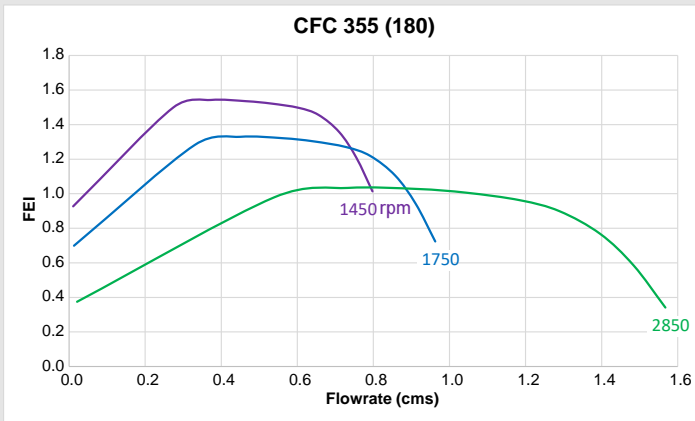
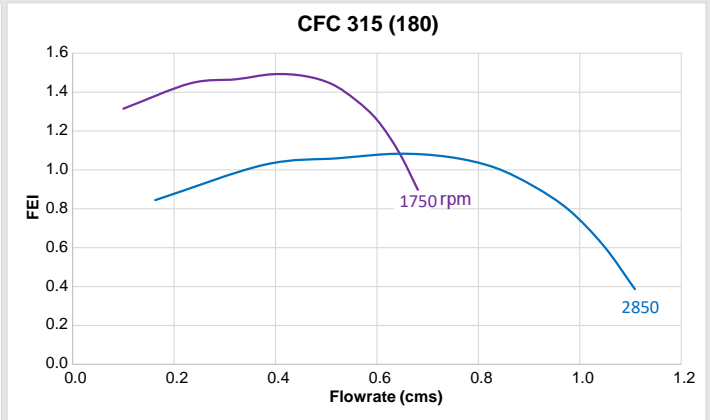
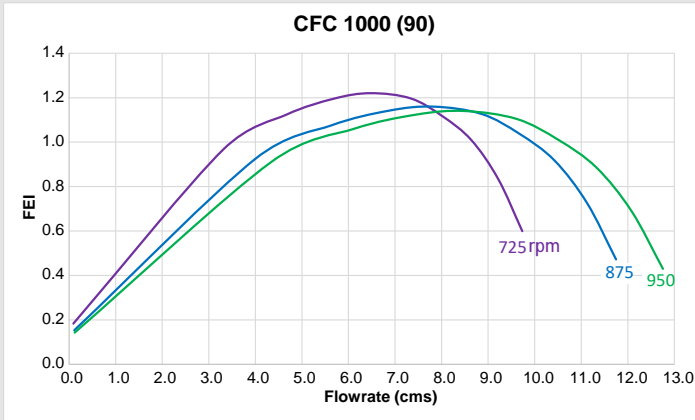
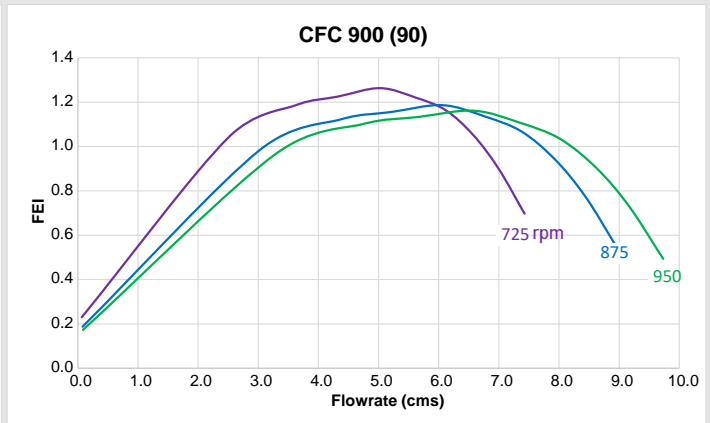
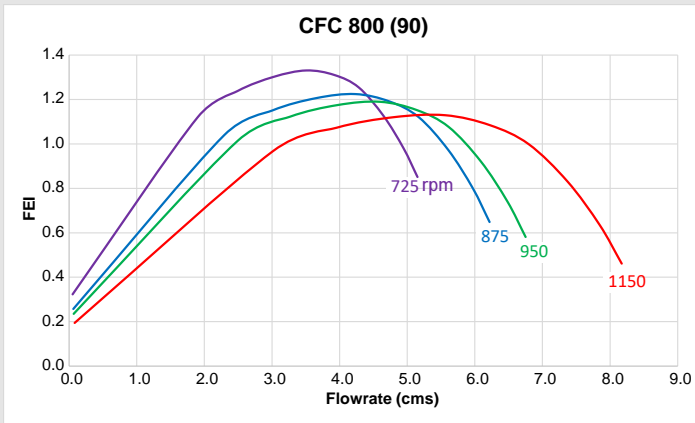
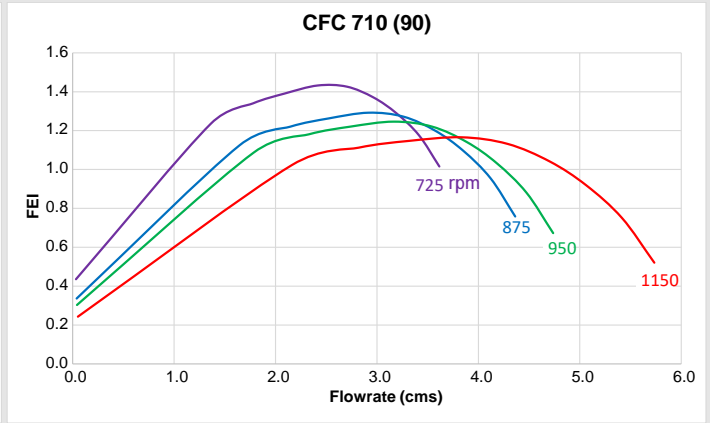
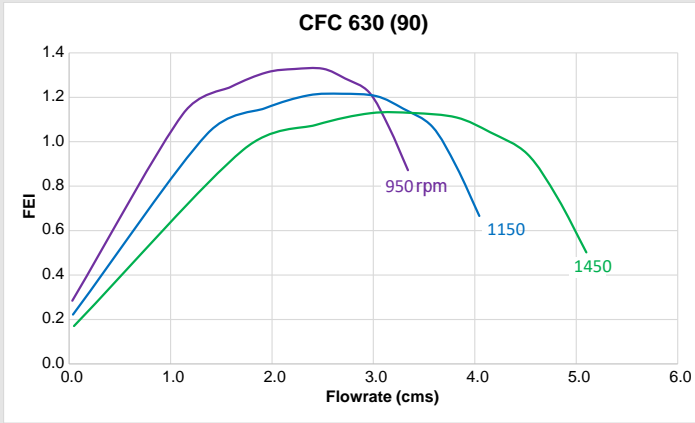

Performance certified is for installation type D - Ducted inlet, Ducted outlet. Power rating (kW) does not include transmission losses. Performance ratings do not include the effects of appurtenances (accessories). FEI<sub>T</sub> values are calculated in accordance with ANSI/AMCA Standard 208 and are based on default motor efficiencies (Direct Driven type). FEI<sub>T</sub> values for fans with specific motors will vary slightly from those shown. Fan speed shown in RPM.

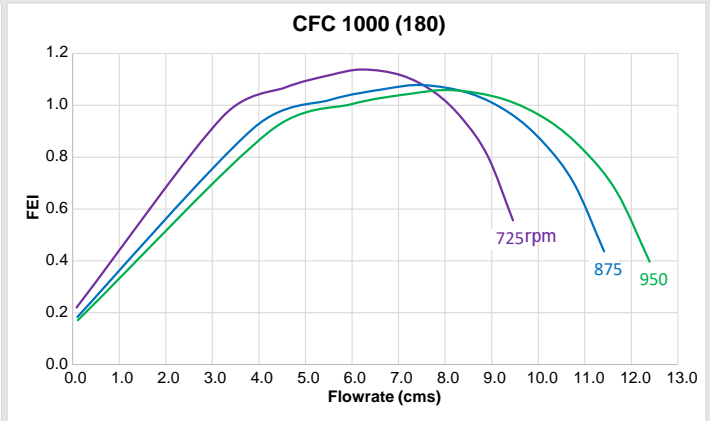
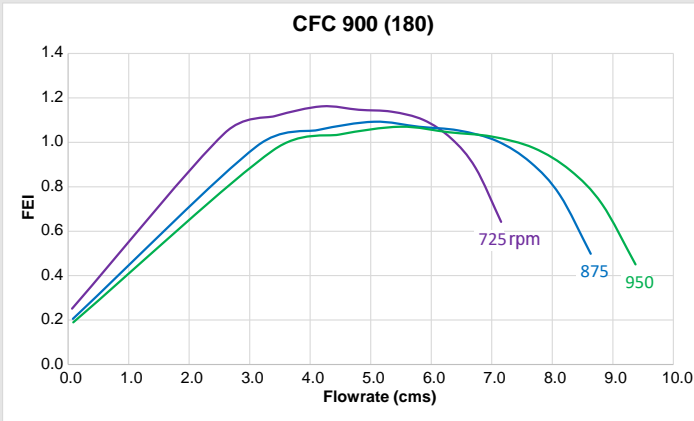
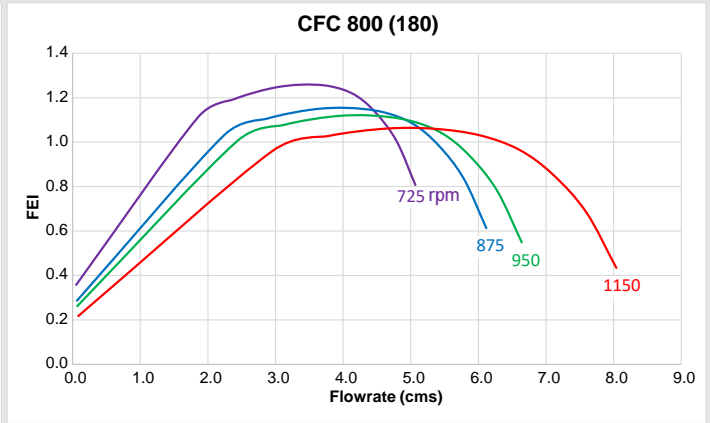
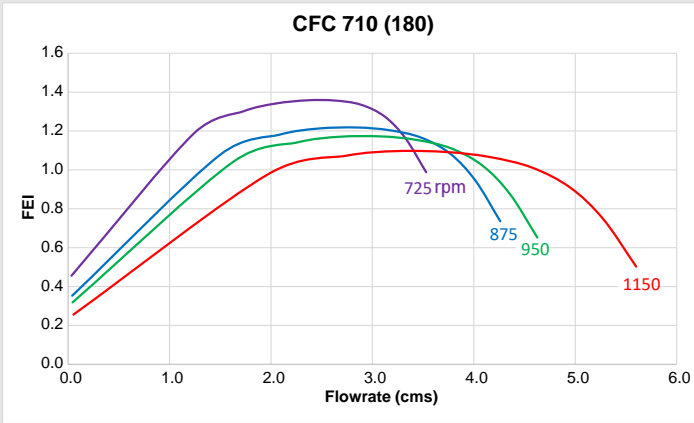
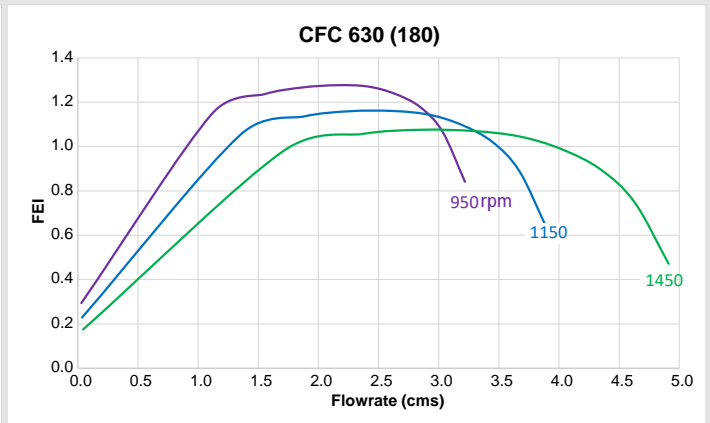
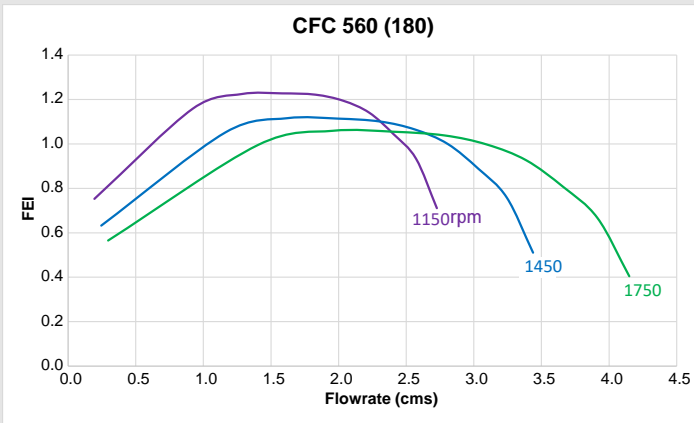
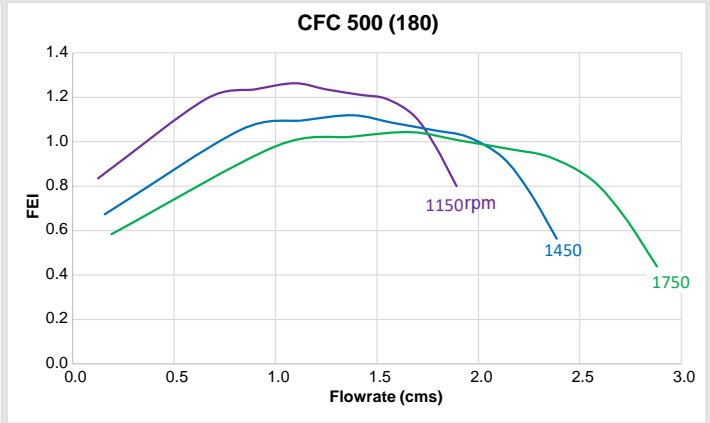
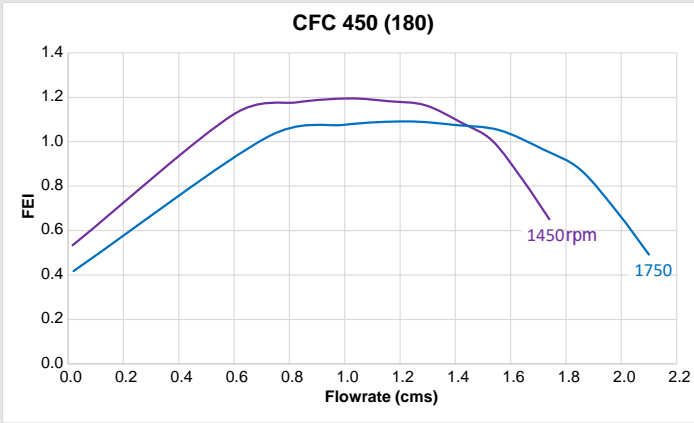

Performance certified is for installation type D - Ducted inlet, Ducted outlet. Power rating (kW) does not include transmission losses. Performance ratings do not include the effects of appurtenances (accessories). FEI<sub>r</sub> values are calculated in accordance with ANSI/AMCA Standard 208 and are based on default motor efficiencies (Direct Driven type). FEI<sub>r</sub> values for fans with specific motors will vary slightly from those shown. Fan speed shown in RPM.

**Belt Drive models**

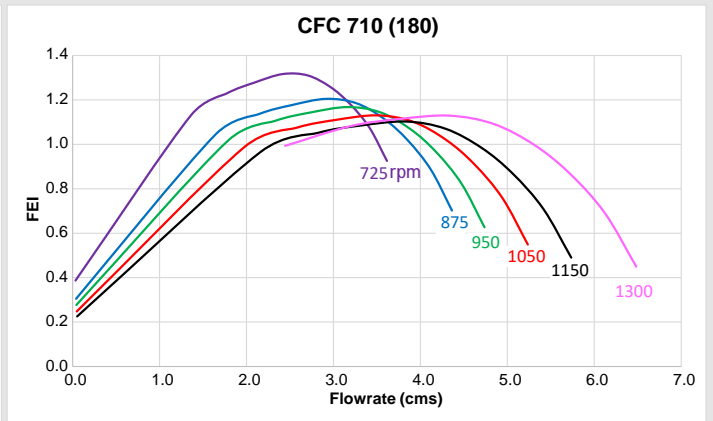
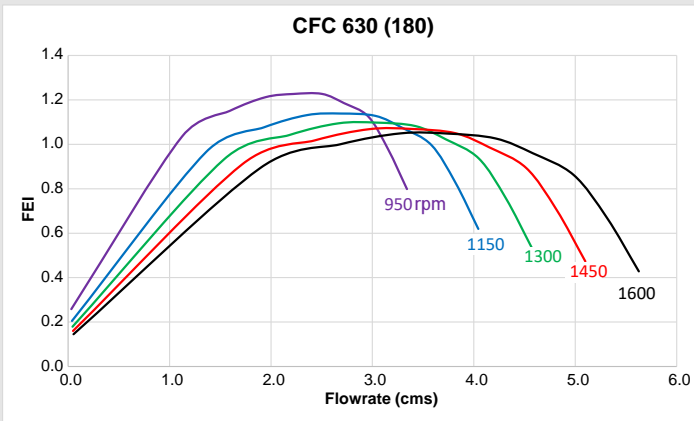
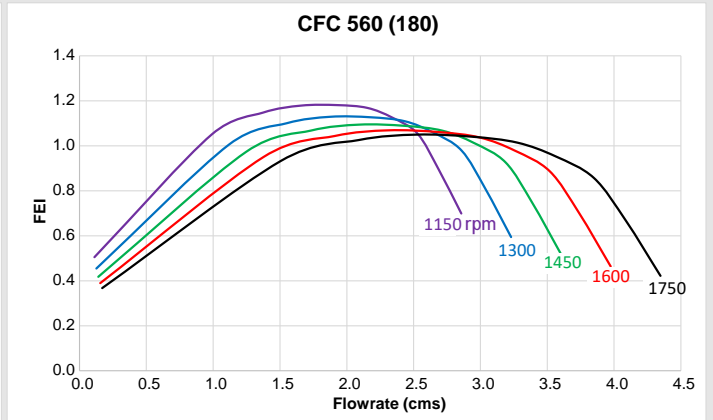
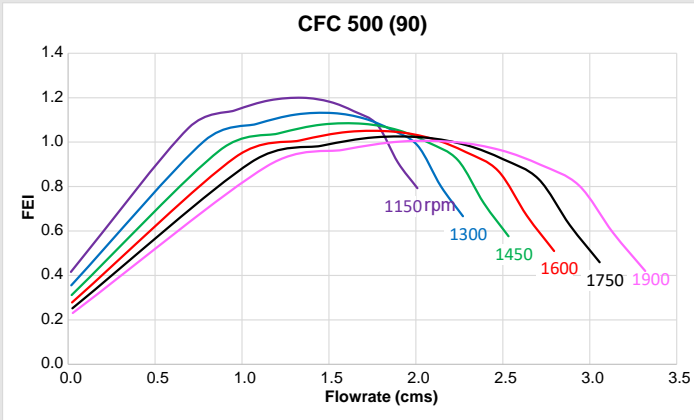
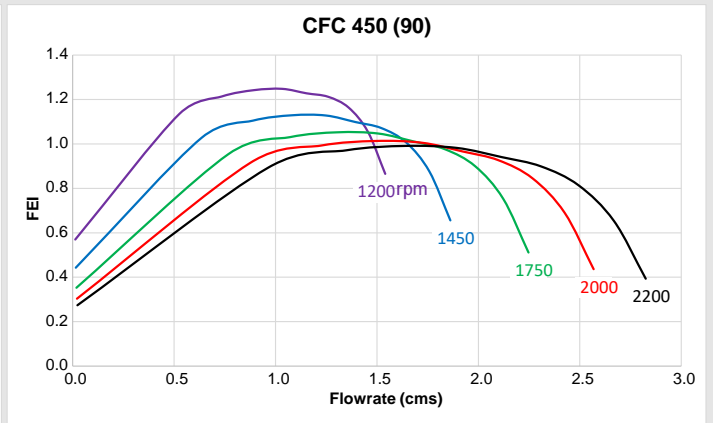
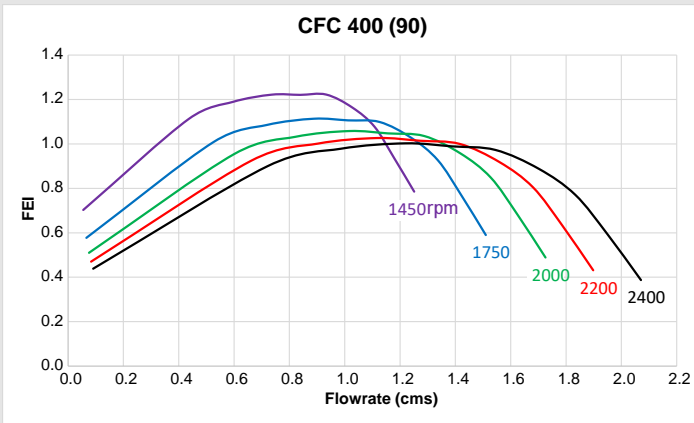
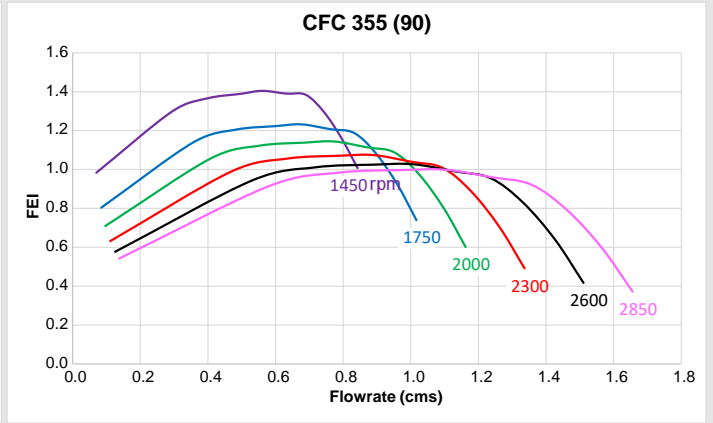
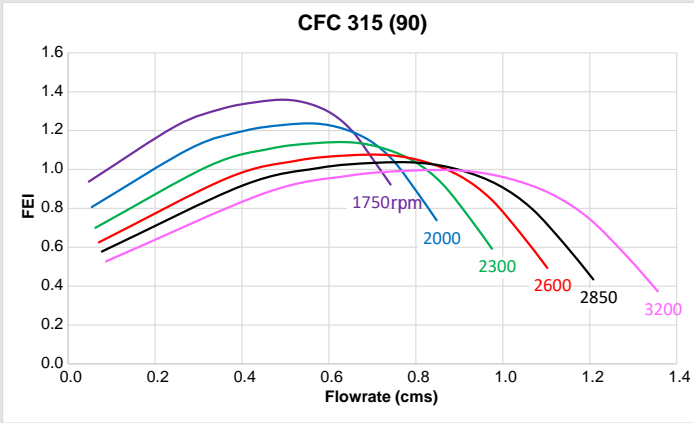

Performance certified is for installation type D - Ducted inlet, Ducted outlet. Power rating (kW) does not include transmission losses. Performance ratings do not include the effects of appurtenances (belt cover). FEI<sub>T</sub> values are calculated in accordance with ANSI/AMCA Standard 208 and are based on default motor efficiencies (Belt Driven type). FEI<sub>T</sub> values for fans with specific motors will vary slightly from those shown. Fan speed shown in RPM.



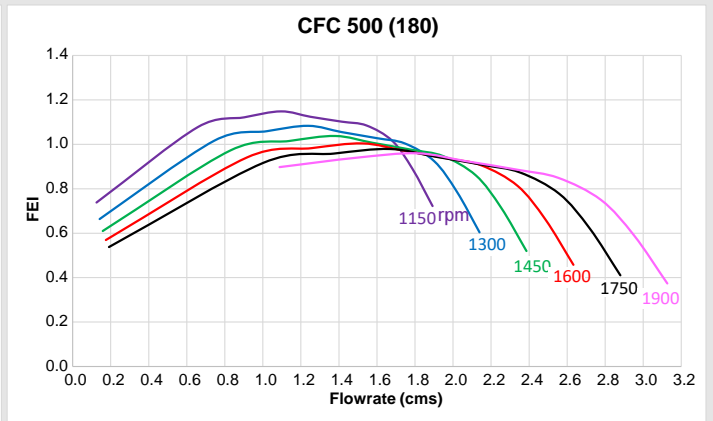
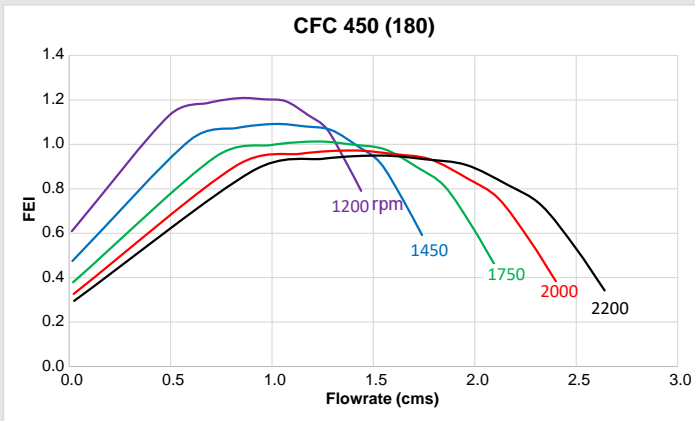
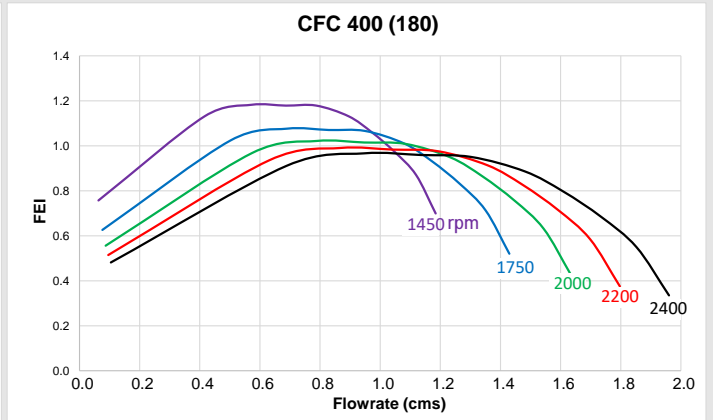
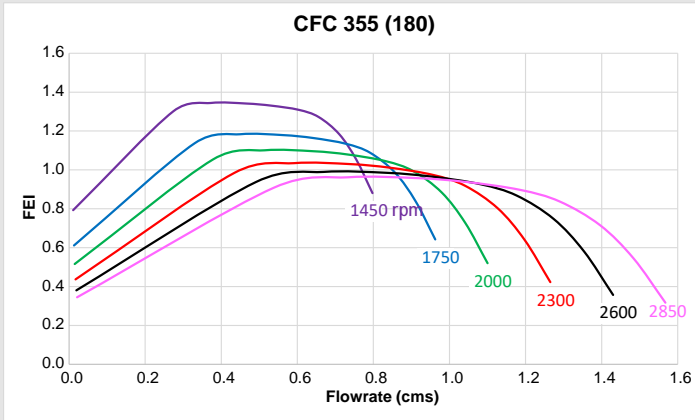
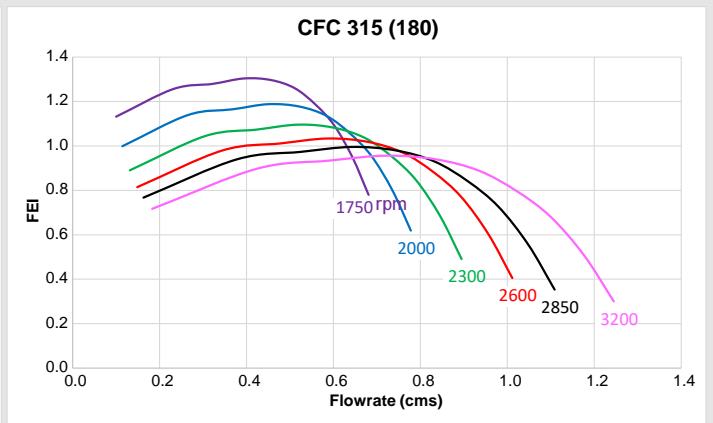
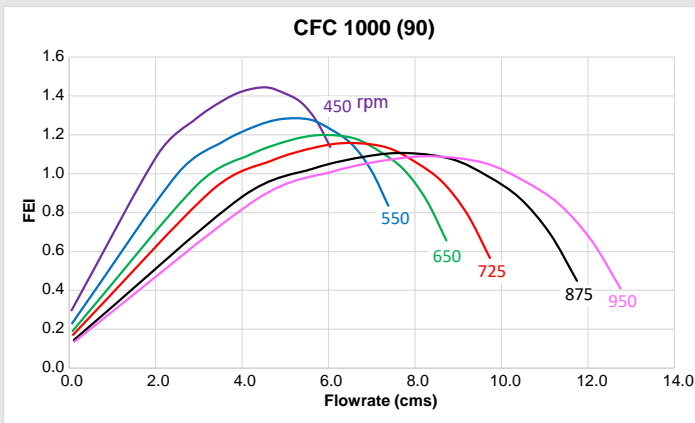
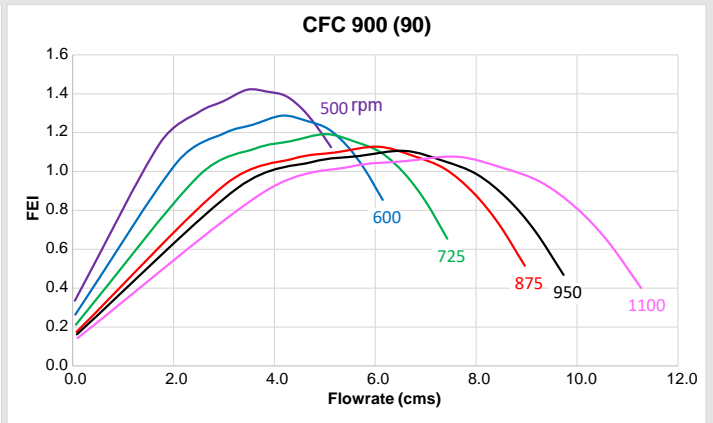
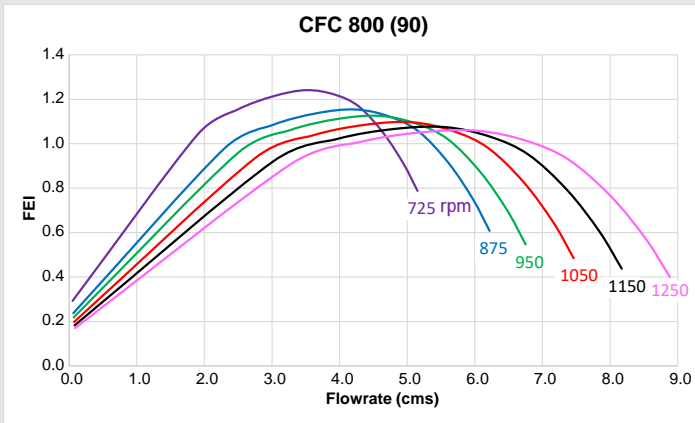

Performance certified is for installation type D - Ducted inlet, Ducted outlet. Power rating (kW) does not include transmission losses. Performance ratings do not include the effects of appurtenances (belt cover). FEI<sub>T</sub> values are calculated in accordance with ANSI/AMCA Standard 208 and are based on default motor efficiencies (Belt Driven type). FEI<sub>T</sub> values for fans with specific motors will vary slightly from those shown. Fan speed shown in RPM.

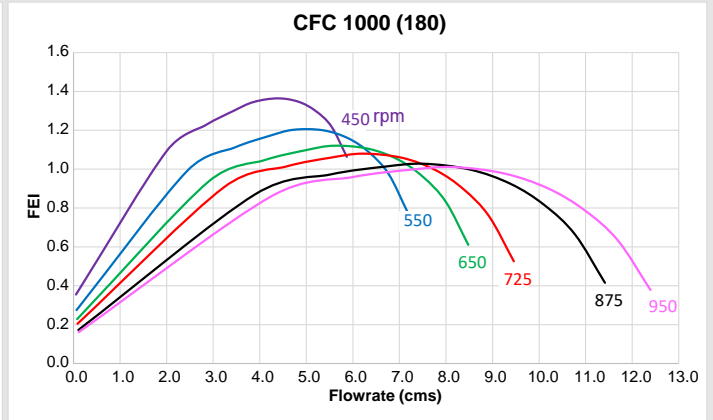
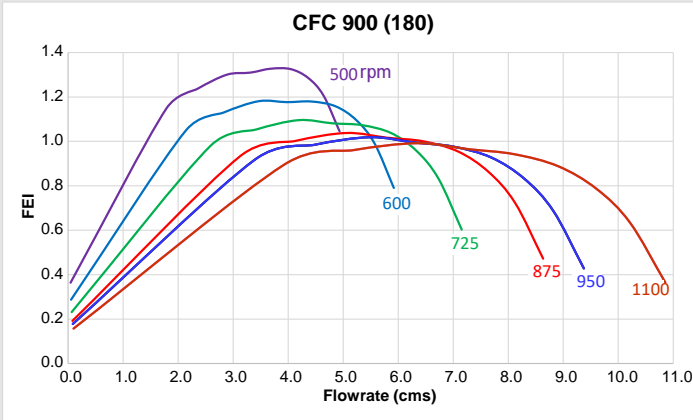
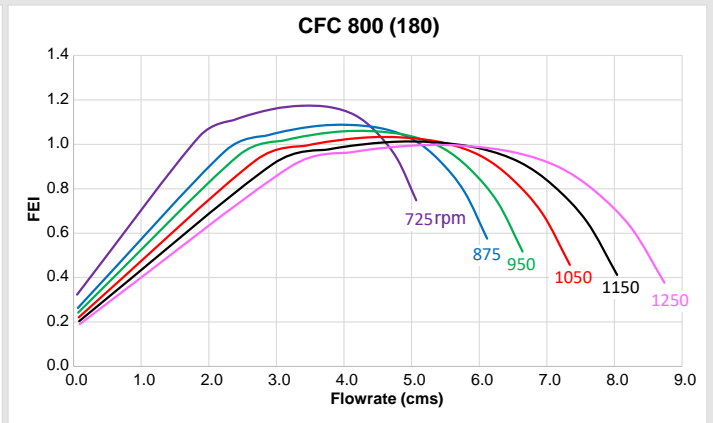
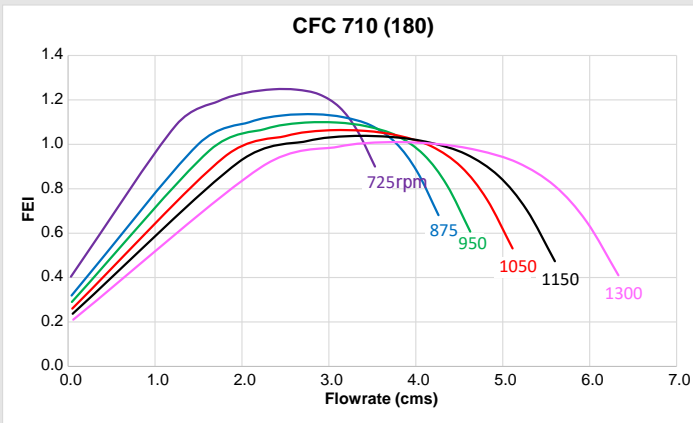
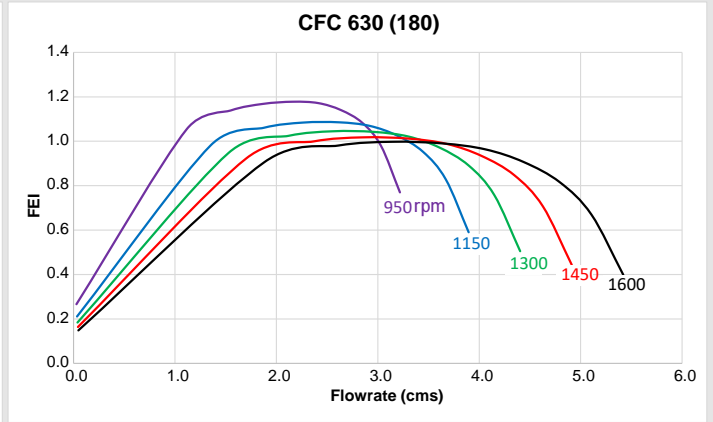
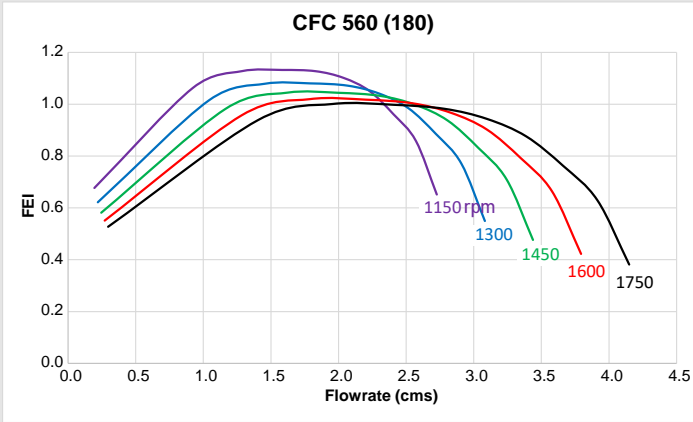

Performance certified is for installation type D - Ducted inlet, Ducted outlet. Power rating (kW) does not include transmission losses. Performance ratings do not include the effects of appurtenances (belt cover). FEI<sub>T</sub> values are calculated in accordance with ANSI/AMCA Standard 208 and are based on default motor efficiencies (Belt Driven type). FEI<sub>T</sub> values for fans with specific motors will vary slightly from those shown. Fan speed shown in RPM.

# KRUGER GROUP (VENTILATION)

## THAILAND (Regional HQ)

KRUGER VENTILATION INDUSTRIES ASIA CO. LTD.  
30/159 Moo 1, Sinsakorn Industrial Estate,  
Chetsadawithi Road, Khok Kham Mueng, Samuthsakorn 74000, Thailand  
Tel: +662 1054298 Fax: +662 0248256-9  
Website: www.krugerfan.com

## THAILAND

KRUGER VENTILATION IND. (THAILAND) CO. LTD.  
30/105 Moo 1, Sinsakorn Industrial Estate,  
Chetsadawithi Road, Khok Kham Mueng, Samuthsakorn 74000, Thailand  
Tel: +662 1050399 Fax: +662 1050370-2  
Email: mktg@kruger.co.th

## INDIA

KRUGER VENTILATION INDUSTRIES (INDIA) PVT. LTD.  
Kruger Centre, Mumbai-Nasik Highway,  
Kalamgaon, Shahapur, Thane 421601, Maharashtra, India  
Tel: +91 9960558899/9975577211  
Email: sales@krugerindia.com

## INDIA (NORTH)

KRUGER VENTILATION INDUSTRIES (NORTH INDIA) PVT LTD  
Village Rohad, Tehsil Bahadurgarh, Jhajjar, Haryana-124507  
Tel: +91-9958991652/9958991660/8586966303  
Fax +91-1276-278096  
Email: sales.kni@krugerindia.com , service@krugerindia.com

## KOREA

NEOMATE CO. LTD.  
2-1010, Ace High Tech City B/D, 775 Gyeongin-ro,  
Yeongdeungpo-gu, Seoul, Korea. Postal Code 07299  
Tel: +82-2-2679-2052 Fax: +82-2-2679-2174  
Email: y7890@neomate.co.kr

## MYANMAR

KRUGER VENTILATION (MYANMAR) CO. LTD.  
Room No. F21, Thiri Yadanar Whole Sale Market, (Htawunbe)  
Toe Chae Ward, North Okkalapa Township, Yangon.  
Tel: +959 763141081/2/3  
Email: htoon@krugermm.com

## SINGAPORE

KRUGER ENGINEERING PTE. LTD.  
No. 10 Buroh Street #06-06, West Connect Building,  
Singapore 627564  
Tel: +65 68631191 Fax: +65 68631151  
Email: mktg@krugerasia.com

## AUSTRALIA

S&P KRUGER AUSTRALIA PTY. LTD.  
2 Cunningham St, Moorebank N.S.W. 2170  
Tel: +61 2-98227747  
Fax: +61 2-98227757  
Email: info@sandpkruger.com.au

## DUBAI

KRUGER VENTILATION INDUSTRIES, GULF BRANCH.  
Jebel Ali Free Zone Area (JAFZA) P.O. Box No. 262949, Dubai, UAE  
Tel: +971 4 8819188/8832017  
Fax: +971 4 8832018  
Email: johncs@krugerasia.com

## INDONESIA

P.T. KRUGER VENTILATION INDONESIA.  
JL. Teuku Umar No.20,  
Karawaci - Tangerang 15115, Indonesia  
Tel: +62 21-5512288/5513557 Fax: +62 21-5513502  
Email: mktg@krugerindo.co.id

## CHINA (GUANGZHOU)

GUANGZHOU KRUGER VENTILATION CO. LTD.  
No. 9 Huahui Road, Huashan, Huadu,  
Guangzhou, P.R. China 510880  
Tel: +86 20-66356635 Fax: +86 20-86786001/86786500  
Email: gzkruiger@krugergz.com

## CHINA (TIANJIN)

TIANJIN KRUGER VENTILATION CO. LTD.  
Jingjin Science and Technology Park  
Wuqing District, Tianjin, China  
Tel: +86 22-22143480/3481 Fax: +86 22-22143482  
Email: krugertj@krugertj.com

## CHINA (SHANGHAI)

SHANGHAI KRUGER VENTILATION CO.,LTD.  
No.500 Yuanguo Road, Anting, Jiading District,  
Shanghai 201814, P.R. China  
Tel: +86 21-69573266 Fax: +86 21-69573296  
Email: shkruger@krugerchina.com

## CHINA (WUHAN)

WUHAN KRUGER VENTILATION CO. LTD.  
No. 805, Huian Ave, Dongxihu District, Wuhan, Hubei, P.R. China 430040  
Tel: +86 27- 83248840/83060522/83097505  
Fax: +86 27- 83261886  
Email: whkruger@krugerwh.com

## HONG KONG

KRUGER VENTILATION (HONG KONG) LIMITED.  
Flat C, 9/F, Yeung Yiu Chung (No.8) Industrial Building,  
20 Wang Hoi Road, Kowloon Bay, Kowloon, Hong Kong  
Tel: +852 22469182 Fax: +852 22469187  
Email: info@kruger.com.hk

## TAIPEI

KRUGER VENTILATION (TAIWAN) CO. LTD.  
No. 157, Ping-an Rd, Hengfeng Village,  
Dayuan Shiang Taoyuan County 337, Taiwan  
Tel: +886 3-3859119 Fax: +886 3-3859118  
Email: sales@krugertwn.com.tw

## MALAYSIA

KRUVENT INDUSTRIES (M) SDN. BHD.  
Lot 850, Jalan Subang 7, Taman Perindustrian Subang,  
47500, Subang Jaya, Selangor D.E.  
Tel: +603 80743399 Fax: +603 80743388  
Email: mktg@kruger.com.my

## PHILIPPINES

KRUGER M & E INDUSTRIES CORPORATION  
B3 Welborne Industrial Park  
Banca Carmona Cavite 4116, Philippines  
Tel: +63-2-7 6223260 \* +63-46 4129652  
HP: +63 925 8018444  
Email: mktg@krugerph.net

## VIETNAM

KRUGER VENTILATION INDUSTRIES (VIETNAM) CO. LTD.  
Lot A7. 2-4, C2 Road, Thanh Thanh Cong IZ,  
Trang Bang Dist. Tay Ninh Province, Vietnam  
Tel: +84-276 3585200/01/02 Fax: +84-276 3585199  
Email: mktg@krugervn.com



**KRUVENT INDUSTRIES (M) SDN. BHD.**

Lot 850, Jalan Subang 7, Taman Perindustrian Subang, 47500,  
Subang Jaya, Selangor D.E.

Tel: +603 80743399 Fax: +603 80743388

Website: [www.krugerfan.com](http://www.krugerfan.com)

**CAT041.E0.KVM** November 2023

**A member of**

