

KRUGER

Tubular Centrifugal Mixed Flow Inline Fan MXC Series



Energy (W) Efficient



Powerful



Low Noise



Why KRUGER ?

KRUGER has been a leading innovator and manufacturer of residential, commercial and industrial fan application solutions across Asia since 1985. Today with a direct presence in over 18 regions throughout Asia; world class R&D and manufacturing facilities; KRUGER are able to offer their customers unparalleled service and support at a local level. Our customers place their trust in KRUGER.



What is a KRUGER Mixed Flow fan ?

The MXC Mixed Flow series from KRUGER combines the benefit of a high airflow volume axial fan with the static pressure development of a centrifugal fan. This combination offers an optimised energy efficient and low noise solution for many commercial and industrial ventilation applications.

Why use a KRUGER MXC Mixed Flow fan ?

High efficiency performance ►►► Energy (W) saving ►►► Lower operating costs
Peak total operating efficiencies of +77% with AMCA FEI levels >1.1

Low noise ►►► Optimised dynamic balancing and vibration control ►►► Increased product life
KRUGER MXC Series offer one of the lowest noise / cfm in the industry.

Compact size ►►► Smaller ducts ►►► Lower installation costs

MXC Series offers a more compact sized extract or supply ventilation solution to comparable axial or centrifugal fans.

Versatile design ►►► Suitable for many ventilation applications ►►► Installation friendly

Suitable for the extract (or supply) of clean, grease laden or high temperature (up to F400) airstreams.

The below table shows the sound power (LwA) and the total efficiency of the KRUGER MXC mixed flow fan versus comparable tubular centrifugal and vane axial fans.

The MXC Series generates the lowest sound levels and highest fan total efficiency across a wide range of operating points.

Performance	Fan Size	Total Efficiency			Sound Power (LwA)		
		Mixed Flow	Vane Axial	Tubular Centrifugal	Mixed Flow	Vane Axial	Tubular Centrifugal
30,000 CMH@ 500 Pa	1000	75%	70%	57%	91	106	93
30,000 CMH@ 750 Pa	1000	77%	68%	58%	93	103	98
30,000 CMH@ 1000 Pa	1000	76%	62%	61%	95	106	100

Fan size comparisons based on closed tube diameters.

Typical Ventilation Applications

● **OFFICE BUILDING**

SMOKE SPILL 
(STAIRWAY/CORRIDOR)

● **APARTMENT/CONDOMINIUM**

SMOKE SPILL 
(STAIRWAY/CORRIDOR)

● **COMMERCIAL BUILDING**

VENTILATION SUPPLY
/EXHAUST

● **COMMERCIAL AREA**

KITCHEN EXHAUST
/SUPPLY FOR RESTAURANT
IN COMMERCIAL

● **UNDERGROUND PARKING**

SUPPLY FAN/EXHAUST (SMOKE SPILL) 

Smoke Spill Fan



Summary of key standard MXC Series specifications:

A- Nominal fan diameter sizes from 315-2000mm.

B- Airflow and static pressure performance ranges up to 230,000 CMH and 2,000 Pa.

C- Airstream operating temperatures

Clean air standard ventilation applications -20°C to +55°C.

Commercial kitchen (grease laden air) applications up to +55 °C /131 °F.

High temperature smoke spill applications (MXC-D) up to 400°C/2hrs certified.

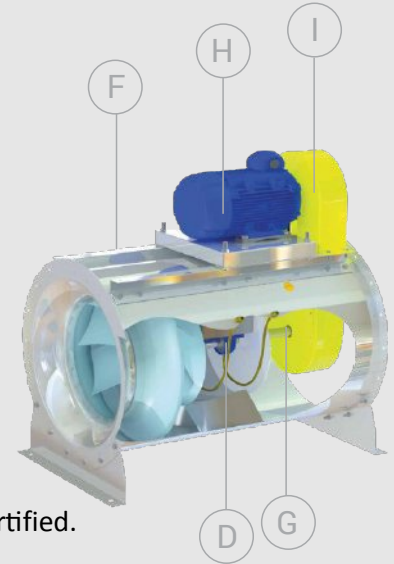

D- Extended operating life

Sealed bearings designed for $L_{10} > 75,000$ operating hours at maximum speed. Extended operating life construction of $L_{10} > 200,000$ operating hours available upon request. Vibration balanced to G2.5 in accordance with ISO14694/AMCA 204 standards.

E- Certifications



Kruvent Industries (M) Sdn. Bhd. certifies that the MXC Series shown herein is licensed to bear the AMCA seal. The ratings shown are based on tests and procedures performed in accordance with AMCA Publication 211 and AMCA Publication 311 and comply with the requirements of the AMCA Certified Ratings Program.



High temperature (up to 400°C/2hrs) in accordance with EN12101-3 certification by TÜV SÜD a third-party globally renowned testing and certification organisation.

Class	Temperature (°C)	Minimum functioning period (minutes)
F _r 250	250	120
F300	300	60
F _r 300	300	120
F400	400	120

F- Materials and Coatings

All MXC casing and parts are all manufactured from galvanized steel (size 315-1120) and finished with a zinc primer and tough polyester coating finish (size 1250-2000). The polyester coating finish is salt-spray rated up to 1000hrs in accordance with ASTM B117 testing standards. Suitable for use in Indoor or Outdoor environments.

G- High precision shafts (Belt Drive)

All belt drive shafts are manufactured from C45 grade steel and high precision G6 tolerance (ISO286-2) to minimise vibration and extend life.

H- High Efficiency KRUGER Motors

All MXC Series fans are supplied with a wide variety of both 1PH and 3PH AC, PM and EC, Standard and High Temperature rated motors. Please ask local KRUGER Distributor.

I- Safety features

All belt-drive MXC models include a robust wire safety belt guard as standard. Optional inlet and outlet safety guards are available on request.

Options and Accessories

- a - Inlet and outlet duct connection flanges to connect circular duct to MXC flanges.
- b - Circular flexible duct connectors, both standard and high temperature variations (up to F400).
- c - Inlet and outlet safety guards.
- d - Belt cover isolates drive sets from airstream and protection from rotating pulleys and belts.
- e - Casing access door for easy of cleaning of fan internals.
- f - Vibration isolator mounts for floor or ceiling mounted installations.
- g - Extended lubrication lines (Belt Drive) for bearing maintenance.
- h - A drain coupling can be attached to the bottom of housing.
- i - Special coatings for specialist corrosion application protection.
- j - Spark resistance construction, per AMCA Standard 99.

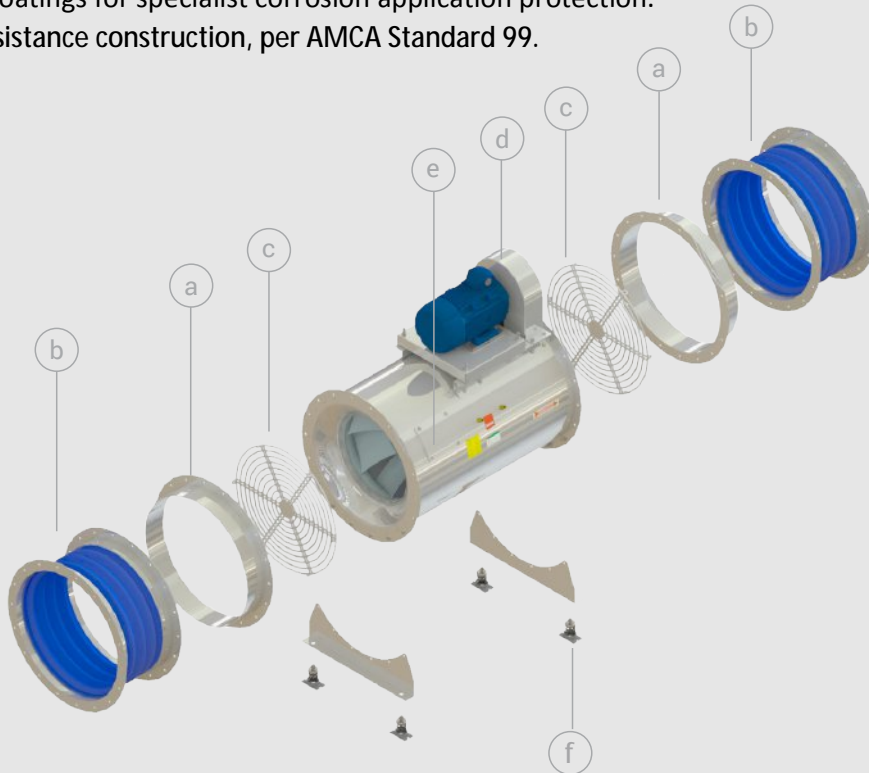

Installation and Mounting

All MXC Series models can be mounted in either horizontal or vertical orientation. All models include provision (fixing locations) for floor or ceiling mounting.

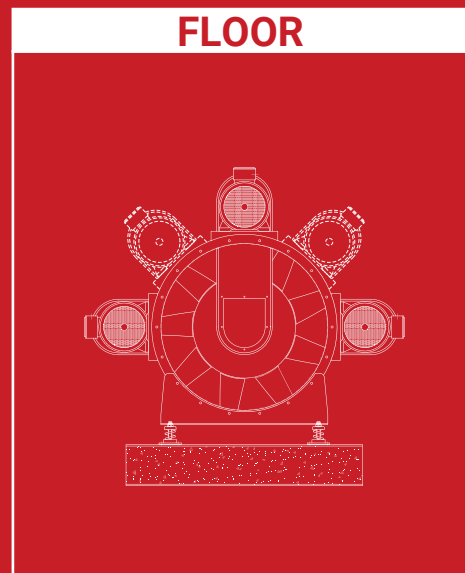
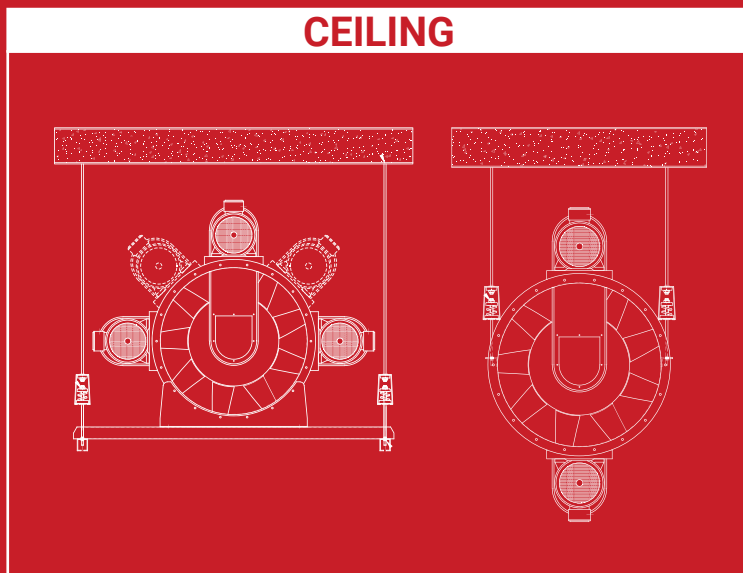

Model number nomenclature

MXC 1000 - D - N

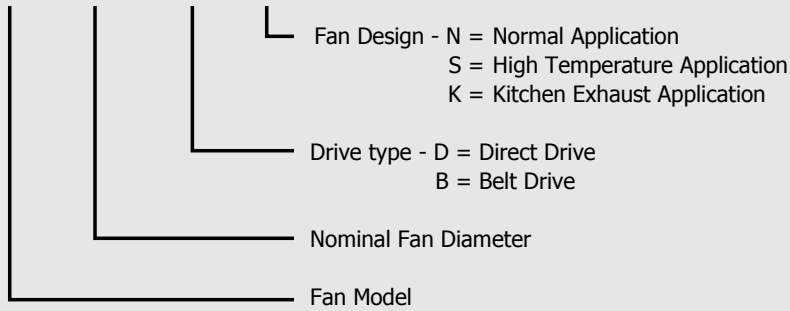

Dimensions – Direct drive models

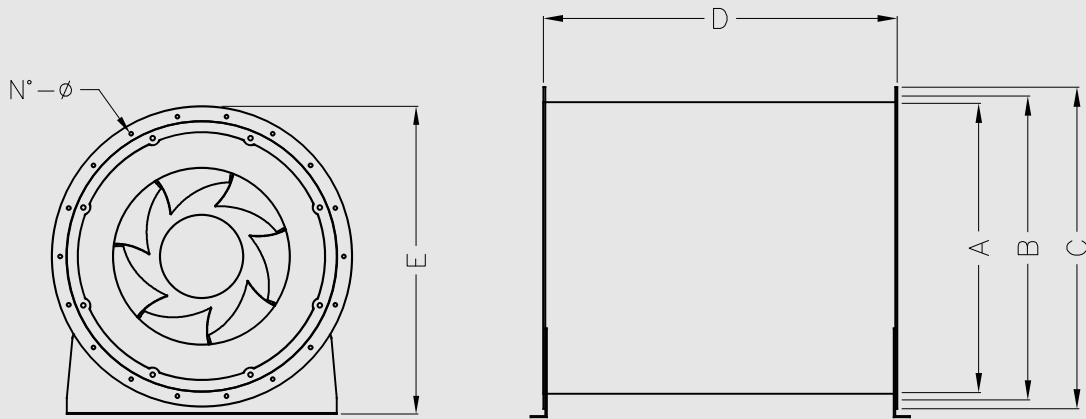

Model	A	B	C	D	E	N°	Ø	Weight* (kg)	Max Motor Frame Size*
315	315	355	395	500	406	8	10	32	71
355	355	395	435	560	455	8	10	40	71
400	400	440	480	630	502	12	10	48	80
450	450	490	530	630	553	12	10	55	90
500	500	540	580	710	608	12	10	71	100
560	560	605	660	800	680	12	10	92	112
630	630	675	730	900	805	12	10	115	132
710	710	755	810	1000	837	18	12	184	132
800	800	845	900	1000	926	18	12	214	160
900	900	945	1000	1100	1026	18	12	261	180
1000	1000	1050	1100	1250	1130	24	12	347	200
1120	1120	1186	1250	1400	1230	24	12	443	225
1250	1250	1315	1380	1400	1412	24	12	682	225
1400	1400	1465	1530	1600	1562	32	14	764	250
1600	1600	1663	1730	1800	1790	32	14	873	280
1800	1800	1256	1930	2240	2005	32	14	982	315
2000	2000	2073	2130	2240	2220	32	14	1091	315

* Weight without motor

** Please consult KRUGER for motor frame size other than specified

All dimension in mm.

Dimensions – Belt drive models

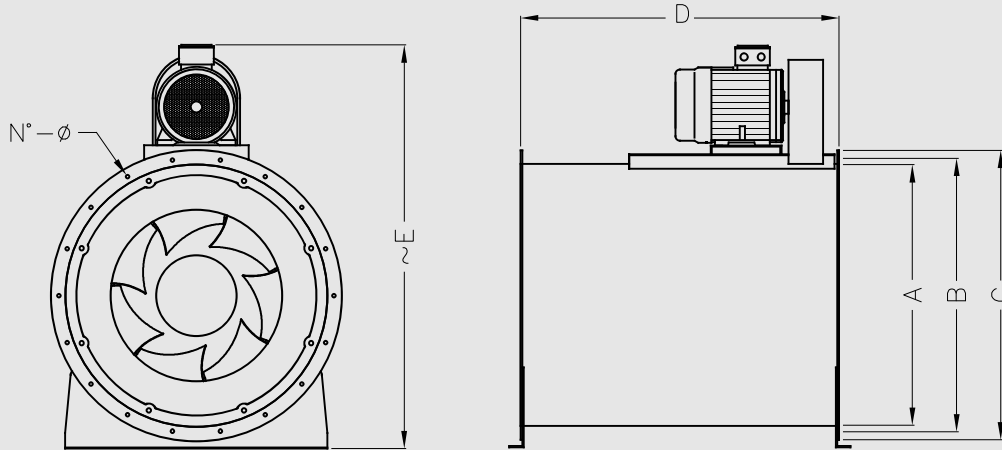

Model	A	B	C	D	E	N°	Ø	Weight* (kg)	Max Motor Frame Size**	Moment of Inertia of Wheel (kgm ²)
315	315	355	395	500	600	8	10	36	90	0.023
355	355	395	435	560	650	8	10	44	100	0.040
400	400	440	480	630	720	12	10	53	112	0.065
450	450	490	530	630	765	12	10	60	112	0.102
500	500	540	580	710	890	12	10	78	112	0.190
560	560	605	660	800	990	12	10	101	132	0.315
630	630	675	730	900	1065	12	10	125	160	0.525
710	710	755	810	1000	1245	18	12	195	160	0.961
800	800	845	900	1000	1256	18	12	225	160	1.75
900	900	945	1000	1100	1395	18	12	273	180	3.17
1000	1000	1050	1100	1250	1515	24	12	360	200	4.98
1120	1120	1186	1250	1400	1665	24	12	460	225	7.60
1250	1250	1315	1380	1400	1845	24	12	702	225	14.23
1400	1400	1465	1530	1600	2120	32	14	786	250	23.93
1600	1600	1663	1730	1800	2445	32	14	899	280	39.8
1800	1800	1256	1930	2240	2675	32	14	1011	315	75.4
2000	2000	2073	2130	2240	3005	32	14	1123	315	119.5

* Weight without motor

All dimension in mm.

** Please consult KRUGER for motor frame size other than specified

Accessories dimensions

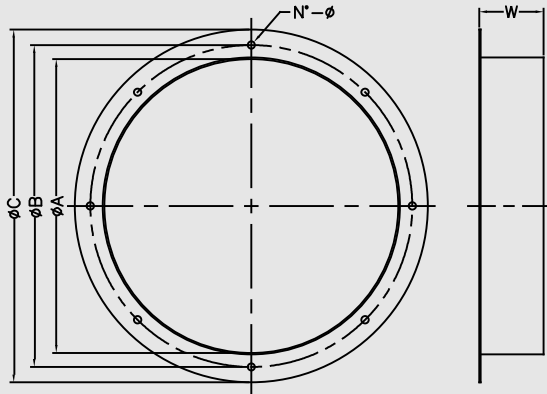

Inlet and Outlet Flanges

Model	A	B	C	W	N	ø
315	315	355	395	65	8	10
355	355	395	435	65	8	10
400	400	440	480	65	12	10
450	450	490	530	65	12	10
500	500	540	580	65	12	10
560	560	605	660	65	12	10
630	630	675	730	65	12	10
710	710	755	810	75	18	12
800	800	845	900	75	18	12
900	900	945	1000	75	18	12
1000	1000	1050	1100	75	18	12
1120	1120	1185	1250	85	24	12
1250	1250	1315	1380	85	24	12
1400	1400	1465	1530	85	32	14
1600	1600	1663	1730	85	32	14
1800	1800	1856	1930	95	32	14
2000	2000	2073	2130	95	32	14

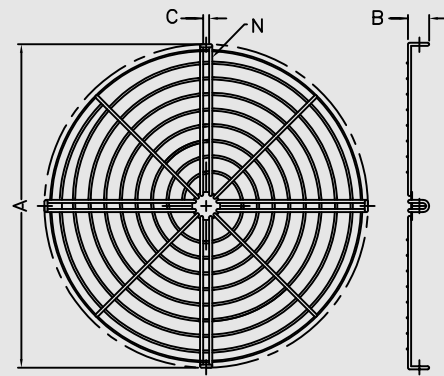

Inlet and Outlet Protection Nets

Model	A	B	C	N
315	313	25	10	4
355	353	25	10	4
400	398	25	10	4
450	448	25	10	4
500	498	25	10	4
560	558	25	10	4
630	628	25	10	4
710	708	25	10	6
800	798	25	10	6
900	898	25	10	6
1000	998	25	10	8
1120	1118	25	10	8
1250	1248	25	10	8
1400	1398	25	10	8
1600	1598	25	10	8
1800	1798	25	10	8
2000	1998	25	10	8

All dimension in mm.

Accessories dimensions

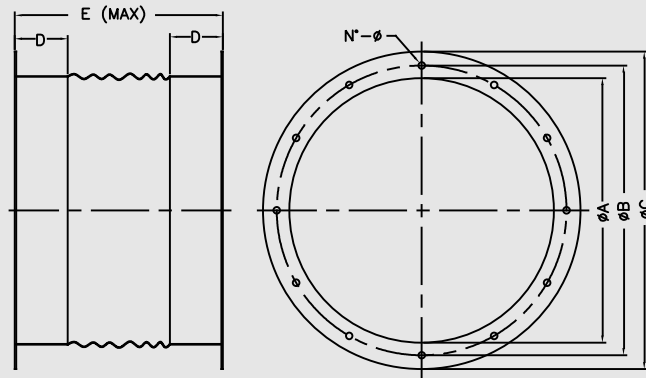

Flexible Duct

Model	A	B	C	D	E	N	ø
315	315	355	395	40	220	8	10
355	355	395	435	40	220	8	10
400	400	440	480	40	220	12	10
450	450	490	530	40	220	12	10
500	500	540	580	40	220	12	10
560	560	605	660	40	220	12	10
630	630	675	730	40	220	12	10
710	710	755	810	40	220	18	12
800	800	845	900	40	220	18	12
900	900	945	1000	40	220	18	12
1000	1000	1050	1100	40	220	18	12
1120	1120	1185	1250	40	220	24	12
1250	1250	1315	1380	40	220	24	12
1400	1400	1465	1530	40	220	32	14
1600	1600	1663	1730	40	220	32	14
1800	1800	1856	1930	40	220	32	14
2000	2000	2073	2130	40	220	32	14

All dimension in mm.

Example of Selection

- Air Volume $Q = 32115 \text{ m}^3/\text{h}$
- Outlet Velocity $V = 11.36 \text{ m/s}$
- Dynamic Pressure $P_d = 77 \text{ Pa}$
- Total Pressure $P_t = 823 \text{ Pa}$
- Fan Speed $N = 1255 \text{ rpm}$
- Absorbed Power $W = 9.52 \text{ kW}$
- Total Efficiency $\eta = 77.1\%$
- Sound Power Level $L_w(A) = 94 \text{ dB(A)}$



MXC 1000

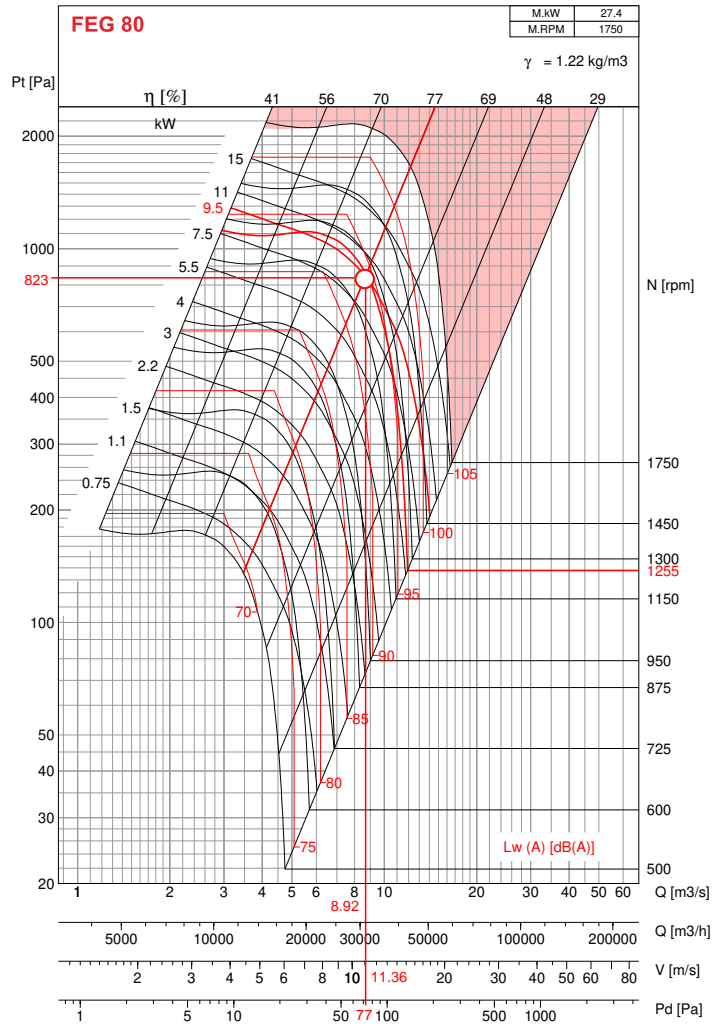

- Performance certified is for Installation type D - Ducted inlet, Ducted outlet. Performance ratings do not include the effects of appurtenances (belt cover). Power rating kW does not include transmission losses.
 - The A-weighted sound ratings shown have been calculated per AMCA International Standard 301. Values shown are for inlet Lw(A) sound power levels for installation type D - Ducted inlet, Ducted outlet. Ratings include the effects of duct end correction.



MXC 315

FEG 71

M.kW	2.9
M.RPM	5350

$\gamma = 1.22 \text{ kg/m}^3$

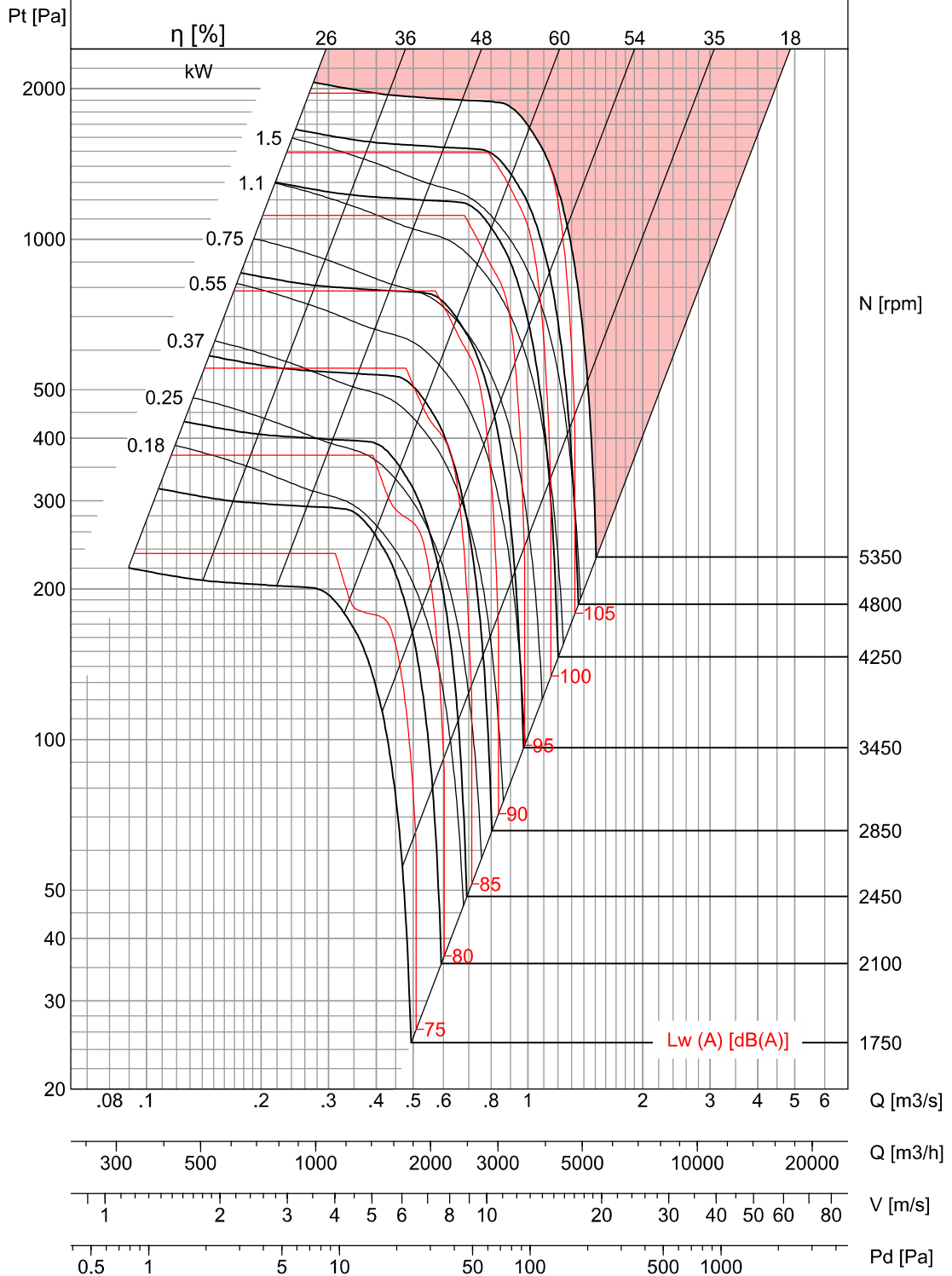

- Performance certified is for Installation type D - Ducted inlet, Ducted outlet. Performance ratings do not include the effects of appurtenances (belt cover). Power rating kW does not include transmission losses.
 - The A-weighted sound ratings shown have been calculated per AMCA International Standard 301. Values shown are for inlet Lw A sound power levels for installation type D - Ducted inlet, Ducted outlet. Ratings include the effects of duct end correction.



MXC 355

FEG 75

M.kW	3.4
M.RPM	4750

$\gamma = 1.22 \text{ kg/m}^3$

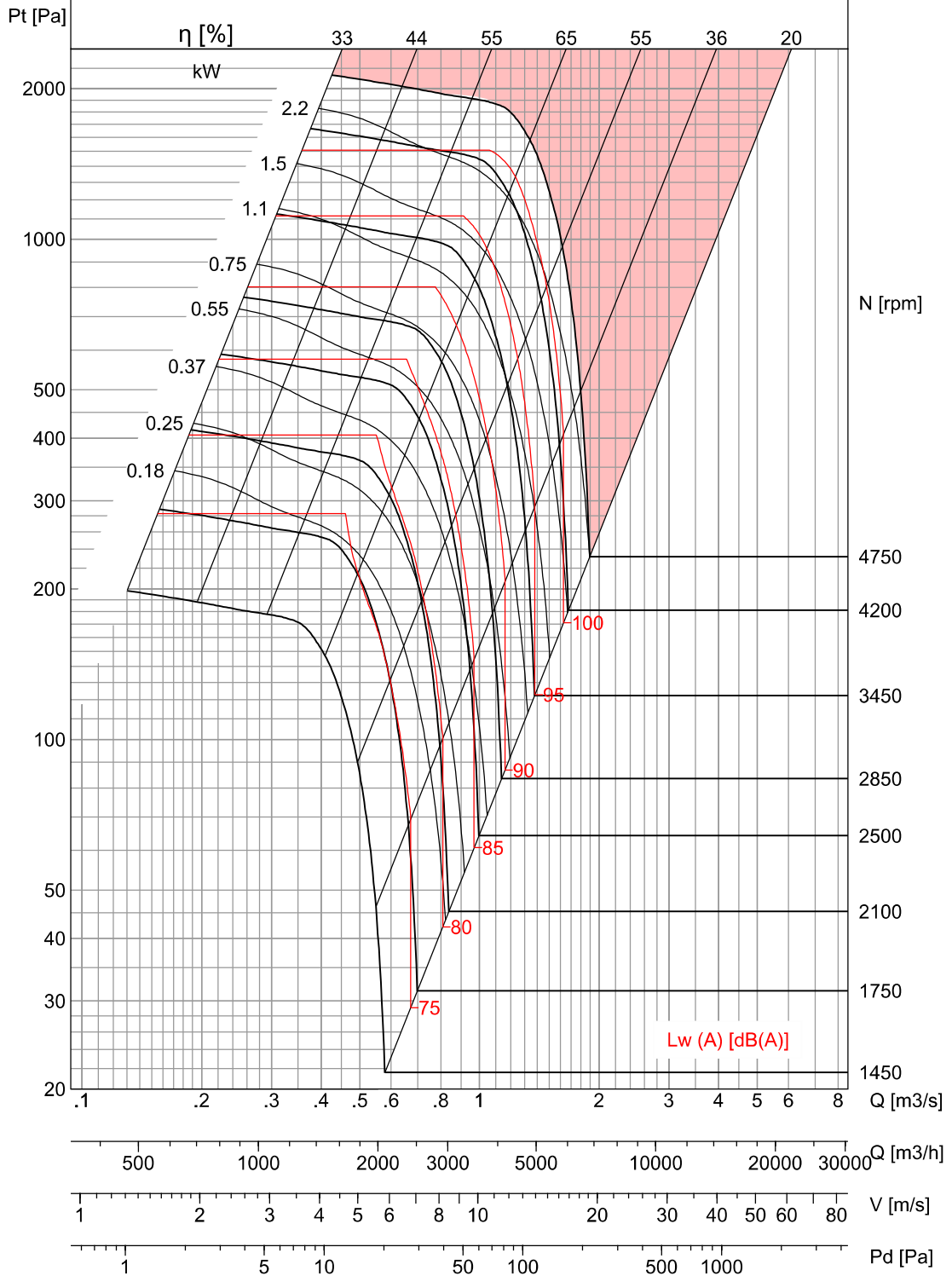

- Performance certified is for Installation type D - Ducted inlet, Ducted outlet. Performance ratings do not include the effects of appurtenances (belt cover). Power rating kW does not include transmission losses.
 - The A-weighted sound ratings shown have been calculated per AMCA International Standard 301. Values shown are for inlet Lw(A) sound power levels for installation type D - Ducted inlet, Ducted outlet. Ratings include the effects of duct end correction.



MXC 400

FEG 80

M.kW	4.1
M.RPM	4250

$\gamma = 1.22 \text{ kg/m}^3$

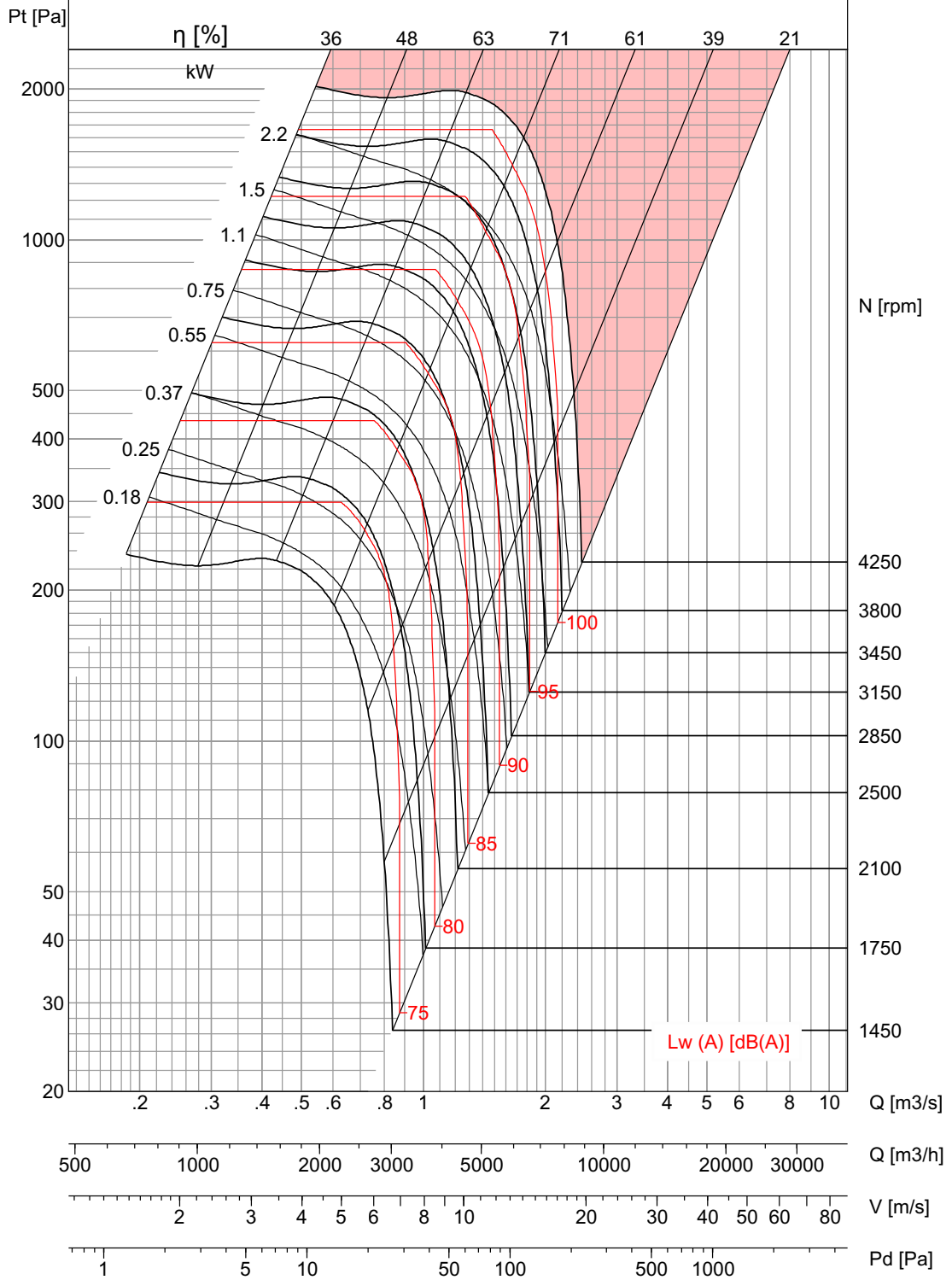

- Performance certified is for Installation type D - Ducted inlet, Ducted outlet. Performance ratings do not include the effects of appurtenances (belt cover). Power rating kW does not include transmission losses.
 - The A-weighted sound ratings shown have been calculated per AMCA International Standard 301. Values shown are for inlet Lw A sound power levels for installation type D - Ducted inlet, Ducted outlet. Ratings include the effects of duct end correction.



MXC 450

FEG 80

M.kW	5
M.RPM	3750

$\gamma = 1.22 \text{ kg/m}^3$

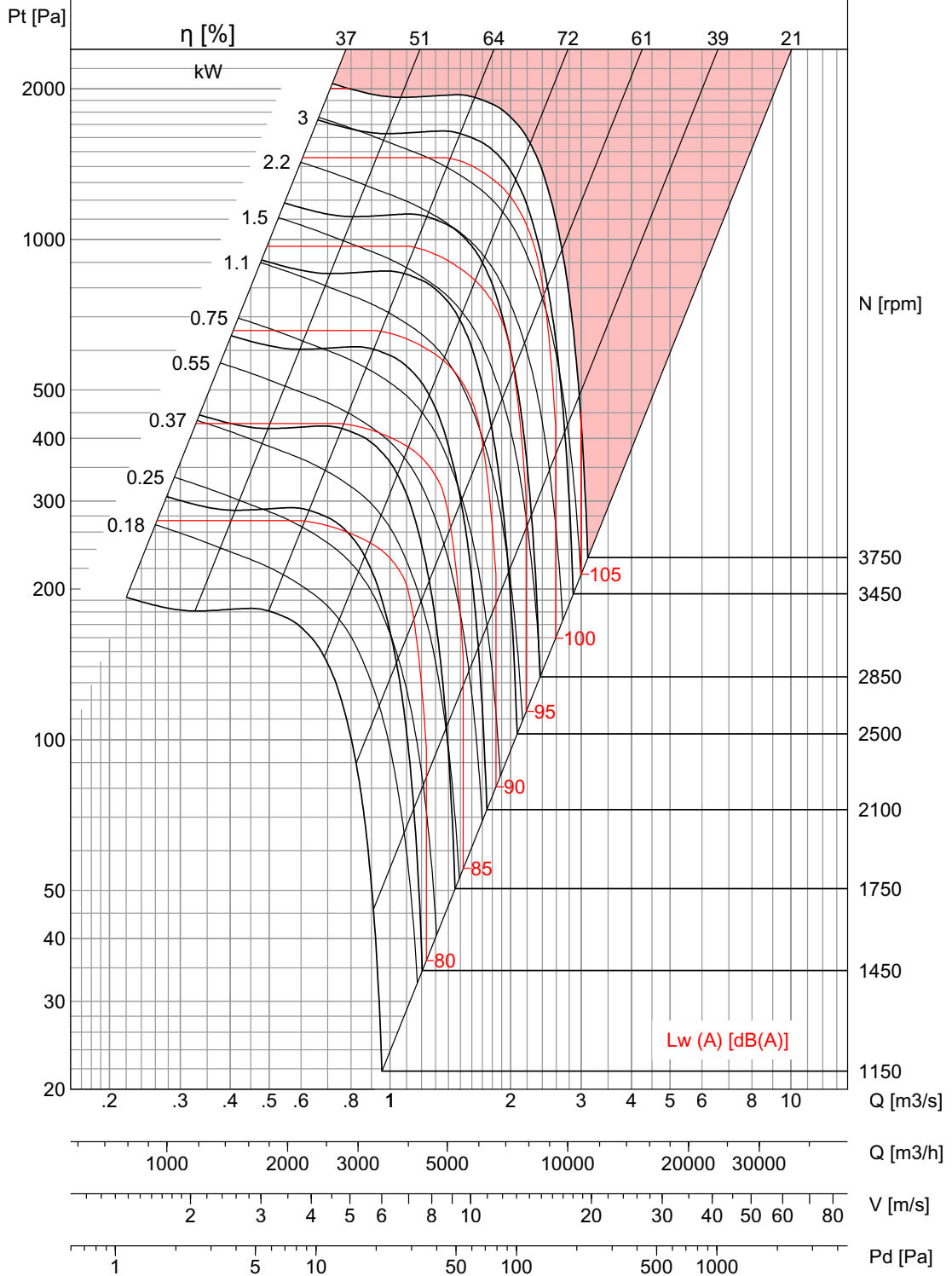

- Performance certified is for Installation type D - Ducted inlet, Ducted outlet. Performance ratings do not include the effects of appurtenances (belt cover). Power rating kW does not include transmission losses.
 - The A-weighted sound ratings shown have been calculated per AMCA International Standard 301. Values shown are for inlet Lw i A sound power levels for installation type D - Ducted inlet, Ducted outlet. Ratings include the effects of duct end correction.



MXC 500

FEG 80

M.kW	6.7
M.RPM	3450

$\gamma = 1.22 \text{ kg/m}^3$

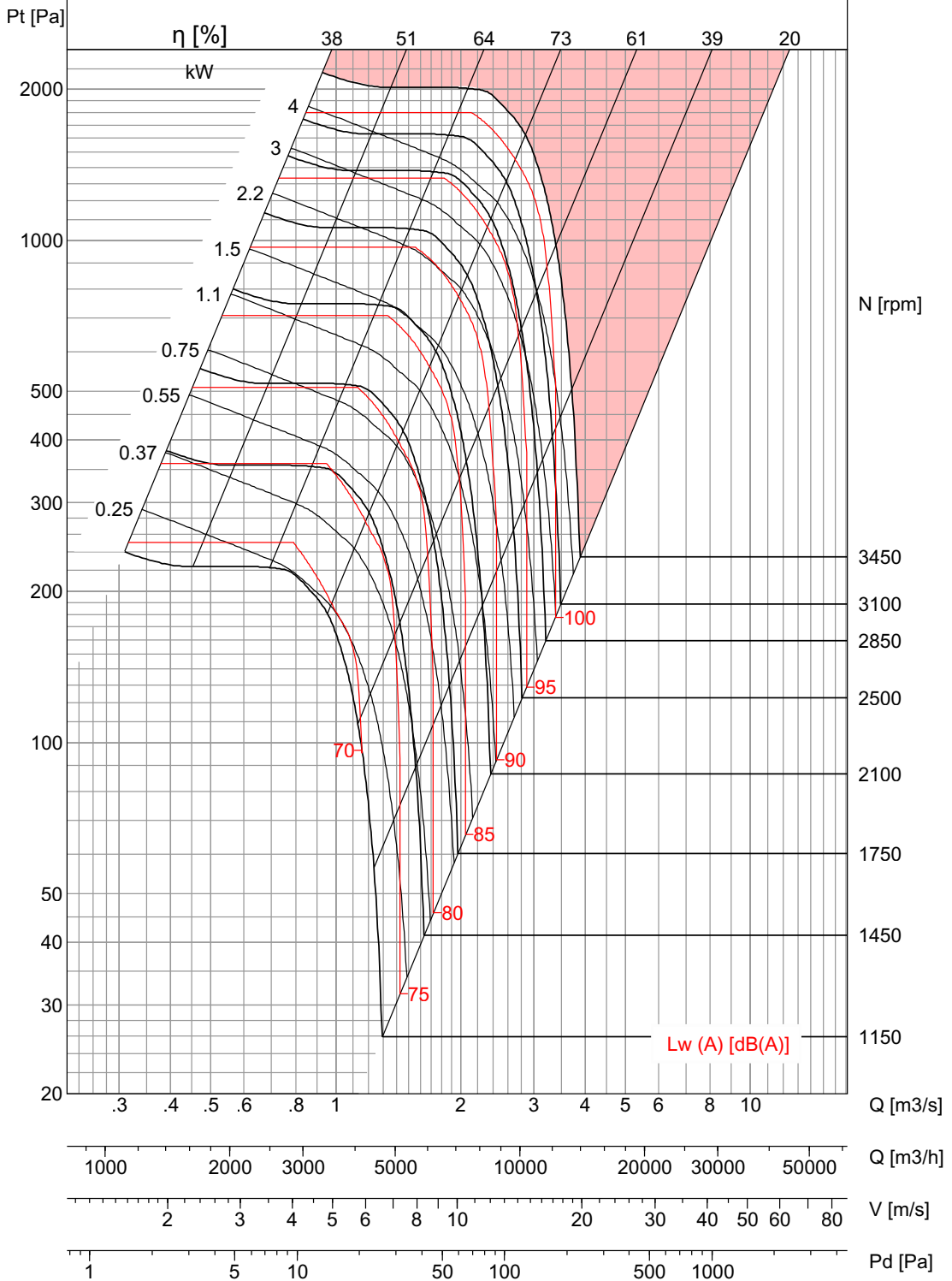

- Performance certified is for Installation type D - Ducted inlet, Ducted outlet. Performance ratings do not include the effects of appurtenances (belt cover). Power rating kW does not include transmission losses.
 - The A-weighted sound ratings shown have been calculated per AMCA International Standard 301. Values shown are for inlet Lw i A sound power levels for installation type D - Ducted inlet, Ducted outlet. Ratings include the effects of duct end correction.



MXC 560

FEG 80

M.kW	7.8
M.RPM	3000

$\gamma = 1.22 \text{ kg/m}^3$

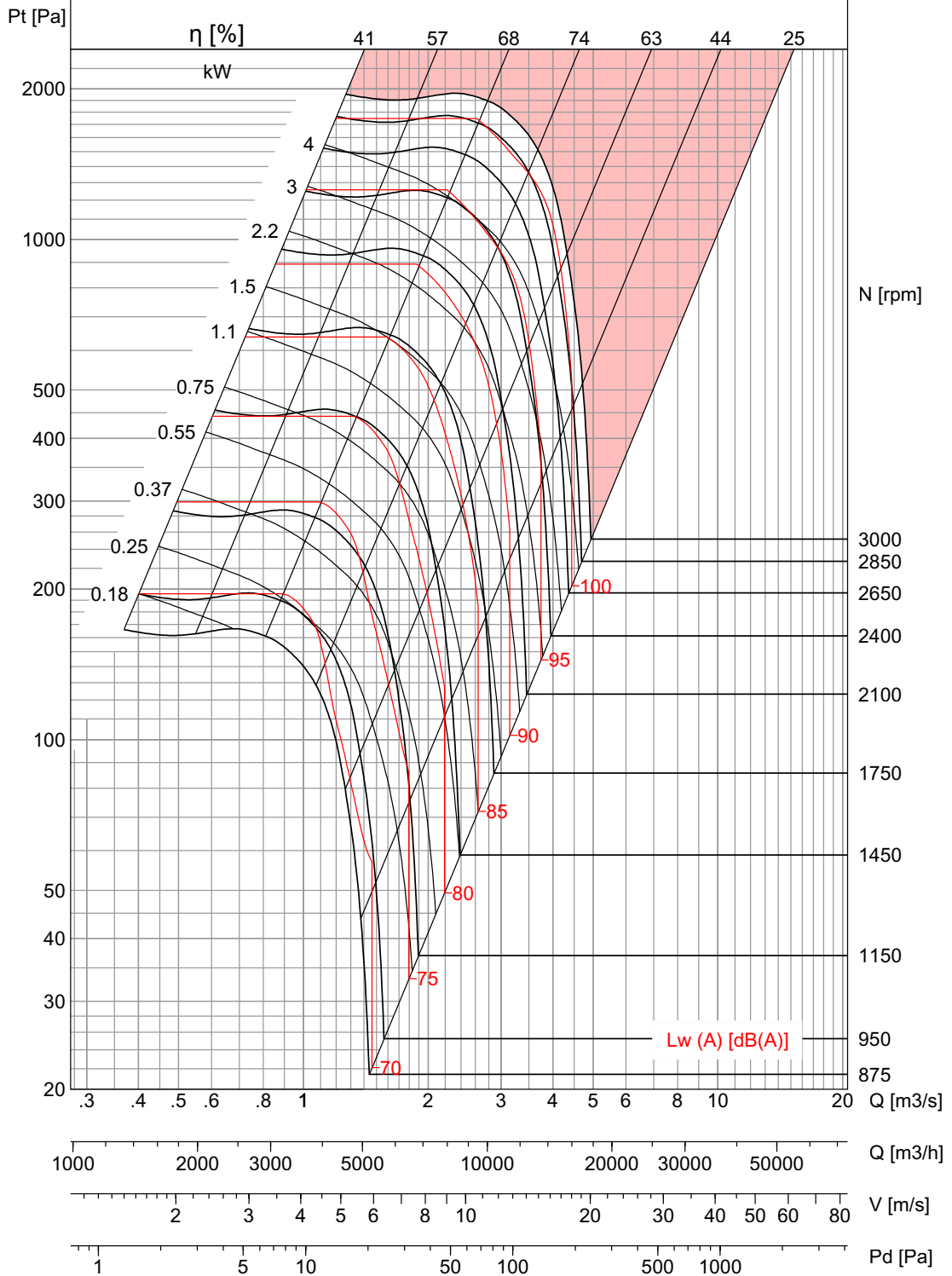

- Performance certified is for Installation type D - Ducted inlet, Ducted outlet. Performance ratings do not include the effects of appurtenances (belt cover). Power rating kW does not include transmission losses.
- The A-weighted sound ratings shown have been calculated per AMCA International Standard 301. Values shown are for inlet Lw A sound power levels for installation type D - Ducted inlet, Ducted outlet. Ratings include the effects of duct end correction.



MXC 630

FEG 80

M.kW	10
M.RPM	2700

$\gamma = 1.22 \text{ kg/m}^3$

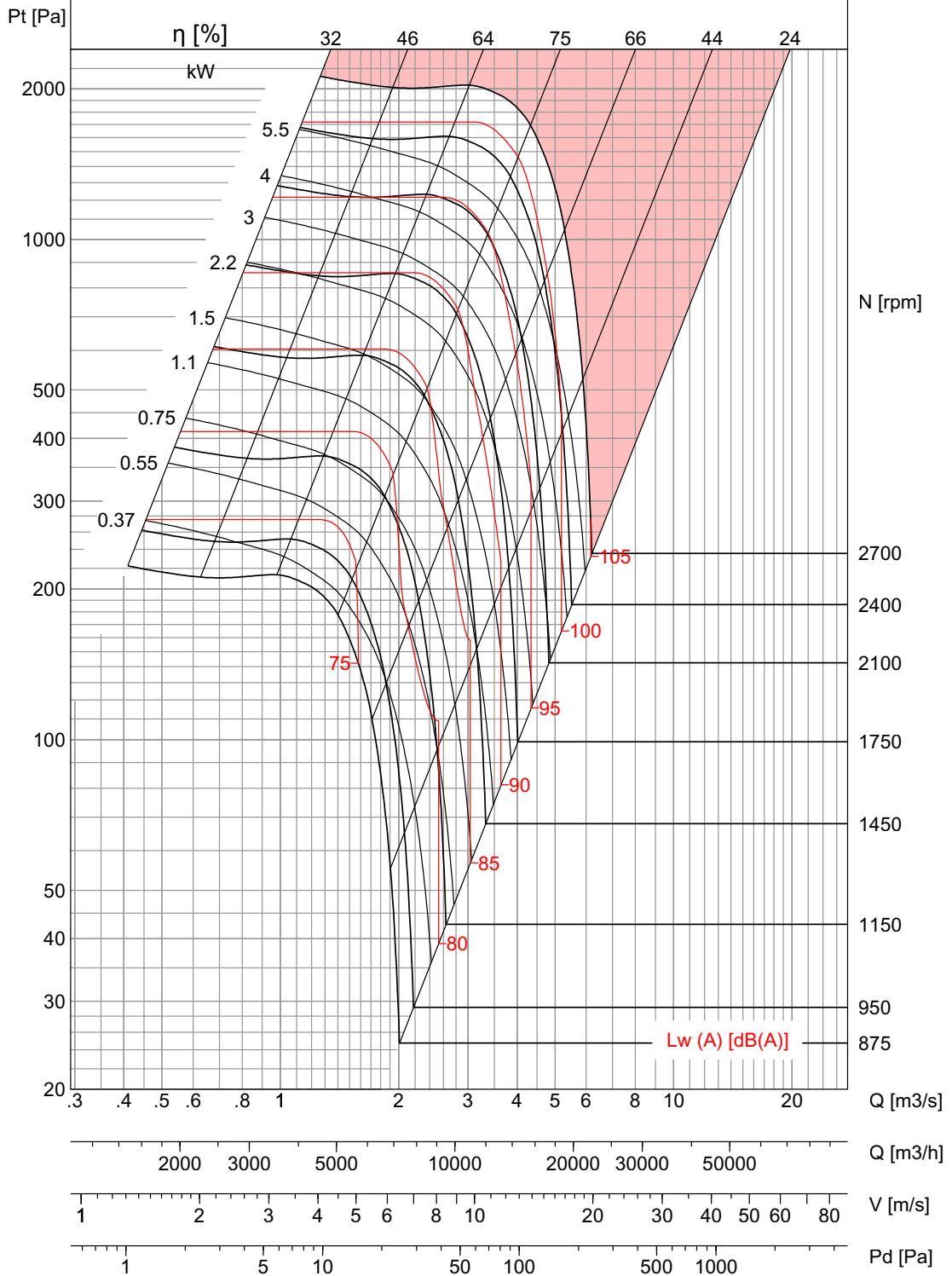

- Performance certified is for Installation type D - Ducted inlet, Ducted outlet. Performance ratings do not include the effects of appurtenances (belt cover). Power rating kW does not include transmission losses.
 - The A-weighted sound ratings shown have been calculated per AMCA International Standard 301. Values shown are for inlet Lw(A) sound power levels for installation type D - Ducted inlet, Ducted outlet. Ratings include the effects of duct end correction.



MXC 710

FEG 80

M.kW	13.1
M.RPM	2400

$\gamma = 1.22 \text{ kg/m}^3$

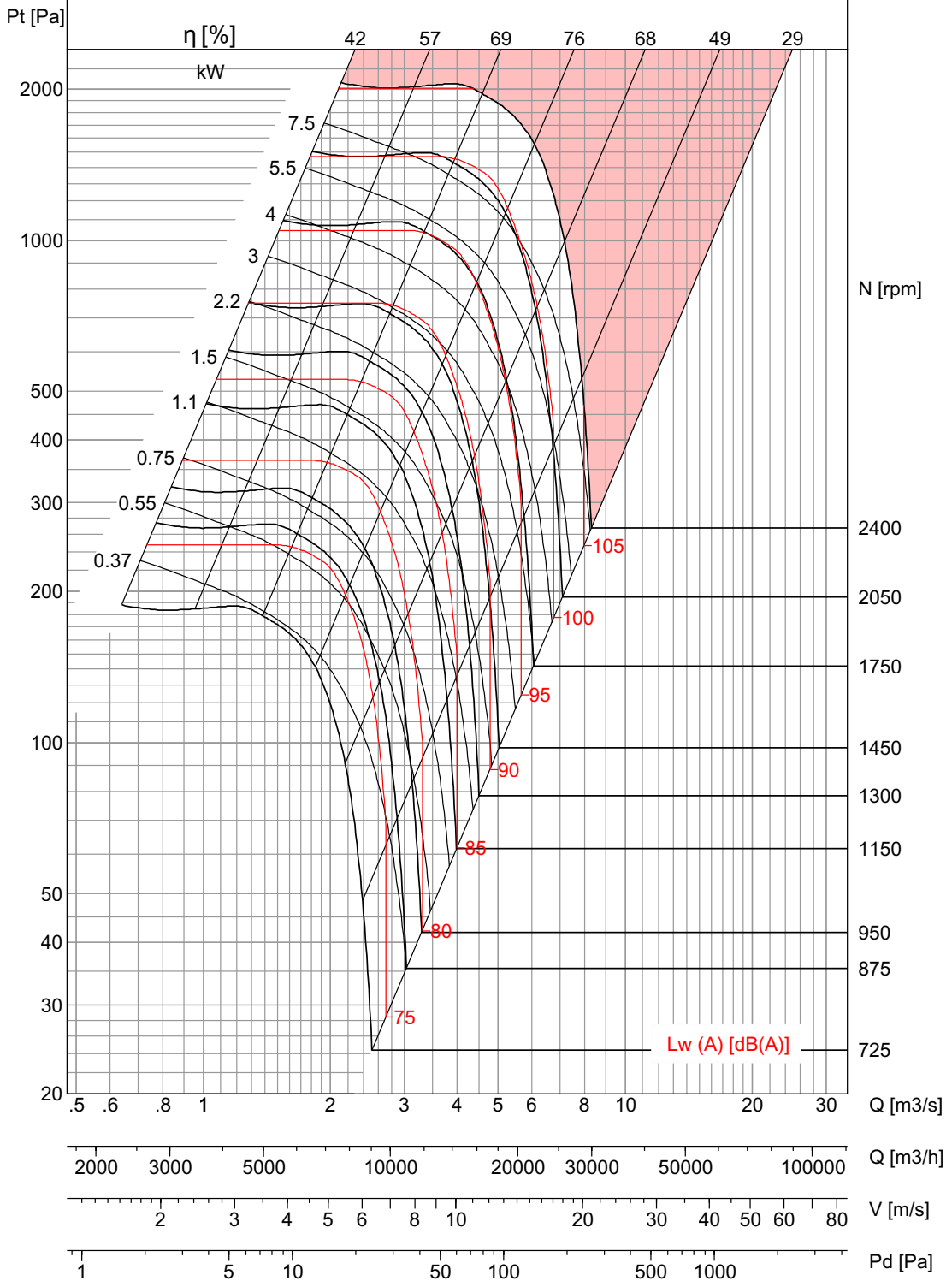

- Performance certified is for Installation type D - Ducted inlet, Ducted outlet. Performance ratings do not include the effects of appurtenances (belt cover). Power rating kW does not include transmission losses.
 - The A-weighted sound ratings shown have been calculated per AMCA International Standard 301. Values shown are for inlet Lwi A sound power levels for installation type D - Ducted inlet, Ducted outlet. Ratings include the effects of duct end correction.



MXC 800

FEG 80

M.kW	15
M.RPM	2100

$\gamma = 1.22 \text{ kg/m}^3$

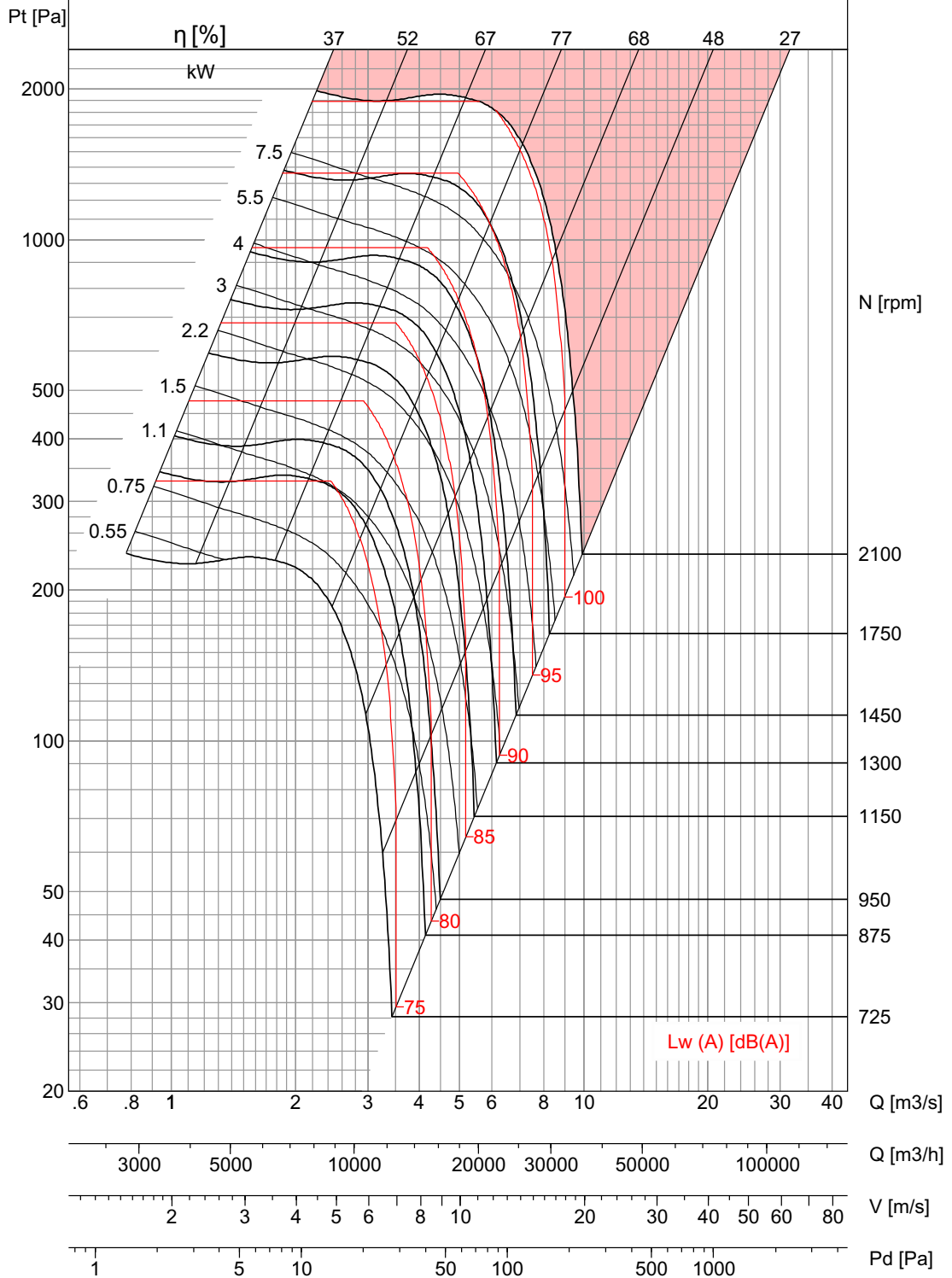

- Performance certified is for Installation type D - Ducted inlet, Ducted outlet. Performance ratings do not include the effects of appurtenances (belt cover). Power rating kW does not include transmission losses.
 - The A-weighted sound ratings shown have been calculated per AMCA International Standard 301. Values shown are for inlet Lw A sound power levels for installation type D - Ducted inlet, Ducted outlet. Ratings include the effects of duct end correction.



MXC 900

FEG 80

M.kW	20
M.RPM	1900

$\gamma = 1.22 \text{ kg/m}^3$

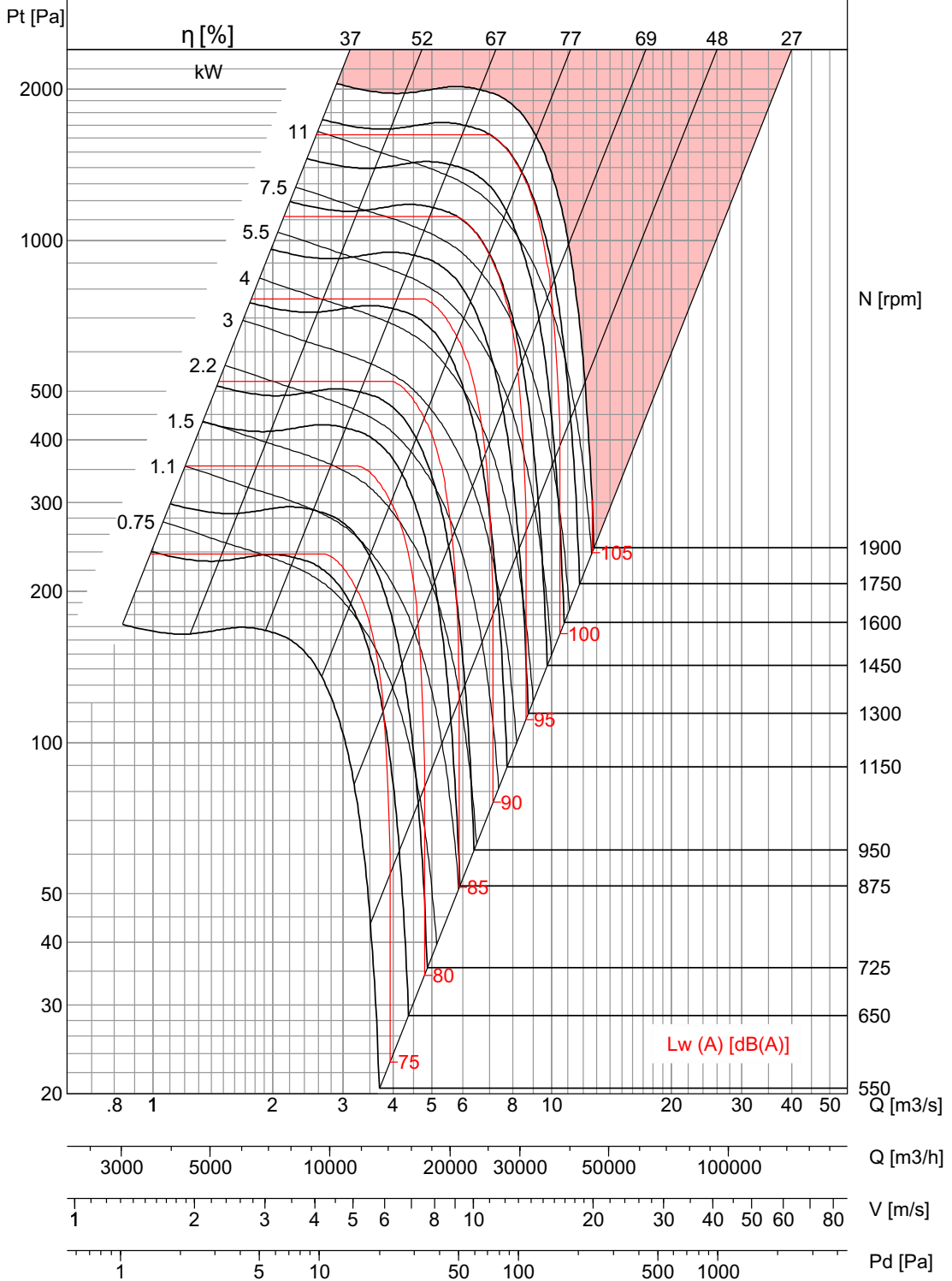

- Performance certified is for Installation type D - Ducted inlet, Ducted outlet. Performance ratings do not include the effects of appurtenances (belt cover). Power rating kW does not include transmission losses.
 - The A-weighted sound ratings shown have been calculated per AMCA International Standard 301. Values shown are for inlet Lw A sound power levels for installation type D - Ducted inlet, Ducted outlet. Ratings include the effects of duct end correction.

MXC 1000

FEG 80

M.kW	27.4
M.RPM	1750

$\gamma = 1.22 \text{ kg/m}^3$

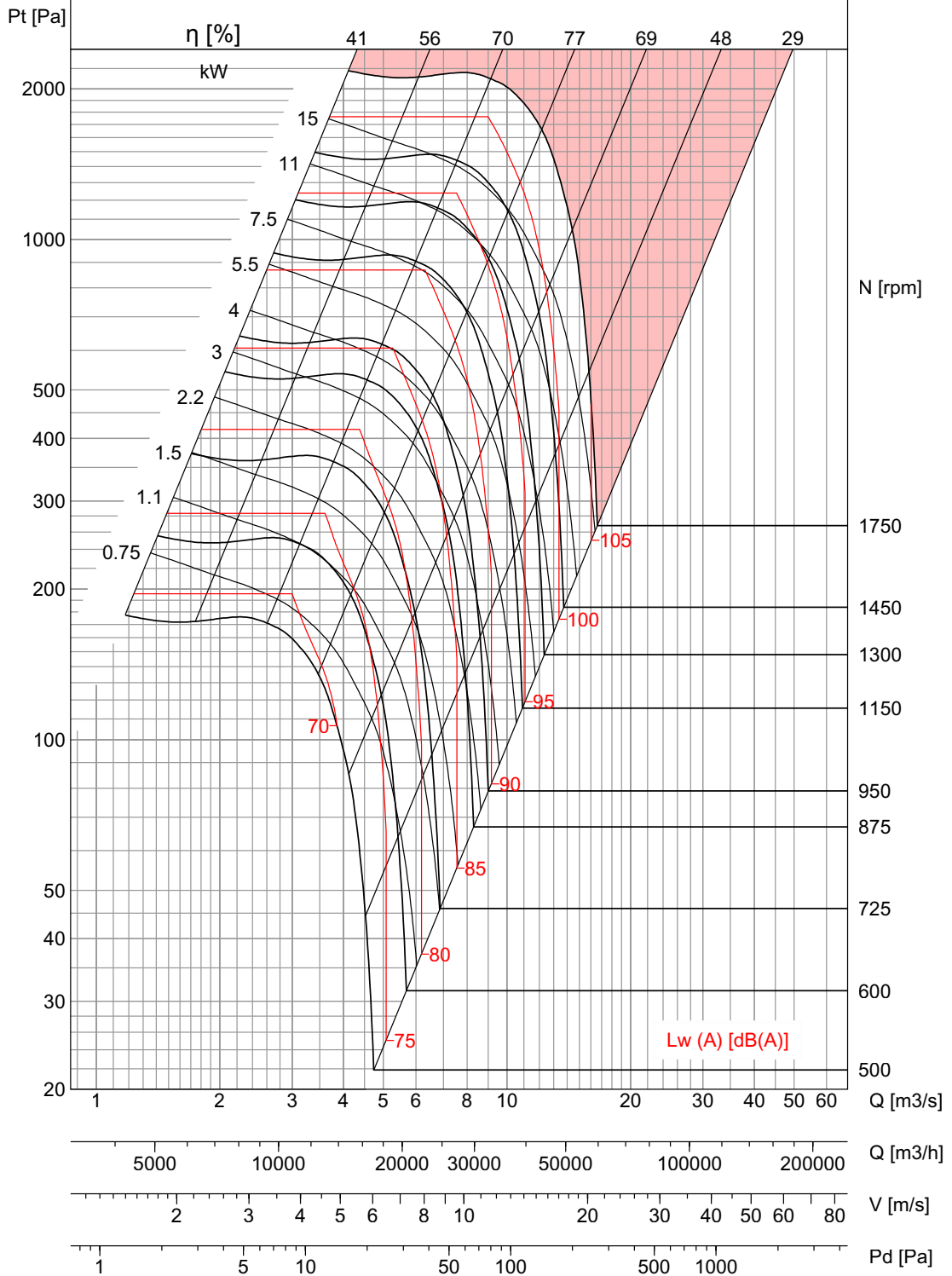

- Performance certified is for Installation type D – Ducted inlet, Ducted outlet. Performance ratings do not include the effects of appurtenances (belt cover). Power rating kW does not include transmission losses.
 - The A-weighted sound ratings shown have been calculated per AMCA International Standard 301. Values shown are for inlet Lw A sound power levels for installation type D – Ducted inlet, Ducted outlet. Ratings include the effects of duct end correction.



MXC 1120

FEG 80

M.kW	30.5
M.RPM	1500

$\gamma = 1.22 \text{ kg/m}^3$

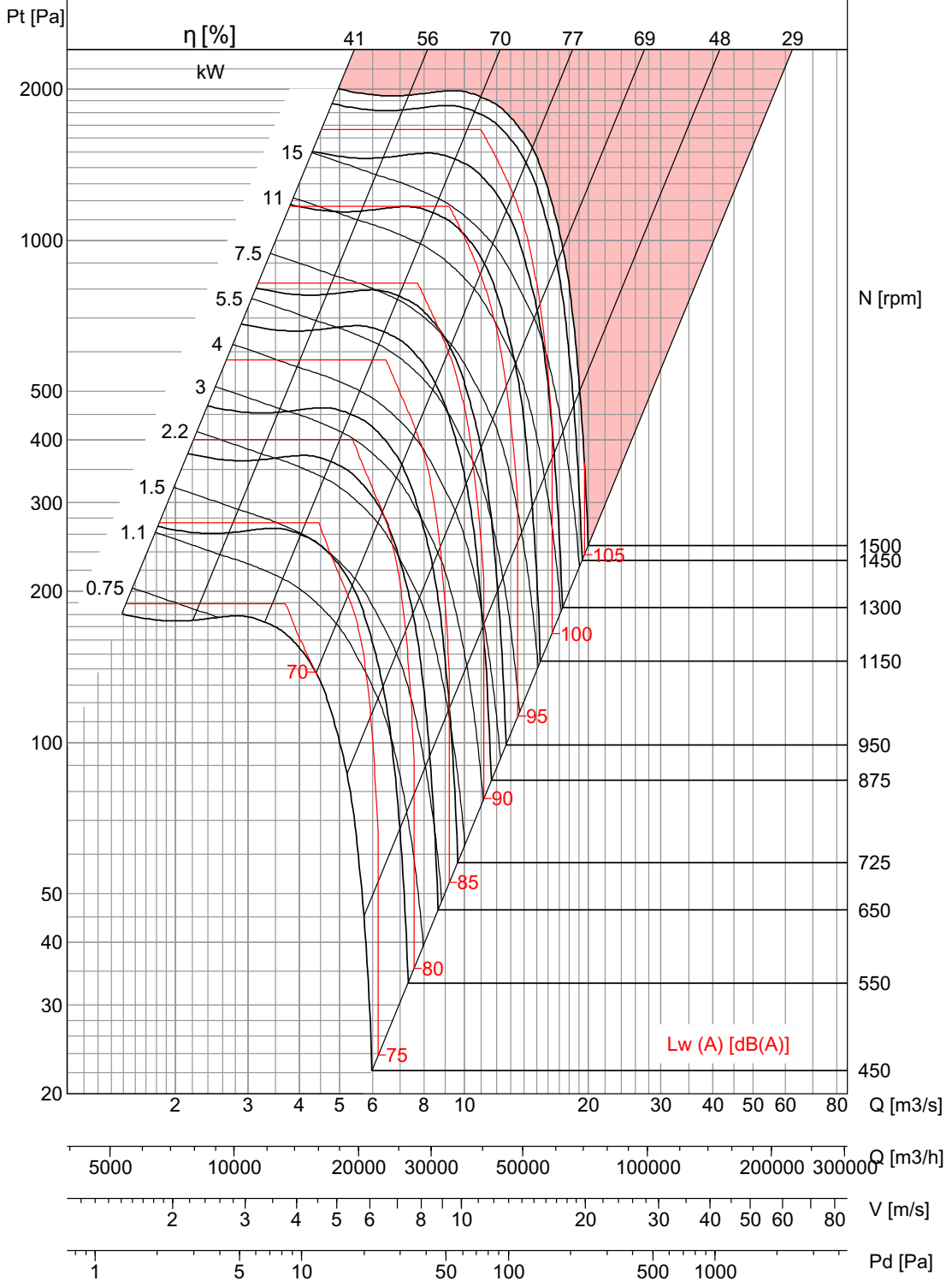

- Performance certified for Installation type D – Ducted inlet, Ducted outlet. Performance ratings do not include the effects of appurtenances (belt cover). Power rating kW does not include transmission losses.
 - The A-weighted sound ratings shown have been calculated per AMCA International Standard 301. Values shown are for inlet Lw(A) sound power levels for installation type D – Ducted inlet, Ducted outlet. Ratings include the effects of duct end correction.



MXC 1250

FEG 80

M.kW	38.5
M.RPM	1350

$\gamma = 1.22 \text{ kg/m}^3$

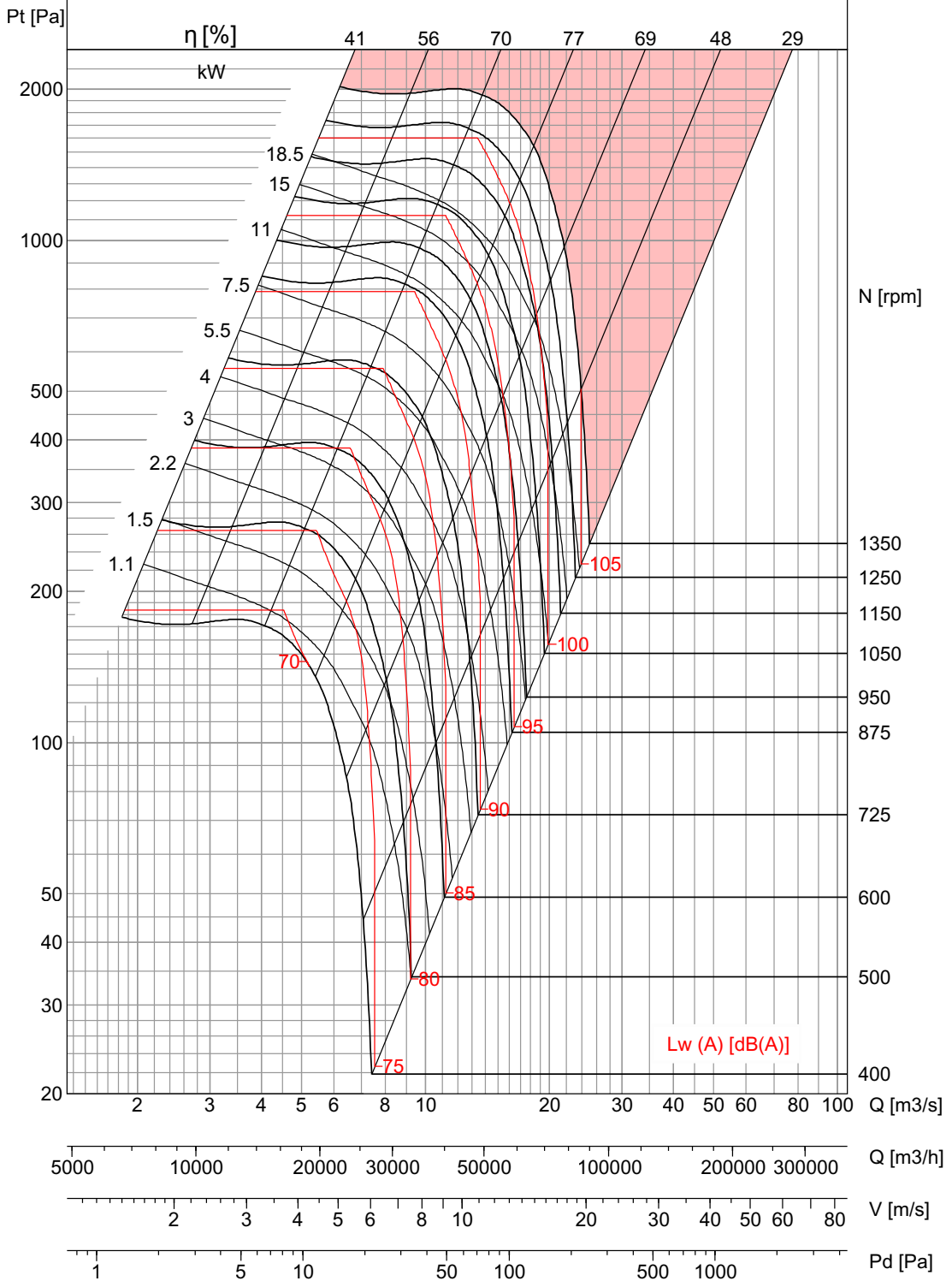

- Performance certified is for Installation type D - Ducted inlet, Ducted outlet. Performance ratings do not include the effects of appurtenances (belt cover). Power rating kW does not include transmission losses.
- The A-weighted sound ratings shown have been calculated per AMCA International Standard 301. Values shown are for inlet Lw A sound power levels for installation type D - Ducted inlet, Ducted outlet. Ratings include the effects of duct end correction.



MXC 1400

FEG 80

M.kW	47.6
M.RPM	1200

$\gamma = 1.22 \text{ kg/m}^3$

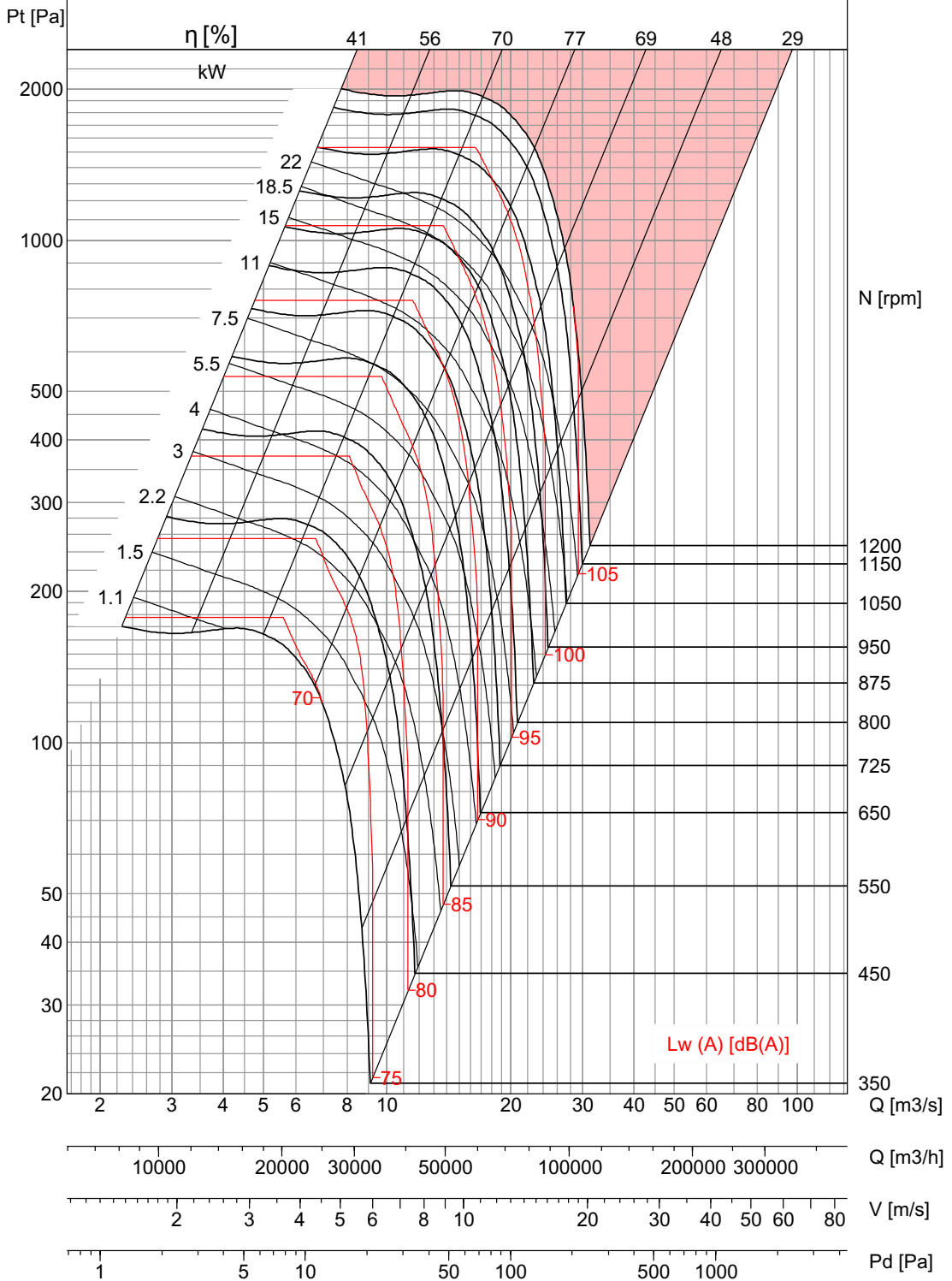

- Performance certified is for Installation type D - Ducted inlet, Ducted outlet. Performance ratings do not include the effects of appurtenances (belt cover). Power rating kW does not include transmission losses.
 - The A-weighted sound ratings shown have been calculated per AMCA International Standard 301. Values shown are for inlet Lw A sound power levels for installation type D - Ducted inlet, Ducted outlet. Ratings include the effects of duct end correction.



MXC 1600

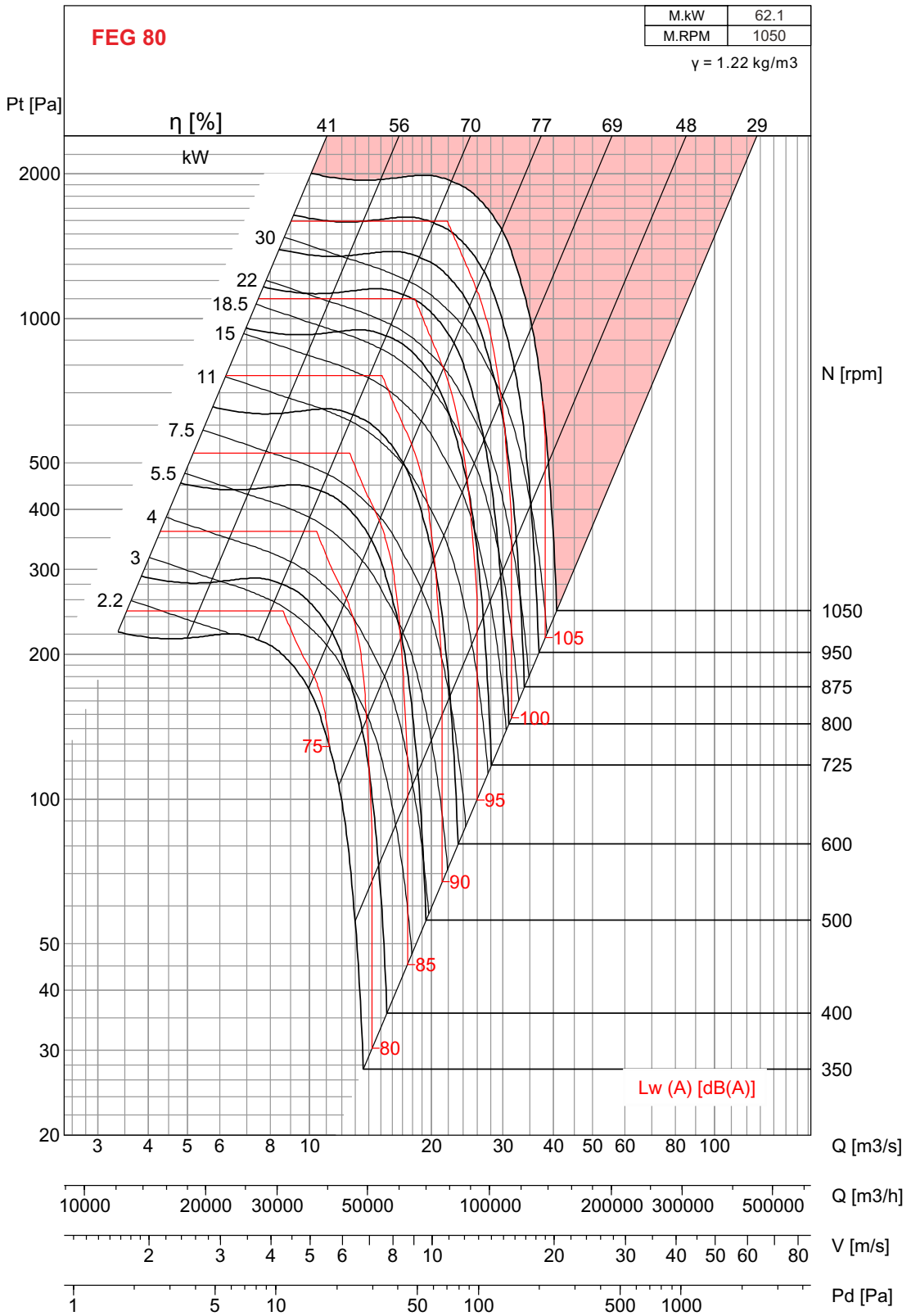

- Performance certified is for Installation type D - Ducted inlet, Ducted outlet. Performance ratings do not include the effects of appurtenances (belt cover). Power rating kW does not include transmission losses.
- The A-weighted sound ratings shown have been calculated per AMCA International Standard 301. Values shown are for inlet Lw i A sound power levels for installation type D - Ducted inlet, Ducted outlet. Ratings include the effects of duct end correction.



MXC 1800

FEG 80

M.kW	82.9
M.RPM	950

$\gamma = 1.22 \text{ kg/m}^3$

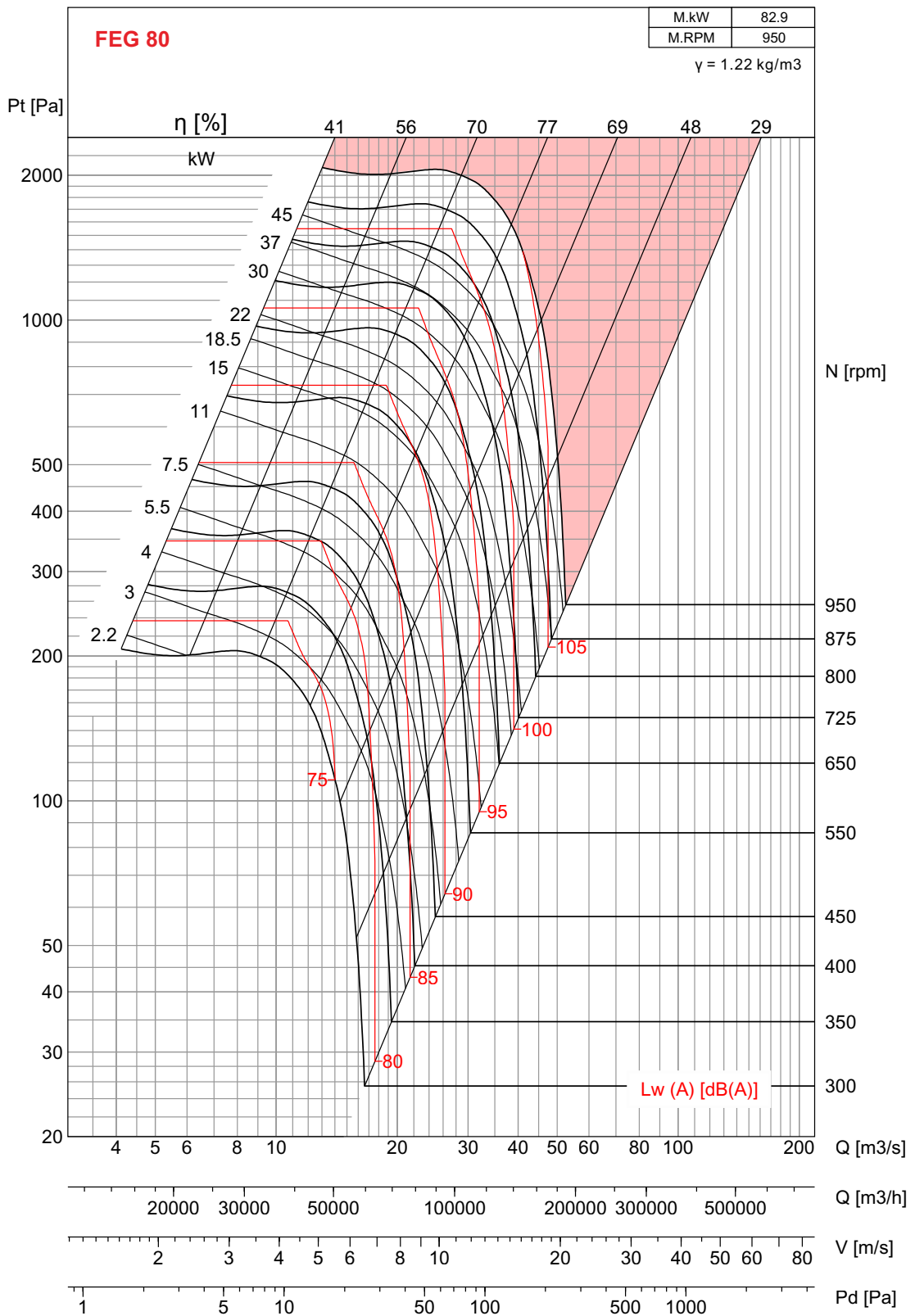

- Performance certified is for Installation type D – Ducted inlet, Ducted outlet. Performance ratings do not include the effects of appurtenances (belt cover). Power rating kW does not include transmission losses.
 - The A-weighted sound ratings shown have been calculated per AMCA International Standard 301. Values shown are for inlet Lw(A) sound power levels for installation type D – Ducted inlet, Ducted outlet. Ratings include the effects of duct end correction.



MXC 2000

FEG 80

M.kW	100.6
M.RPM	850

$\gamma = 1.22 \text{ kg/m}^3$

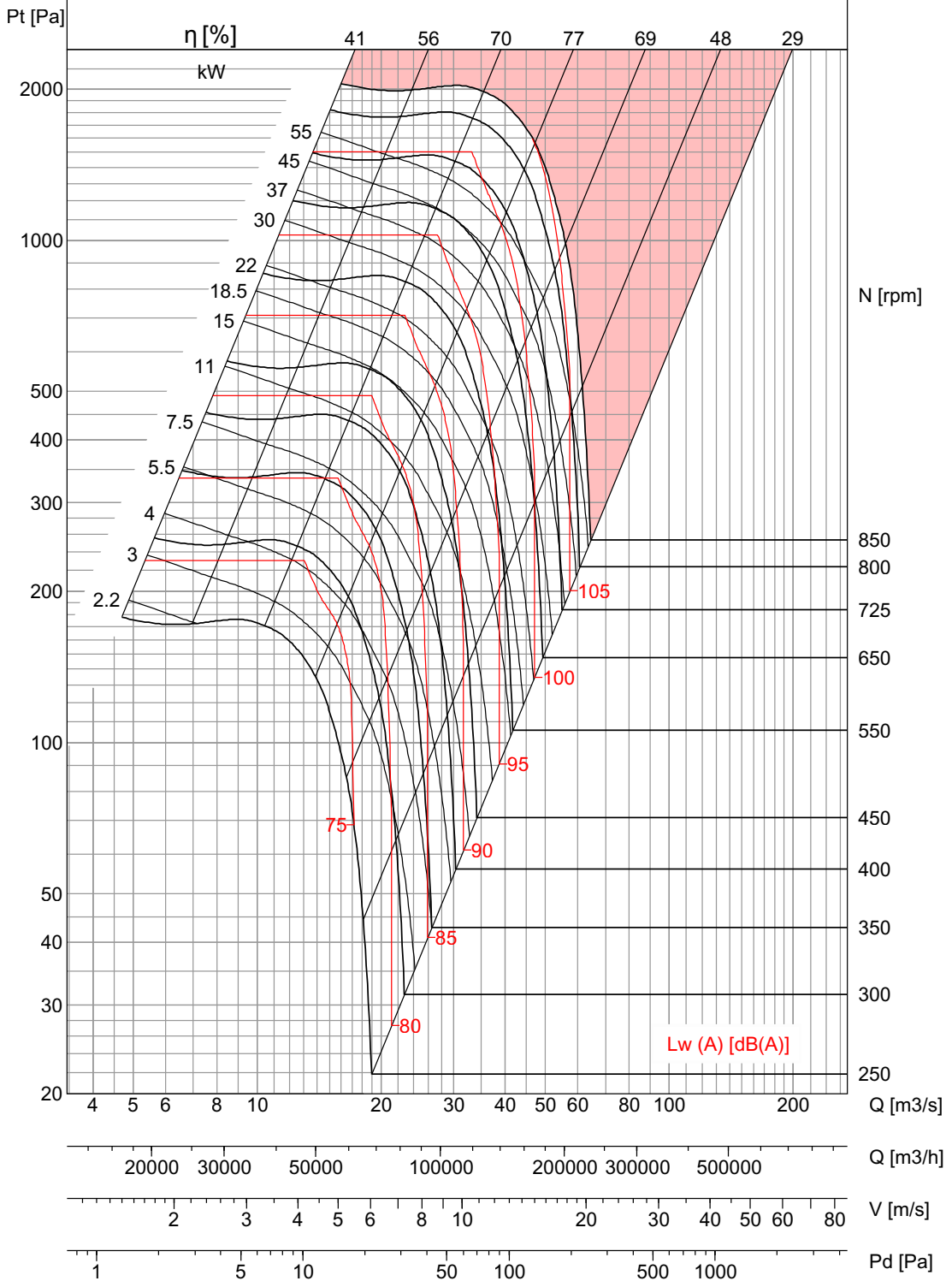

- Performance certified is for Installation type D – Ducted inlet, Ducted outlet. Performance ratings do not include the effects of appurtenances (belt cover). Power rating kW does not include transmission losses.
 - The A-weighted sound ratings shown have been calculated per AMCA International Standard 301. Values shown are for inlet Lw(A) sound power levels for installation type D – Ducted inlet, Ducted outlet. Ratings include the effects of duct end correction.

Fan Energy Inex

Example of FEI Selection

Air Volume Q = 10.31 m³/s
 Fan Speed N = 1450 rpm
 FEI = 1.33

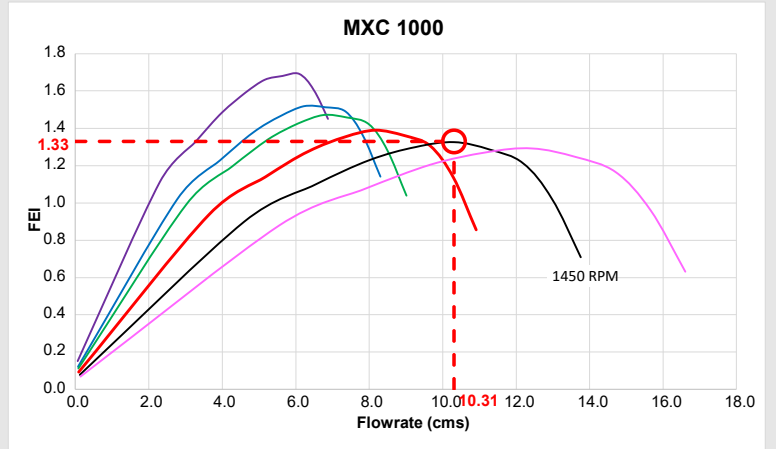

Direct drive models

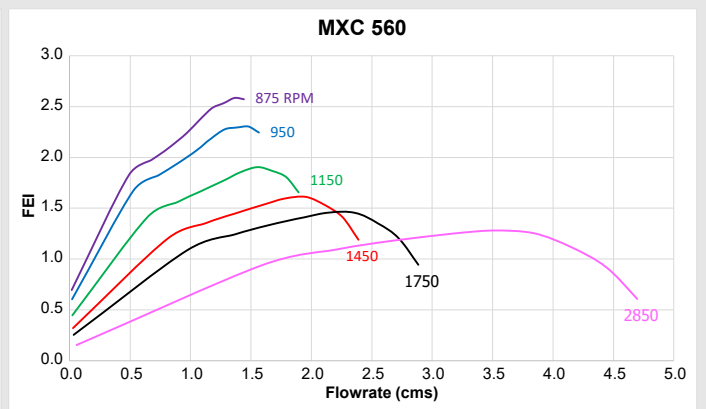
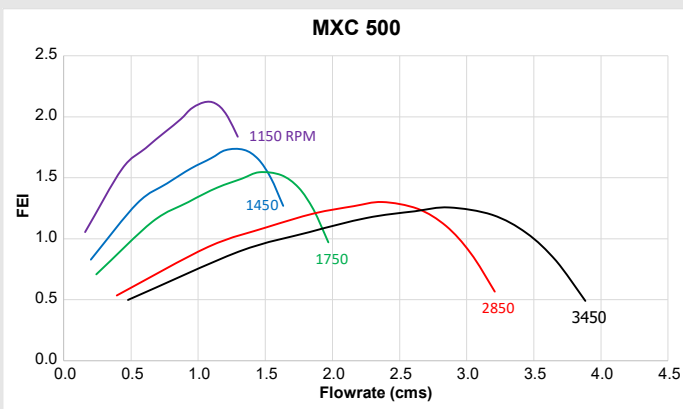
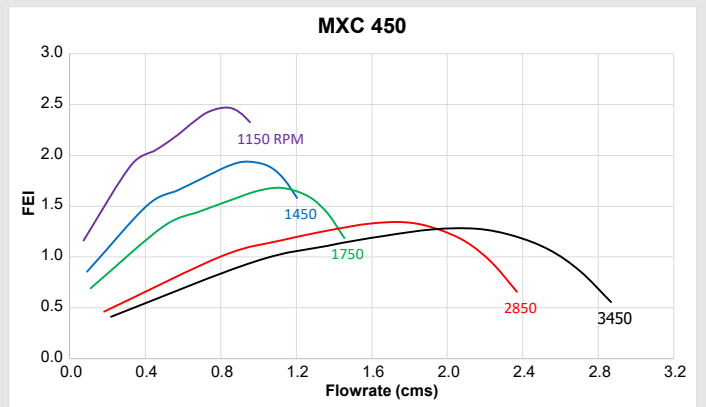
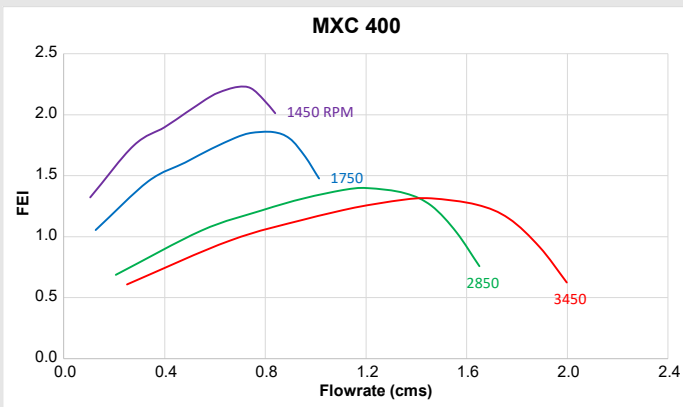
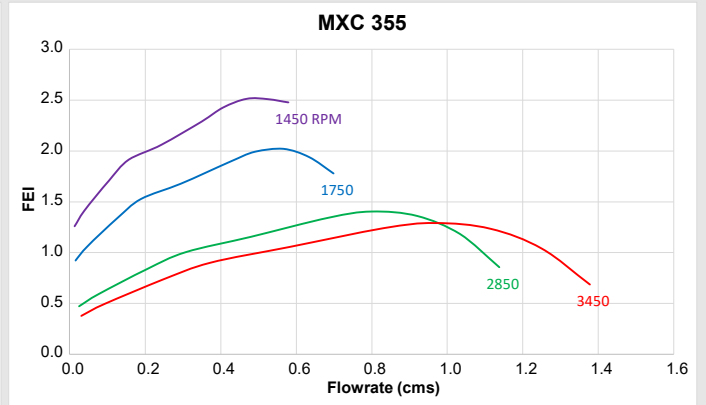
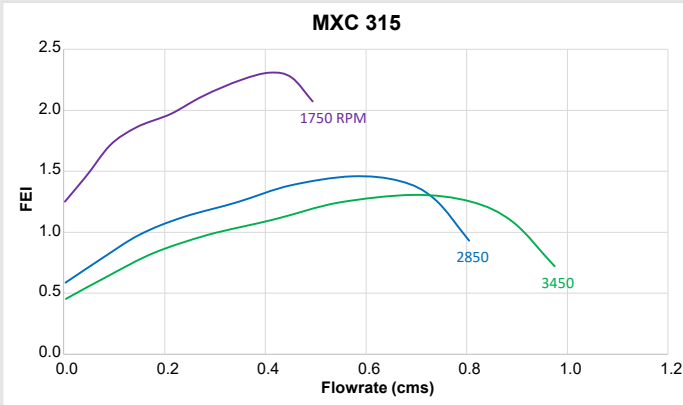

Performance certified is for installation type D - Ducted inlet, Ducted outlet. Power rating (kW) does not include transmission losses. Performance ratings do not include the effects of appurtenances (accessories). FEI_T values are calculated in accordance with ANSI/AMCA Standard 208 and are based on default motor efficiencies (Direct Driven type). FEI_T values for fans with specific motors will vary slightly from those shown. Fan speed shown in RPM.

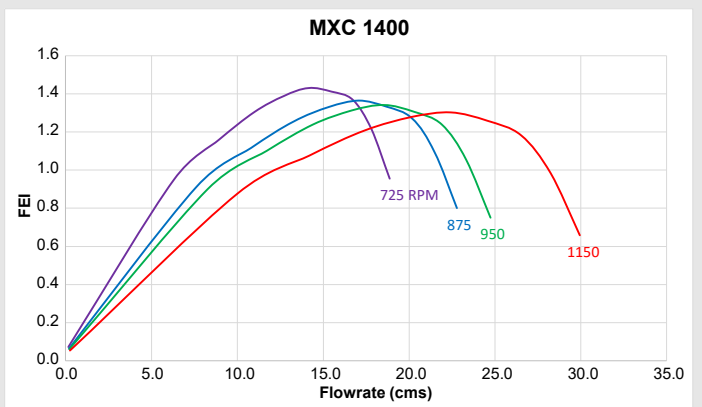
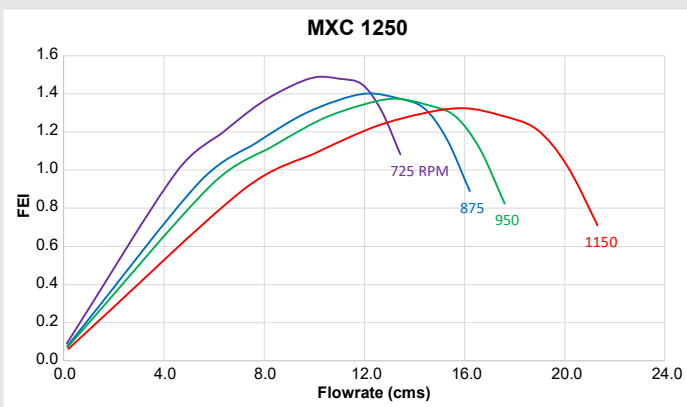
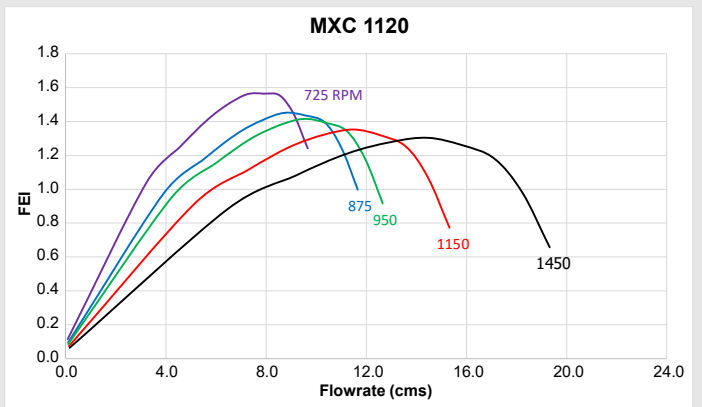
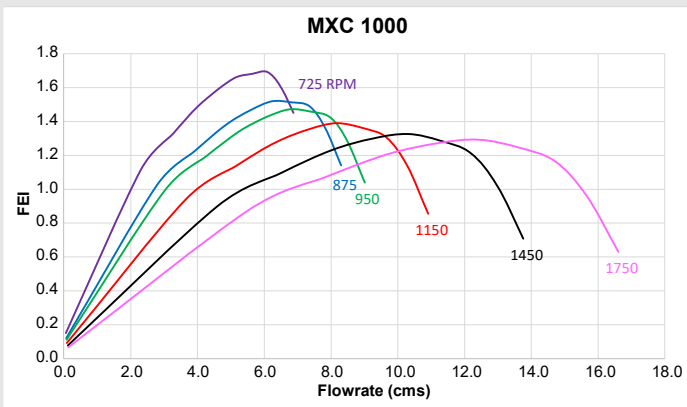
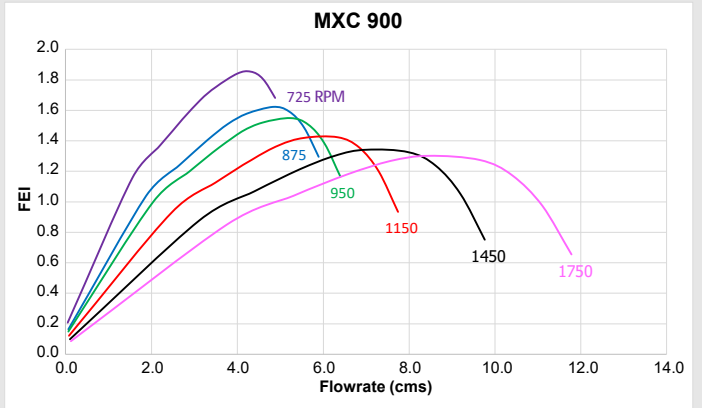
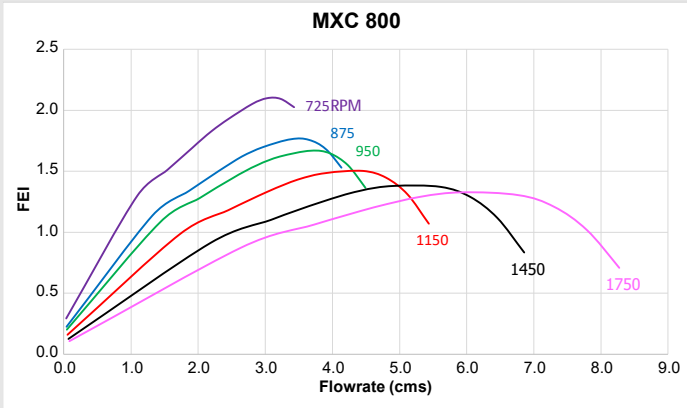
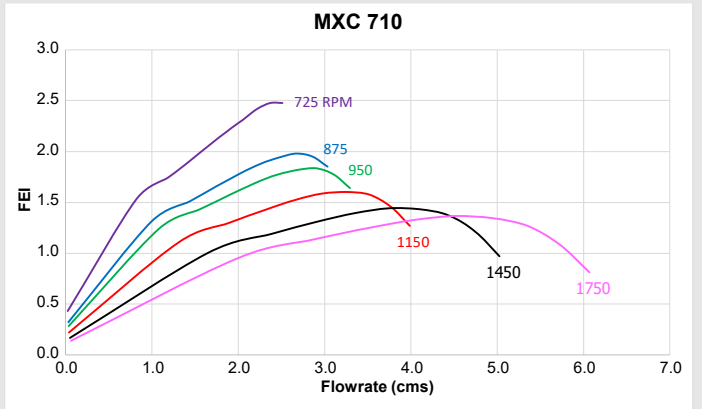
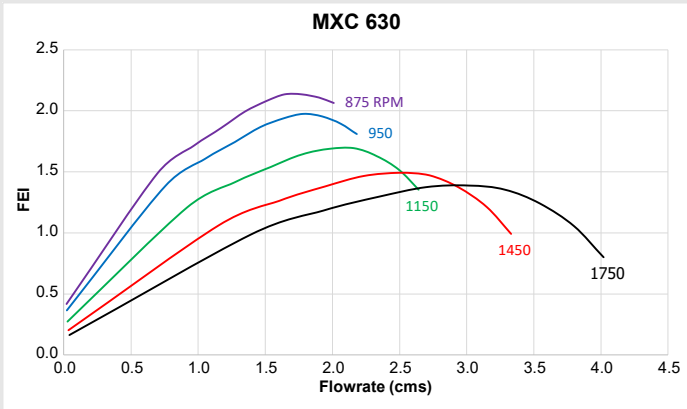

Performance certified is for installation type D - Ducted inlet, Ducted outlet. Power rating (kW) does not include transmission losses. Performance ratings do not include the effects of appurtenances (accessories). FEI_T values are calculated in accordance with ANSI/AMCA Standard 208 and are based on default motor efficiencies (Direct Driven type). FEI_T values for fans with specific motors will vary slightly from those shown. Fan speed shown in RPM.

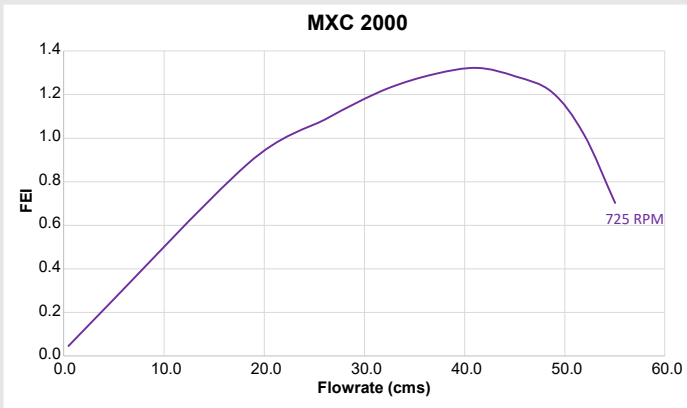
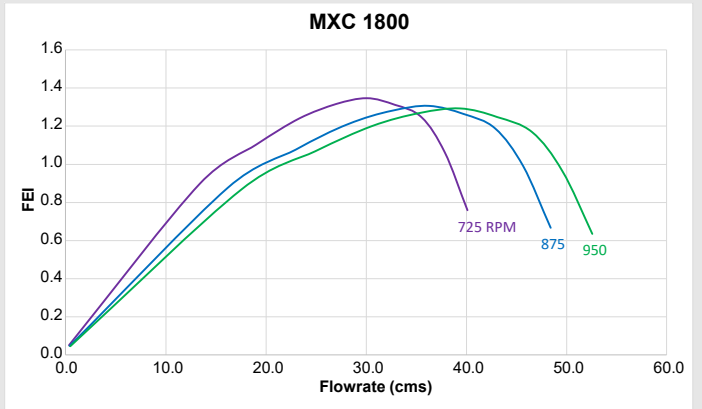
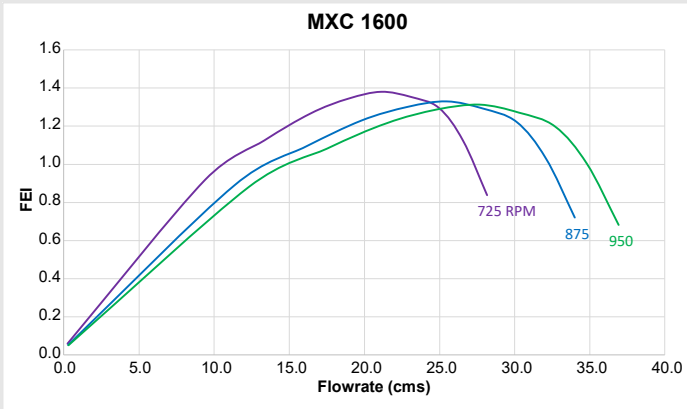

Performance certified is for installation type D - Ducted inlet, Ducted outlet. Power rating (kW) does not include transmission losses. Performance ratings do not include the effects of appurtenances (accessories). FEI_T values are calculated in accordance with ANSI/AMCA Standard 208 and are based on default motor efficiencies (Direct Driven type). FEI_T values for fans with specific motors will vary slightly from those shown. Fan speed shown in RPM.

Belt drive models

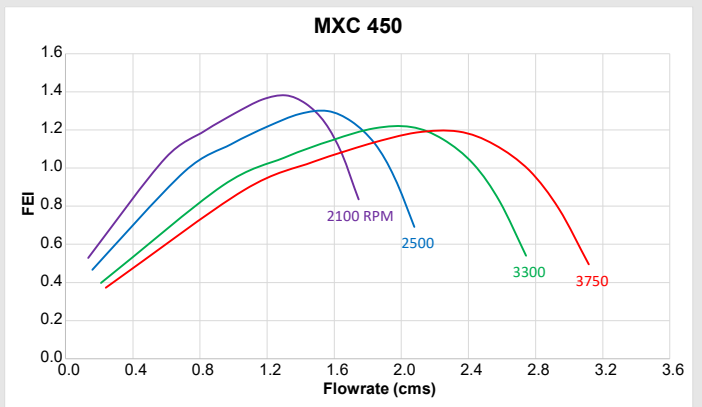
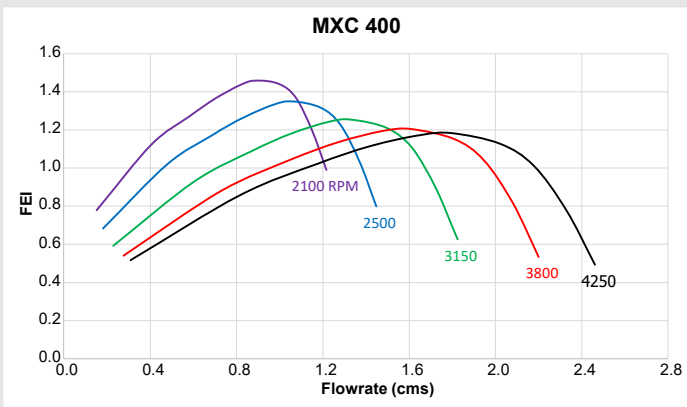
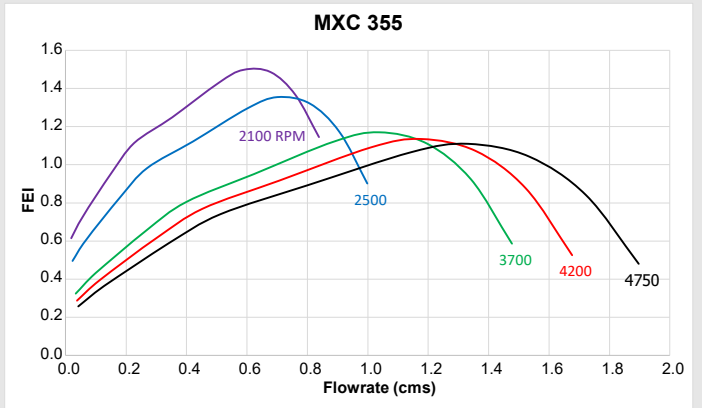
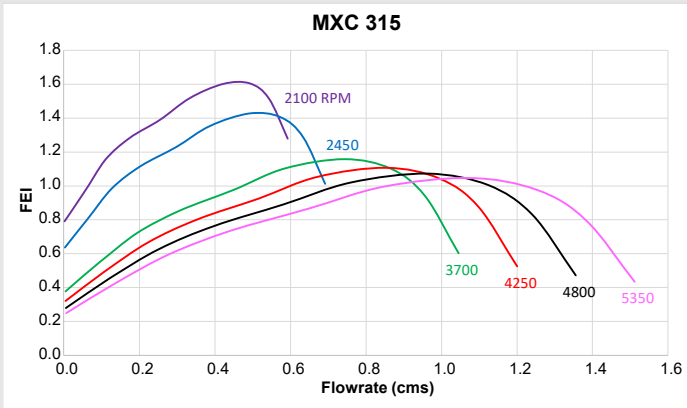

Performance certified is for installation type D - Ducted inlet, Ducted outlet. Power rating (kW) does not include transmission losses. Performance ratings do not include the effects of appurtenances (belt cover). FEI_T values are calculated in accordance with ANSI/AMCA Standard 208 and are based on default motor efficiencies (Belt Driven type). FEI_T values for fans with specific motors will vary slightly from those shown. Fan speed shown in RPM.

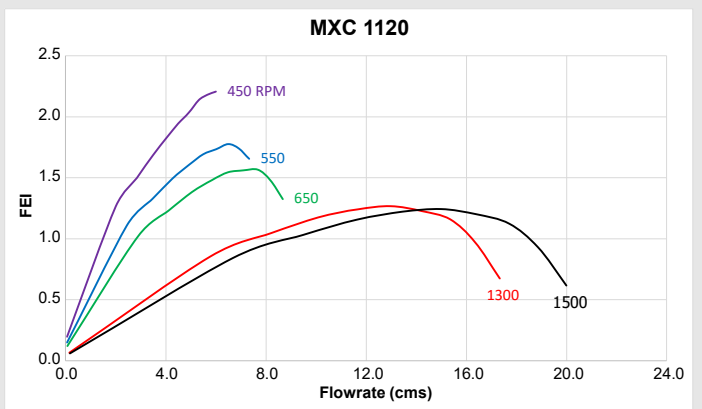
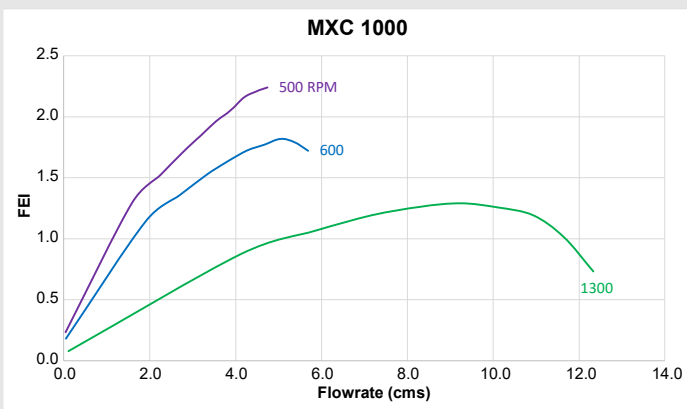
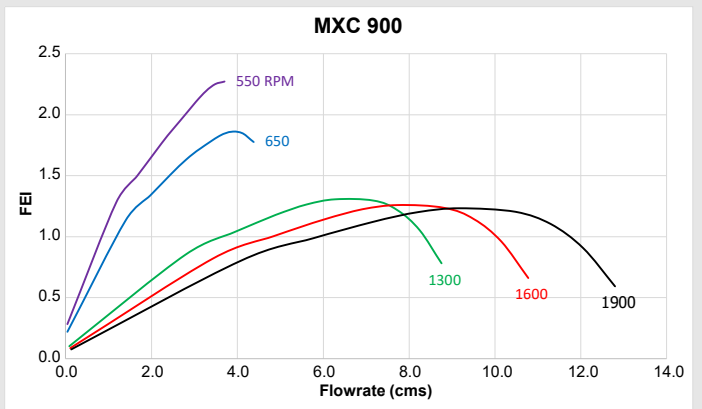
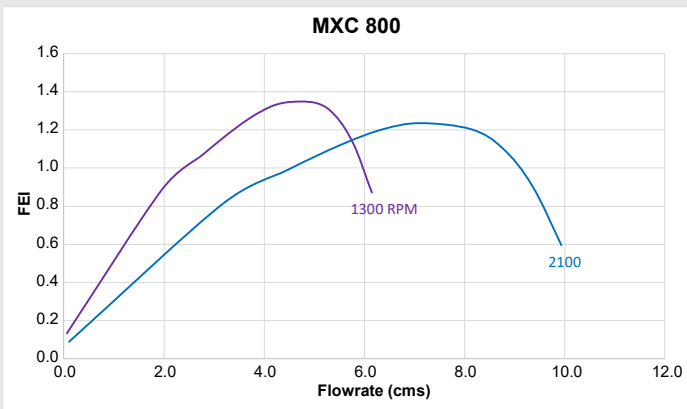
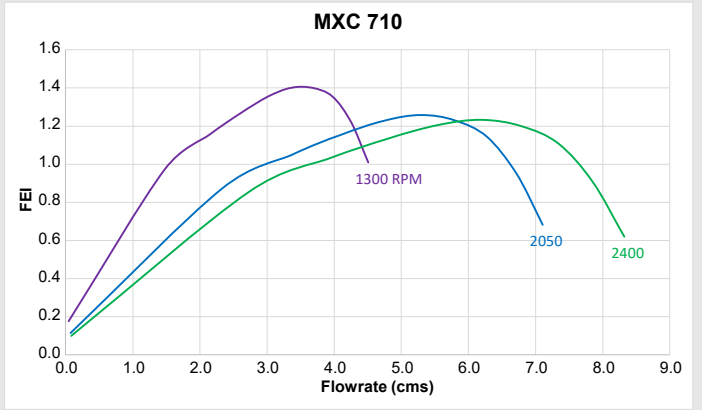
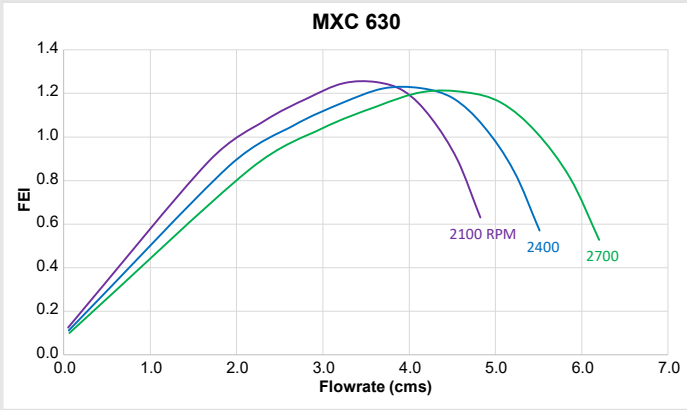
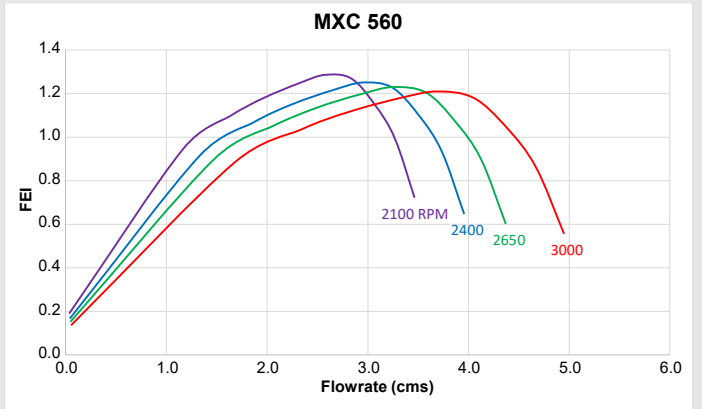
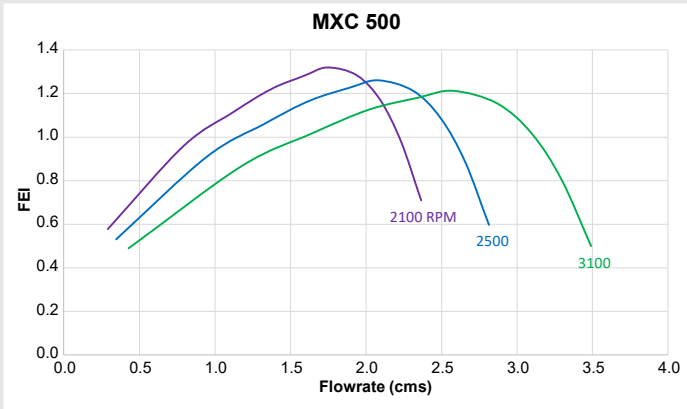

Performance certified is for installation type D - Ducted inlet, Ducted outlet. Power rating (kW) does not include transmission losses. Performance ratings do not include the effects of appurtenances (belt cover). FEI_T values are calculated in accordance with ANSI/AMCA Standard 208 and are based on default motor efficiencies (Belt Driven type). FEI_T values for fans with specific motors will vary slightly from those shown. Fan speed shown in RPM.

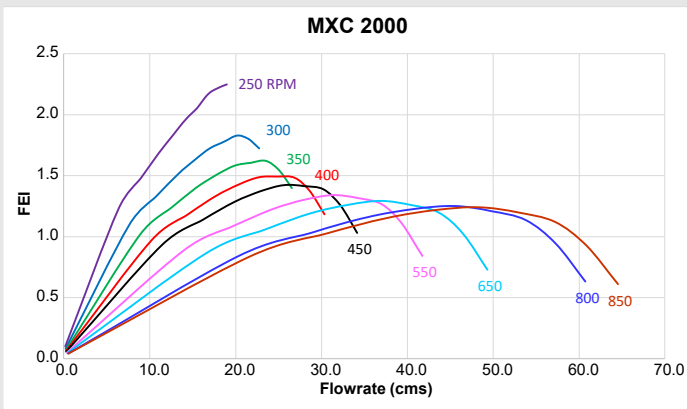
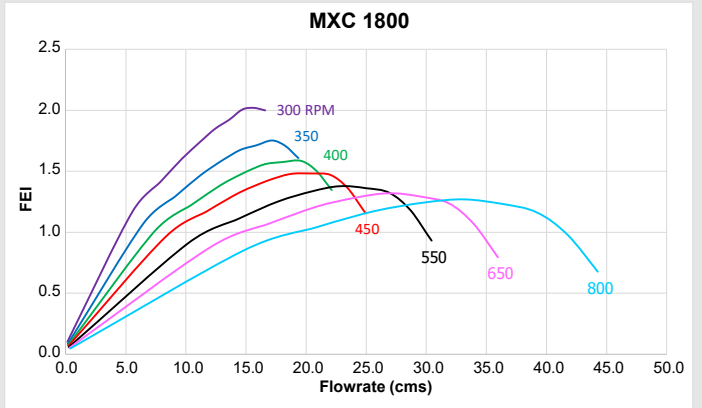
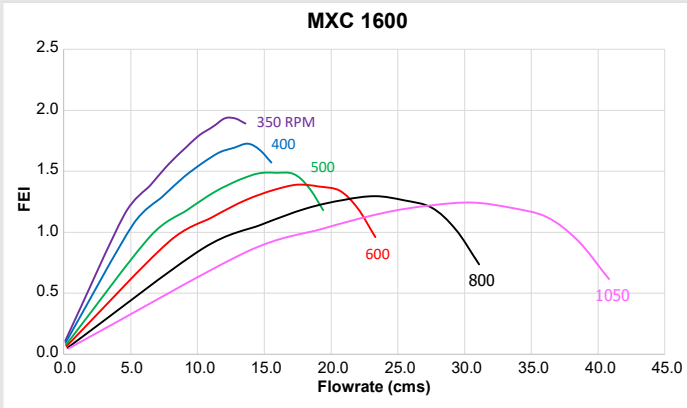
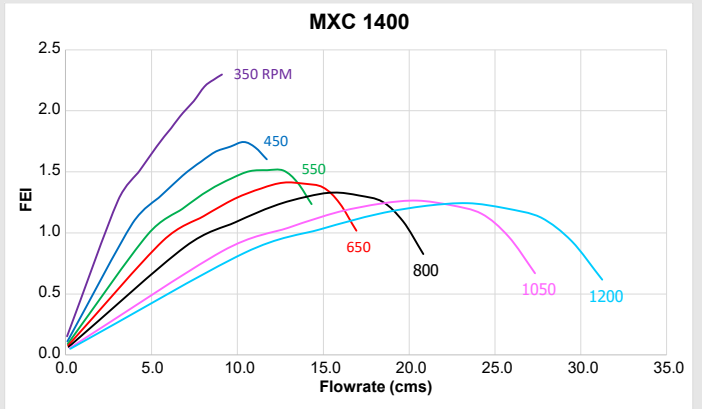
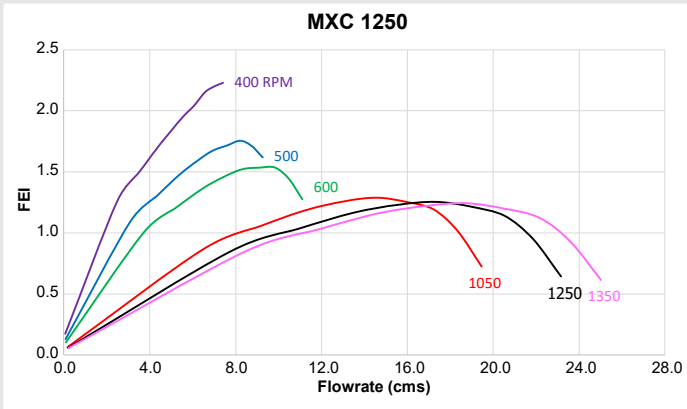

Performance certified is for installation type D - Ducted inlet, Ducted outlet. Power rating (kW) does not include transmission losses. Performance ratings do not include the effects of appurtenances (belt cover). FEI_T values are calculated in accordance with ANSI/AMCA Standard 208 and are based on default motor efficiencies (Belt Driven type). FEI_T values for fans with specific motors will vary slightly from those shown. Fan speed shown in RPM.

KRUGER GROUP (VENTILATION)

THAILAND (Regional HQ)

KRUGER VENTILATION INDUSTRIES ASIA CO. LTD.
30/159 Moo 1, Sinsakorn Industrial Estate,
Chetsadawithi Road, Khok Kham Mueng, Samuthsakorn 74000, Thailand
Tel: +662 1054298 Fax: +662 0248256-9
Website: www.krugerfan.com

CHINA (SHANGHAI)

SHANGHAI KRUGER VENTILATION CO.,LTD.
No.500 Yuanguo Road, Anting, Jiading District,
Shanghai 201814, P.R. China
Tel: +86 21-69573266 Fax: +86 21-69573296
Email: shkruger@krugerchina.com

CHINA (WUHAN)

WUHAN KRUGER VENTILATION CO. LTD.
No. 805, Huian Ave, Dongxihu District, Wuhan, Hubei, P.R. China 430040
Tel: +86 27- 83248840/83060522/83097505
Fax: +86 27- 83261886
Email: whkruger@krugerwh.com

HONG KONG

KRUGER VENTILATION (HONG KONG) LIMITED.
Flat C, 9/F, Yeung Yiu Chung (No.8) Industrial Building,
20 Wang Hoi Road, Kowloon Bay, Kowloon, Hong Kong
Tel: +852 22469182 Fax: +852 22469187
Email: info@kruger.com.hk

INDIA (NORTH)

KRUGER VENTILATION INDUSTRIES (NORTH INDIA) PVT LTD
Village Rohad, Tehsil Bahadurgarh, Jhajjar, Haryana-124507
Tel. +91-9958991652/9958991660/8586966303
Fax +91-1276-278096
tEmail: sales.kni@krugerindia.com , service@krugerindia.com

KOREA

NEOMATE CO. LTD.
2-1010, Ace High Tech City B/D, 775 Gyeongin-ro,
Yeongdeungpo-gu, Seoul, Korea. Postal Code 07299
Tel: +82-2-2679-2052 Fax: +82-2-2679-2174
Email: y7890@neomate.co.kr

MYANMAR

KRUGER VENTILATION (MYANMAR) CO. LTD.
Room No. F21, Thiri Yadanar Whole Sale Market, (Htawunbe)
Toe Chae Ward, North Okkalapa Township, Yangon.
Tel: +959 763141081/2/3
Email: htoon@krugermm.com

SINGAPORE

KRUGER ENGINEERING PTE. LTD.
No. 10 Buroh Street #06-06, West Connect Building,
Singapore 627564
Tel: +65 68631191 Fax: +65 68631151
Email: mktg@krugerasia.com

THAILAND

KRUGER VENTILATION IND. (THAILAND) CO. LTD.
30/105 Moo 1, Sinsakorn Industrial Estate,
Chetsadawithi Road, Khok Kham Mueng, Samuthsakorn 74000, Thailand
Tel: +662 1050399 Fax: +662 1050370-2
Email: mktg@kruger.co.th

AUSTRALIA

S&P KRUGER AUSTRALIA PTY. LTD.
2 Cunningham St, Moorebank N.S.W. 2170
Tel: +61 2-98227747
Fax: +61 2-98227757
Email: info@sandpkruger.com.au

CHINA (GUANGZHOU)

GUANGZHOU KRUGER VENTILATION CO. LTD.
No. 9 Huahui Road, Huashan, Huadu,
Guangzhou, P.R. China 510880
Tel: +86 20-66356635 Fax: +86 20-86786001/86786500
Email: gzkruuger@krugergz.com

CHINA (TIANJIN)

TIANJIN KRUGER VENTILATION CO. LTD.
Jingjin Science and Technology Park
Wuqing District, Tianjin, China
Tel: +86 22-22143480/3481 Fax: +86 22-22143482
Email: krugertj@krugertj.com

DUBAI

KRUGER VENTILATION INDUSTRIES, GULF BRANCH.
Jebel Ali Free Zone Area (JAFZA) P.O. Box No. 262949, Dubai, UAE
Tel: +971 4 8819188/8832017
Fax: +971 4 8832018
Email: johncs@krugerasia.com

INDIA

KRUGER VENTILATION INDUSTRIES (INDIA) PVT. LTD.
Kruger Centre, Mumbai-Nasik Highway,
Kalamgaon, Shahapur, Thane 421601, Maharashtra, India
Tel: +91 9960558899/9975577211
Email: sales@krugerindia.com

INDONESIA

P.T. KRUGER VENTILATION INDONESIA.
JL. Teuku Umar No.20,
Karawaci - Tangerang 15115, Indonesia
Tel: +62 21-5512288/5513557 Fax: +62 21-5513502
Email: mktg@krugerindo.co.id

MALAYSIA

KRUVENT INDUSTRIES (M) SDN. BHD.
Lot 850, Jalan Subang 7, Taman Perindustrian Subang,
47500, Subang Jaya, Selangor D.E.
Tel: +603 80743399 Fax: +603 80743388
Email: mktg@kruger.com.my

PHILIPPINES

KRUGER M & E INDUSTRIES CORPORATION
B3 Welborne Industrial Park
Bancal Carmona Cavite 4116, Philippines
Tel: +63-2-7 6223260 * +63-46 4129652
HP: +63 925 8018444
Email: mktg@krugerph.net

TAIPEI

KRUGER VENTILATION (TAIWAN) CO. LTD.
No. 157, Ping-an Rd, Hengfeng Village,
Dayuan Shiang Taoyuan County 337, Taiwan
Tel: +886 3-3859119 Fax: +886 3-3859118
Email: sales@krugertwn.com.tw

VIETNAM

KRUGER VENTILATION INDUSTRIES (VIETNAM) CO. LTD.
Lot A7. 2-4, C2 Road, Thanh Thanh Cong IZ,
Trang Bang Dist. Tay Ninh Province, Vietnam
Tel: +84-276 3585200/01/02 Fax: +84-276 3585199
Email: mktg@krugervn.com



KRUVENT INDUSTRIES (M) SDN. BHD.

Lot 850, Jalan Subang 7, Taman Perindustrian Subang, 47500,
Subang Jaya, Selangor D.E.

Tel: +603 80743399 Fax: +603 80743388

Website: www.krugerfan.com

CAT040.E0.KVM November 2023

A member of

