

AXIAL FAN SERIES

ADTA • ADTA-F

NICOTRA | Gebhardt



Nicotra Gebhardt (Guangzhou) Co. Ltd.

certifies that the ADTA and ADTA-F Series shown herein are licensed to bear the AMCA Seal.

The ratings shown are based on tests and procedures performed in accordance with AMCA Publication 211 and AMCA Publication 311 and comply with the requirements of the AMCA Certified Ratings Program.

fan|tastic solutions

AXIAL FAN ADTA/EN/60HZ/OCTOBER/2022

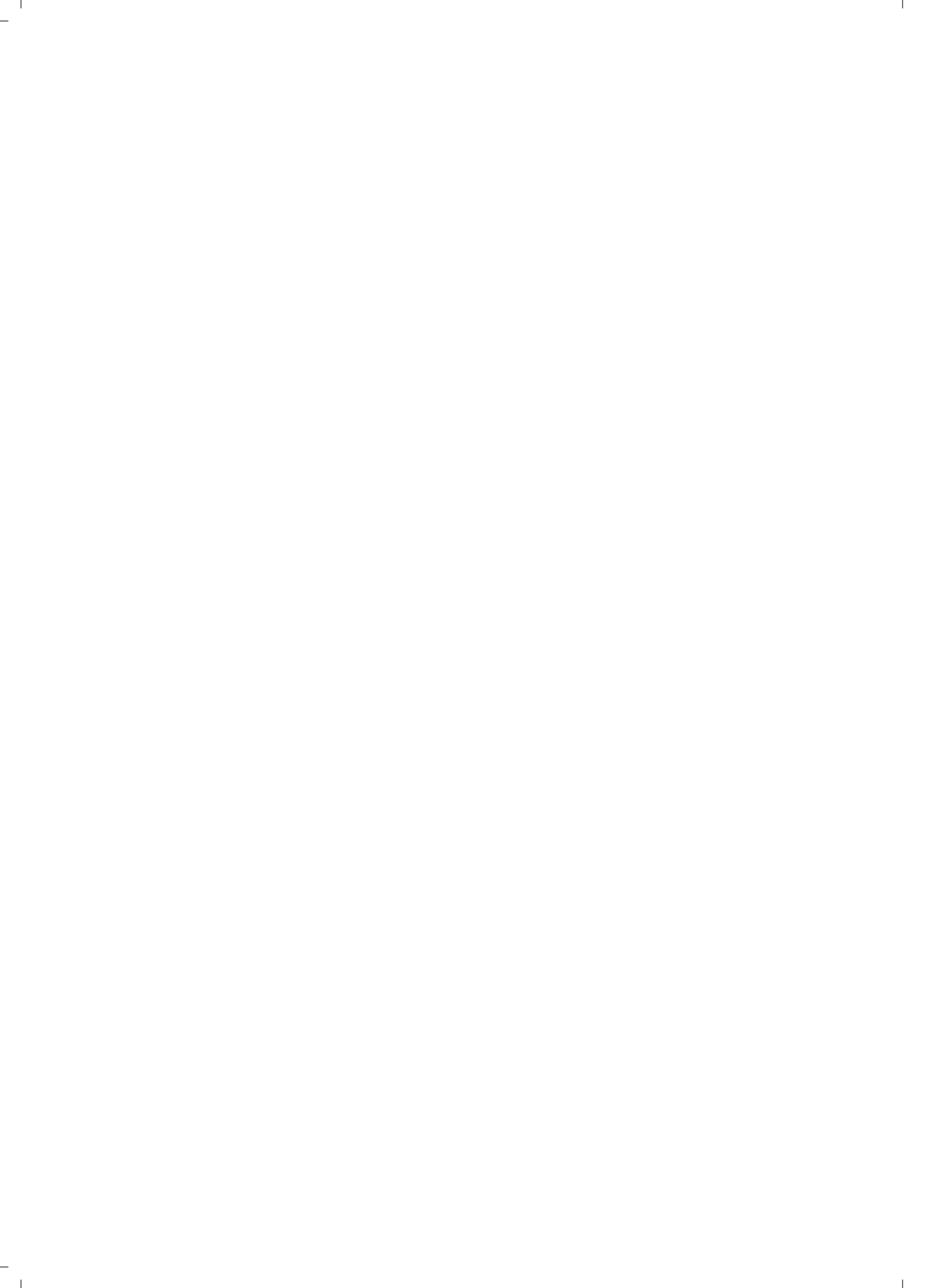

Introduction

The Nicotra Gebhardt axial fan provide wide range of air volume from 360 m³/hr to 216,000 m³/hr, at static pressure up to 1000 Pa of complete fan system with most diversified application. Remarkably high fan efficiencies are the direct result of rigorously developed aerodynamically profiled impeller blades and advanced manufacturing technique.

FEATURES

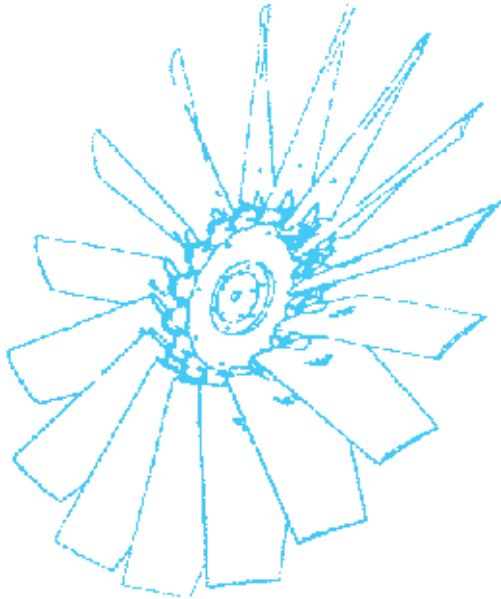

- High Efficiency
- Fully Adjustable Blade
- Versatile
- High Quality Material
- Interchangeable Components
- The Axial Impeller Is Balanced In Line ISO 1940, G2.5
- Robust Construction
- GRN and Pressure Die Cast Aluminium Material
- Anti-static GRN for Anti Spark Application
- Third Party Certification On BS EN 12101-3:2015 For Smoke Spill Application
- Series ADTA is AMCA Certified For Air and Sound Performance.
- AMCA Licensed for Air Performance, Sound and FEG

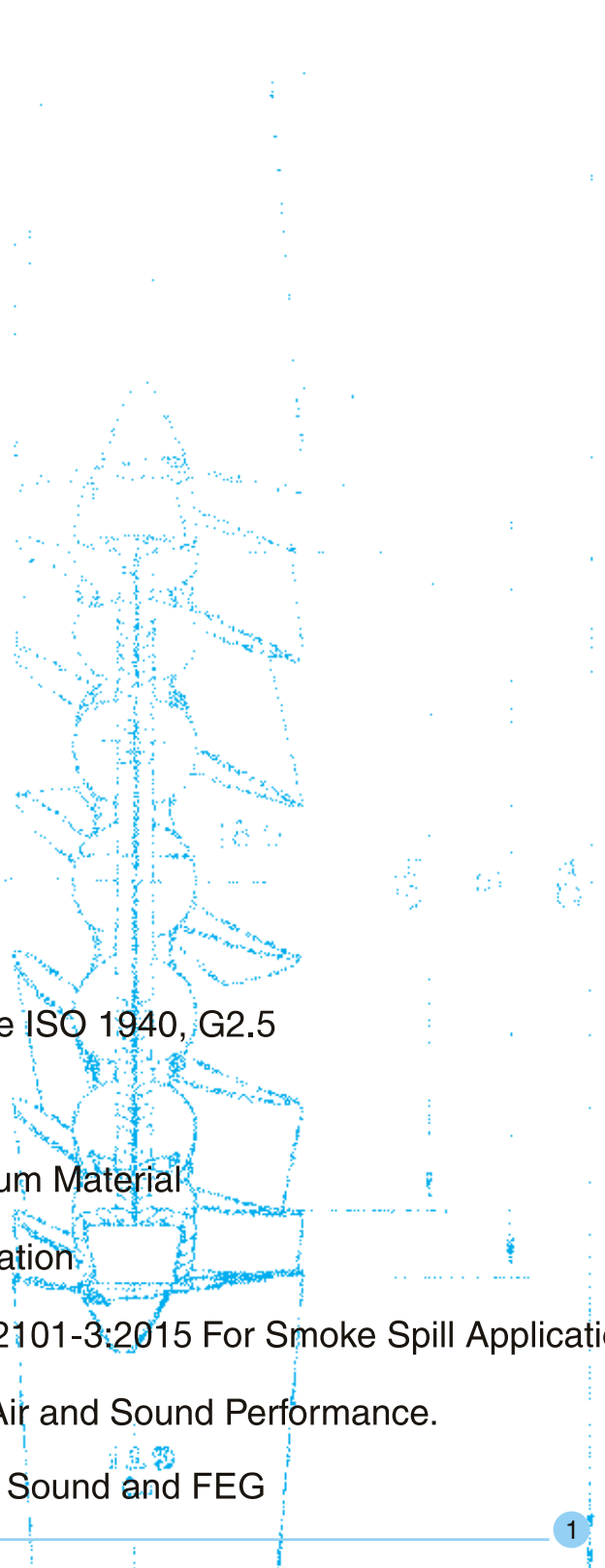

Balancing

All Nicotra Gebhardt axial impellers and fans are balanced to ISO Std No 1940, Edition using balancing grade of G2.5 (Displacement Amplitude = 2.5 mm/s) in our factory.

Hub System

Our range of axial fan is fully adjustable blades and there are basically 6 hubs systems as shown below:

Hub Size	Number of Blades
110	5 Blades
160	5 & 10 Blades
230	3, 6 & 12 Blades
250	3, 6 & 12 Blades
400	4, 8, 12 & 16 Blades
550	4, 7 & 11 Blades

Hub Combination for Axial Fan

The complete hub system for impeller 1400 and 1600 consists of side plate metal, center hub, aluminium blade, blade holder and taper lock bush.

Our 250 and 400 hub are designed to be mounted with taper-lock bush 2517 of 42mm, 48mm, 55mm and 60mm diameter as optional feature.

Blades Design / Types

Basically, we have the following design of impellers:

Design Type	Material	Hub System
B	ALU	110, 160, 230
T	ALU	250
C	ALU	400

Casing Surface Finishing

All standard axial fan tube casing's surface are applied with paint - RAL 7039 by powder coating method. Coating thickness is 60µm.

Thus, by this method, tube casing surface appeared to be wrinkle and provide better protection against chemical and wear.

Long case axial casings are rolled from 2.0 mm to 5.0 mm mild steel. The standard double flanged L bracket mounting is provided, foot mounted support can be provided as optional. Tube casing come with standard view port, and the access door can be requested as option.

Electric Motor

Nicotra Gebhardt use standard three phase motors TEFC, foot mounted insulation in accordance with IEC standard EN 60034, Enclosure IP55, insulation Class "F". Other medium temperatures, protection classes, two speed motor (poles switch) and etc as optional.

Computer selection

Our user-friendly fan selection software allows you to select the most suitable model to your needs. Performance data and fan curve will be generated by the state of art software.

ADTA Series

APPLICATION

Nicotra Gebhardt ADTA are particularly suitable for the extraction of stale air, for general ventilation, drying process and all those applications which require moving large volumes of air.

CONSTRUCTION

The housing is made of heavy-gauge mild steel casing, seamless double flanges at both end. Powder coated bake enamel finishing (60 micron) or galvanized steel. High efficiency impeller made of adjustable pitch aerofoil blade; ALU type or GRN type. Foot mounting & Hot dip galvanized casing is available as an option.



WORKING TEMPERATURE

-40°C to 150°C : GRN

-40°C to 200°C : ALU

MOTOR

Three-phase with type of "Totally Enclosed Fan Cooled" (TEFC), horizontal foot mounted Squirrel Cage Induction Motor, featured with class F insulation system with Class B temperature rise (80°C). Voltage supply includes 400V/50Hz, 400V/60Hz or 440V/60Hz. Motor Standards are comply with IEC 60034 or BS 4999. Other requirements upon demand basis.

Motor are wired to an external terminal box with cable and through PVC or steel flexible conduit.

DIRECTION OF THE AIR

The standard air flow from the impeller to the motor (B), on demand the fans can be supplied with the direction from the motor to the impeller (A).

Air Performance

Air performance ratings of the ADTA fans described by ADTA catalogue have been derived from performance tests made with installation type “A (Free inlet & Free outlet) & D (with ducted inlet and ducted outlet)”. These tests were carried out in accordance with AMCA standard 210-16 (Fig. 12, and Fig. 15). Ratings are referred to the standard air density.

Sound Power Level

Noise ratings are calculated starting from sound power level measurements made in accordance with the AMCA standard 300-14, (Fig. 2D and Fig. 3D). The test results keep into consideration the presence of the motor inside the fan.



Nicotra Gebhardt (Guangzhou) Co. Ltd.

certifies that the ADTA and ADTA-F Series shown herein are licensed to bear the AMCA Seal.

The ratings shown are based on tests and procedures performed in accordance with AMCA Publication 211 and AMCA Publication 311 and comply with the requirements of the AMCA Certified Ratings Program.

ADTA-F Series

APPLICATION

Nicotra Gebhardt ADTA-F smoke spill axial fans are particularly designed for the removal of hot toxic smoke so as to remove the smoke at the escape passage and assist firefighters by providing better visibility. It also provide ventilation to the area during normal situation.

CONSTRUCTION

The housing is made of heavy-gauge mild steel casing, seamless double flanges at both end. Powder coated bake enamel finishing or galvanized steel. High efficiency impeller made of adjustable pitch aerofoil blade pressure die cast Aluminium. Hot dip galvanized casing is available as option.



MOTOR

High temperature resistance motor compliance to BS 7346 : Part2 : 1990 and EN 12101-3 : 2006 directive. Three phase with type of “Totally Enclosed Air Over” (TEAO), horizontal foot mounted Squirrel Cage Induction Motor, featured with class H insulation system with Class B temperature rise (80°C). Voltage supply includes 400V/50Hz, 400V/60Hz or 440V/60Hz. Motor Standards are comply with IEC 60034 or BS 4999. Other requirements upon demand basis.

Motor are wired to an external terminal box with cable and through flexible conduit.

TESTING

ADTA-F axial fans have been tested in accordance to BS EN 12101-3:2015
This series have been tested under below classification:

Temperature (deg.C)	Period (minutes)	Test Body
250	120	TUV SUD
316	240	TUV SUD
400	120	SGS

DIRECTION OF THE AIR

The standard air flow from the impeller to the motor (B), on demand the fans can be supplied with the direction from the motor to the impeller (A)

ADTA, ADTA-F General Dimension

ADTA, ADTA-F with Hanger

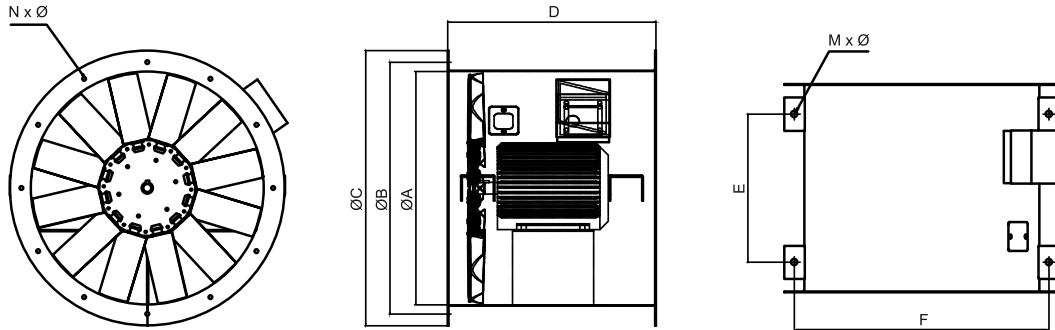

ADTA, ADTA-F with Mounting Feet (optional)

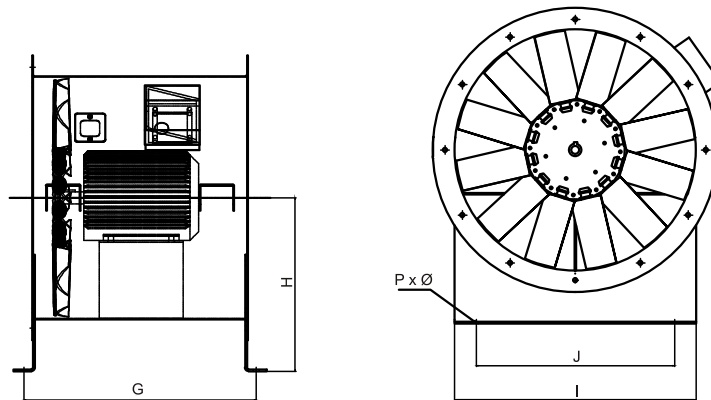

MODEL	ADTA/ADTA-F General Dimensions					ADTA/ADTA-F - Hanger			ADTA/ADTA-F - Mounting Feet (Optional)					Mtr Frame Size
	ØA	ØB (PCD)	ØC	D	N x Ø	E	F	M x Ø	G	H	I	J	P x Ø	
315	315	355	395	355	8 X 10	211	365	4 X 16	395	277.5	265	315	2 x 10	90
400	400	440	480	355	12 X 10	211	450	4 X 16	395	320	350	400	2 x 10	90
400	400	440	480	435	12 X 10	291	450	4 X 16	475	320	350	400	2 x 10	112
500	500	540	580	500	12 X 10	356	550	4 X 16	538	370	450	500	2 x 14	132
560	560	605	660	500	12 X 10	356	611	4 X 16	538	402.5	460	560	2 x 14	132
630	630	675	730	500	12 X 10	326	691	4 X 20	538	437.5	530	630	2 x 14	112
630	630	675	730	700	12 X 10	526	691	4 X 20	738	437.5	530	630	2 x 14	160
710	710	755	810	500	18 X 12	324	774	4 X 20	536	477.5	610	710	2 x 16	112
710	710	755	810	710	18 X 12	534	774	4 X 20	746	477.5	610	710	2 x 16	160
800	800	845	900	560	18 X 12	384	864	4 X 20	596	522.5	700	800	2 x 16	132
800	800	845	900	760	18 X 12	584	864	4 X 20	796	522.5	700	800	2 x 16	180
900	900	945	1000	630	18 X 12	454	964	4 X 20	666	592.5	800	900	2 x 16	132
900	900	945	1000	820	18 X 12	644	964	4 X 20	856	592.5	800	900	2 x 16	200
1000	1000	1045	1100	630	24 X 12	454	1065	4 X 20	666	672.5	900	1000	2 x 16	160
1000	1000	1045	1100	800	24 X 12	624	1065	4 X 20	836	672.5	900	1000	2 x 16	200
1120	1120	1185	1250	900	24 X 12	724	1185	4 X 20	936	742.5	1020	1120	2 x 16	225
1120	1120	1185	1250	1150	24 X 12	974	1185	4 X 20	1186	742.5	1020	1120	2 x 16	280
1250	1250	1315	1380	1000	24 X 12	794	1324	4 X 25	1084	807.5	1050	1250	3 x 20	250
1250	1250	1315	1380	1150	24 X 12	944	1324	4 X 25	1234	807.5	1050	1250	3 x 20	280
1400	1400	1465	1530	1120	32 X 14	912	1476	4 X 25	1202	882.5	1200	1400	3 x 20	280
1600	1600	1663	1730	1250	32 X 14	1042	1676	4 X 25	1332	981.5	1400	1600	3 x 20	315

Due to a policy of continuous development and improvement the right is reserved to supply product which may differ from those illustrated and described in this publications.

Certified dimensions will be supplied on receipt of order

ADTA, ADTA-F Exploded View

Part List, Specification, Arrangement

Part Description	Specification
1 Tube Casing	Painted (RAL 7039), Hot Dipped, Stainless Steel, etc
2 Terminal Box	PVC, Cast Iron, etc
3 Viewport Cover	Depend on t/casing material
4 Mounting Feet (Optional)	Depend on t/casing material
5 Counter Flange (Optional)	Depend on t/casing material
6 Electrical Motor	Specification as per requested
7 Impeller	ALU, GRN, GRN-antistatic
8 Fan Guard	Painted or Hot Dipped

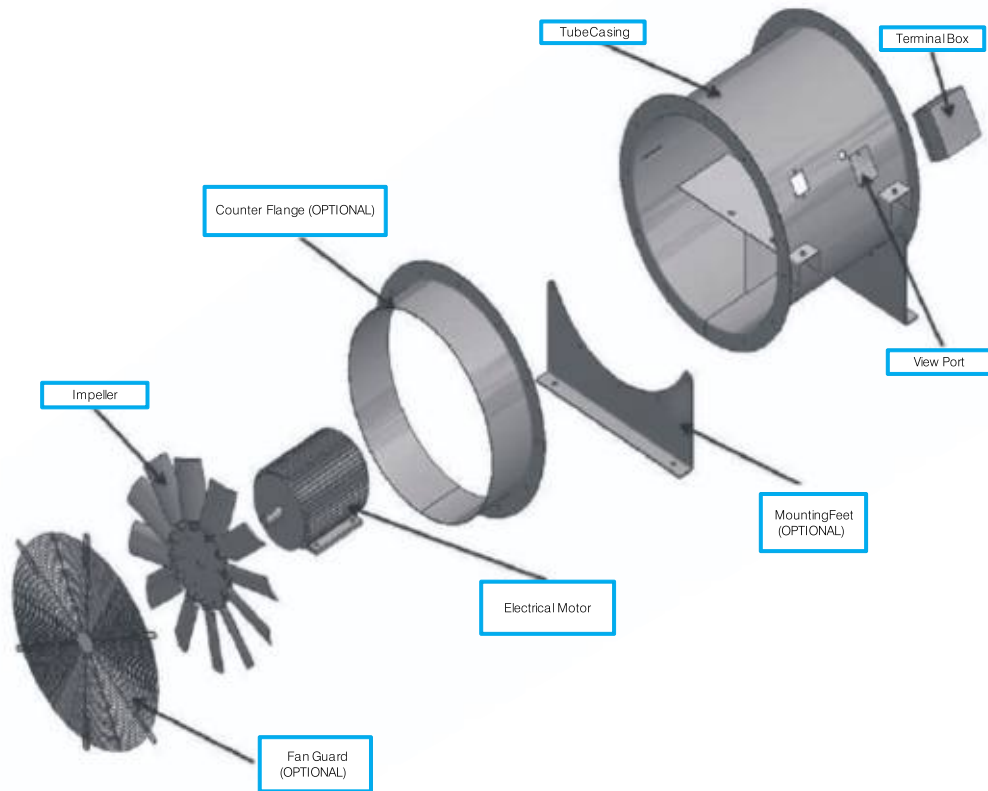

AXIAL COUNTER FLANGE (OPTIONAL)

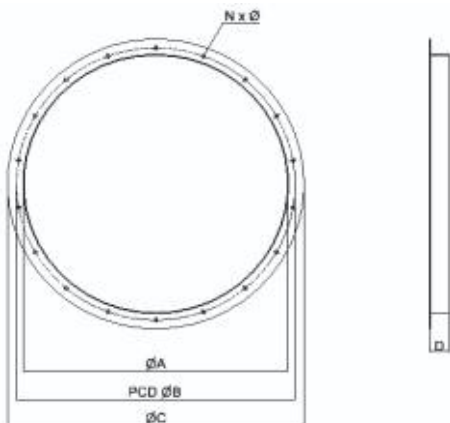

MODEL	$\varnothing A$	$\varnothing B$ (PCD)	$\varnothing C$	D	N x \varnothing
315	315	355	395	40	8 X 10
400	400	440	480	40	12 X 10
500	500	540	580	40	12 X 10
560	560	605	660	40	12 X 10
630	630	675	730	40	12 X 10
710	710	755	810	40	18 X 12
800	800	845	900	40	18 X 12
900	900	945	1000	60	18 X 12
1000	1000	1045	1100	60	24 X 12
1120	1120	1185	1250	60	24 X 12
1250	1250	1315	1380	60	24 X 12
1400	1400	1465	1530	60	32 X 14
1600	1600	1663	1730	60	32 X 14

Axial Fan Accessories

Vanes

For Vane Axial fan requirements, we supply guide Vanes along with Axial Fans. The Vanes are made of mild steel sheet duly powder coated. Powder coating thickness is 60 µm"

Sound Attenuators

We offer Circular Dissipative Silencers of different length, both at the inlet and exit of the Axial Fans, to reduce the airborne noise. The end caps have matching holes to exactly match the flange of the Fan.

Bird Screen

We also offer matching Bird screen along with the Axial Fans. The mesh wire is made of mild steel, with necessary crossing support.

Gravity Louver

Gravity louver can be offered at Axial Fan outlet with a matching flange. The flange & louvers are made of Steel Sheets.

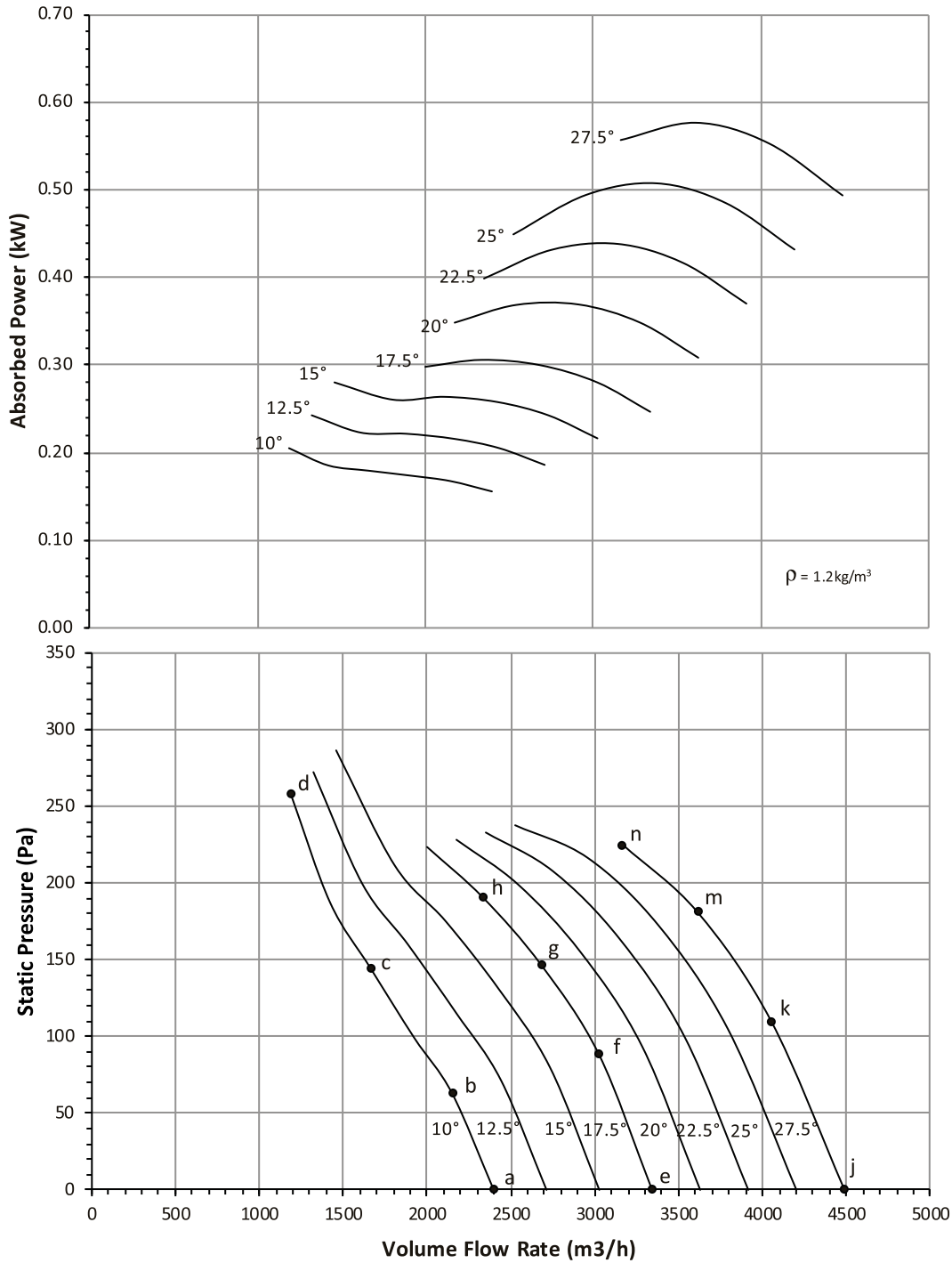

Ref	Full Octave Band Center Frequency								L _w A dB(A)
	63	125	250	500	1K	2K	4K	8K	
a	102	90	83	81	81	80	77	74	87
b	102	90	82	80	82	81	77	73	87
c	102	90	86	91	89	85	78	73	93
d	103	94	92	86	83	79	75	71	89
e	97	88	84	78	80	79	78	74	86
f	95	89	82	78	80	78	77	74	85
g	93	88	84	84	85	82	79	75	89
h	93	90	90	91	90	86	80	75	94
j	99	89	83	80	82	79	77	75	87
k	100	93	84	79	82	79	77	75	87
m	100	93	86	81	83	81	78	77	88
n	100	93	89	85	85	82	78	77	90



Performance certified is for Installation type D: Ducted Inlet- Ducted Outlet. Performance ratings do not include the effects of appurtenances (accessories) Power rating kW is fan input power. The Sound Power Level ratings shown are in decibels, referred to 10⁻¹² watts, calculated per AMCA International Standard 301. Values shown are for inlet L_w and L_wA sound power levels for Installation type D: Ducted Inlet-Ducted Outlet. Ratings include the effects of duct end correction. The A-weighted sound ratings shown have been calculated per AMCA International Standard 301.

Performance Curve
FEG 67

ADTA 400-160-10
ADTA-F 400-160-10

60Hz 3456 rpm

Outlet Area: 0.129 m²

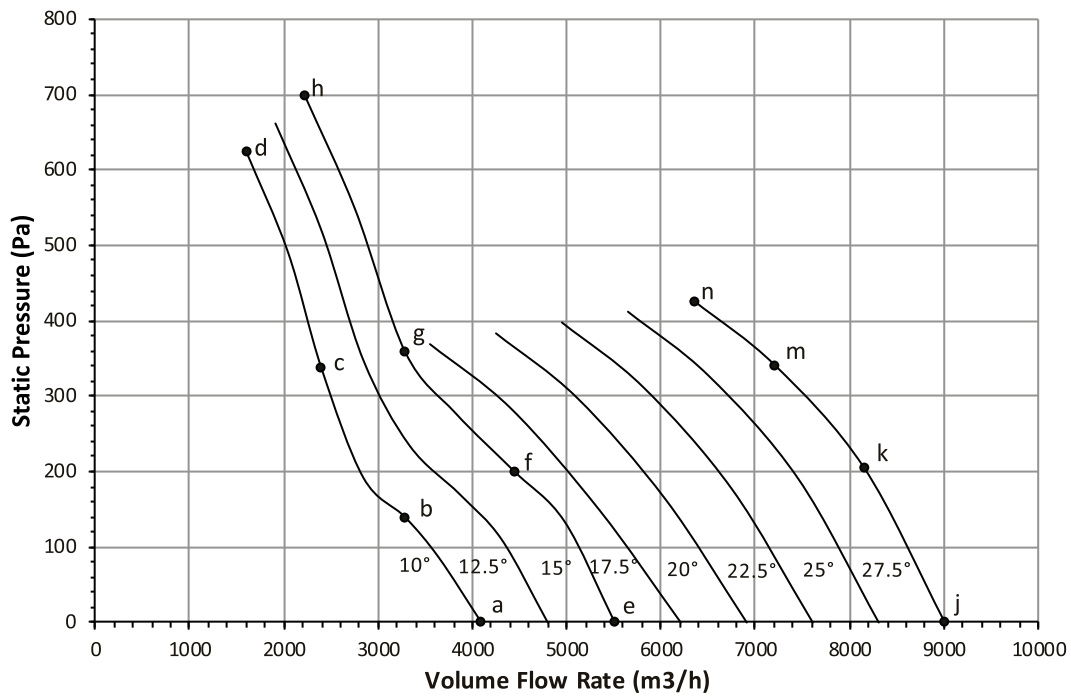
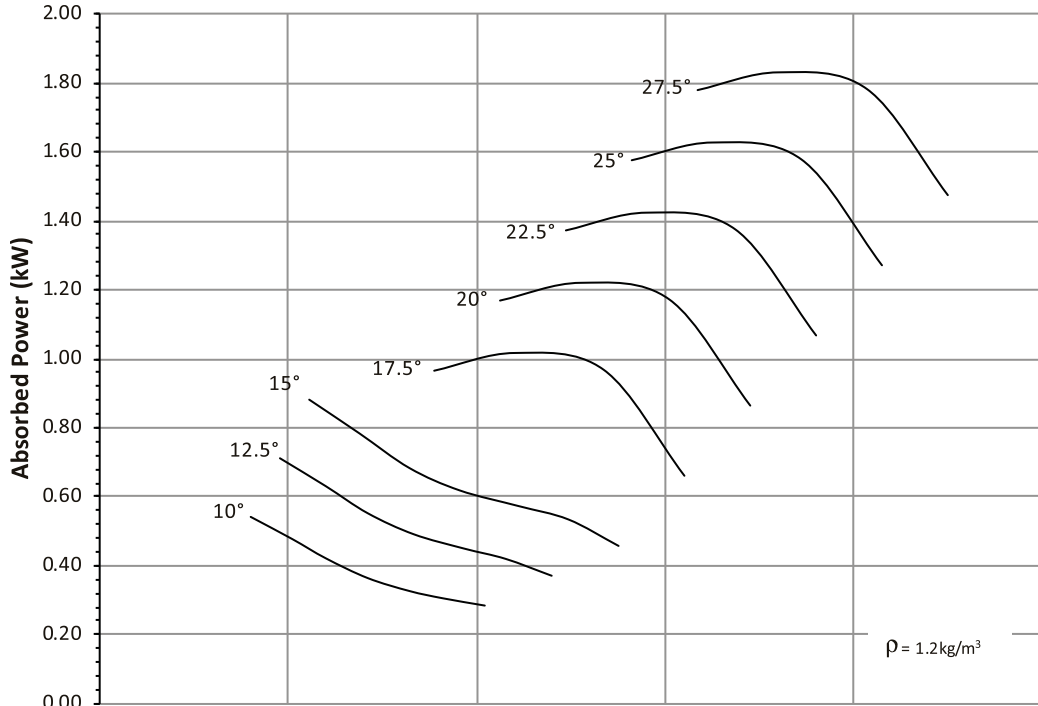

Ref	Full Octave Band Center Frequency								L _{WA} dB(A)
	63	125	250	500	1K	2K	4K	8K	
a	97	97	95	98	94	91	87	82	99
b	98	98	97	103	97	93	87	81	103
c	100	100	99	98	92	88	84	79	99
d	101	101	98	97	91	88	84	79	98
e	97	97	95	100	93	89	87	83	100
f	98	98	98	103	97	93	88	82	103
g	102	102	104	104	96	91	86	79	104
h	100	100	98	95	90	86	83	78	96
j	99	99	93	94	91	90	89	85	97
k	99	99	94	94	91	89	88	85	99
m	99	99	98	97	93	91	89	85	99
n	101	101	106	103	97	94	91	85	104



Performance certified is for Installation type D: Ducted Inlet- Ducted Outlet. Performance ratings do not include the effects of appurtenances (accessories) Power rating kW is fan input power. The Sound Power Level ratings shown are in decibels, referred to 10⁻¹² watts, calculated per AMCA International Standard 301. Values shown are for inlet L_{WA} and L_{WA} sound power levels for Installation type D: Ducted Inlet-Ducted Outlet. Ratings include the effects of duct end correction. The A-weighted sound ratings shown have been calculated per AMCA International Standard 301.

Performance Curve FEG 85

ADTA 500-160-10
ADTA-F 500-160-10

60Hz 3456 rpm

Outlet Area: 0.200 m²

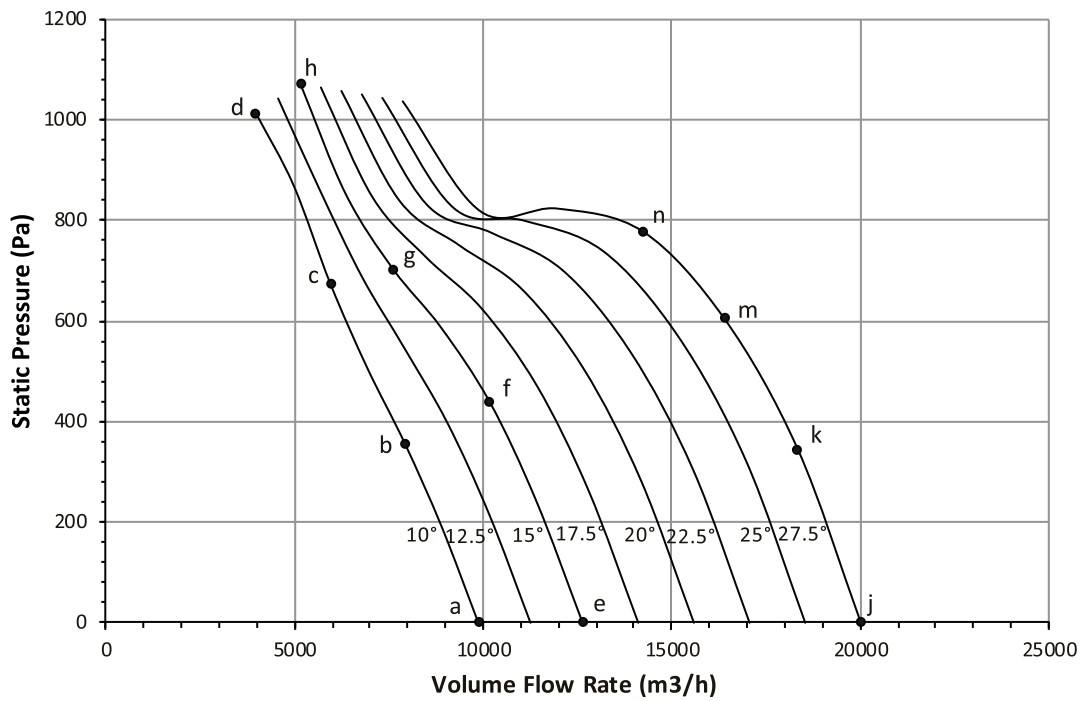
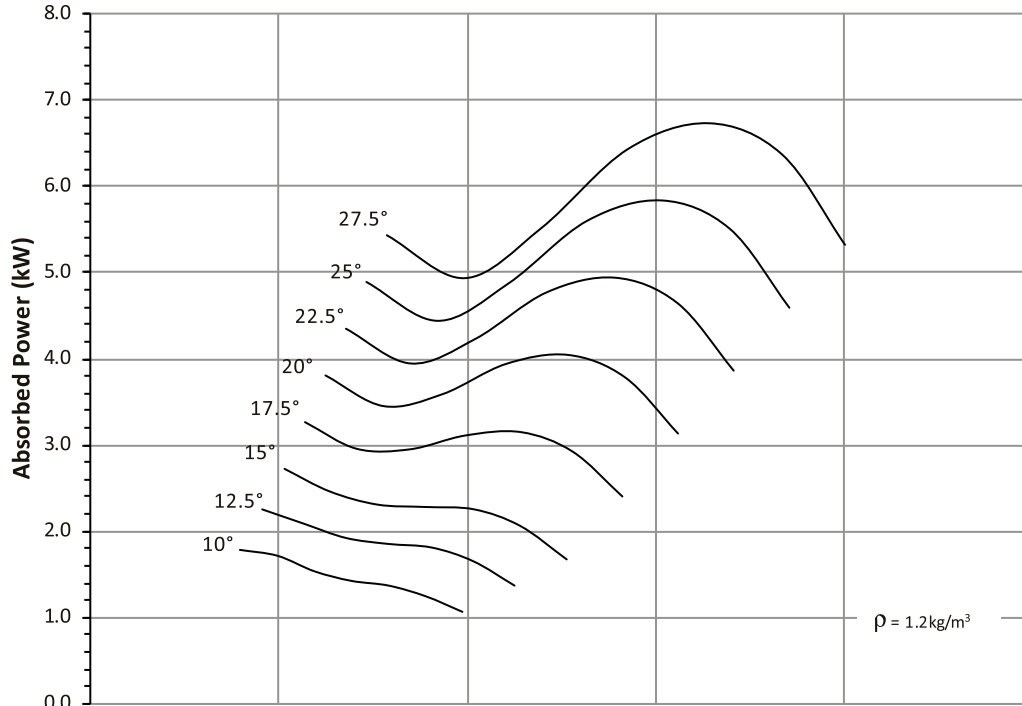

Ref	Full Octave Band Center Frequency								L _w A dB(A)
	63	125	250	500	1K	2K	4K	8K	
a	103	103	100	104	100	98	96	92	106
b	104	104	101	104	102	100	95	89	107
c	109	109	111	111	103	97	93	87	110
d	106	106	108	106	97	93	90	86	106
e	102	102	97	104	100	97	95	92	105
f	102	102	100	103	102	100	97	92	107
g	111	111	120	114	105	99	94	88	115
h	108	108	109	104	98	94	91	87	106
j	100	100	95	105	102	97	95	93	106
k	101	101	97	100	102	98	94	92	105
m	105	105	103	103	103	100	96	93	107
n	112	112	110	107	104	99	95	91	109



Performance certified is for Installation type D: Ducted Inlet- Ducted Outlet. Performance ratings do not include the effects of appurtenances (accessories) Power rating kW is fan input power. The Sound Power Level ratings shown are in decibels, referred to 10⁻¹² watts, calculated per AMCA International Standard 301. Values shown are for inlet L_w and L_wA sound power levels for Installation type D: Ducted Inlet-Ducted Outlet. Ratings include the effects of duct end correction. The A-weighted sound ratings shown have been calculated per AMCA International Standard 301.

Performance Curve
FEG 67

ADTA 560-160-10
ADTA-F 560-160-10

60Hz 3456 rpm

Outlet Area: 0.248 m²

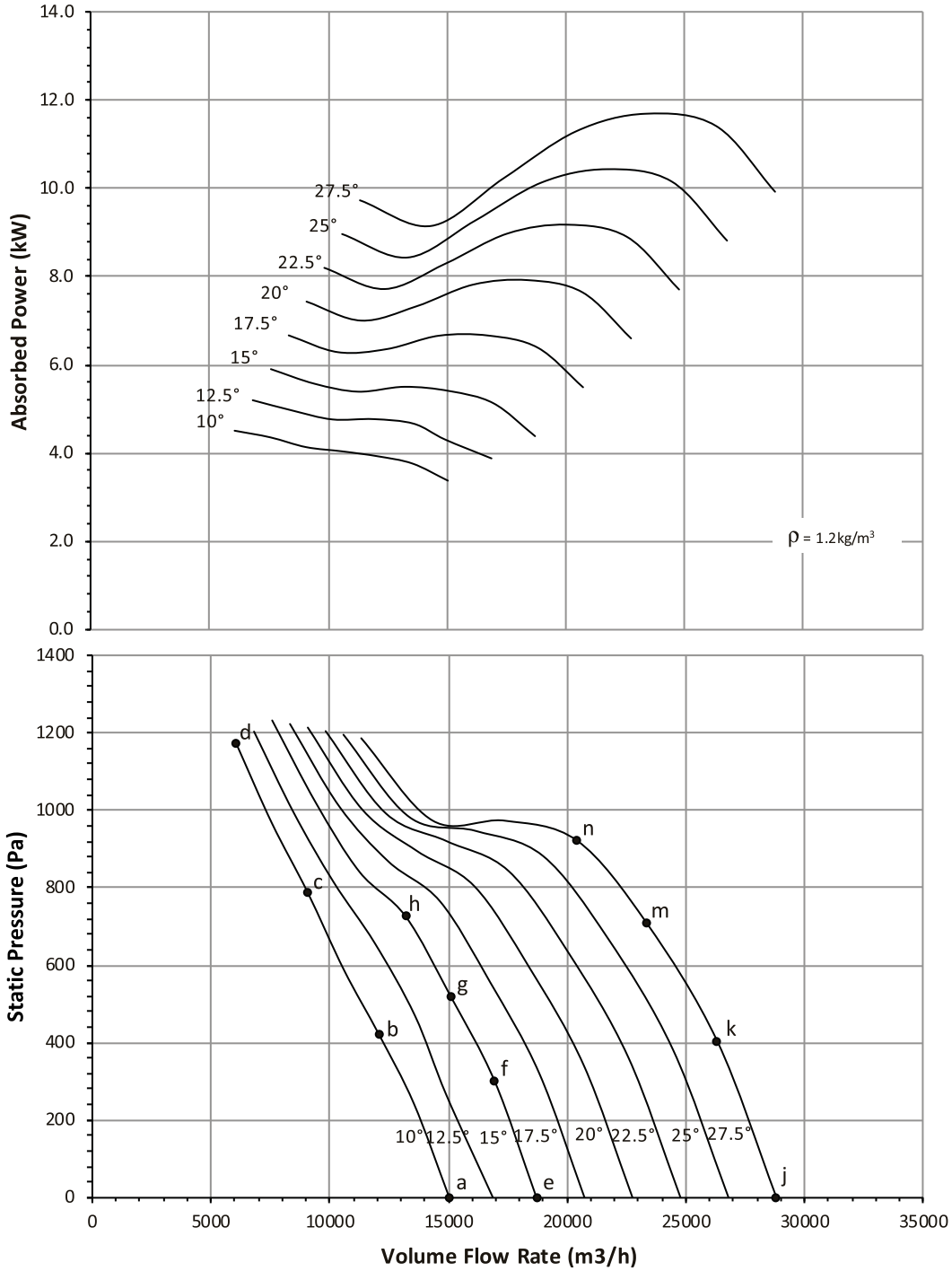

Ref	Full Octave Band Center Frequency								L _{WA} dB(A)
	63	125	250	500	1K	2K	4K	8K	
a	104	104	98	99	99	100	99	96	106
b	105	105	103	99	102	104	100	94	108
c	112	112	110	108	105	101	98	92	110
d	111	111	110	103	98	95	94	90	106
e	104	104	96	98	99	99	98	96	105
f	102	102	95	95	97	98	98	96	104
g	105	105	103	100	103	104	102	97	109
h	107	107	106	104	105	104	100	94	110
j	105	105	97	102	102	100	98	96	107
k	104	104	100	101	103	100	97	96	107
m	109	109	106	106	104	102	99	96	109
n	111	111	111	109	107	105	102	97	112



Performance certified is for Installation type D: Ducted Inlet- Ducted Outlet. Performance ratings do not include the effects of appurtenances (accessories) Power rating kW is fan input power. The Sound Power Level ratings shown are in decibels, referred to 10⁻¹² watts, calculated per AMCA International Standard 301. Values shown are for inlet L_w and L_{wA} sound power levels for Installation type D: Ducted Inlet-Ducted Outlet. Ratings include the effects of duct end correction. The A-weighted sound ratings shown have been calculated per AMCA International Standard 301.

Performance Curve FEG 90

ADTA 630-160-05
ADTA-F 630-160-05

60Hz 3456rpm

Outlet Area: 0.312 m²

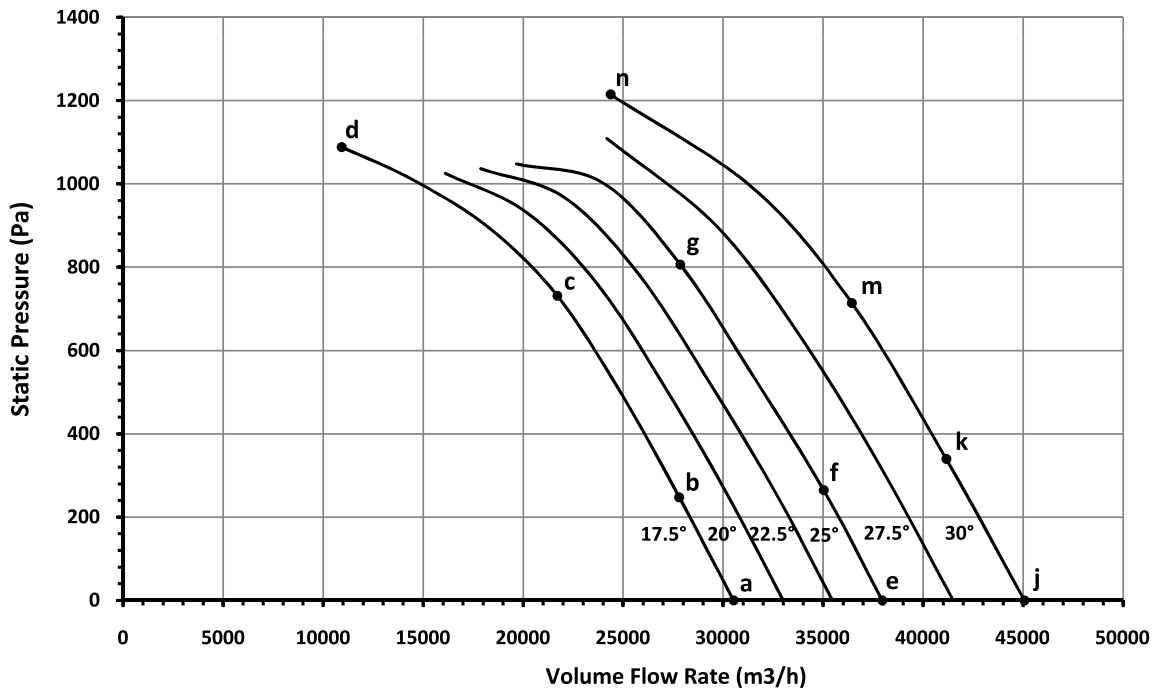
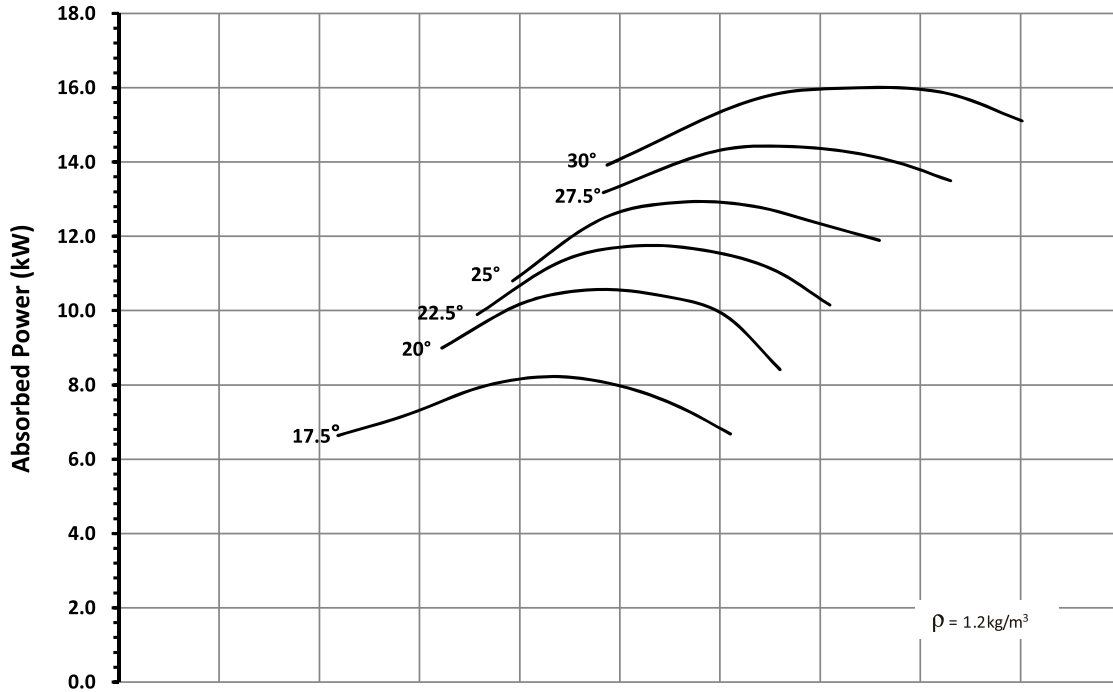

Ref	Full Octave Band Center Frequency								L _{WA}
	63	125	250	500	1K	2K	4K	8K	
a	104	104	99	95	97	96	95	94	103
b	101	101	98	95	97	96	94	94	103
c	102	102	98	97	99	100	98	96	105
d	111	111	103	108	114	109	103	98	116
e	105	105	101	98	100	98	96	95	105
f	103	103	100	98	100	98	96	95	105
g	106	106	101	98	100	98	97	96	105
j	107	107	104	100	101	100	98	96	107
k	106	106	103	99	100	99	98	96	106
m	108	108	104	98	100	100	99	97	106
n	122	122	115	106	102	100	97	94	112



Performance certified is for Installation type D: Ducted Inlet- Ducted Outlet. Performance ratings do not include the effects of appurtenances (accessories). Power rating kW is fan input power. The Sound Power Level ratings shown are in decibels, referred to 10⁻¹² watts, calculated per AMCA International Standard 301. Values shown are for inlet L_{WA} and L_{WA} sound power levels for Installation type D: Ducted Inlet-Ducted Outlet. Ratings include the effects of duct end correction. The A-weighted sound ratings shown have been calculated per AMCA International Standard 301.

Performance Curve
FEG 60

ADTA 630-230-12
ADTA-F 630-230-12

60Hz 3456 rpm

Outlet Area: 0.312 m²

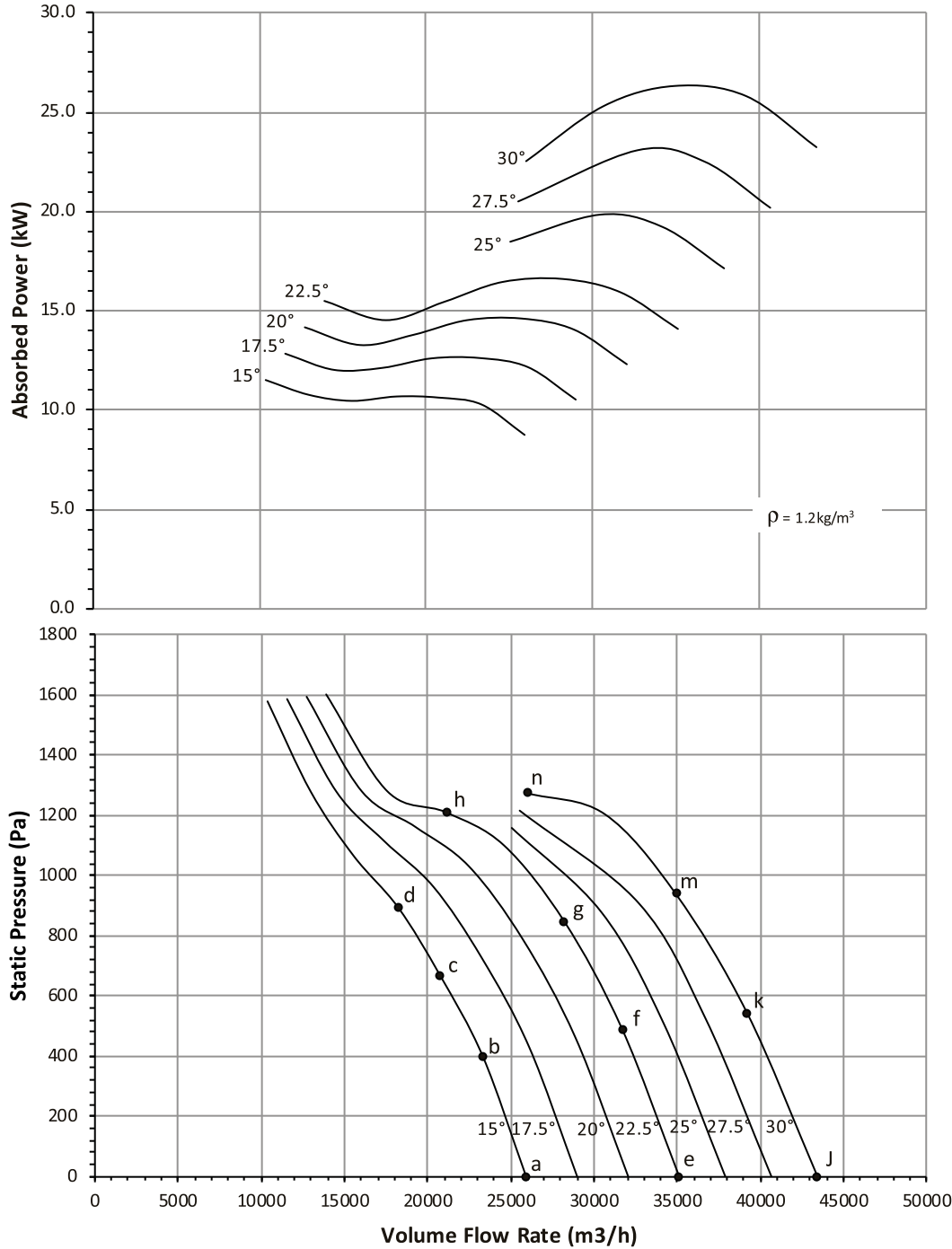

Ref	Full Octave Band Center Frequency								L _w A dB(A)
	63	125	250	500	1K	2K	4K	8K	
a	106	106	99	99	101	101	101	101	108
b	106	106	98	99	100	101	101	101	108
c	108	108	101	105	106	107	106	101	113
d	110	110	104	112	111	109	105	99	115
e	109	109	99	99	101	101	100	100	107
f	110	110	101	101	101	100	99	99	107
g	112	112	104	107	105	104	103	100	111
h	113	113	109	117	113	111	105	100	118
j	110	110	101	102	103	102	100	100	109
k	110	110	103	103	104	102	100	99	109
m	111	111	106	106	107	105	103	100	112
n	116	116	118	115	113	110	106	100	118



Performance certified is for Installation type D: Ducted Inlet- Ducted Outlet. Performance ratings do not include the effects of appurtenances (accessories)
Power rating kW is fan input power.
The Sound Power Level ratings shown are in decibels, referred to 10⁻¹² watts, calculated per AMCA International Standard 301. Values shown are for inlet L_w and L_wA sound power levels for Installation type D: Ducted Inlet-Ducted Outlet. Ratings include the effects of duct end correction.
The A-weighted sound ratings shown have been calculated per AMCA International Standard 301.

Performance Curve
FEG 75

ADTA 710-230-06
ADTA-F 710-230-06

60Hz 3456rpm

Outlet Area: 0.396 m²

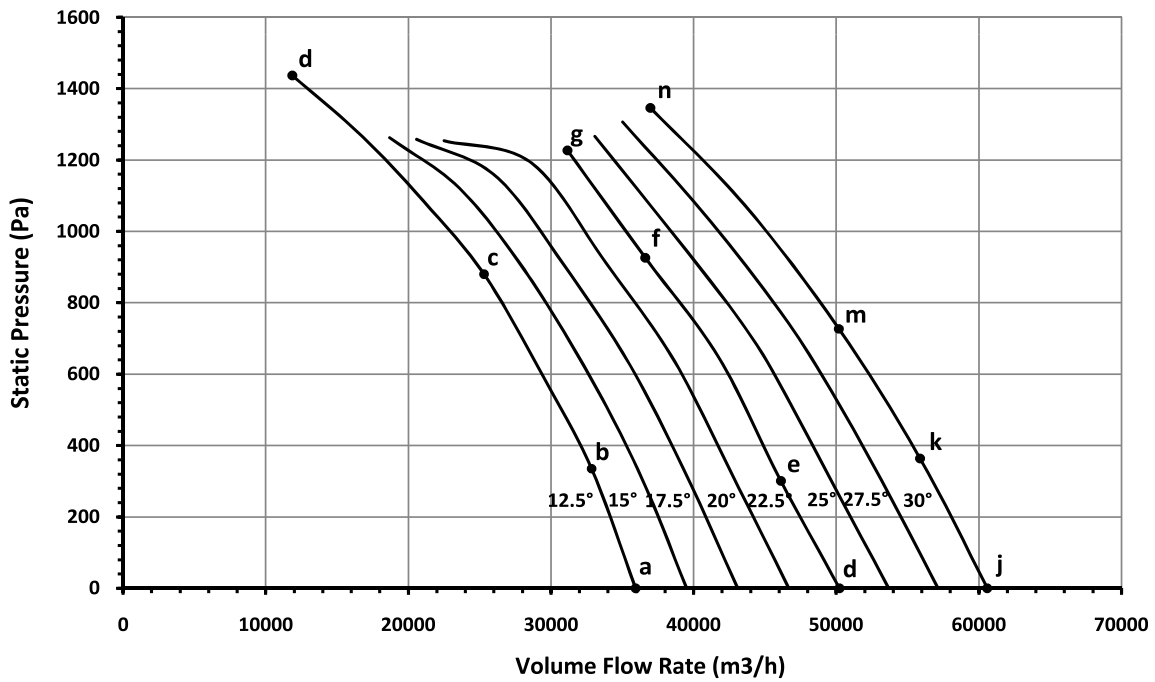
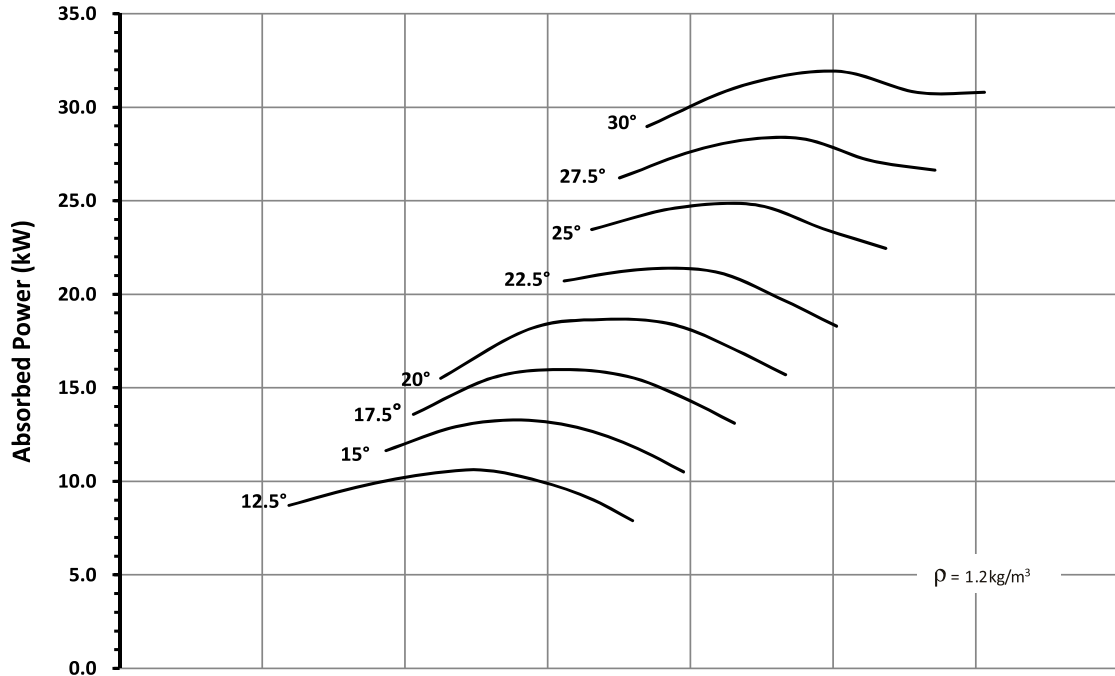

Ref	Full Octave Band Center Frequency								L _{WA} dB(A)
	63	125	250	500	1K	2K	4K	8K	
a	98	98	97	96	99	99	98	98	105
b	95	95	96	96	98	98	97	96	104
c	102	102	98	98	105	108	106	101	112
d	105	105	101	106	114	111	106	101	117
e	104	104	104	107	104	103	100	99	110
f	103	103	104	101	102	102	101	99	108
g	103	103	103	100	101	102	102	100	109
h	102	102	103	100	102	104	103	100	110
j	108	108	106	104	104	105	103	100	111
k	107	107	105	104	104	104	103	100	110
m	108	108	106	103	103	103	103	100	110
n	107	107	106	105	105	105	104	101	111



Performance certified is for Installation type D: Ducted Inlet- Ducted Outlet. Performance ratings do not include the effects of appurtenances (accessories) Power rating kW is fan input power. The Sound Power Level ratings shown are in decibels, referred to 10⁻¹² watts, calculated per AMCA International Standard 301. Values shown are for inlet L_w and L_{wA} sound power levels for Installation type D: Ducted Inlet-Ducted Outlet. Ratings include the effects of duct end correction. The A-weighted sound ratings shown have been calculated per AMCA International Standard 301.

Performance Curve
FEG 56

ADTA 315-110-05
ADTA-F 315-110-05

60Hz 1728 rpm

Outlet Area: 0.079 m²

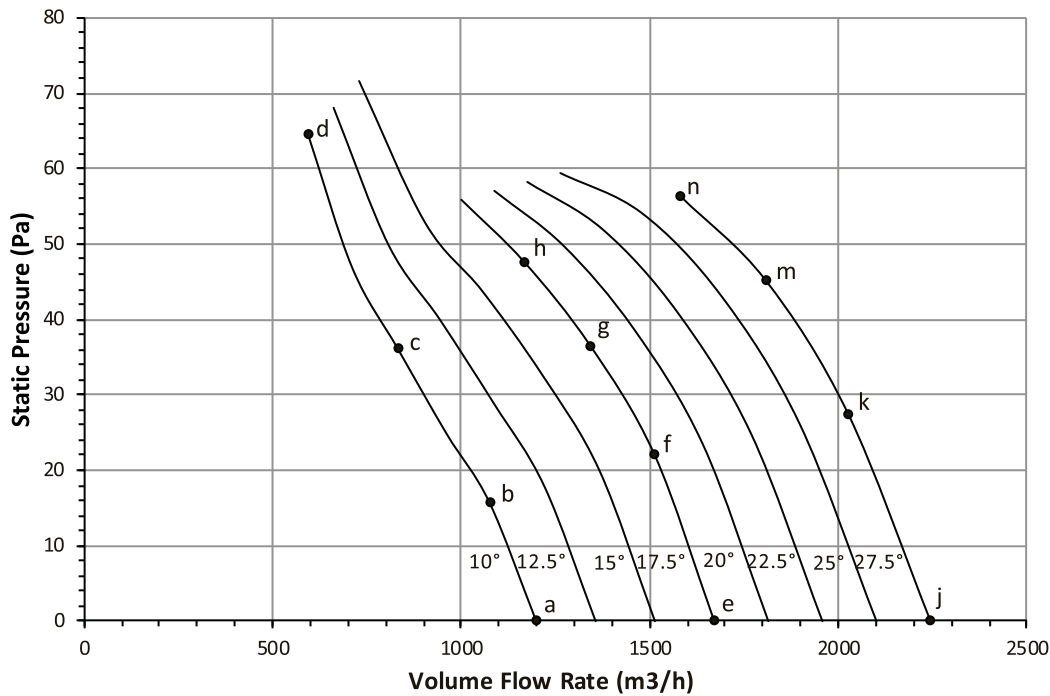
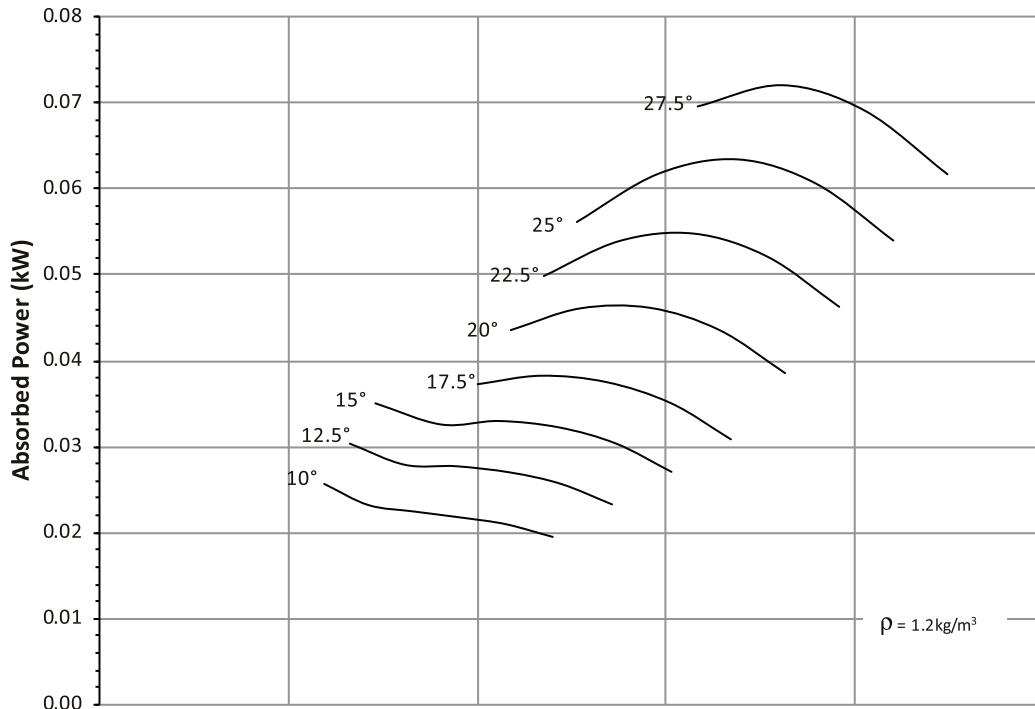

4 Pole - 1728 rpm

Ref	Full Octave Band Center Frequency								L _{WA} dB(A)
	63	125	250	500	1K	2K	4K	8K	
a	75	67	66	66	65	62	59	56	70
b	75	67	65	67	66	62	58	54	70
c	75	71	76	74	69	63	58	53	75
d	79	77	71	68	63	60	56	52	70
e	73	69	63	65	64	63	59	55	69
f	73	67	63	65	63	62	59	56	69
g	73	69	69	70	67	64	60	57	72
h	75	75	76	75	71	65	60	55	76
j	74	68	65	67	64	62	60	57	70
k	78	69	64	67	64	62	60	56	70
m	78	71	66	68	66	63	61	60	71
n	78	74	70	70	67	63	61	60	72



Performance certified is for Installation type D: Ducted Inlet- Ducted Outlet. Performance ratings do not include the effects of appurtenances (accessories) Power rating kW is fan input power. The Sound Power Level ratings shown are in decibels, referred to 10⁻¹² watts, calculated per AMCA International Standard 301. Values shown are for inlet L_W and L_{WA} sound power levels for Installation type D: Ducted Inlet-Ducted Outlet. Ratings include the effects of duct end correction. The A-weighted sound ratings shown have been calculated per AMCA International Standard 301.

Performance Curve FEG 67

ADTA 400-160-10
ADTA-F 400-160-10

60Hz 1728 rpm

Outlet Area: 0.129 m²

4 Pole - 1728 rpm

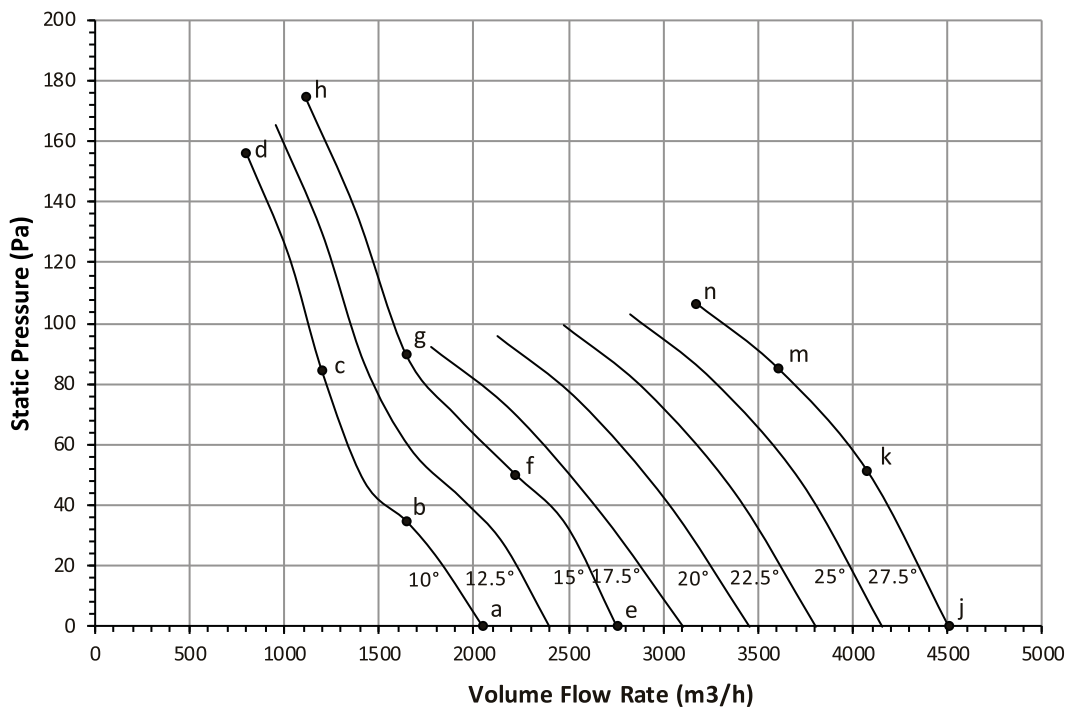
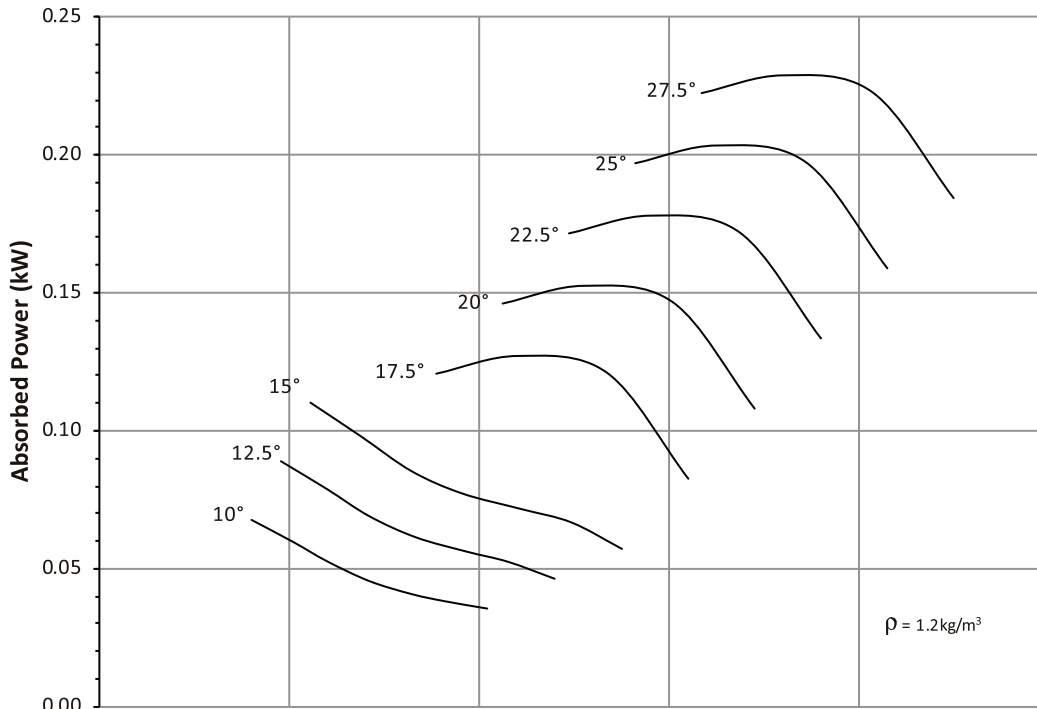

Ref	Full Octave Band Center Frequency								L _W A dB(A)
	63	125	250	500	1K	2K	4K	8K	
a	82	80	83	79	76	72	67	61	81
b	83	82	88	82	78	72	66	59	84
c	85	84	83	77	73	69	64	56	80
d	86	83	82	76	73	69	64	56	79
e	82	80	85	78	74	72	68	62	81
f	83	83	88	82	78	73	67	59	84
g	87	89	89	80	76	70	64	56	84
h	85	83	80	75	71	68	63	57	78
j	84	78	79	76	75	74	70	65	80
k	84	79	79	76	74	73	70	64	80
m	84	83	82	78	76	74	70	64	82
n	86	91	88	82	79	76	69	62	85



Performance certified is for Installation type D: Ducted Inlet- Ducted Outlet. Performance ratings do not include the effects of appurtenances (accessories) Power rating kW is fan input power. The Sound Power Level ratings shown are in decibels, referred to 10⁻¹² watts, calculated per AMCA International Standard 301. Values shown are for inlet L_W and L_WA sound power levels for Installation type D: Ducted Inlet-Ducted Outlet. Ratings include the effects of duct end correction. The A-weighted sound ratings shown have been calculated per AMCA International Standard 301.

Performance Curve
FEG 85

ADTA 500-160-10
ADTA-F 500-160-10

60Hz 1728 rpm

Outlet Area: 0.200 m²

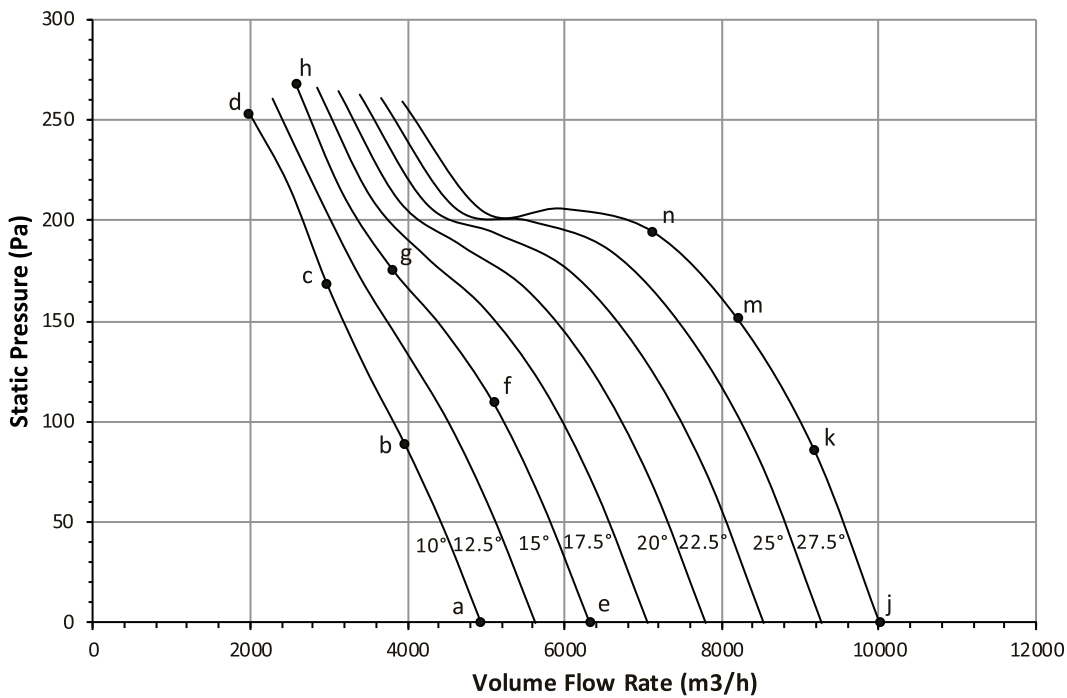
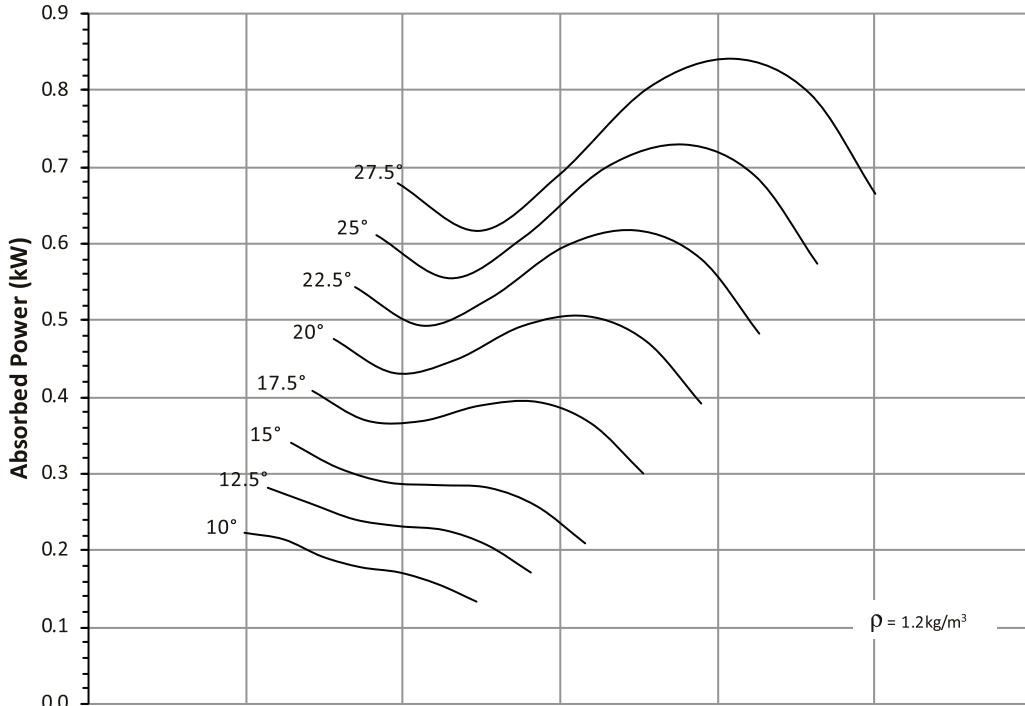

Ref	Full Octave Band Center Frequency								L _{WA} dB(A)
	63	125	250	500	1K	2K	4K	8K	
a	88	85	89	85	83	80	77	70	88
b	89	86	89	87	85	80	74	67	89
c	94	96	96	88	82	78	72	64	91
d	91	91	94	90	80	77	75	70	90
e	87	82	89	84	81	80	77	71	88
f	87	85	88	87	85	82	77	69	90
g	96	105	99	89	84	79	73	65	94
h	93	94	89	83	79	76	72	64	86
j	85	80	90	87	82	80	78	73	89
k	86	82	85	87	83	79	77	72	88
m	90	88	88	88	85	81	78	72	90
n	97	95	92	89	84	80	76	70	91



Performance certified for Installation type D: Ducted Inlet- Ducted Outlet. Performance ratings do not include the effects of appurtenances (accessories) Power rating kW is fan input power. The Sound Power Level ratings shown are in decibels, referred to 10⁻¹² watts, calculated per AMCA International Standard 301. Values shown are for inlet L_{wp} and L_{WA} sound power levels for Installation type D: Ducted Inlet-Ducted Outlet. Ratings include the effects of duct end correction. The A-weighted sound ratings shown have been calculated per AMCA International Standard 301.

4 Pole - 1728 rpm

Performance Curve FEG 67

ADTA 560-160-10
ADTA-F 560-160-10

60Hz 1728 rpm

Outlet Area: 0.248 m²

4 Pole - 1728 rpm

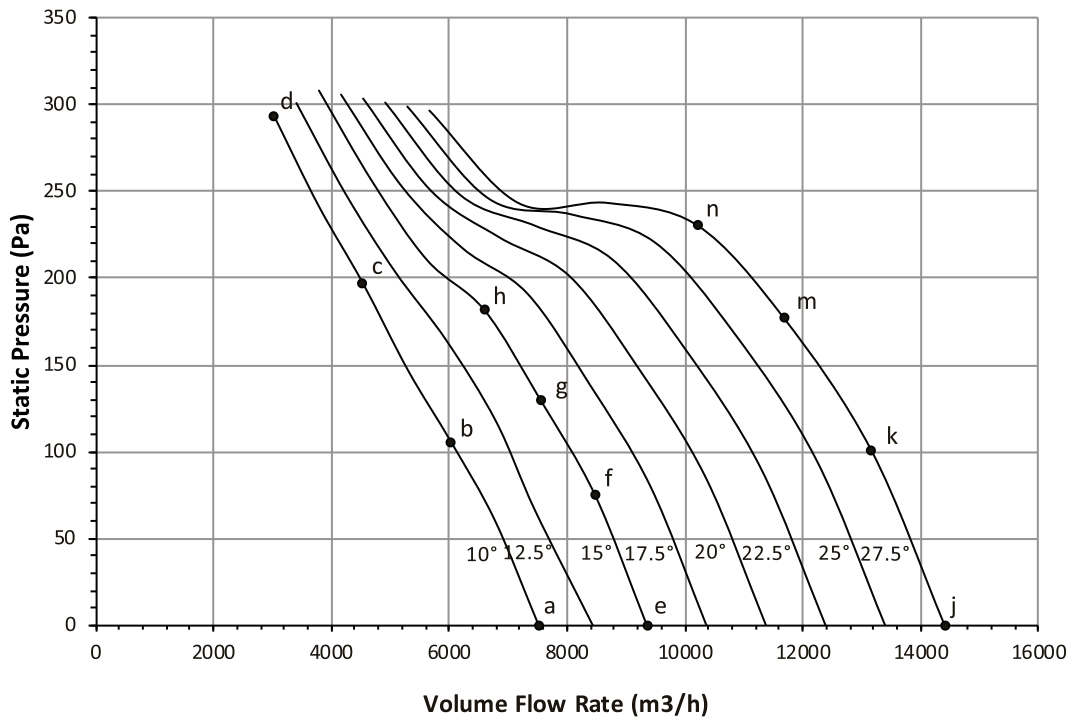
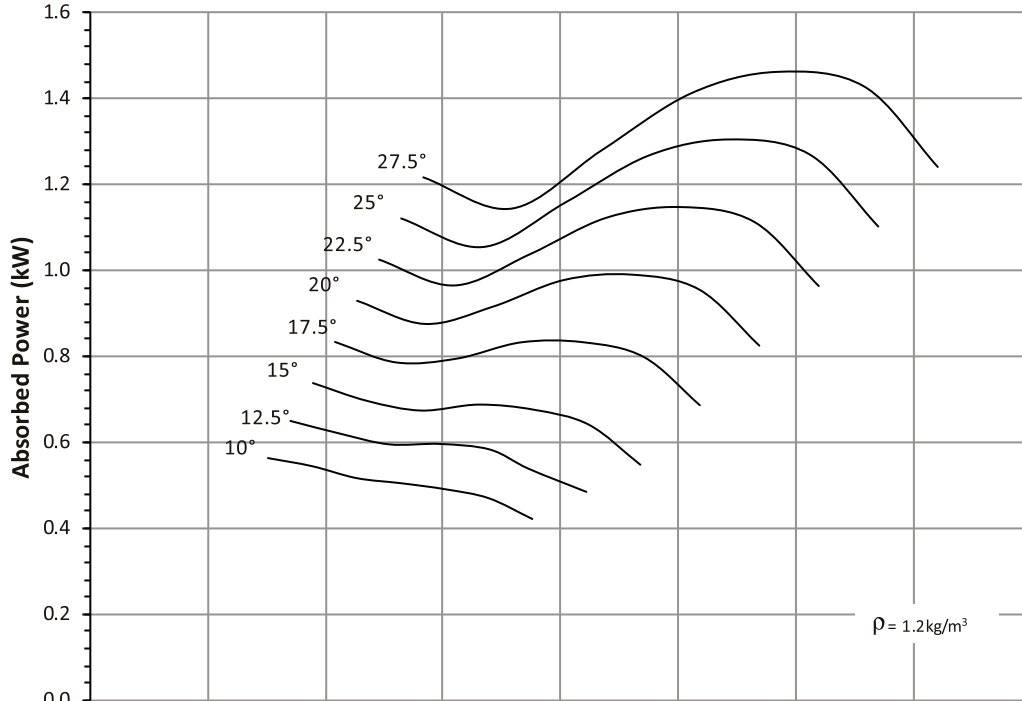

Ref	Full Octave Band Center Frequency								L _w /A
	63	125	250	500	1K	2K	4K	8K	
a	89	83	84	84	85	84	81	74	90
b	90	88	84	87	89	85	79	72	92
c	97	95	93	90	86	83	77	69	92
d	96	95	88	83	80	79	75	68	87
e	89	81	83	84	84	83	81	75	89
f	87	80	80	82	83	83	81	75	89
g	90	88	85	88	89	87	81	75	93
h	92	91	89	90	89	85	79	72	93
j	90	82	87	87	85	82	81	77	90
k	89	85	86	88	85	82	80	77	90
m	93	91	91	89	87	84	81	77	92
n	96	96	94	92	90	87	82	76	95



Performance certified for Installation type D: Ducted Inlet- Ducted Outlet. Performance ratings do not include the effects of appurtenances (accessories) Power rating kW is fan input power. The Sound Power Level ratings shown are in decibels, referred to 10⁻¹² watts, calculated per AMCA International Standard 301. Values shown are for inlet L_w and L_w/A sound power levels for Installation type D: Ducted Inlet-Ducted Outlet. Ratings include the effects of duct end correction. The A-weighted sound ratings shown have been calculated per AMCA International Standard 301.

Performance Curve
FEG 90

ADTA 630-160-05
ADTA-F 630-160-05

60Hz 1728 rpm

Outlet Area: 0.312 m²

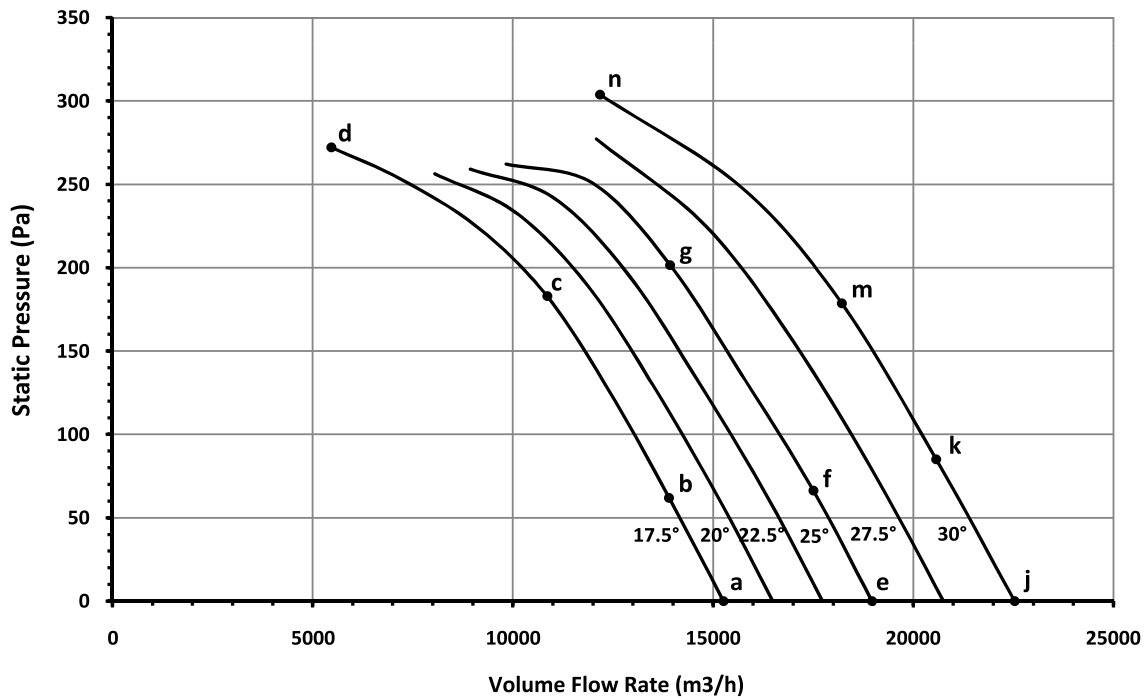
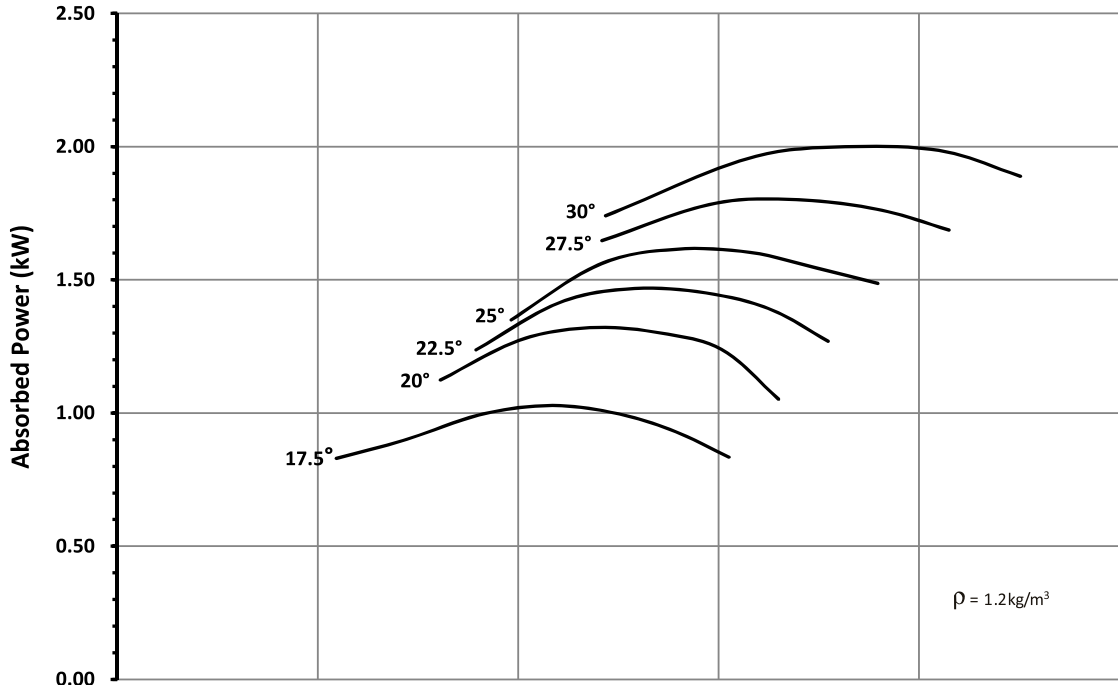

Ref	Full Octave Band Center Frequency								L _w (A)
	63	125	250	500	1K	2K	4K	8K	
a	89	82	80	82	81	80	79	78	87
b	86	83	80	82	81	79	79	77	87
c	87	83	81	84	84	83	81	78	89
d	96	88	93	99	94	88	83	77	99
e	90	86	83	85	83	81	80	78	89
f	88	85	83	85	83	81	79	78	88
g	91	86	83	85	83	82	80	78	89
j	92	89	85	86	85	83	81	79	90
k	91	88	84	85	84	83	81	78	89
m	93	89	83	84	85	84	82	79	90
n	107	100	91	87	85	82	79	74	91



Performance certified is for Installation type D: Ducted Inlet- Ducted Outlet. Performance ratings do not include the effects of appurtenances (accessories) Power rating kW is fan input power. The Sound Power Level ratings shown are in decibels, referred to 10⁻¹² watts, calculated per AMCA International Standard 301. Values shown are for inlet L_w and L_w(A) sound power levels for Installation type D: Ducted Inlet-Ducted Outlet. Ratings include the effects of duct end correction. The A-weighted sound ratings shown have been calculated per AMCA International Standard 301.

4 Pole - 1728 rpm

Performance Curve FEG 60

ADTA 630-230-12
ADTA-F 630-230-12

60Hz 1728 rpm

Outlet Area: 0.312 m²

4 Pole - 1728 rpm

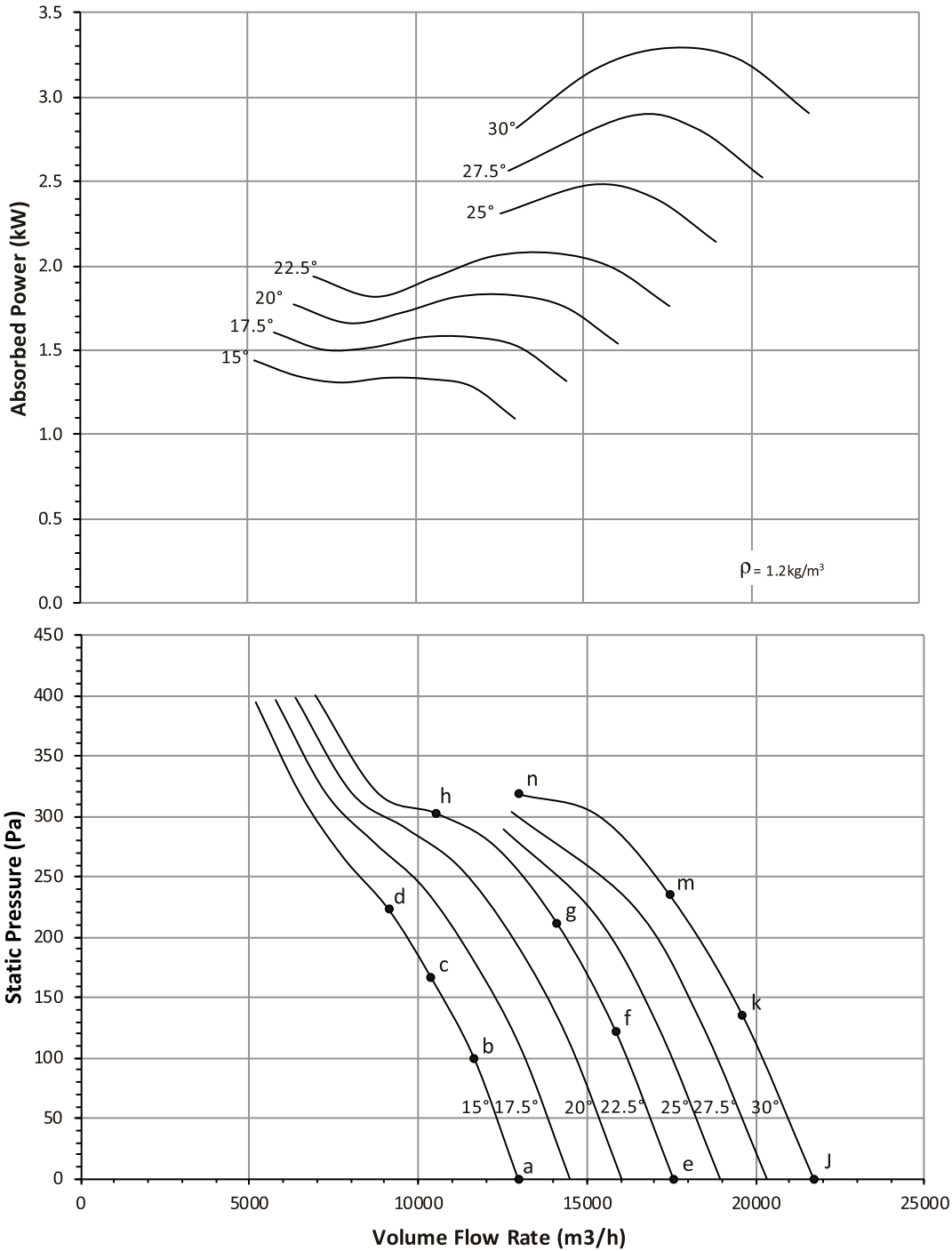

Ref	Full Octave Band Center Frequency								L _{WA} dB(A)
	63	125	250	500	1K	2K	4K	8K	
a	91	84	84	86	86	86	86	81	93
b	91	83	84	85	86	86	85	80	92
c	93	86	90	91	92	91	86	79	97
d	95	89	97	96	94	90	84	77	98
e	94	84	84	86	86	85	85	82	92
f	95	86	86	86	85	84	84	81	91
g	97	89	92	90	89	88	85	80	95
h	98	94	102	98	96	90	85	78	100
j	95	86	87	88	87	85	85	82	93
k	95	87	88	89	87	85	84	81	93
m	96	91	91	92	90	87	85	81	95
n	101	103	100	98	95	91	85	78	100



Performance certified for Installation type D: Ducted Inlet- Ducted Outlet. Performance ratings do not include the effects of appurtenances (accessories) Power rating kW is fan input power. The Sound Power Level ratings shown are in decibels, referred to 10⁻¹² watts, calculated per AMCA International Standard 301. Values shown are for inlet L_w and L_wA sound power levels for Installation type D: Ducted Inlet-Ducted Outlet. Ratings include the effects of duct end correction. The A-weighted sound ratings shown have been calculated per AMCA International Standard 301.

Performance Curve
FEG 75

ADTA 710-230-06
ADTA-F 710-230-06

60Hz 1728 rpm

Outlet Area: 0.396 m²

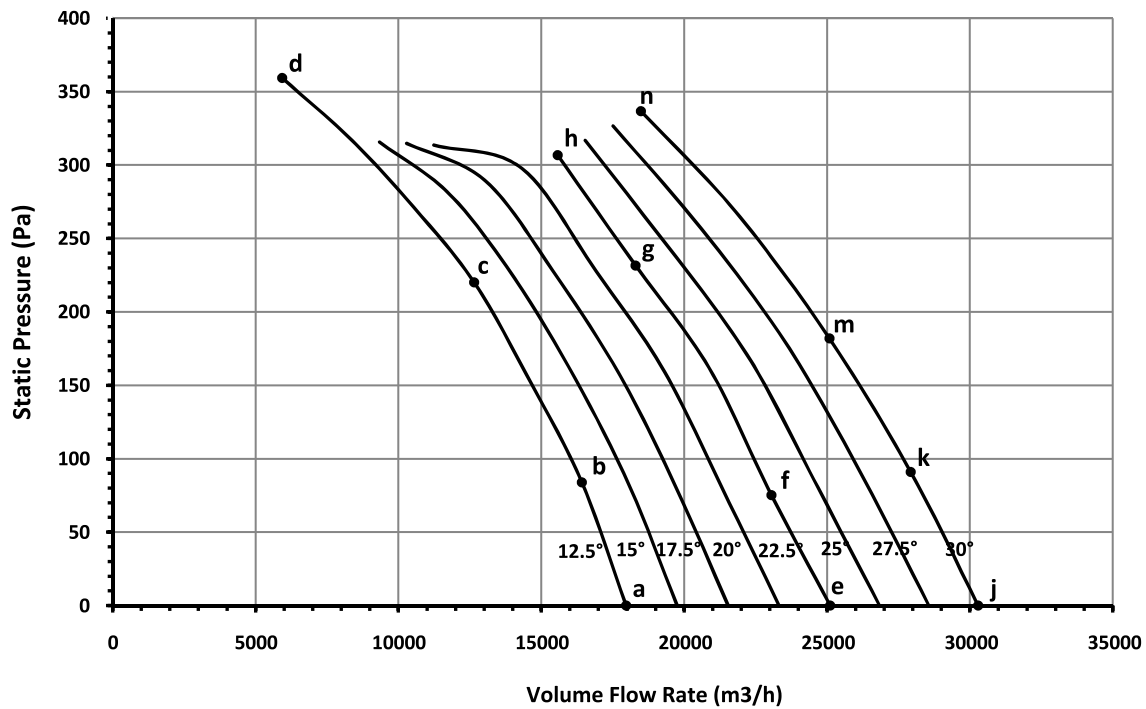
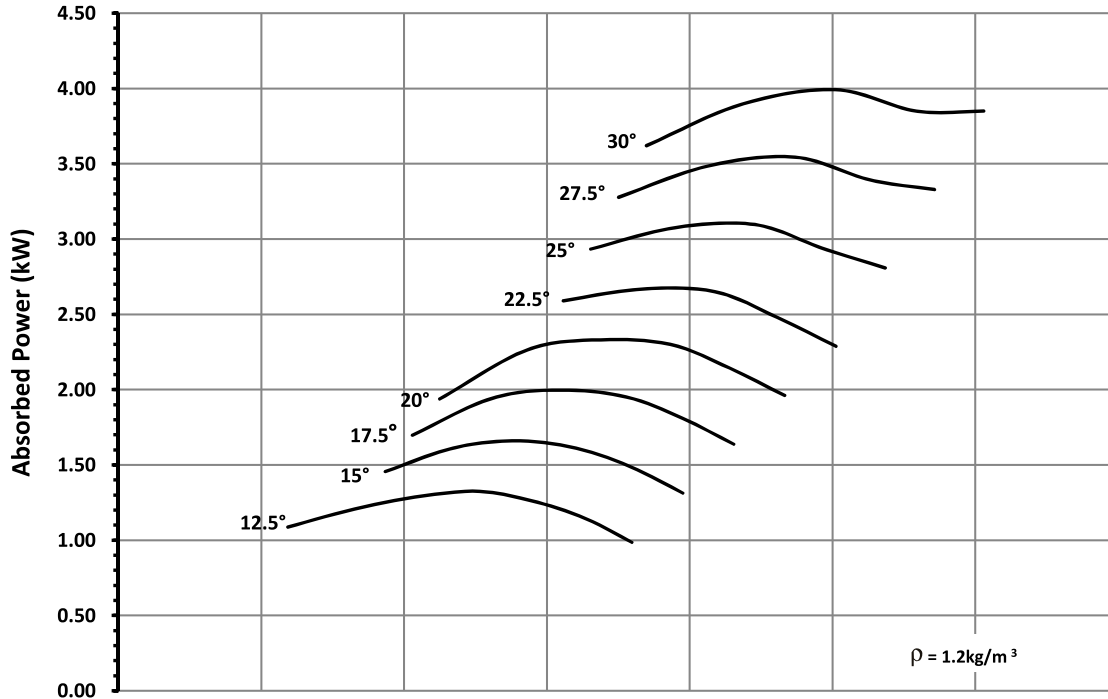

4 Pole - 1728 rpm

Ref	Full Octave Band Center Frequency								L _w A dB(A)
	63	125	250	500	1K	2K	4K	8K	
a	83	82	81	84	84	83	83	82	90
b	80	81	80	83	83	82	81	80	89
c	87	83	83	90	93	91	86	81	97
d	90	86	90	99	96	91	85	80	100
e	89	89	91	89	88	85	84	82	93
f	88	89	86	87	87	86	84	81	92
g	88	88	85	86	87	87	85	81	93
h	87	88	85	87	89	88	85	81	94
j	93	91	89	89	90	88	85	82	95
k	92	90	89	89	89	88	85	82	94
m	93	91	88	88	88	88	85	82	94
n	92	91	90	90	90	89	86	82	95



Performance certified is for Installation type D: Ducted Inlet- Ducted Outlet. Performance ratings do not include the effects of appurtenances (accessories) Power rating kW is fan input power. The Sound Power Level ratings shown are in decibels, referred to 10⁻¹² watts, calculated per AMCA International Standard 301. Values shown are for inlet L_w and L_wA sound power levels for Installation type D: Ducted Inlet-Ducted Outlet. Ratings include the effects of duct end correction. The A-weighted sound ratings shown have been calculated per AMCA International Standard 301.

4 Pole - 1728 rpm

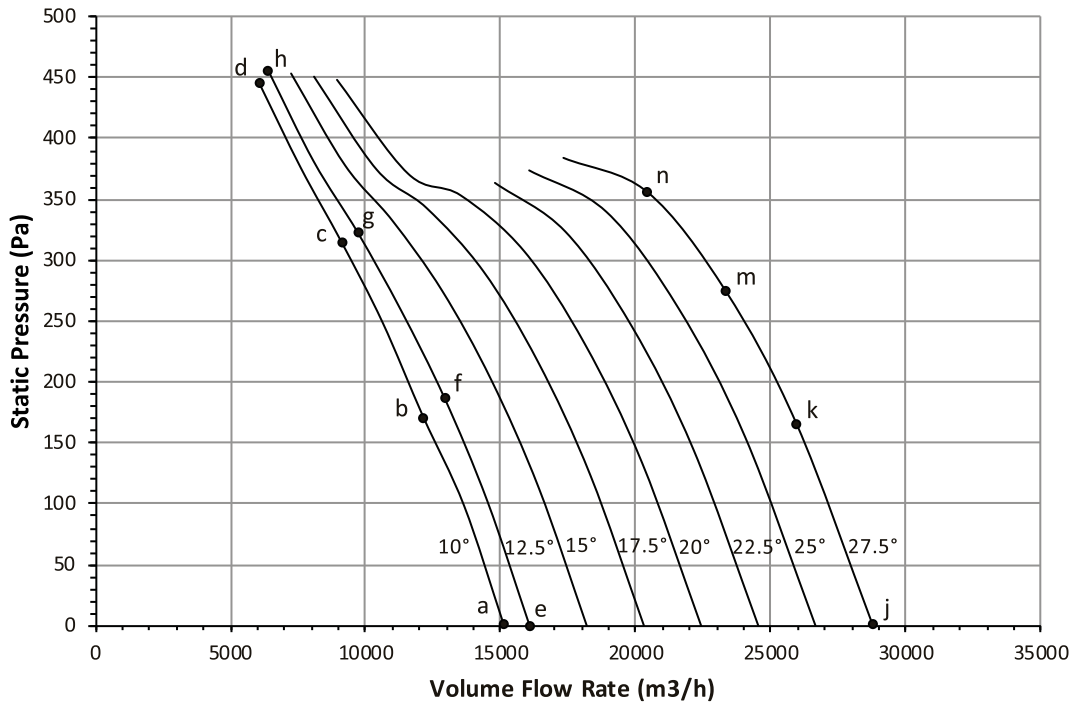
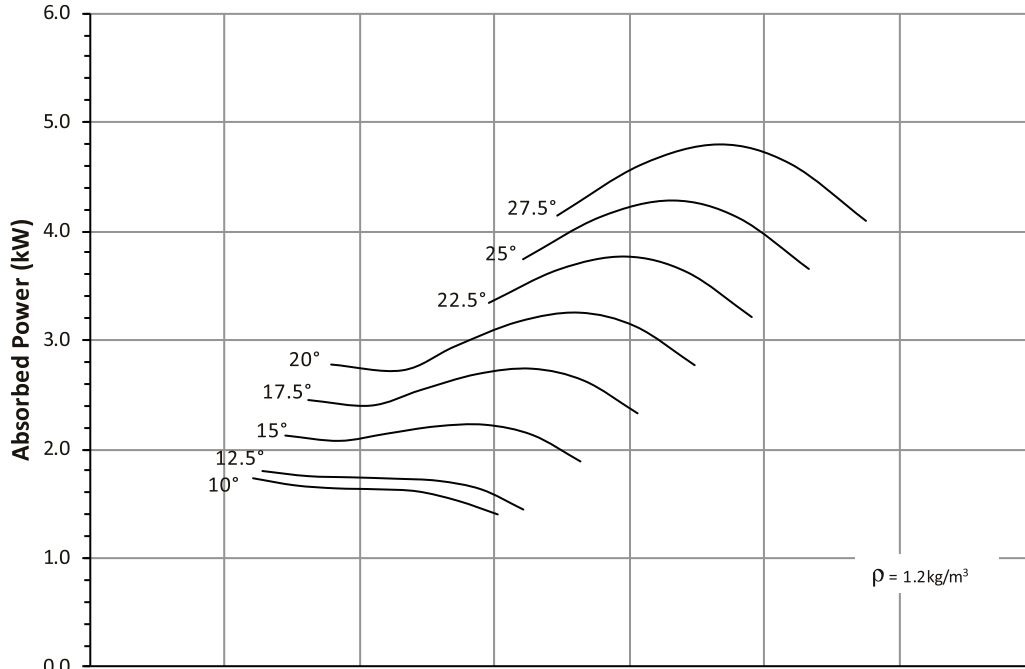

Ref	Full Octave Band Center Frequency								L _{WA} dB(A)
	63	125	250	500	1K	2K	4K	8K	
a	92	86	87	89	91	91	88	84	96
b	93	87	88	94	96	93	88	83	100
c	98	91	99	97	94	91	86	79	99
d	102	92	94	89	87	85	83	77	93
e	91	86	87	89	90	90	89	85	96
f	92	86	88	95	96	93	88	83	99
g	98	91	100	97	95	91	85	79	100
h	103	93	94	89	87	85	82	77	93
j	94	87	94	91	90	88	87	85	96
k	95	88	95	93	91	89	88	85	97
m	96	91	95	98	96	92	89	85	100
n	99	97	100	100	98	95	90	84	103



Performance certified is for Installation type D: Ducted Inlet- Ducted Outlet. Performance ratings do not include the effects of appurtenances (accessories). Power rating kW is fan input power. The Sound Power Level ratings shown are in decibels, referred to 10⁻¹² watts, calculated per AMCA International Standard 301. Values shown are for inlet L_{WA} and L_{WA} sound power levels for Installation type D: Ducted Inlet-Ducted Outlet. Ratings include the effects of duct end correction. The A-weighted sound ratings shown have been calculated per AMCA International Standard 301.

Performance Curve

ADTA 710-250-12
ADTA-F 710-250-12

60Hz 1728 rpm

FEG 71

Outlet Area: 0.396 m²

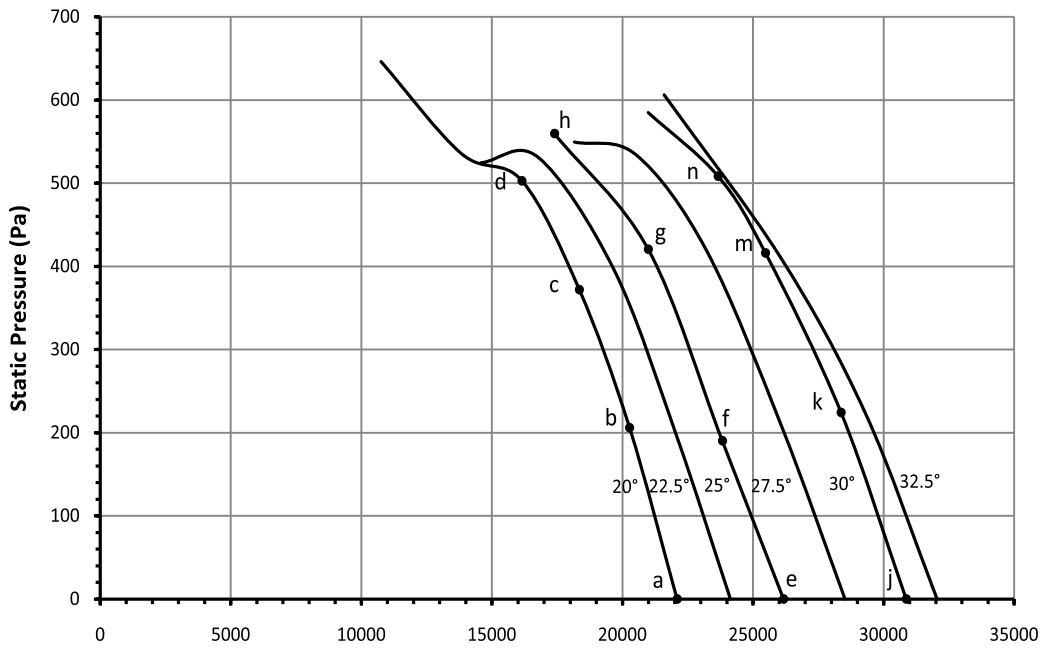
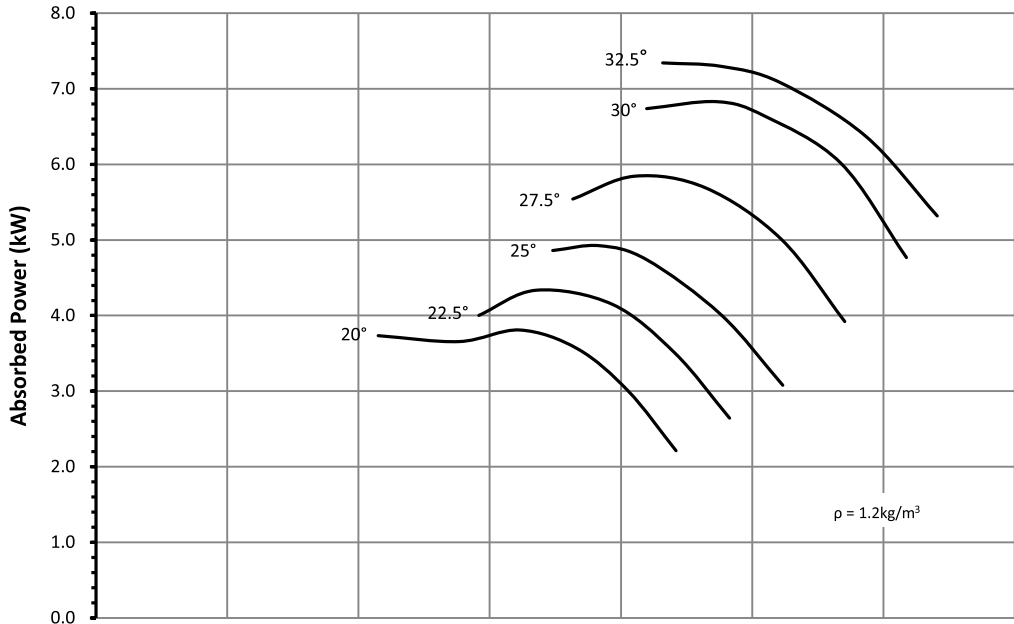

Volume Flow Rate (m³/h)

Ref	Full Octave Band Center Frequency								L _w /A dB(A)
	63	125	250	500	1K	2K	4K	8K	
a	96	86	90	90	88	87	87	79	94
b	96	86	89	88	87	86	85	79	93
c	90	85	89	91	90	88	85	79	95
d	92	90	93	99	96	92	87	80	100
e	93	87	90	90	89	88	87	81	95
f	94	87	90	89	89	87	85	81	94
g	94	87	90	91	89	88	84	82	94
h	97	97	99	100	97	92	87	82	101
j	95	89	91	92	91	89	87	88	96
k	96	89	92	91	90	87	85	84	95
m	96	88	93	91	89	87	83	81	95
n	97	93	96	94	92	89	85	82	97



Performance certified for Installation type D: Ducted Inlet- Ducted Outlet. Performance ratings do not include the effects of appurtenances (accessories). Power rating kW is fan input power. The Sound Power Level ratings shown are in decibels, referred to 10-12 watts, calculated per AMCA International Standard 301. Values shown are for inlet LWI and LWIA sound power levels for Installation type D: Ducted Inlet-Ducted Outlet. Ratings include the effects of duct end correction. The A-weighted sound ratings shown have been calculated per AMCA International Standard 301.

4 Pole - 1728 rpm

4 Pole - 1728 rpm

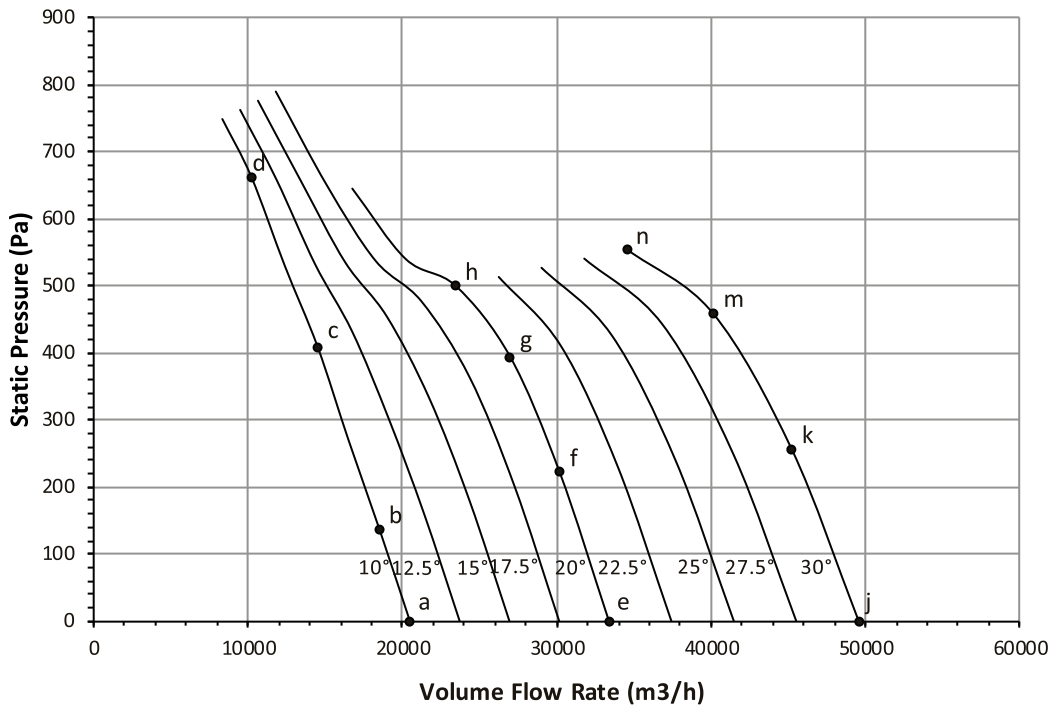
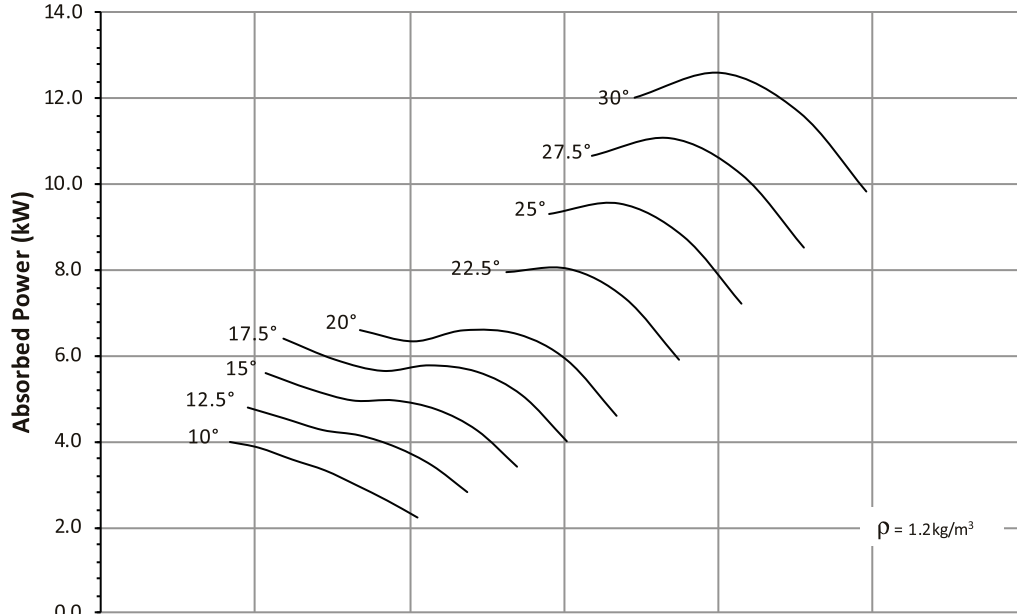

Ref	Full Octave Band Center Frequency								L _w A dB(A)
	63	125	250	500	1K	2K	4K	8K	
a	92	88	94	93	93	92	93	82	99
b	92	88	94	94	98	96	94	82	102
c	97	95	102	102	99	94	89	78	103
d	102	98	102	97	94	90	84	76	100
e	93	88	96	94	93	92	95	83	100
f	94	89	97	94	94	94	94	84	100
g	97	95	99	100	100	97	93	84	104
h	99	103	107	103	101	97	88	81	106
j	94	91	98	96	95	93	94	83	101
k	93	91	97	96	95	94	91	84	100
m	94	96	98	97	97	95	91	86	102
n	97	108	106	102	101	98	93	86	106



Performance certified is for Installation type D: Ducted Inlet- Ducted Outlet. Performance ratings do not include the effects of appurtenances (accessories) Power rating kW is fan input power. The Sound Power Level ratings shown are in decibels, referred to 10⁻¹² watts, calculated per AMCA International Standard 301. Values shown are for inlet L_w and L_wA sound power levels for Installation type D: Ducted Inlet-Ducted Outlet. Ratings include the effects of duct end correction. The A-weighted sound ratings shown have been calculated per AMCA International Standard 301.

Performance Curve FEG 75

ADTA 800-250-12-T
ADTA-F 800-250-12-T

60Hz 1728 rpm

Outlet Area: 0.503 m²

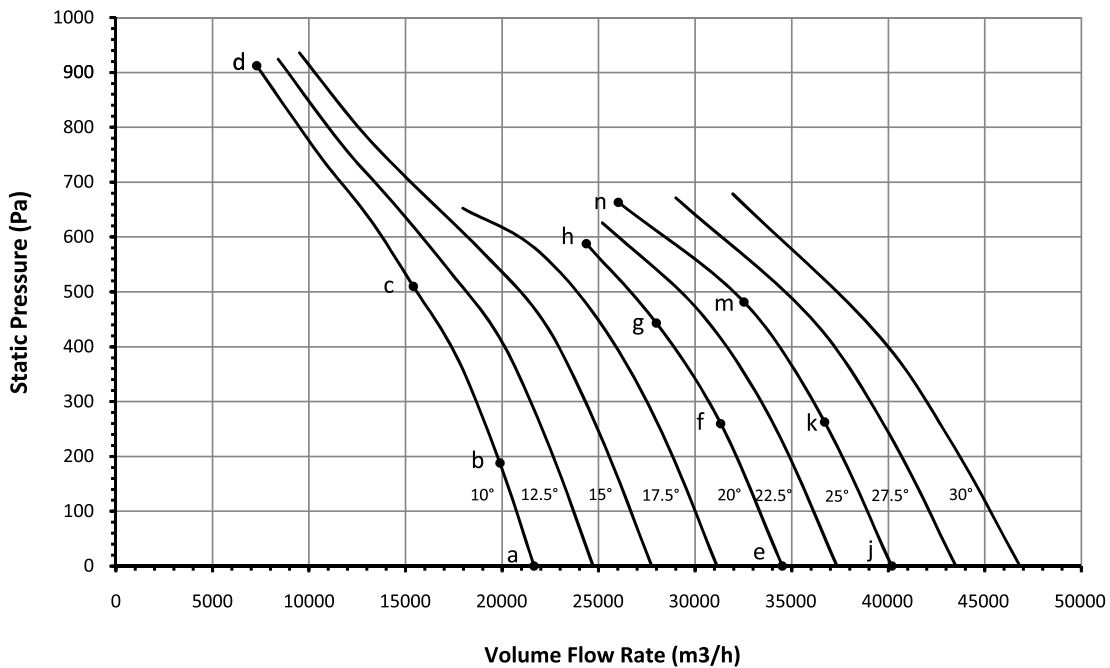
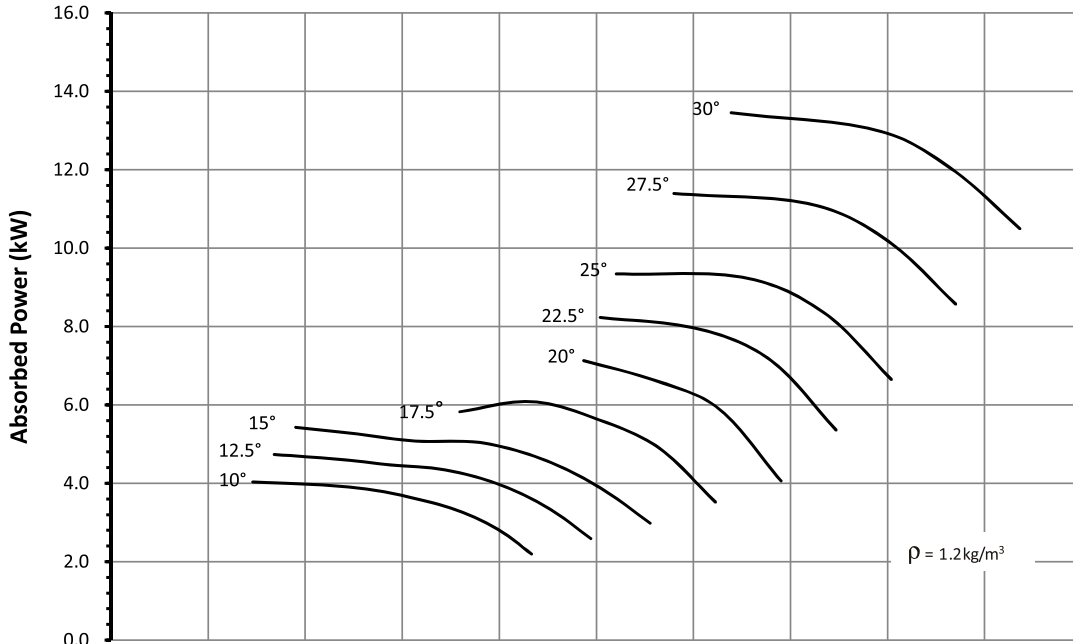

Ref	Full Octave Band Center Frequency								L _{wi} A dB(A)
	63	125	250	500	1K	2K	4K	8K	
a	94	90	94	93	92	90	91	83	98
b	93	89	93	91	91	92	91	84	98
c	92	90	98	99	100	95	90	82	103
d	97	93	100	95	92	88	84	80	98
e	94	90	99	96	94	91	91	84	99
f	92	89	97	95	93	91	90	84	99
g	92	90	97	99	98	96	92	85	103
h	95	95	100	103	101	97	91	85	105
j	96	92	101	97	95	92	90	96	101
k	95	91	100	96	94	91	89	95	100
m	96	91	98	97	95	92	89	95	101
n	97	103	102	103	101	96	91	91	105



Performance certified is for Installation type D: Ducted Inlet- Ducted Outlet. Performance ratings do not include the effects of appurtenances (accessories) Power rating kW is fan input power. The Sound Power Level ratings shown are in decibels, referred to 10-12 watts, calculated per AMCA International Standard 301. Values shown are for inlet LWi and LWiA sound power levels for Installation type D: Ducted Inlet-Ducted Outlet. Ratings include the effects of duct end correction. The A-weighted sound ratings shown have been calculated per AMCA International Standard 301.

4 Pole - 1728 rpm

Performance Curve FEG 60

ADTA 900-400-8
ADTA-F 900-400-8

60Hz 1728 rpm

Outlet Area: 0.636 m²

4 Pole - 1728 rpm

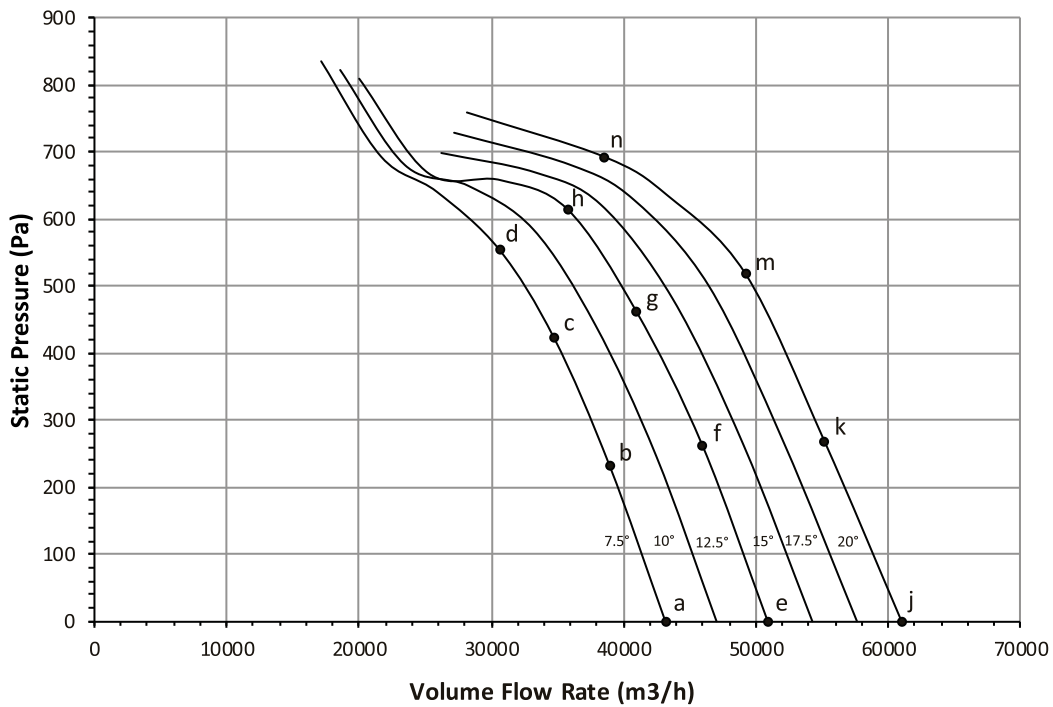
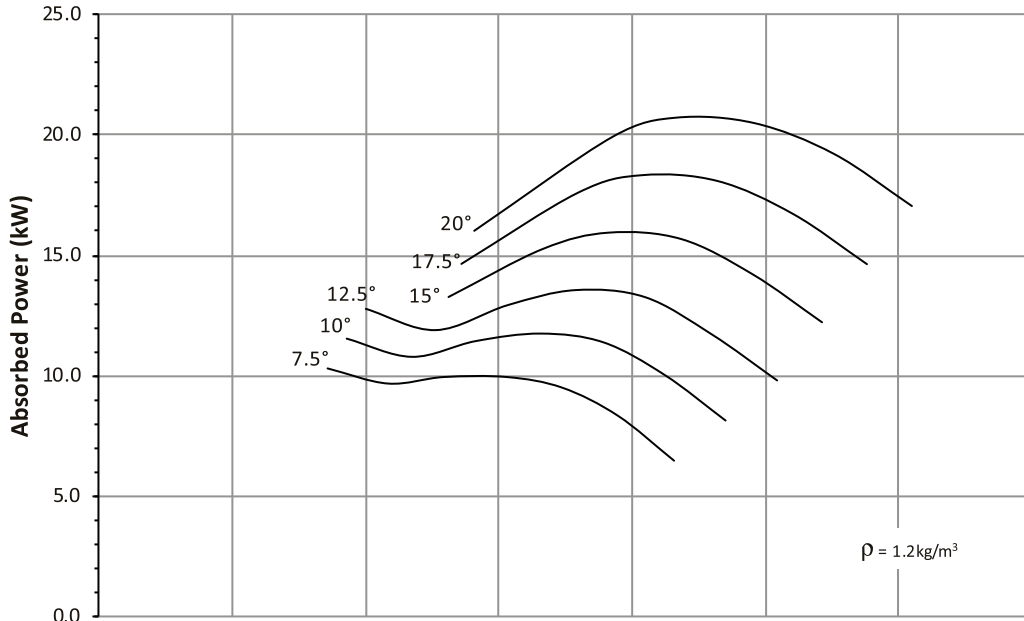

Ref	Full Octave Band Center Frequency								L _w A dB(A)
	63	125	250	500	1K	2K	4K	8K	
a	95	92	97	98	94	90	89	86	100
b	90	91	95	98	95	91	89	85	100
c	93	93	96	100	98	95	92	87	103
d	95	98	102	105	104	101	94	87	108
e	94	93	98	99	95	91	89	85	101
f	94	94	97	98	95	92	89	84	100
g	95	96	98	100	98	95	92	87	103
h	97	99	105	106	104	99	94	88	108
j	97	97	102	101	98	94	90	85	103
k	98	99	102	100	98	94	91	86	103
m	98	99	101	100	98	95	92	88	103
n	99	102	105	104	102	99	95	91	107



Performance certified is for Installation type D: Ducted Inlet- Ducted Outlet. Performance ratings do not include the effects of appurtenances (accessories) Power rating kW is fan input power. The Sound Power Level ratings shown are in decibels, referred to 10⁻¹² watts, calculated per AMCA International Standard 301. Values shown are for inlet L_w and L_wA sound power levels for Installation type D: Ducted Inlet-Ducted Outlet. Ratings include the effects of duct end correction. The A-weighted sound ratings shown have been calculated per AMCA International Standard 301.

Performance Curve
FEG 75

ADTA 1000-250-06
ADTA-F 1000-250-06

60Hz 1728 rpm
Outlet Area: 0.785 m²

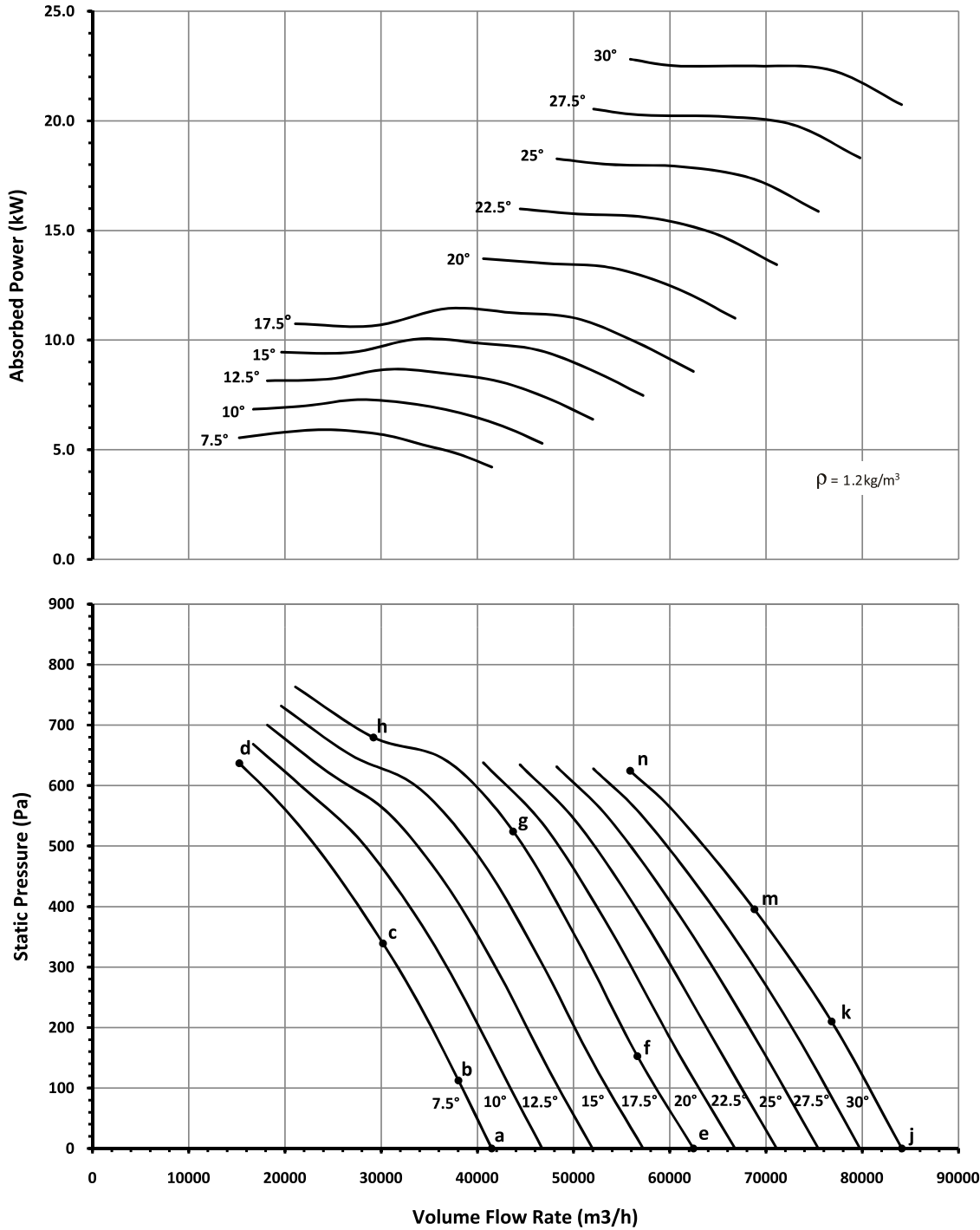

4 Pole - 1728 rpm

Ref	Full Octave Band Center Frequency								L _w A dB(A)
	63	125	250	500	1K	2K	4K	8K	
a	86	92	96	97	97	94	94	90	102
b	85	92	94	96	98	97	95	91	103
c	87	91	93	101	103	100	95	89	107
d	92	98	109	108	102	96	91	86	108
e	97	96	99	99	97	93	93	91	102
f	96	95	97	98	97	94	92	88	101
g	97	94	97	104	105	100	95	90	108
h	98	96	106	113	110	103	97	90	114
j	98	99	102	103	101	97	94	92	106
k	98	99	102	102	101	97	94	92	105
m	99	98	101	101	100	98	95	93	105
n	100	99	102	104	103	100	96	94	107



Performance certified is for Installation type D: Ducted Inlet- Ducted Outlet. Performance ratings do not include the effects of appurtenances (accessories) Power rating kW is fan input power. The Sound Power Level ratings shown are in decibels, referred to 10⁻¹² watts, calculated per AMCA International Standard 301. Values shown are for inlet L_{wi} and L_wA sound power levels for Installation type D: Ducted Inlet-Ducted Outlet. Ratings include the effects of duct end correction. The A-weighted sound ratings shown have been calculated per AMCA International Standard 301.

4 Pole - 1728 rpm

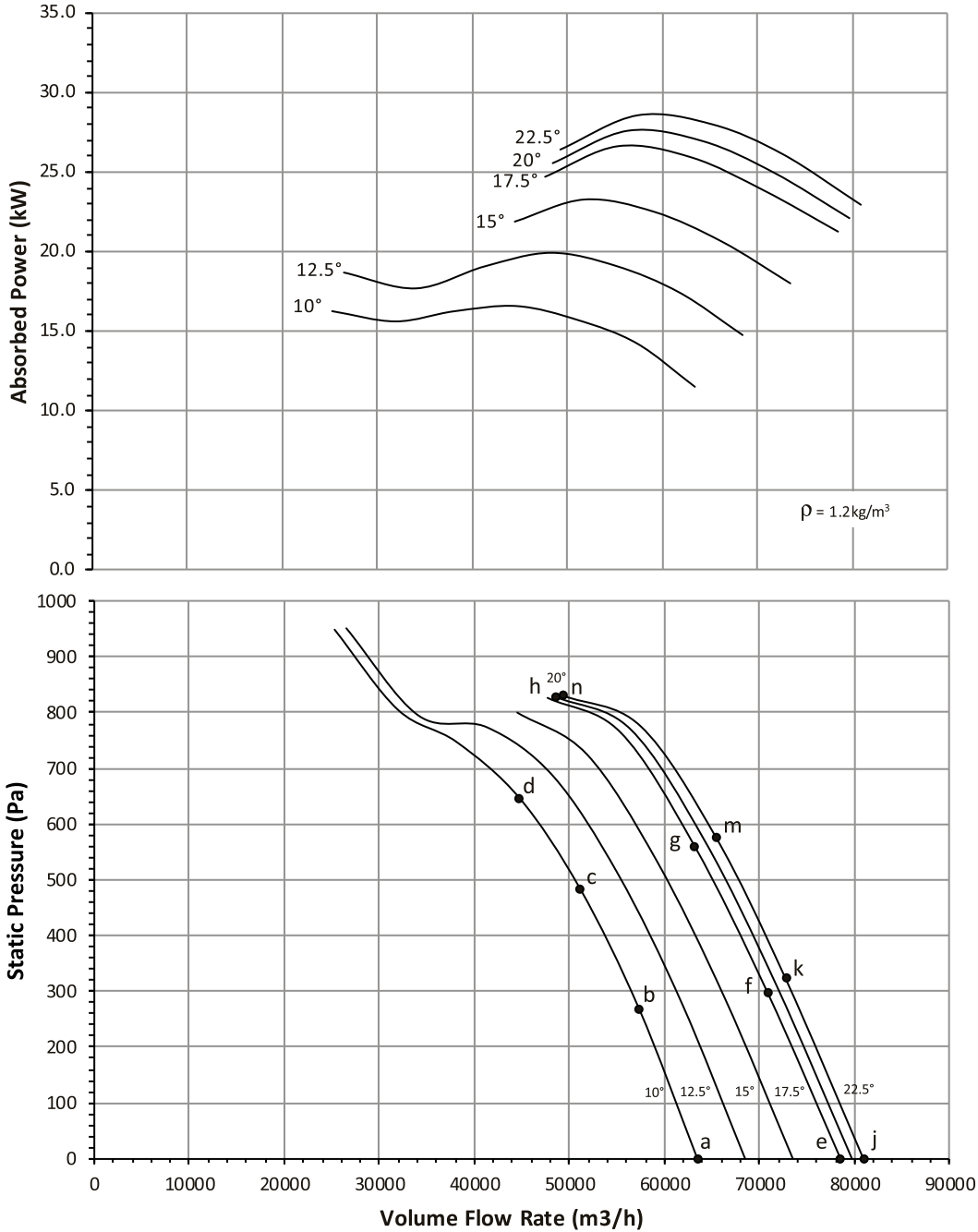

Ref	Full Octave Band Center Frequency								L _{WA}
	63	125	250	500	1K	2K	4K	8K	
a	99	95	100	100	98	94	92	91	103
b	99	96	99	100	98	95	94	90	103
c	99	97	101	105	103	100	97	92	108
d	101	101	109	109	109	104	98	92	112
e	100	98	102	102	100	96	94	90	105
f	100	98	102	102	99	95	94	90	104
g	101	99	103	103	101	98	96	93	106
h	103	106	116	113	109	105	100	94	115
j	100	98	102	102	100	96	94	90	105
k	101	99	103	103	99	96	95	90	105
m	101	99	103	103	101	99	96	93	106
n	103	106	116	113	108	104	99	94	114



Performance certified is for Installation type D: Ducted Inlet- Ducted Outlet. Performance ratings do not include the effects of appurtenances (accessories). Power rating kW is fan input power. The Sound Power Level ratings shown are in decibels, referred to 10⁻¹² watts, calculated per AMCA International Standard 301. Values shown are for inlet L_{WA} and L_{WA} sound power levels for Installation type D: Ducted Inlet-Ducted Outlet. Ratings include the effects of duct end correction. The A-weighted sound ratings shown have been calculated per AMCA International Standard 301.

Performance Curve
FEG 71

ADTA 1120-400-08
ADTA-F 1120-400-08

60Hz 1728rpm
Outlet Area: 0.985 m²

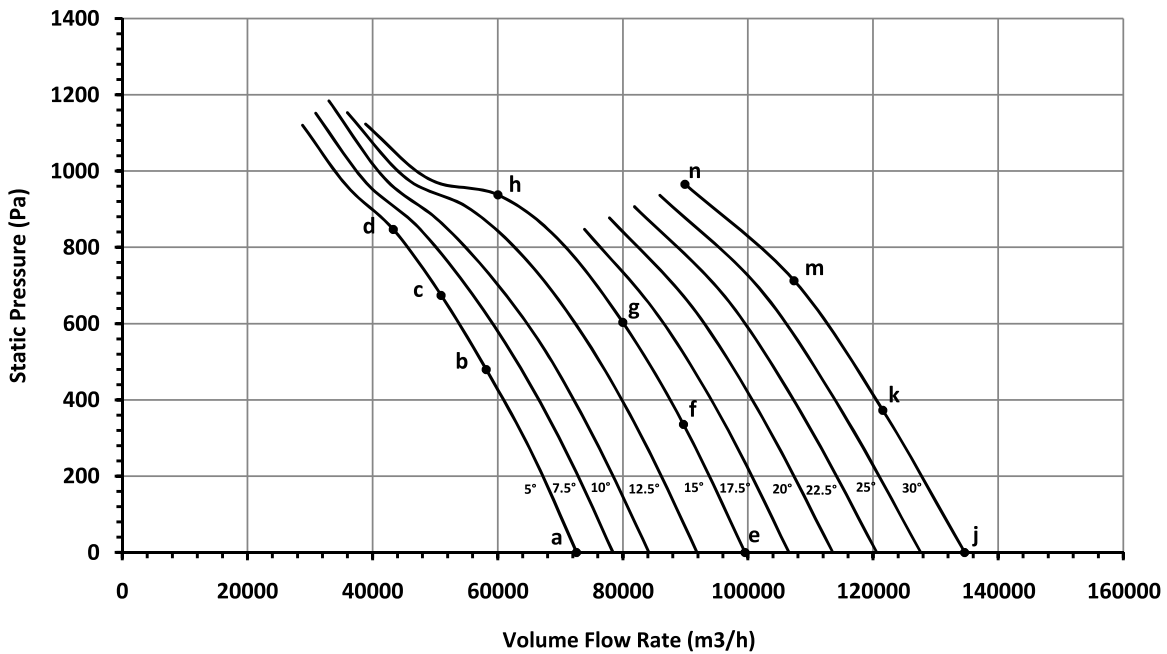
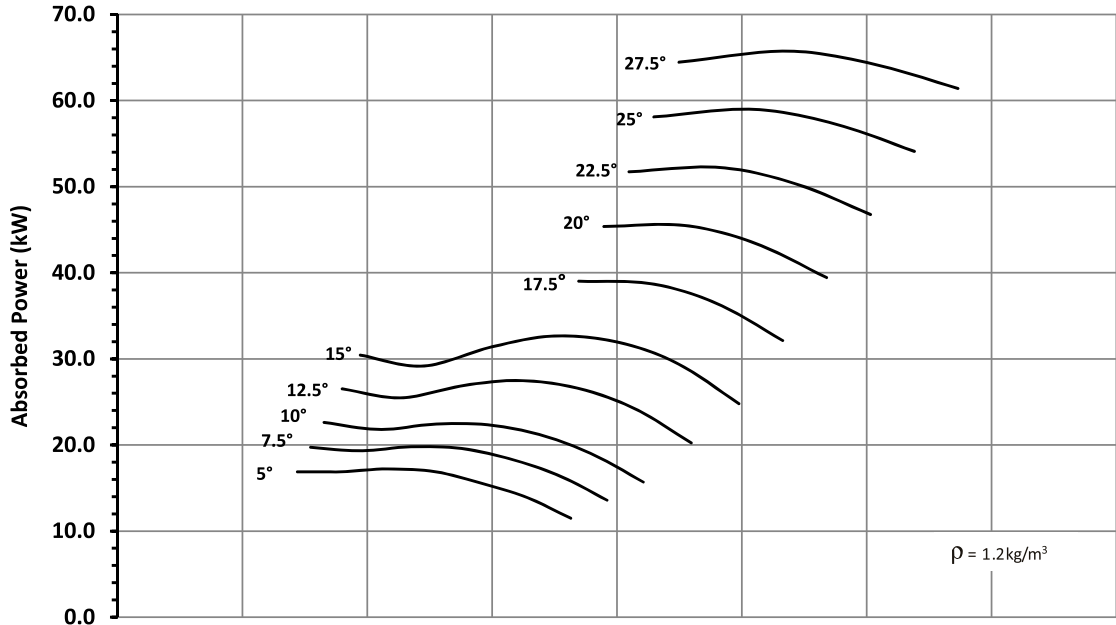

Ref	Full Octave Band Center Frequency								L _{wc} A dB(A)
	63	125	250	500	1K	2K	4K	8K	
a	103	96	99	102	101	98	96	95	106
b	99	95	102	107	109	107	102	96	113
c	100	99	109	109	109	105	100	94	113
d	102	104	111	110	108	103	98	93	112
e	108	101	105	103	102	98	95	93	106
f	106	99	104	102	101	98	97	93	106
g	108	102	106	106	106	103	101	97	110
h	110	115	116	112	109	105	101	95	115
j	114	113	108	106	106	102	99	97	110
k	117	116	109	106	106	103	100	98	111
m	114	113	109	105	105	103	100	99	111
n	112	112	114	111	109	107	102	98	114



Performance certified is for Installation type D: Ducted Inlet- Ducted Outlet. Performance ratings do not include the effects of appurtenances (accessories). Power rating kW is fan input power. The Sound Power Level ratings shown are in decibels, referred to 10⁻¹² watts, calculated per AMCA International Standard 301. Values shown are for outlet L_{w0} and L_{wA} sound power levels for Installation type D: Ducted Inlet-Ducted Outlet. Ratings include the effects of duct end correction. The A-weighted sound ratings shown have been calculated per AMCA International Standard 301.

4 Pole - 1728 rpm

Performance Curve FEG 75

ADTA 1250-400-08
ADTA-F 1250-400-08

60Hz 1728 rpm

Outlet Area: 1.227 m²

4 Pole - 1728 rpm

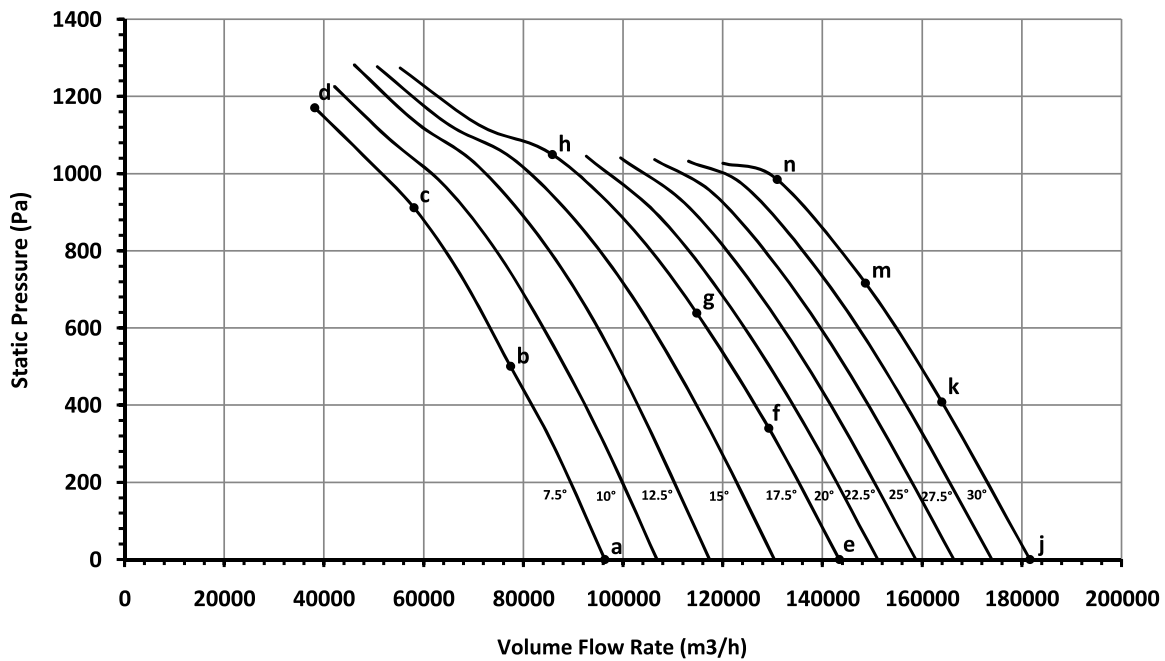
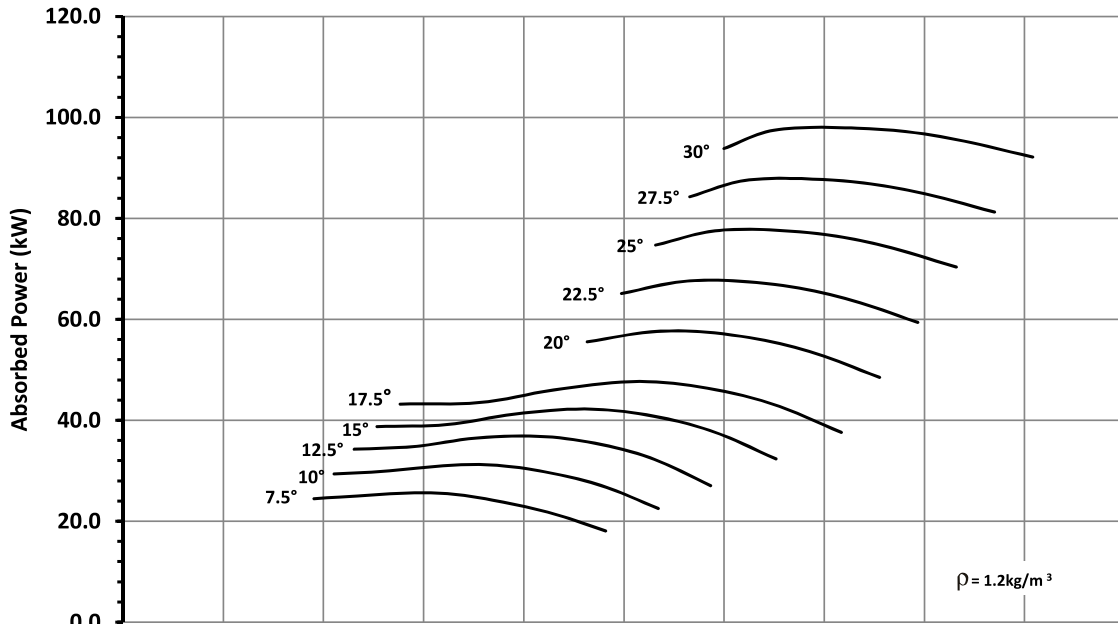

Ref	Full Octave Band Center Frequency								L _{W0} A
	Hz								
	63	125	250	500	1K	2K	4K	8K	
a	106	98	102	105	105	102	99	99	110
b	103	98	106	110	112	109	104	98	115
c	101	105	114	113	111	106	102	96	115
d	105	115	111	109	105	102	99	96	111
e	110	105	109	107	106	102	99	98	110
f	106	102	109	107	107	104	101	99	111
g	109	106	112	112	112	109	105	101	116
h	109	110	121	117	114	110	105	100	119
j	122	121	114	109	109	106	102	99	114
k	121	120	113	109	109	106	103	100	114
m	118	118	113	109	108	107	104	101	114
n	116	116	117	116	115	111	106	102	119



Performance certified is for Installation type D: Ducted Inlet- Ducted Outlet. Performance ratings do not include the effects of appurtenances (accessories) Power rating kW is fan input power. The Sound Power Level ratings shown are in decibels, referred to 10⁻¹² watts, calculated per AMCA International Standard 301. Values shown are for outlet L_{W0} and L_{W0}A sound power levels for Installation type D: Ducted Inlet-Ducted Outlet. Ratings include the effects of duct end correction. The A-weighted sound ratings shown have been calculated per AMCA International Standard 301.

Performance Curve
FEG 75

ADTA 1250-400-12
ADTA-F 1250-400-12

60Hz 1728rpm

Outlet Area: 1.227 m²

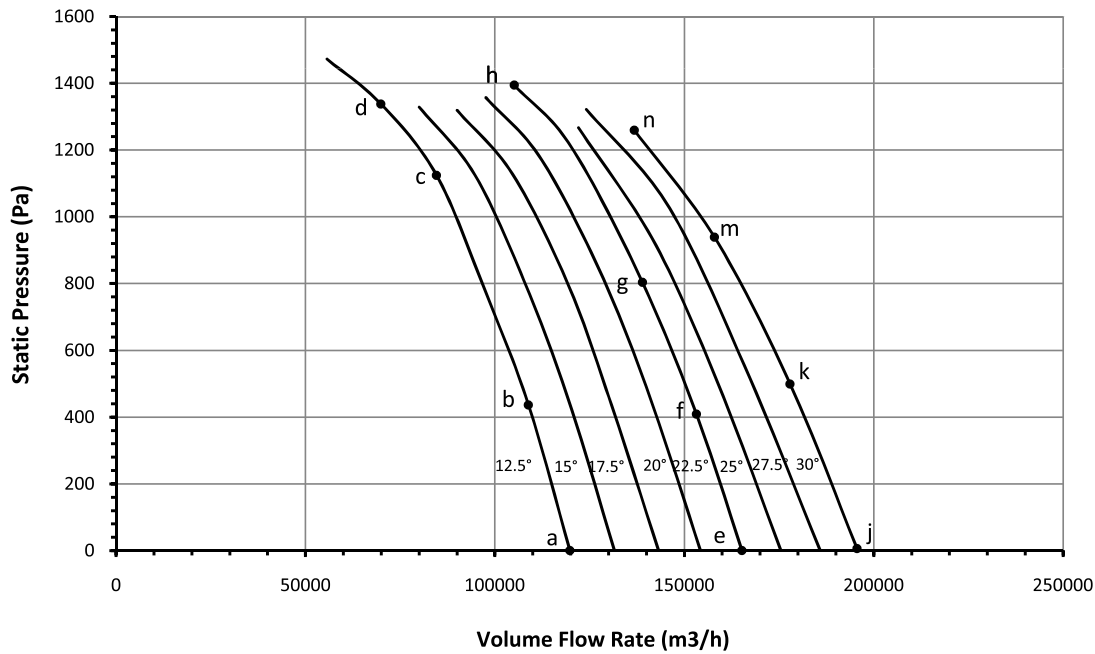
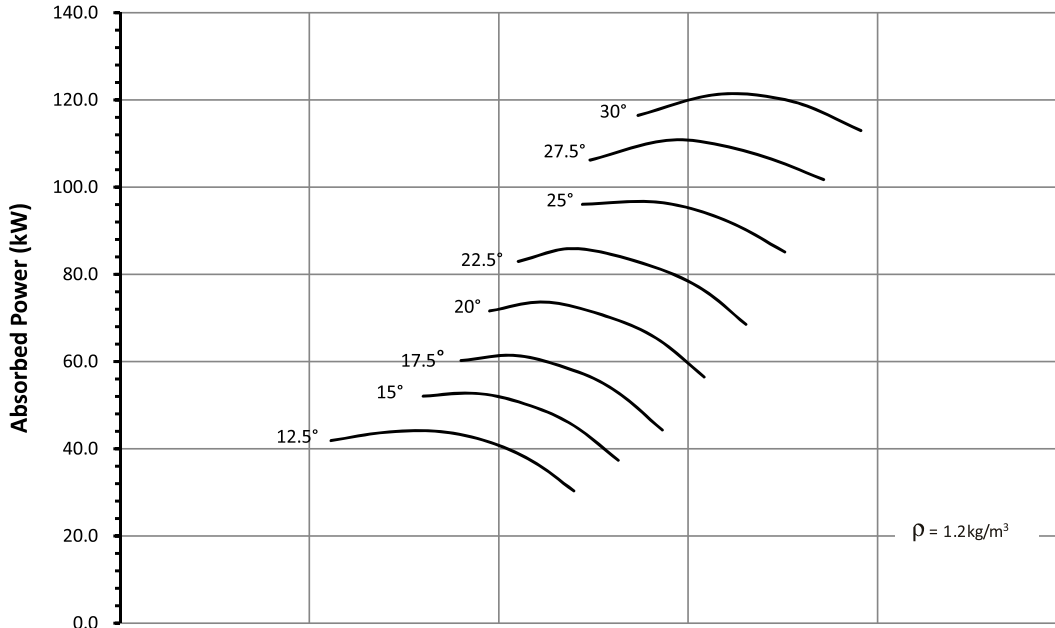

Ref	Full Octave Band Center Frequency								L _w /A dB(A)
	63	125	250	500	1K	2K	4K	8K	
a	109	108	109	108	106	105	103	102	112
b	108	107	108	107	106	107	105	102	115
c	105	105	117	117	113	110	105	99	118
d	110	110	121	120	112	109	104	99	120
e	115	114	111	110	107	105	102	100	113
f	116	114	110	109	107	105	102	100	113
g	112	111	110	109	108	107	104	101	114
h	111	112	118	117	115	112	107	102	120
j	117	115	111	111	108	107	103	100	114
k	118	117	111	111	109	107	104	101	114
m	114	113	112	112	111	109	106	103	116
n	114	116	121	117	116	114	109	104	121



Performance certified is for Installation type D: Ducted Inlet- Ducted Outlet. Performance ratings do not include the effects of appurtenances (accessories) Power rating kW is fan input power. The Sound Power Level ratings shown are in decibels, referred to 10-12 watts, calculated per AMCA International Standard 301. Values shown are for outlet L_w and L_wA sound power levels for Installation type D: Ducted Inlet-Ducted Outlet. Ratings include the effects of duct end correction. The A-weighted sound ratings shown have been calculated per AMCA International Standard 301.

4 Pole - 1728 rpm

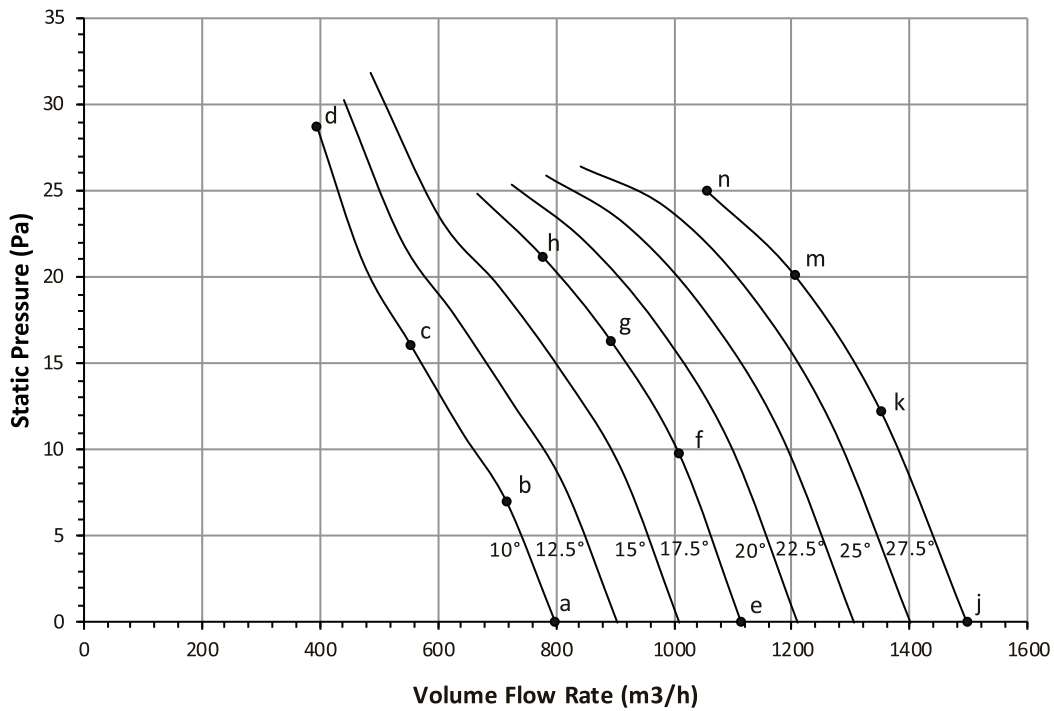
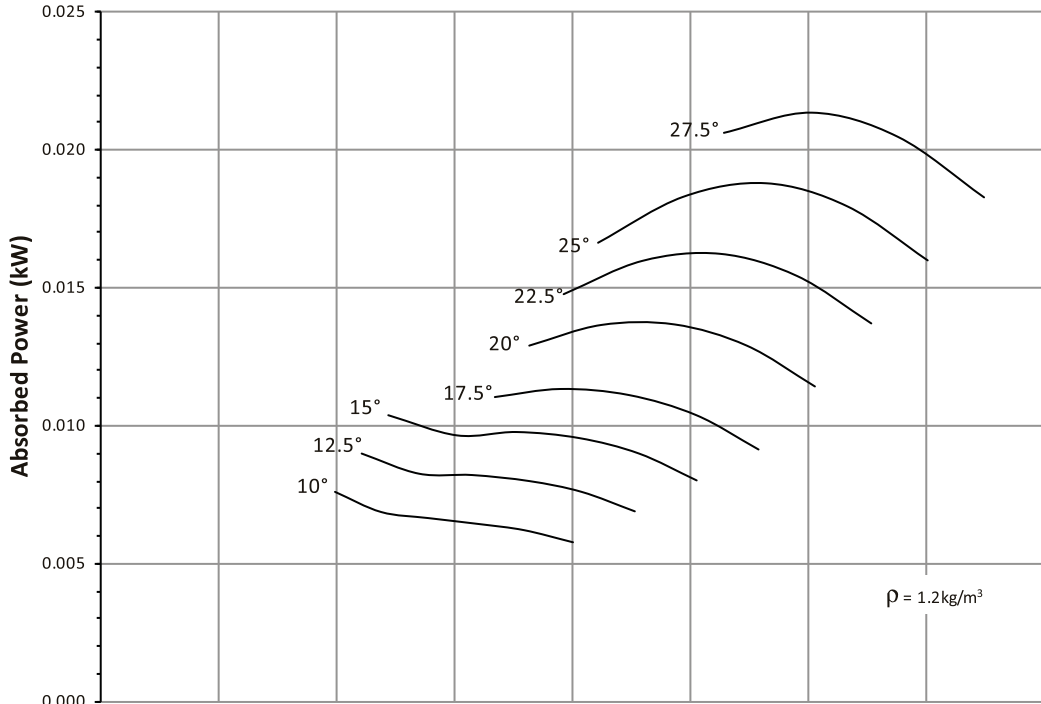

6 Pole - 1152 rpm

Ref	Full Octave Band Center Frequency								L _{WA} dB(A)
	63	125	250	500	1K	2K	4K	8K	
a	61	58	57	57	54	51	48	45	59
b	60	57	57	58	55	51	47	43	60
c	63	65	67	63	57	51	46	41	64
d	68	68	60	57	52	49	45	41	59
e	61	60	54	56	54	52	48	44	59
f	61	57	55	56	53	52	49	46	59
g	62	60	61	60	56	53	50	47	62
h	65	67	67	64	59	53	48	43	65
j	60	58	56	57	53	52	49	46	60
k	64	58	56	57	53	52	49	45	60
m	64	60	108	59	55	53	52	51	61
n	66	64	61	60	55	53	52	51	62



Performance certified for Installation type D: Ducted Inlet- Ducted Outlet. Performance ratings do not include the effects of appurtenances (accessories)
Power rating kW is fan input power.
The Sound Power Level ratings shown are in decibels, referred to 10⁻¹² watts, calculated per AMCA International Standard 301. Values shown are for inlet L_{WA} and L_{WA} sound power levels for Installation type D: Ducted Inlet-Ducted Outlet. Ratings include the effects of duct end correction.
The A-weighted sound ratings shown have been calculated per AMCA International Standard 301.

Performance Curve FEG 67

ADTA 400-160-10
ADTA-F 400-160-10

60Hz 1152 rpm

Outlet Area: 0.129 m²

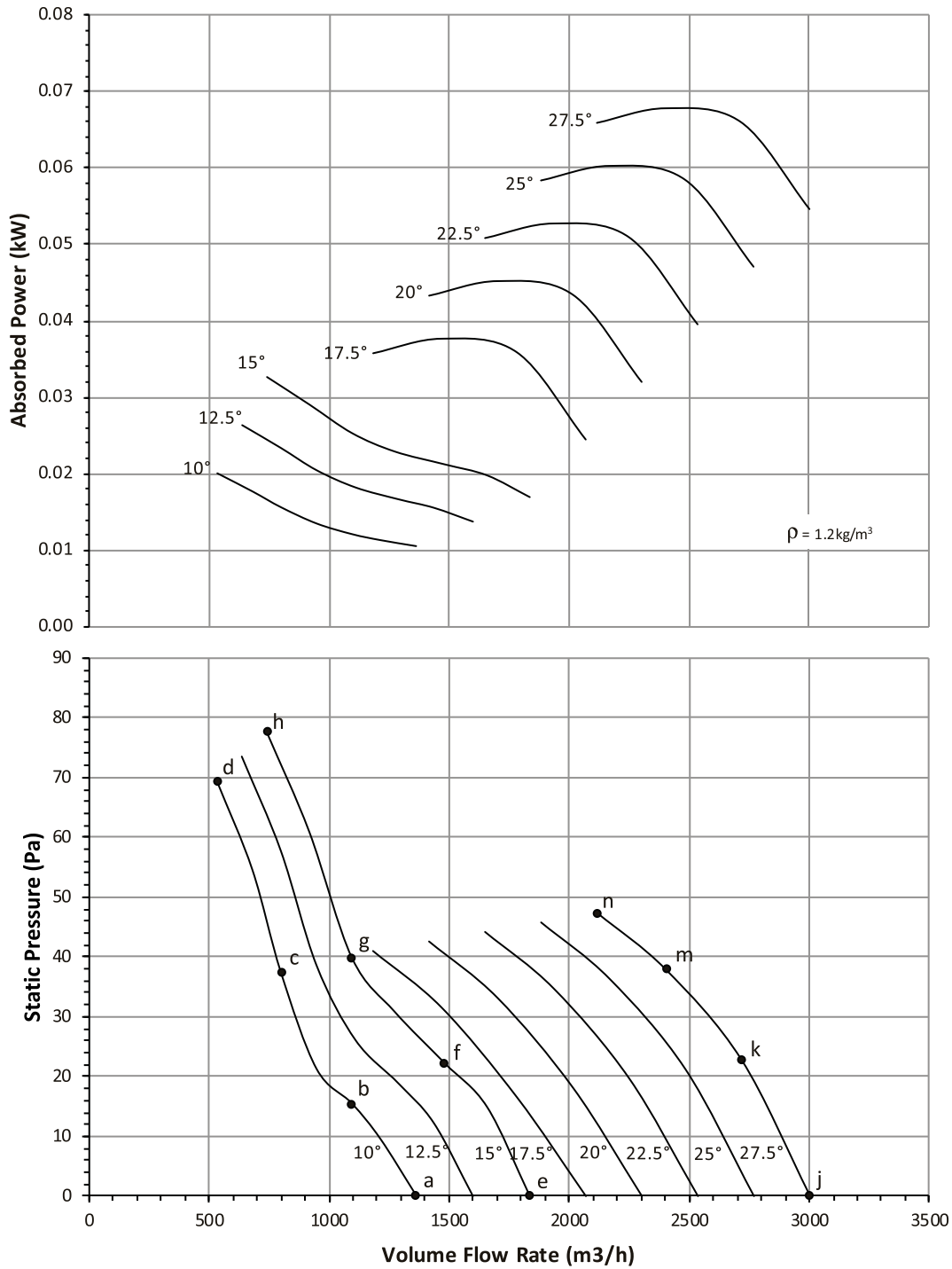

Ref	Full Octave Band Center Frequency								L _w /A
	63	125	250	500	1K	2K	4K	8K	
a	72	72	75	68	65	61	55	48	71
b	74	75	79	70	66	59	53	46	73
c	76	75	74	65	62	57	51	43	69
d	75	73	73	65	62	57	51	43	69
e	72	73	77	66	64	61	55	49	71
f	74	76	79	70	66	61	53	45	74
g	79	81	81	68	64	58	51	43	74
h	75	72	71	64	61	56	50	45	67
j	72	69	70	66	65	63	58	53	70
k	73	69	70	66	65	63	58	52	70
m	75	74	73	68	66	63	58	52	71
n	79	81	77	71	69	64	57	49	75



Performance certified for Installation type D: Ducted Inlet- Ducted Outlet. Performance ratings do not include the effects of appurtenances (accessories) Power rating kW is fan input power. The Sound Power Level ratings shown are in decibels, referred to 10⁻¹² watts, calculated per AMCA International Standard 301. Values shown are for inlet L_w and L_w/A sound power levels for Installation type D: Ducted Inlet-Ducted Outlet. Ratings include the effects of duct end correction. The A-weighted sound ratings shown have been calculated per AMCA International Standard 301.

6 Pole - 1152 rpm

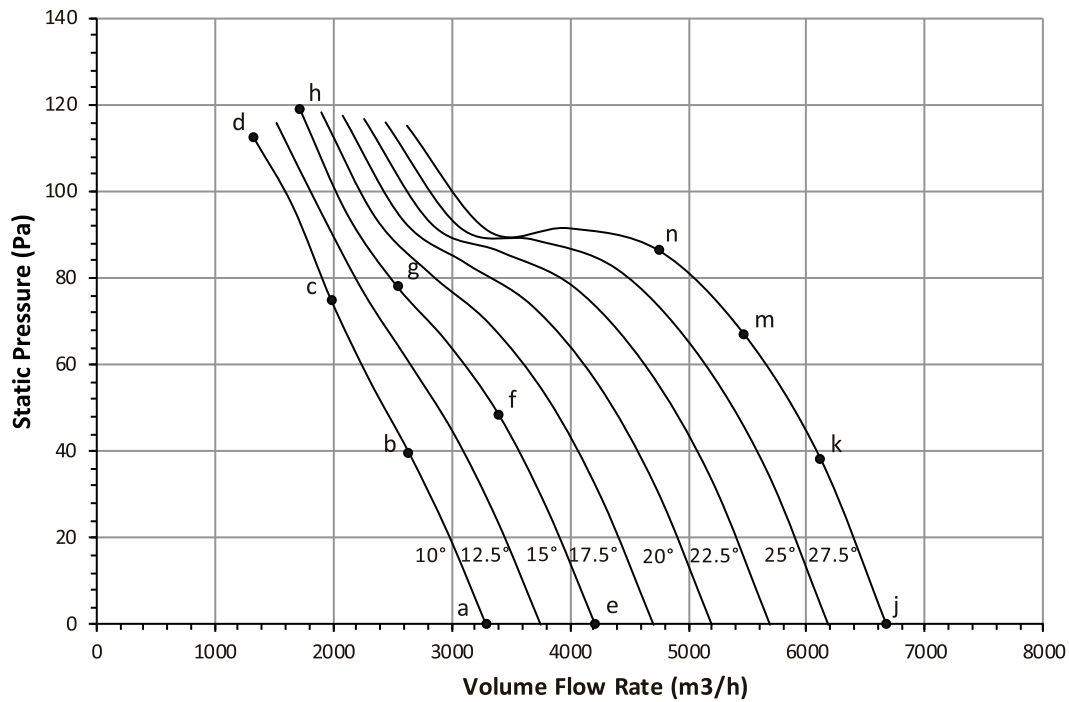
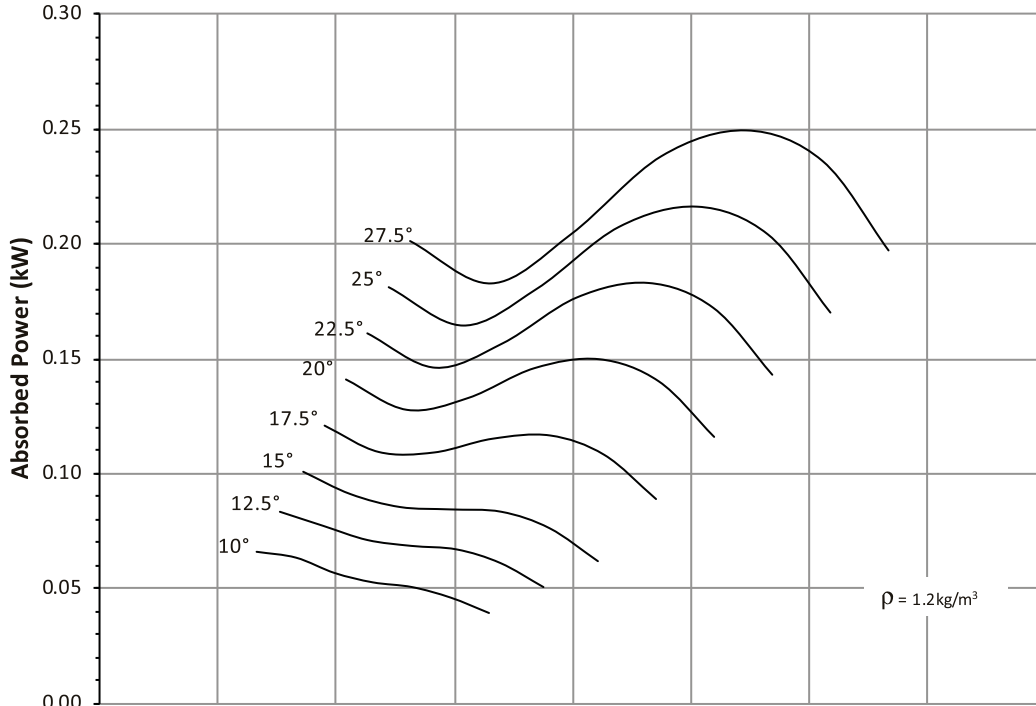

6 Pole - 1152 rpm

Ref	Full Octave Band Center Frequency								L _w A
	63	125	250	500	1K	2K	4K	8K	
a	78	77	80	75	73	70	64	56	78
b	79	77	80	77	74	68	61	53	79
c	86	88	87	75	71	66	58	50	81
d	83	84	81	70	67	65	58	49	76
e	76	74	80	73	72	70	65	58	78
f	77	77	79	77	75	70	64	56	79
g	91	96	87	77	72	67	60	52	83
h	85	83	79	71	68	65	59	51	75
j	75	72	81	75	71	70	67	61	78
k	76	72	76	77	71	69	66	59	78
m	80	78	80	79	74	70	66	59	80
n	87	84	82	77	73	69	64	57	80



Performance certified is for Installation type D: Ducted Inlet- Ducted Outlet. Performance ratings do not include the effects of appurtenances (accessories) Power rating kW is fan input power. The Sound Power Level ratings shown are in decibels, referred to 10⁻¹² watts, calculated per AMCA International Standard 301. Values shown are for inlet L_w and L_wA sound power levels for Installation type D: Ducted Inlet-Ducted Outlet. Ratings include the effects of duct end correction. The A-weighted sound ratings shown have been calculated per AMCA International Standard 301.

Performance Curve FEG 67

ADTA 560-160-10
ADTA-F 560-160-10

60Hz 1152 rpm

Outlet Area: 0.248 m²

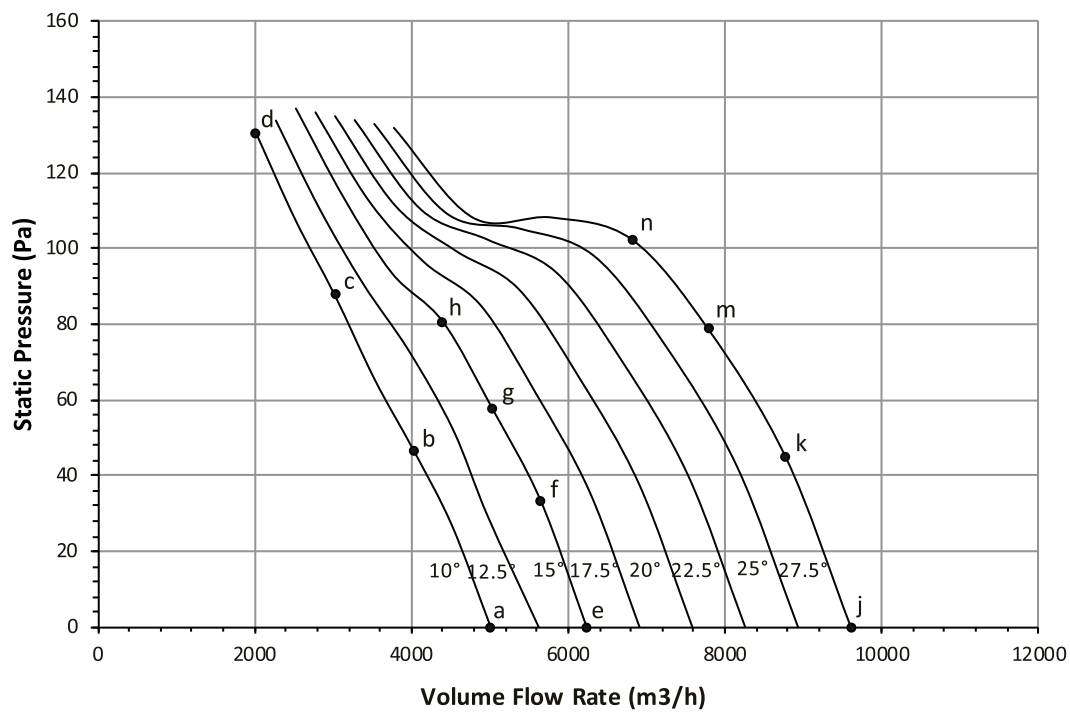
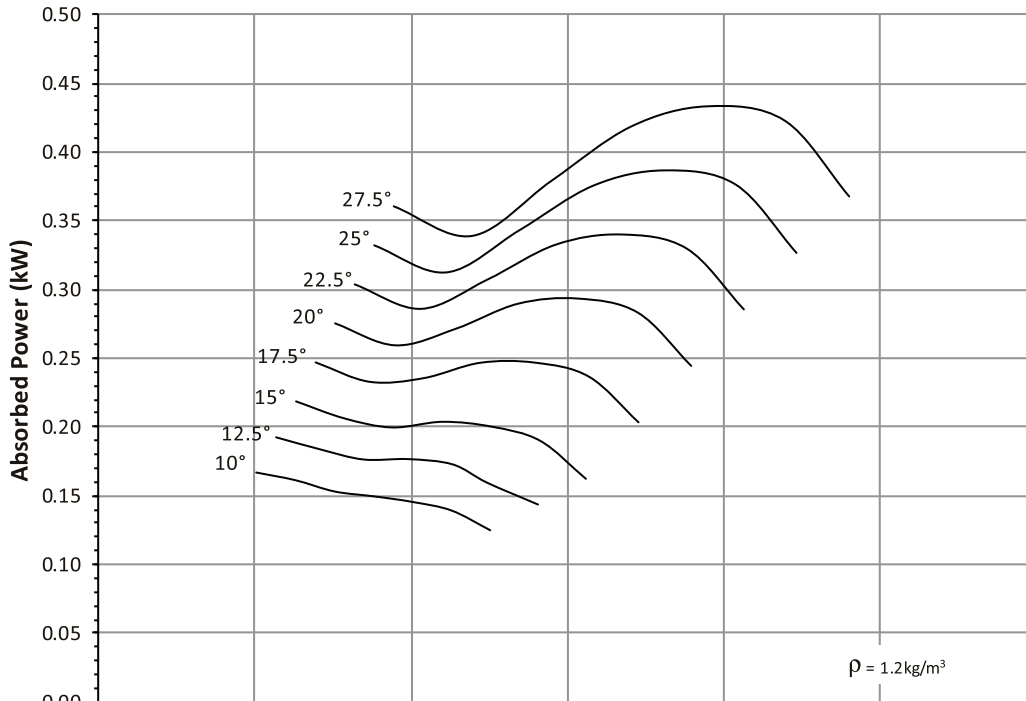

Ref	Full Octave Band Center Frequency								L _{WA} dB(A)
	63	125	250	500	1K	2K	4K	8K	
a	77	73	75	76	75	73	68	61	80
b	80	77	76	80	78	73	66	59	82
c	87	85	84	79	75	71	64	55	81
d	87	83	77	72	71	68	63	55	76
e	77	71	74	75	75	73	69	63	79
f	75	70	72	74	74	73	69	63	79
g	80	77	77	80	79	75	69	62	83
h	83	81	80	81	78	73	66	58	83
j	78	72	78	77	75	73	70	64	80
k	79	75	78	78	74	72	70	65	80
m	84	81	82	79	76	74	70	65	82
n	87	87	84	82	79	75	70	64	84



Performance certified is for Installation type D: Ducted Inlet- Ducted Outlet. Performance ratings do not include the effects of appurtenances (accessories) Power rating kW is fan input power. The Sound Power Level ratings shown are in decibels, referred to 10⁻¹² watts, calculated per AMCA International Standard 301. Values shown are for inlet L_w and L_{WA} sound power levels for Installation type D: Ducted Inlet-Ducted Outlet. Ratings include the effects of duct end correction. The A-weighted sound ratings shown have been calculated per AMCA International Standard 301.

6 Pole - 1152 rpm

Performance Curve
FEG 90

ADTA 630-160-05
ADTA-F 630-160-05

60Hz 1152rpm

Outlet Area: 0.312 m²

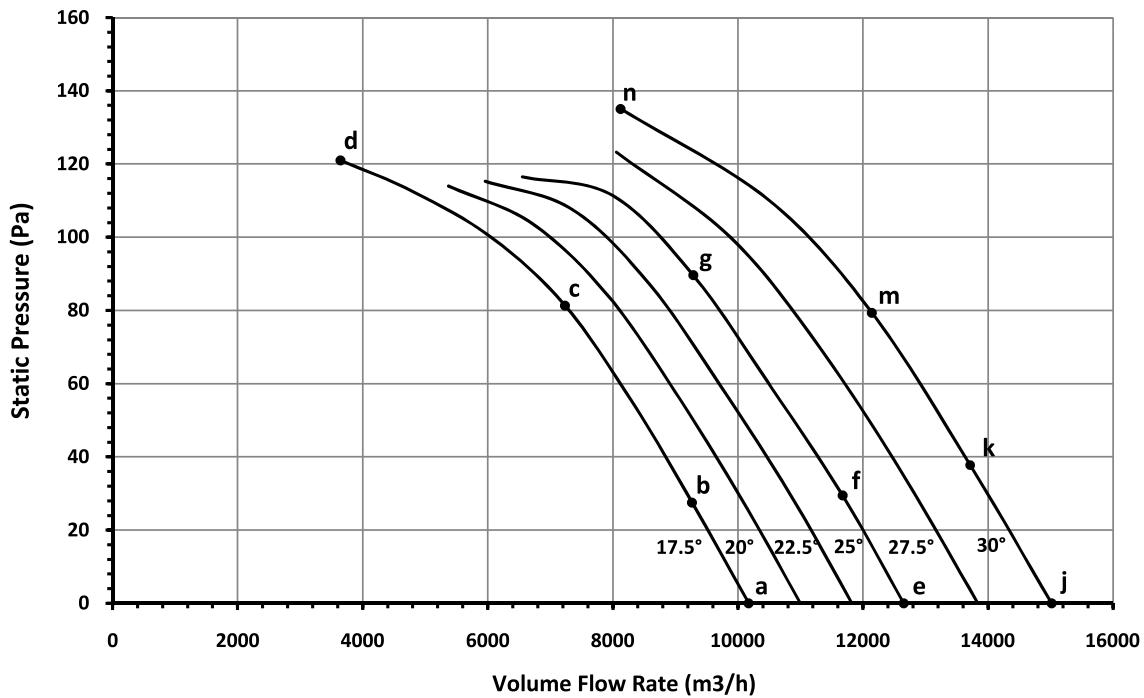
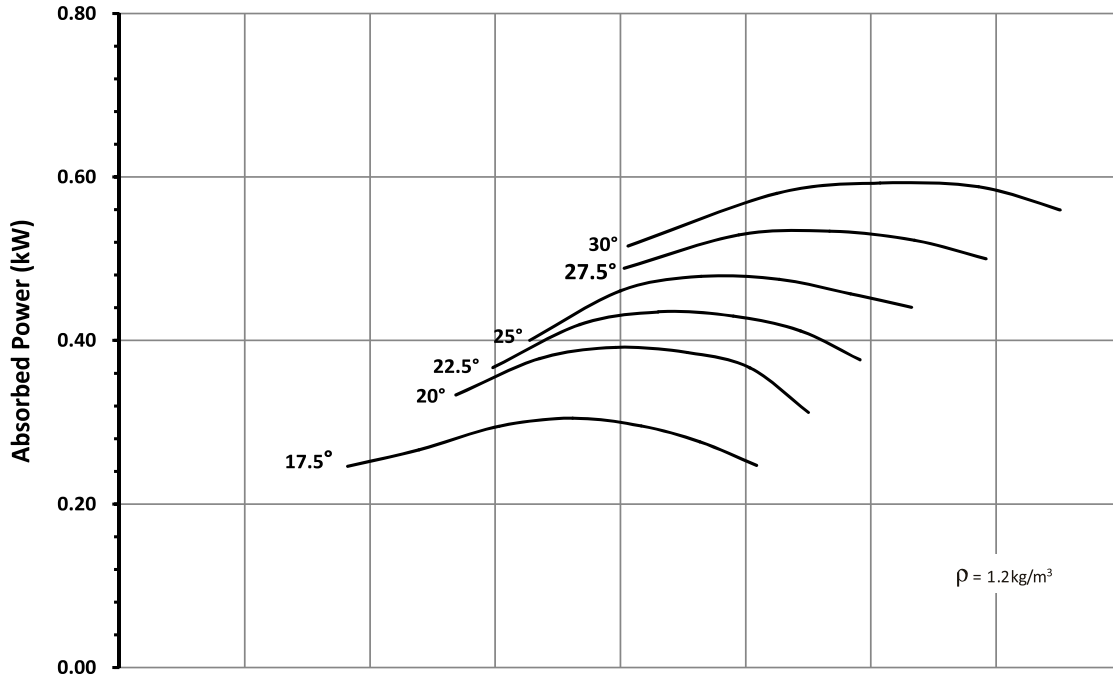

Ref	Full Octave Band Center Frequency								L _{WA} dB(A)
	63	125	250	500	1K	2K	4K	8K	
a	78	73	71	73	72	70	70	68	78
b	76	73	72	73	71	70	69	66	77
c	77	73	74	76	75	73	70	67	80
d	83	80	88	88	81	76	71	65	88
e	80	76	75	75	73	71	70	67	79
f	78	75	75	75	73	71	70	68	79
g	80	75	75	76	73	72	70	67	79
j	82	80	76	77	75	73	71	69	80
k	81	78	75	76	74	73	70	67	80
m	82	79	74	76	75	74	71	68	81
n	95	90	79	77	74	71	68	63	81



Performance certified is for Installation type D: Ducted Inlet- Ducted Outlet. Performance ratings do not include the effects of appurtenances (accessories) Power rating kW is fan input power. The Sound Power Level ratings shown are in decibels, referred to 10⁻¹² watts, calculated per AMCA International Standard 301. Values shown are for inlet L_{WA} and L_{WA} sound power levels for Installation type D: Ducted Inlet-Ducted Outlet. Ratings include the effects of duct end correction. The A-weighted sound ratings shown have been calculated per AMCA International Standard 301.

6 Pole - 1152 rpm

Performance Curve FEG 60

ADTA 630-230-12
ADTA-F 630-230-12

60Hz 1152 rpm

Outlet Area: 0.312 m²

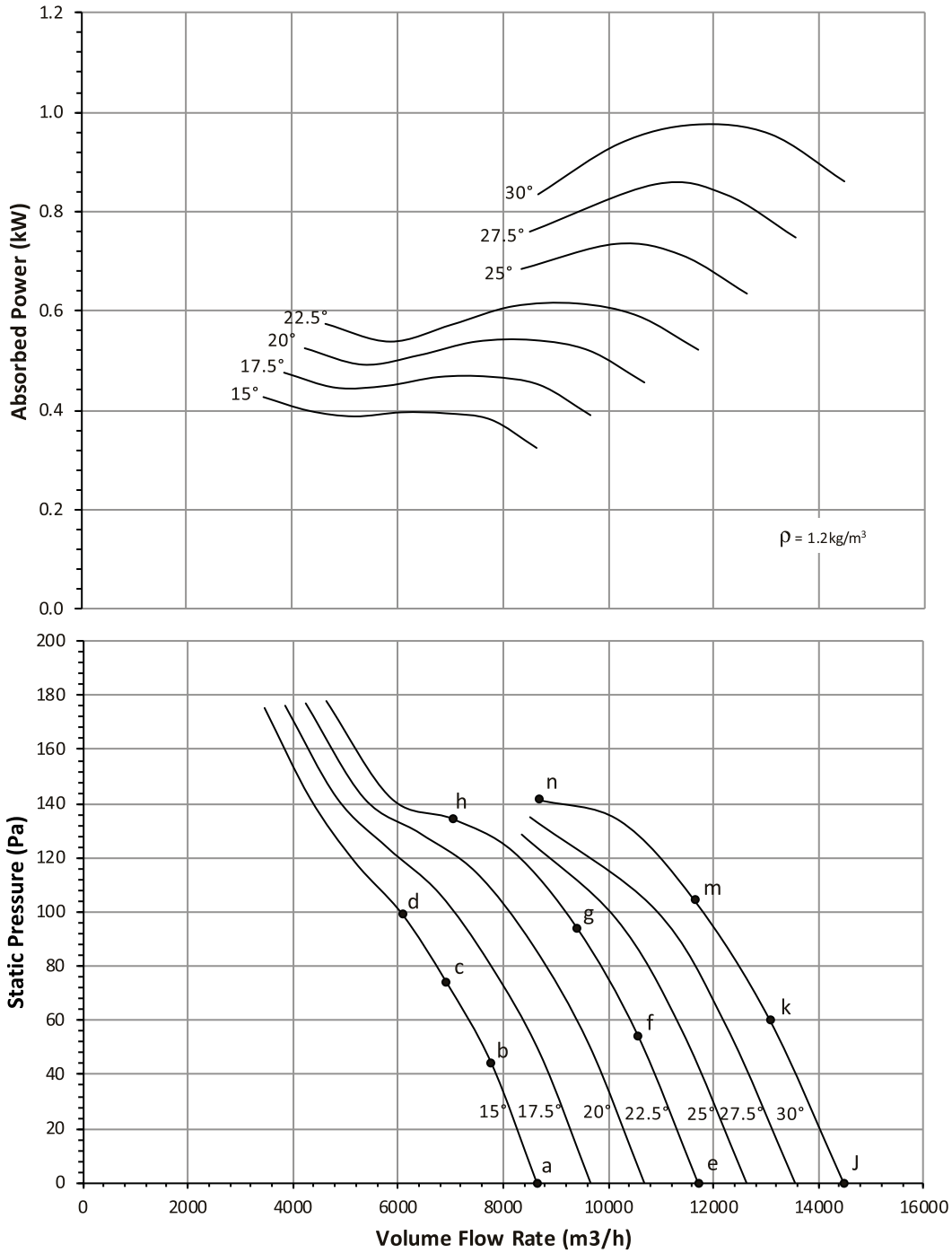

Ref	Full Octave Band Center Frequency								L _w A dB(A)
	63	125	250	500	1K	2K	4K	8K	
a	79	74	76	78	78	77	75	70	83
b	79	73	75	77	78	76	74	69	83
c	81	77	82	83	83	79	73	67	86
d	83	82	88	86	83	78	72	64	88
e	81	74	76	77	76	76	75	70	82
f	82	75	77	77	76	75	74	69	82
g	84	80	83	80	80	78	74	69	85
h	87	88	93	87	84	78	72	65	90
j	82	75	79	79	77	76	75	71	83
k	83	77	79	79	77	76	74	70	83
m	85	81	83	82	80	77	74	69	85
n	93	93	90	87	84	79	73	66	89



Performance certified for Installation type D: Ducted Inlet- Ducted Outlet. Performance ratings do not include the effects of appurtenances (accessories)
Power rating kW is fan input power.
The Sound Power Level ratings shown are in decibels, referred to 10⁻¹² watts, calculated per AMCA International Standard 301. Values shown are for inlet L_w and L_wA sound power levels for Installation type D: Ducted Inlet-Ducted Outlet. Ratings include the effects of duct end correction.
The A-weighted sound ratings shown have been calculated per AMCA International Standard 301.

6 Pole - 1152 rpm

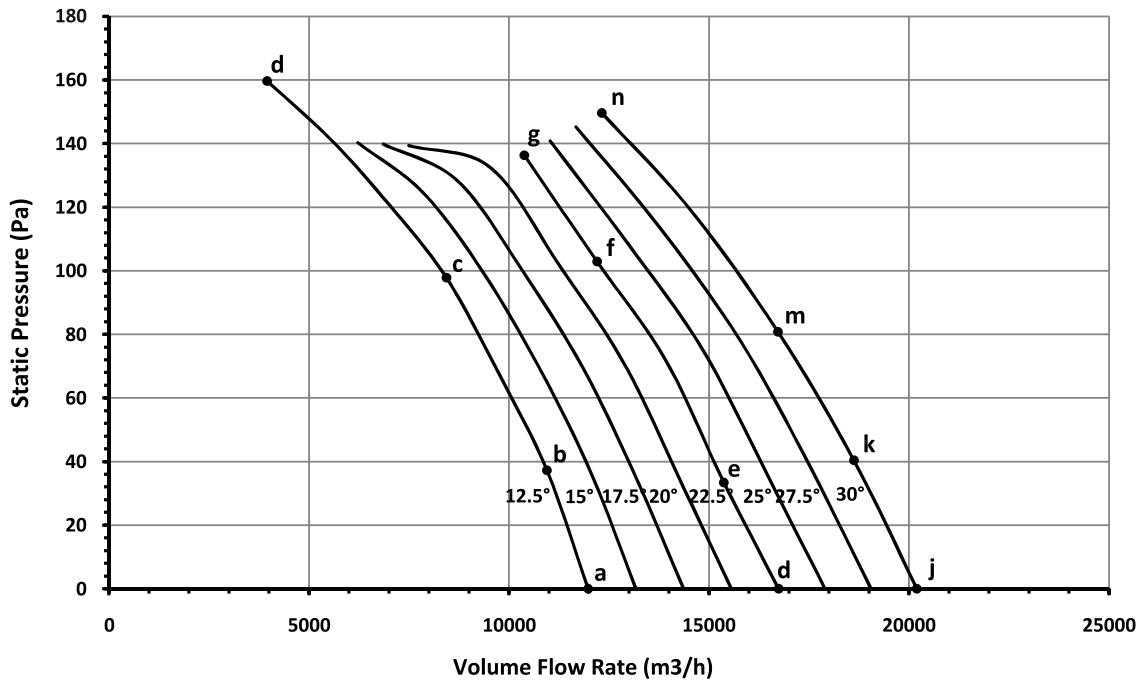
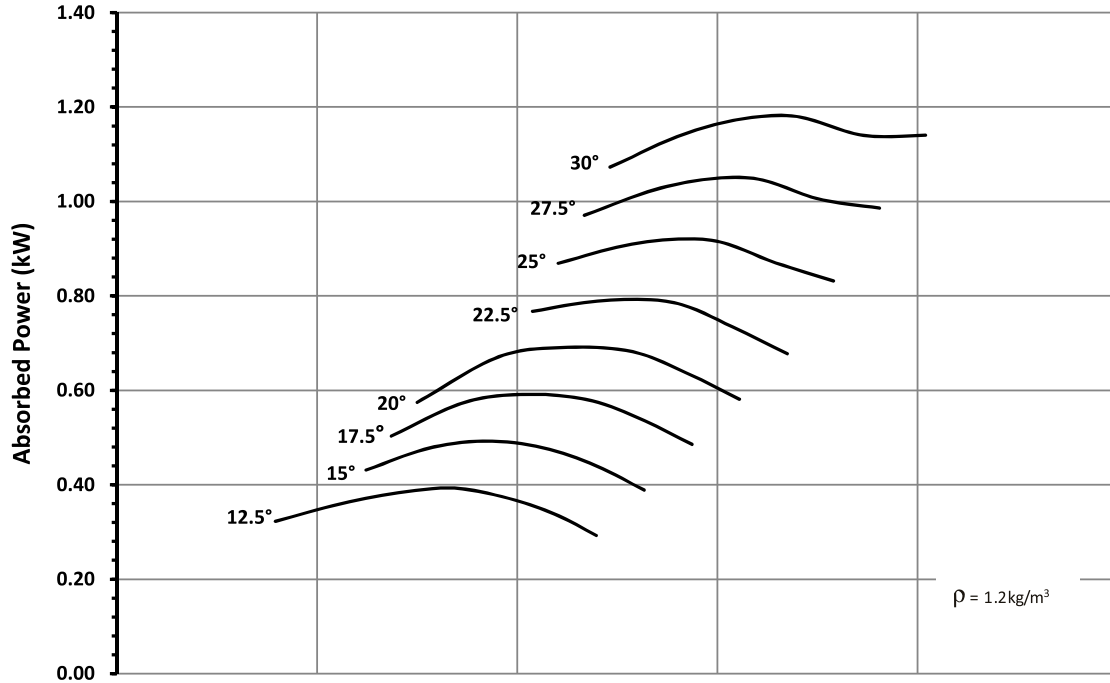

6 Pole - 1152 rpm

Ref	Full Octave Band Center Frequency								L _{WA} dB(A)
	63	125	250	500	1K	2K	4K	8K	
a	74	73	74	75	75	74	74	72	81
b	72	72	73	74	74	72	72	71	80
c	77	74	77	83	83	79	74	70	87
d	79	79	87	90	84	79	73	68	90
e	80	81	82	79	77	75	74	72	83
f	80	81	77	78	77	76	74	71	83
g	79	80	77	78	78	77	74	70	83
h	79	80	77	79	80	78	74	70	84
j	83	82	80	81	80	78	75	72	85
k	82	81	80	80	80	78	75	71	84
m	83	82	79	79	80	78	75	71	84
n	82	82	81	81	81	78	75	72	85



Performance certified is for Installation type D: Ducted Inlet- Ducted Outlet. Performance ratings do not include the effects of appurtenances (accessories). Power rating kW is fan input power. The Sound Power Level ratings shown are in decibels, referred to 10⁻¹² watts, calculated per AMCA International Standard 301. Values shown are for inlet L_{WA} and L_{WA} sound power levels for Installation type D: Ducted Inlet-Ducted Outlet. Ratings include the effects of duct end correction. The A-weighted sound ratings shown have been calculated per AMCA International Standard 301.

Performance Curve
FEG 60

ADTA 710-230-12
ADTA-F 710-230-12

60Hz 1152 rpm

Outlet Area: 0.396 m²

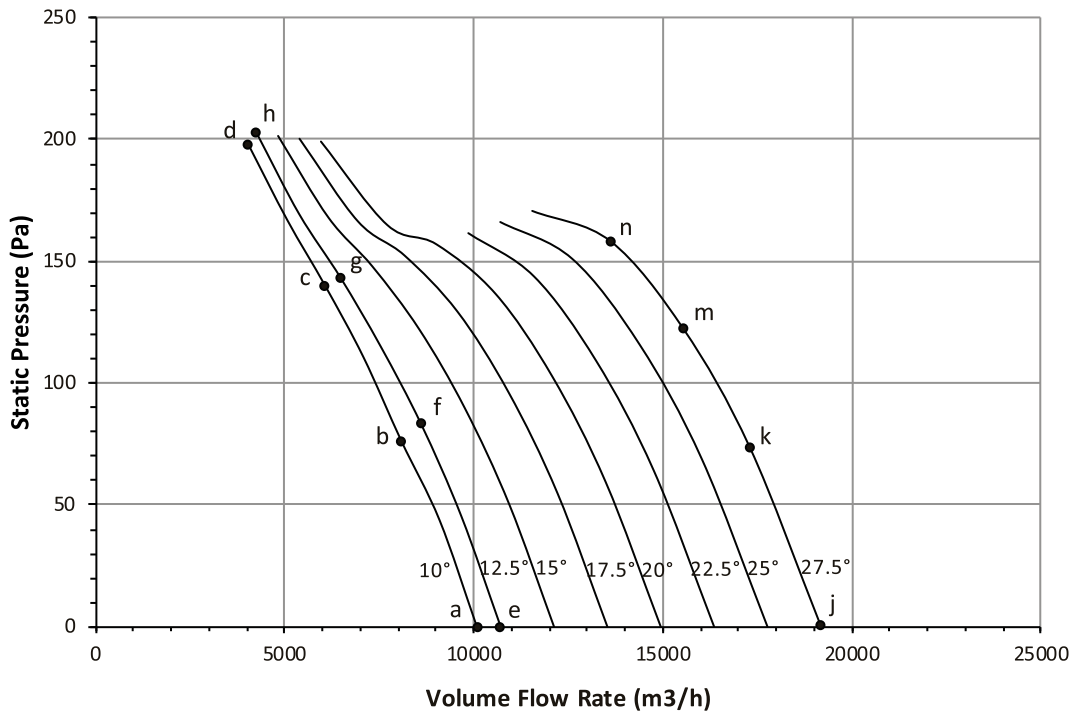
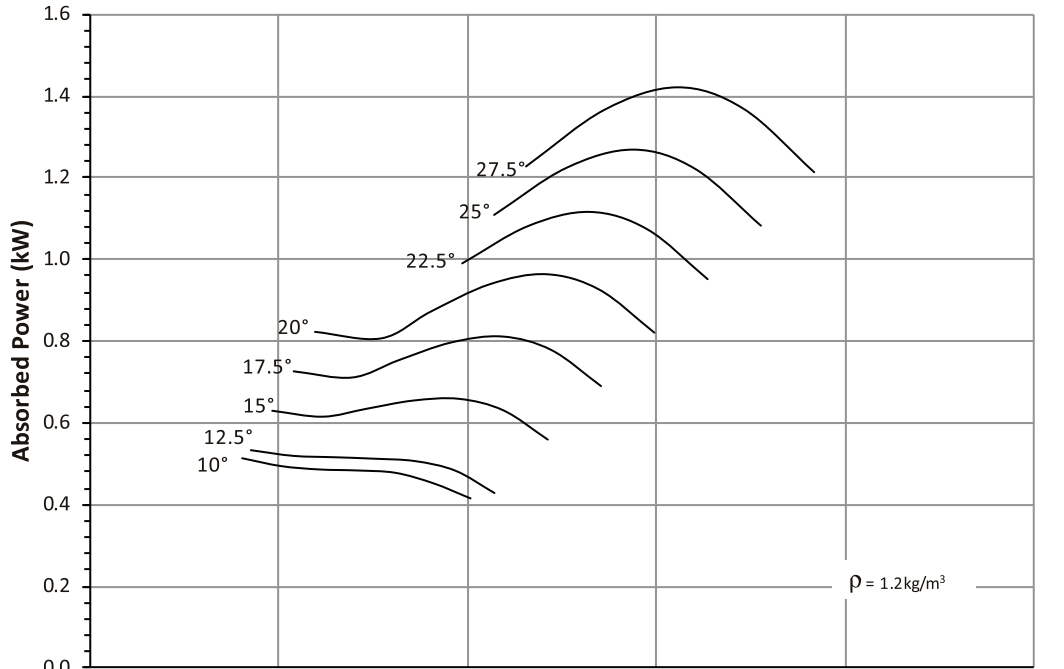

Ref	Full Octave Band Center Frequency								L _w /A dB(A)
	63	125	250	500	1K	2K	4K	8K	
a	81	77	79	81	82	81	77	73	87
b	81	77	82	87	86	82	76	70	90
c	86	84	90	87	84	79	73	66	89
d	88	81	85	79	77	75	71	64	83
e	80	77	79	81	81	80	78	73	86
f	81	77	82	87	86	82	76	70	90
g	86	84	91	87	84	79	73	66	89
h	90	82	85	79	77	75	70	64	83
j	82	78	85	81	80	78	77	74	86
k	84	79	87	83	81	79	78	75	87
m	85	82	88	89	84	82	78	73	90
n	89	89	92	90	88	83	78	71	92



Performance certified is for Installation type D: Ducted Inlet- Ducted Outlet. Performance ratings do not include the effects of appurtenances (accessories) Power rating kW is fan input power. The Sound Power Level ratings shown are in decibels, referred to 10⁻¹² watts, calculated per AMCA International Standard 301. Values shown are for inlet L_w and L_w/A sound power levels for Installation type D: Ducted Inlet-Ducted Outlet. Ratings include the effects of duct end correction. The A-weighted sound ratings shown have been calculated per AMCA International Standard 301.

6 Pole - 1152 rpm

Performance Curve FEG 71

ADTA 710-250-12
ADTA-F 710-250-12

60Hz 1152 rpm

Outlet Area: 0.396 m²

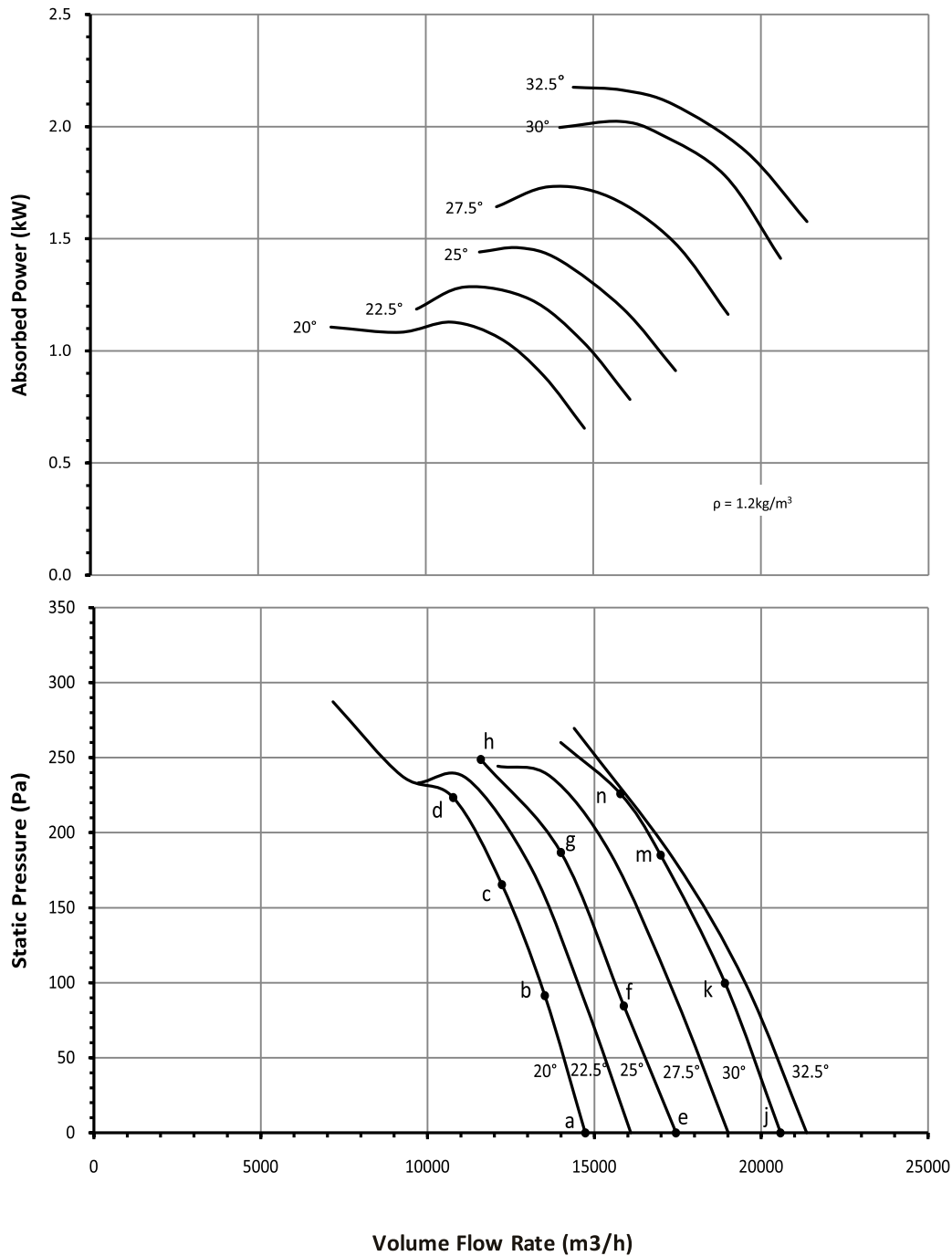

6 Pole - 1152 rpm

Ref	Full Octave Band Center Frequency								L _{Wf} /A dB(A)
	63	125	250	500	1K	2K	4K	8K	
a	82	78	81	80	79	78	74	65	84
b	82	76	80	79	78	77	74	66	83
c	79	77	81	82	80	78	73	66	85
d	82	82	87	90	85	80	74	67	90
e	81	78	81	81	80	78	75	68	85
f	82	78	81	80	79	77	74	70	84
g	82	78	82	81	80	77	73	72	85
h	88	89	90	90	85	80	75	70	91
j	83	80	83	83	81	79	79	81	87
k	84	80	83	81	80	77	75	75	85
m	84	80	84	81	80	76	73	71	84
n	86	85	87	84	81	78	74	71	87



Performance certified is for Installation type D: Ducted Inlet- Ducted Outlet. Performance ratings do not include the effects of appurtenances (accessories)
Power rating kW is fan input power.
The Sound Power Level ratings shown are in decibels, referred to 10-12 watts, calculated per AMCA International Standard 301. Values shown are for inlet LWi and LWiA sound power levels for Installation type D: Ducted Inlet-Ducted Outlet. Ratings include the effects of duct end correction.
The A-weighted sound ratings shown have been calculated per AMCA International Standard 301.

Performance Curve
FEG 71

ADTA 800-250-12
ADTA-F 800-250-12

60Hz 1152 rpm

Outlet Area: 0.503 m²

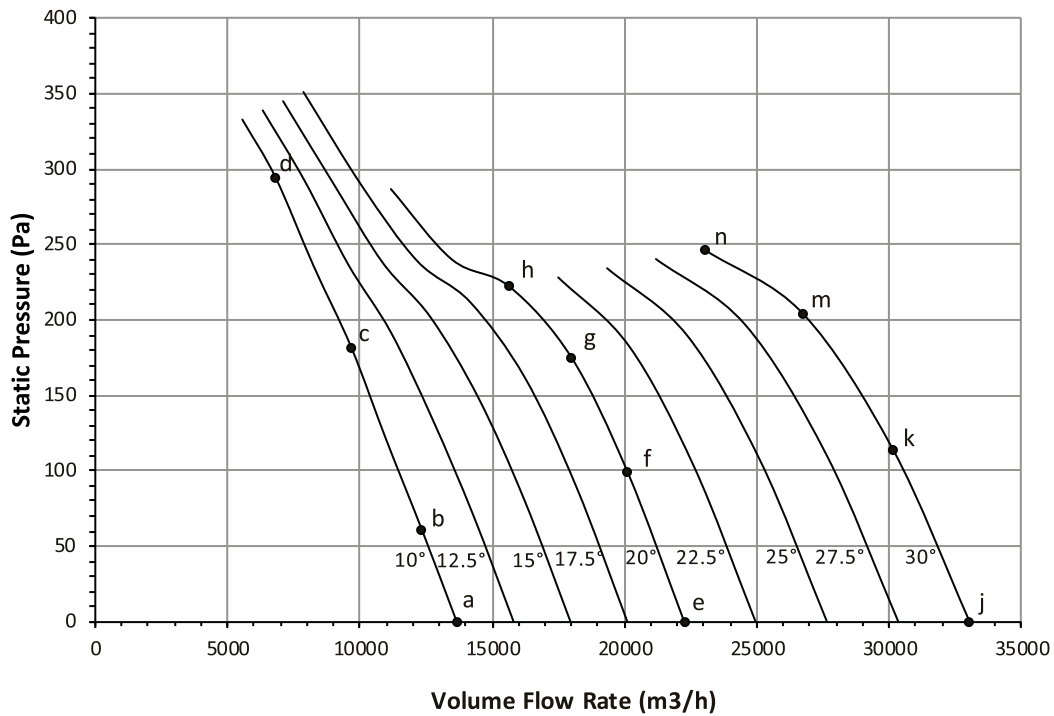
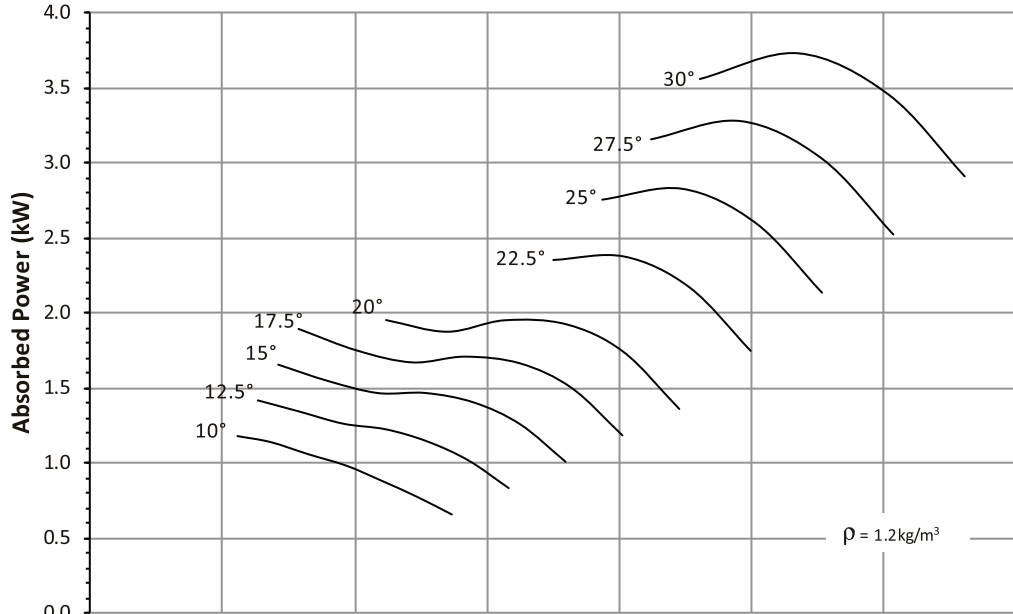

Ref	Full Octave Band Center Frequency								L _{WA} dB(A)
	63	125	250	500	1K	2K	4K	8K	
a	81	80	85	84	84	83	79	65	89
b	81	80	85	87	89	86	79	65	92
c	87	89	94	92	87	82	74	62	93
d	91	90	94	86	83	78	71	62	89
e	82	81	88	84	84	85	81	65	90
f	83	82	88	85	85	85	81	67	90
g	87	87	91	91	90	86	79	69	94
h	92	97	98	93	90	83	75	68	95
j	84	84	89	87	85	84	80	66	91
k	83	83	88	86	86	83	79	71	90
m	86	88	89	88	87	84	79	73	92
n	93	101	94	93	91	86	80	73	96



Performance certified is for Installation type D: Ducted Inlet- Ducted Outlet. Performance ratings do not include the effects of appurtenances (accessories) Power rating kW is fan input power. The Sound Power Level ratings shown are in decibels, referred to 10⁻¹² watts, calculated per AMCA International Standard 301. Values shown are for inlet L_W and L_{WA} sound power levels for Installation type D: Ducted Inlet-Ducted Outlet. Ratings include the effects of duct end correction. The A-weighted sound ratings shown have been calculated per AMCA International Standard 301.

6 Pole - 1152 rpm

Performance Curve FEG 75

ADTA 800-250-12-T
ADTA-F 800-250-12-T

60Hz 1152 rpm

Outlet Area: 0.503 m²

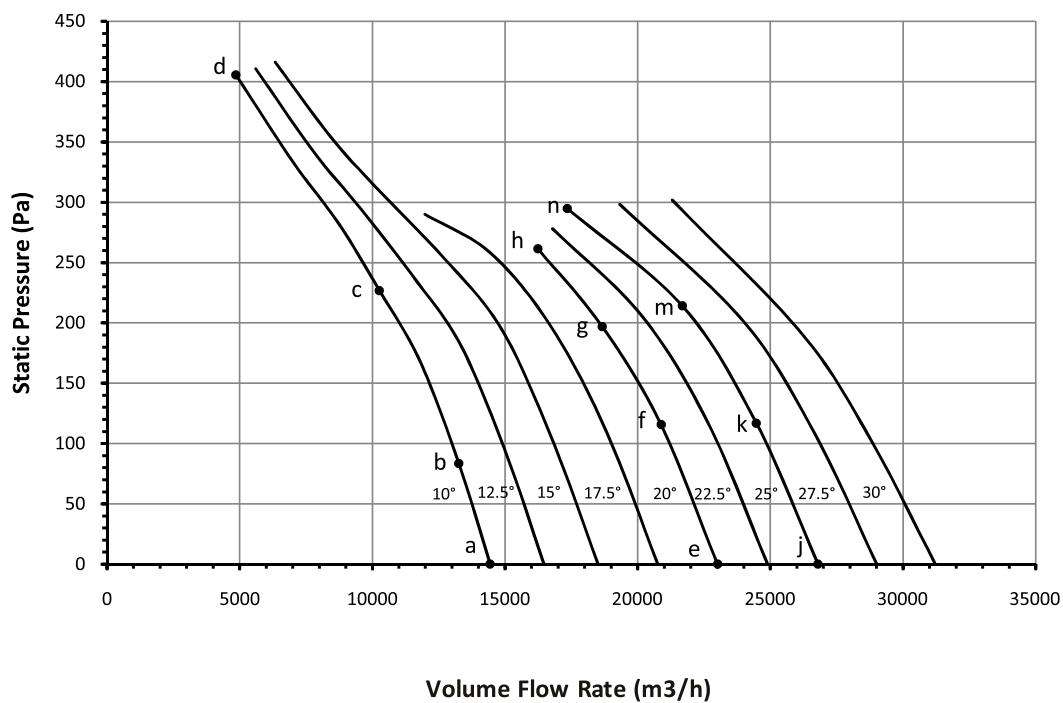
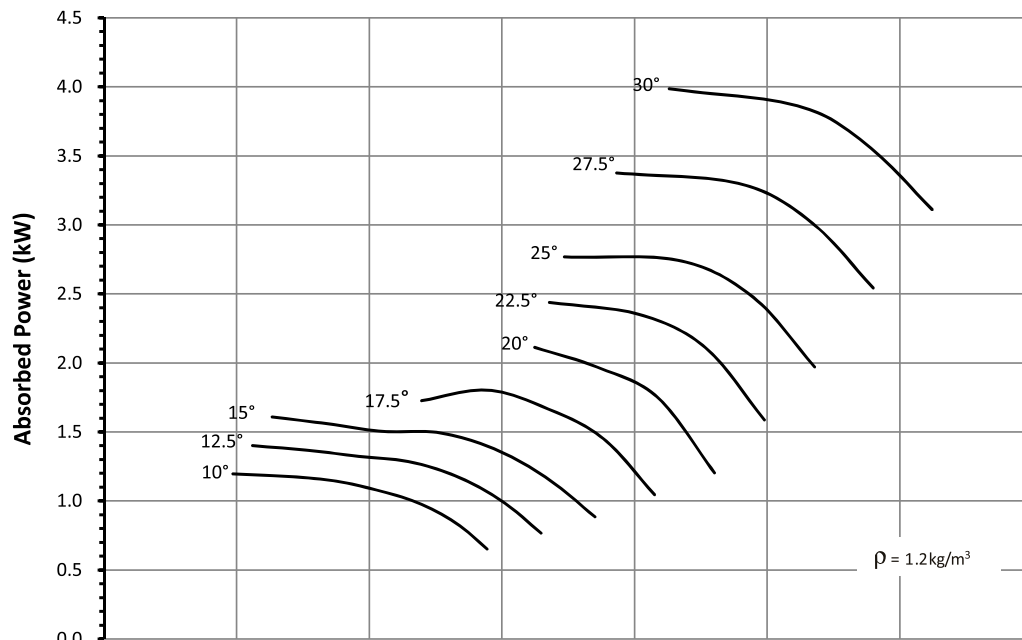

Ref	Full Octave Band Center Frequency								L _W A dB(A)
	63	125	250	500	1K	2K	4K	8K	
a	83	82	86	83	82	81	78	68	88
b	82	81	84	82	82	83	79	69	88
c	82	84	89	90	88	82	75	67	92
d	86	86	92	84	81	77	73	68	87
e	84	84	90	86	83	82	79	70	89
f	82	83	89	85	83	81	78	71	89
g	82	83	89	90	88	85	80	72	92
h	86	88	93	93	90	84	78	73	94
j	85	85	92	87	84	82	84	91	93
k	84	85	91	86	83	81	83	92	93
m	85	84	89	88	85	82	83	91	93
n	91	95	94	94	90	84	81	83	95



Performance certified is for Installation type D: Ducted Inlet- Ducted Outlet. Performance ratings do not include the effects of appurtenances (accessories) Power rating kW is fan input power. The Sound Power Level ratings shown are in decibels, referred to 10-12 watts, calculated per AMCA International Standard 301. Values shown are for inlet LWi and LWiA sound power levels for Installation type D: Ducted Inlet-Ducted Outlet. Ratings include the effects of duct end correction. The A-weighted sound ratings shown have been calculated per AMCA International Standard 301.

6 Pole - 1152 rpm

Performance Curve FEG 60

ADTA 900-400-08
ADTA-F 900-400-08

60Hz 1152 rpm

Outlet Area: 0.636 m²

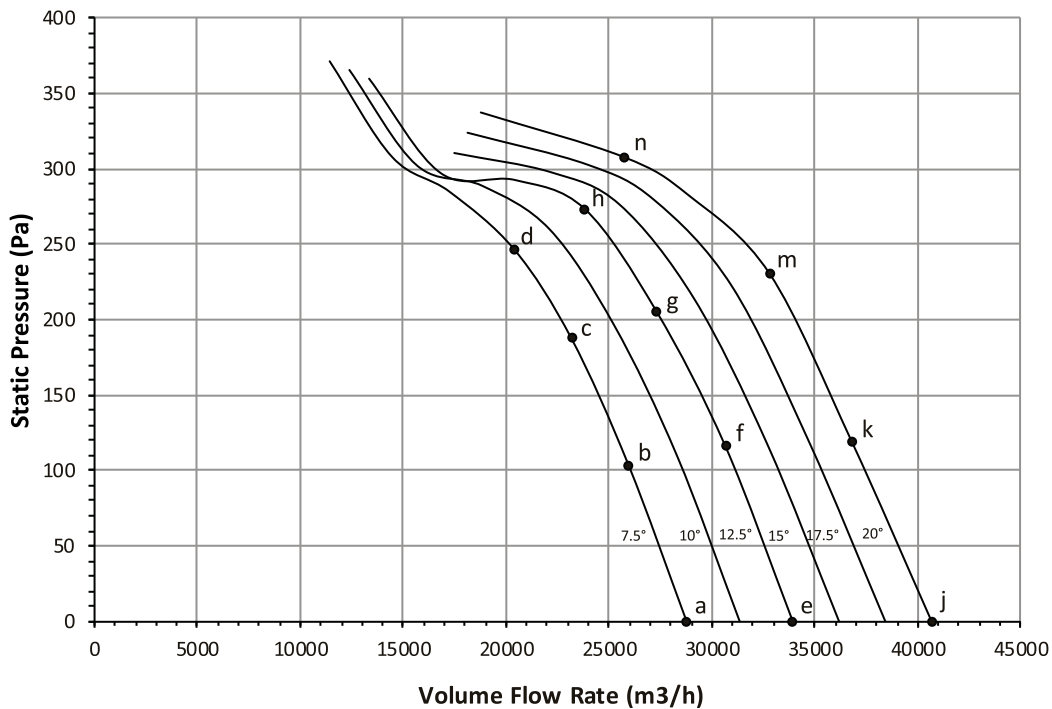
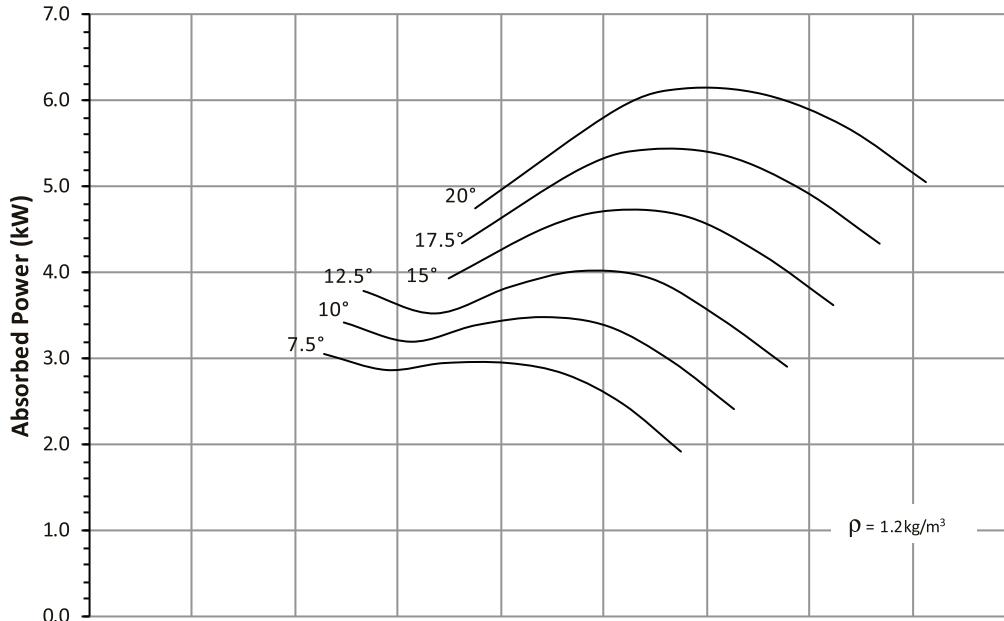

Ref	Full Octave Band Center Frequency								L _{WA} dB(A)
	63	125	250	500	1K	2K	4K	8K	
a	85	88	89	88	83	80	79	75	89
b	82	87	88	88	84	81	78	73	90
c	84	87	89	91	87	84	80	74	93
d	87	93	95	97	94	88	81	74	98
e	85	90	90	89	84	81	78	74	90
f	85	89	89	88	84	81	78	72	90
g	86	90	90	91	87	84	81	75	93
h	89	96	97	97	92	88	82	76	98
j	88	93	93	91	87	83	79	73	93
k	89	93	94	90	87	83	80	74	93
m	89	92	92	90	87	84	81	77	93
n	91	97	96	94	91	87	84	80	96



Performance certified for Installation type D: Ducted Inlet- Ducted Outlet. Performance ratings do not include the effects of appurtenances (accessories)
Power rating kW is fan input power.
The Sound Power Level ratings shown are in decibels, referred to 10⁻¹² watts, calculated per AMCA International Standard 301. Values shown are for inlet L_w and L_{wA} sound power levels for Installation type D: Ducted Inlet-Ducted Outlet. Ratings include the effects of duct end correction.
The A-weighted sound ratings shown have been calculated per AMCA International Standard 301.

6 Pole - 1152 rpm

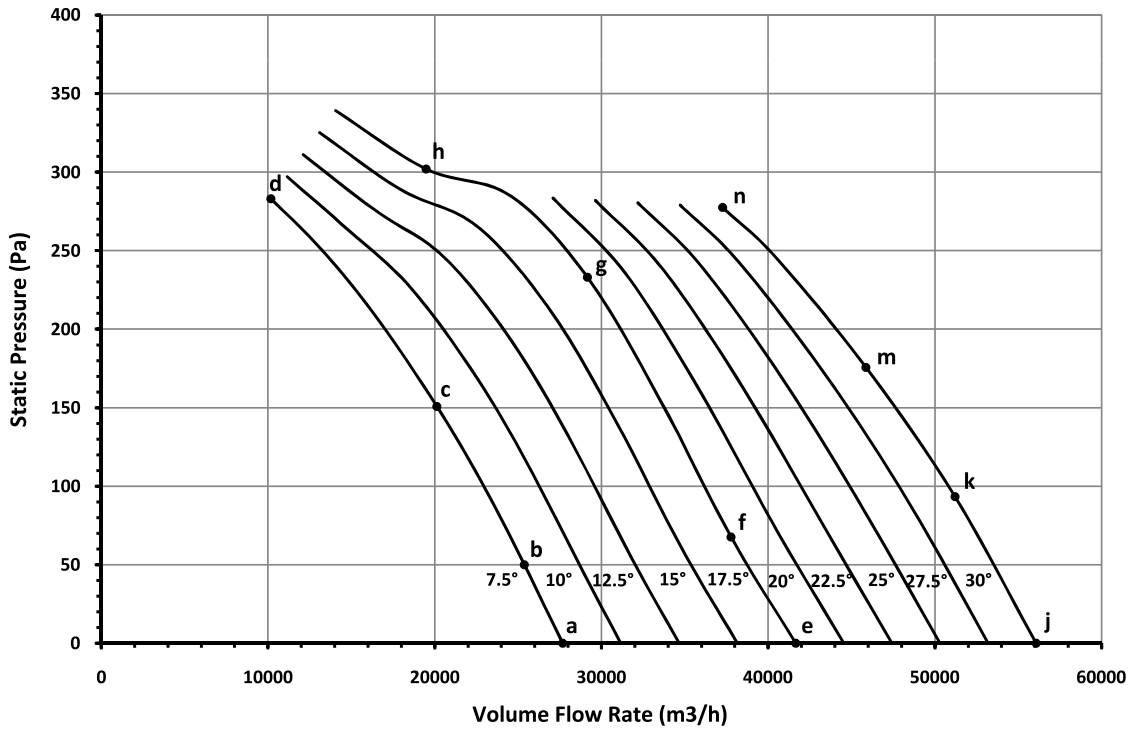
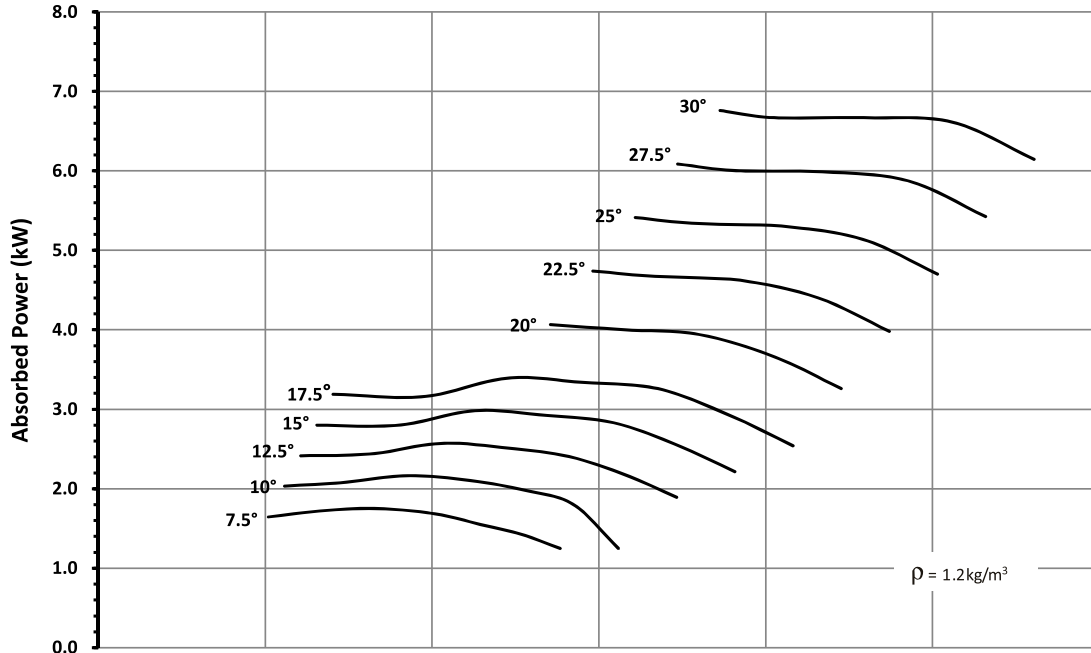

6 Pole - 1152 rpm

Ref	Full Octave Band Center Frequency								L _{WA} dB(A)
	63	125	250	500	1K	2K	4K	8K	
a	80	85.2	88.3	88	87	85	83	78	92
b	79	84	87	88	89	87	84	79	93
c	80	83	89	94	93	88	83	76	96
d	86	94	101	96	90	84	79	73	97
e	88	88	90	89	86	84	83	80	92
f	87	86	89	89	86	84	81	77	91
g	87	86	92	97	93	88	83	78	98
h	89	92	102	104	98	91	84	78	103
j	90	92	94	93	90	86	84	82	95
k	90	92	93	93	90	86	84	82	95
m	90	91	92	92	90	87	85	83	95
n	91	91	95	95	92	89	86	84	97



Performance certified is for Installation type D: Ducted Inlet- Ducted Outlet. Performance ratings do not include the effects of appurtenances (accessories). Power rating kW is fan input power. The Sound Power Level ratings shown are in decibels, referred to 10⁻¹² watts, calculated per AMCA International Standard 301. Values shown are for inlet L_{WA} and L_{WA} sound power levels for Installation type D: Ducted Inlet-Ducted Outlet. Ratings include the effects of duct end correction. The A-weighted sound ratings shown have been calculated per AMCA International Standard 301.

Performance Curve
FEG 63

ADTA 1000-400-08
ADTA-F 1000-400-08

60Hz 1152 rpm

Outlet Area: 0.785 m²

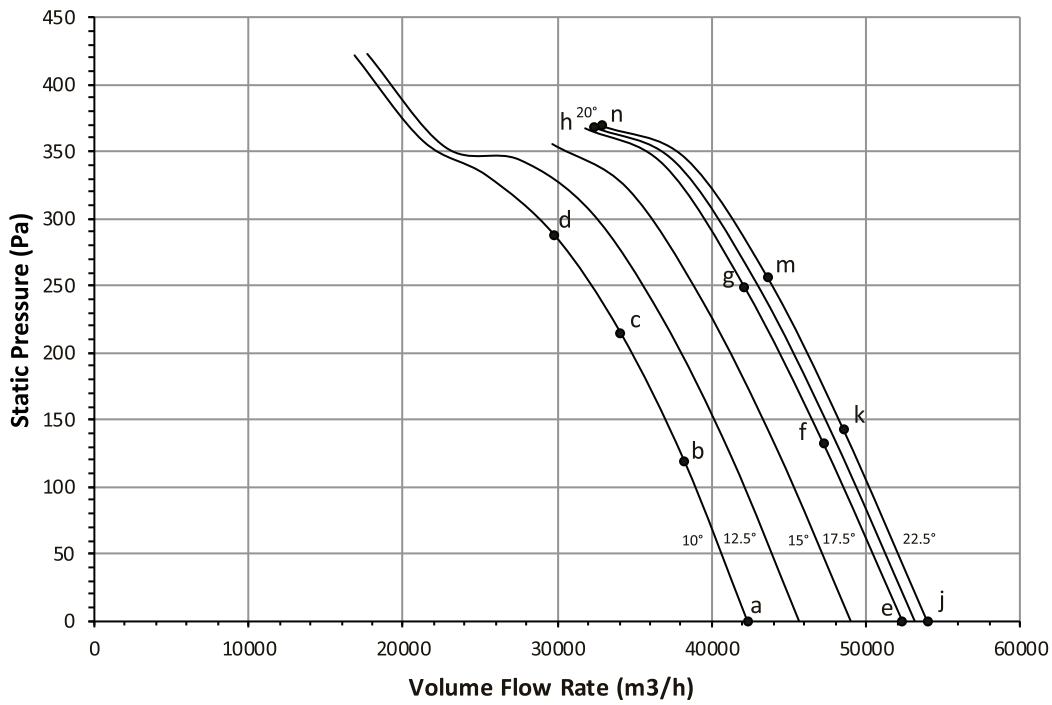
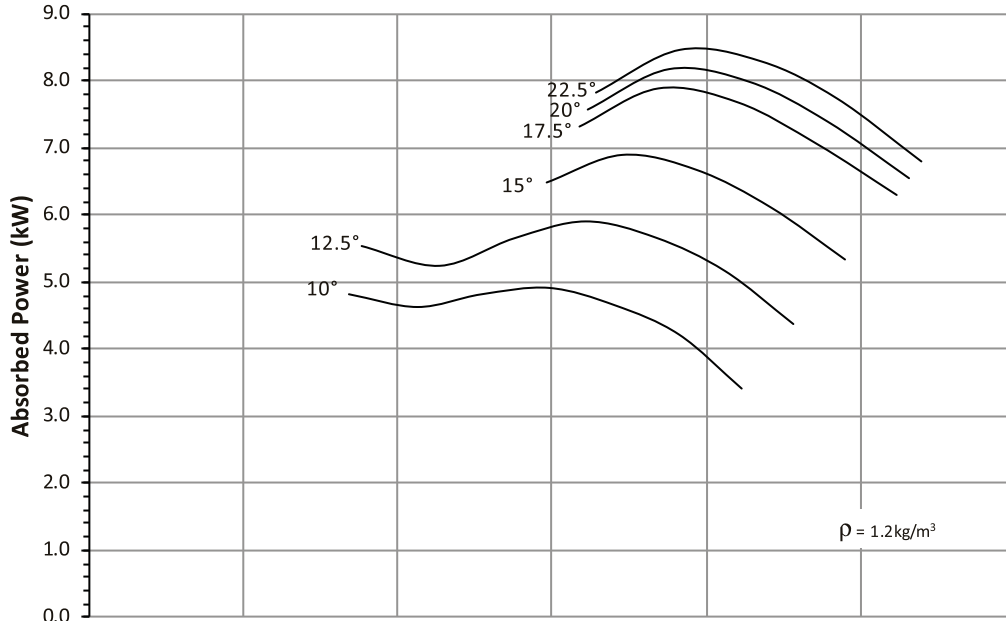

Ref	Full Octave Band Center Frequency								L _w A
	63	125	250	500	1K	2K	4K	8K	
a	89	91	91	90	87	84	83	81	93
b	89	91	91	90	87	85	83	79	93
c	89	93	93	95	93	89	85	79	97
d	92	101	101	100	97	91	85	79	102
e	91	94	94	93	89	86	83	78	95
f	91	94	93	92	88	85	83	78	94
g	91	94	94	93	91	88	85	81	96
h	96	107	106	102	98	93	88	82	104
j	91	94	94	93	89	86	83	78	95
k	91	94	94	92	89	86	84	78	95
m	91	94	94	94	91	89	85	81	96
n	96	107	106	101	97	92	88	82	103



Performance certified is for Installation type D: Ducted Inlet- Ducted Outlet. Performance ratings do not include the effects of appurtenances (accessories) Power rating kW is fan input power. The Sound Power Level ratings shown are in decibels, referred to 10⁻¹² watts, calculated per AMCA International Standard 301. Values shown are for inlet L_w and L_wA sound power levels for Installation type D: Ducted Inlet-Ducted Outlet. Ratings include the effects of duct end correction. The A-weighted sound ratings shown have been calculated per AMCA International Standard 301.

6 Pole - 1152 rpm

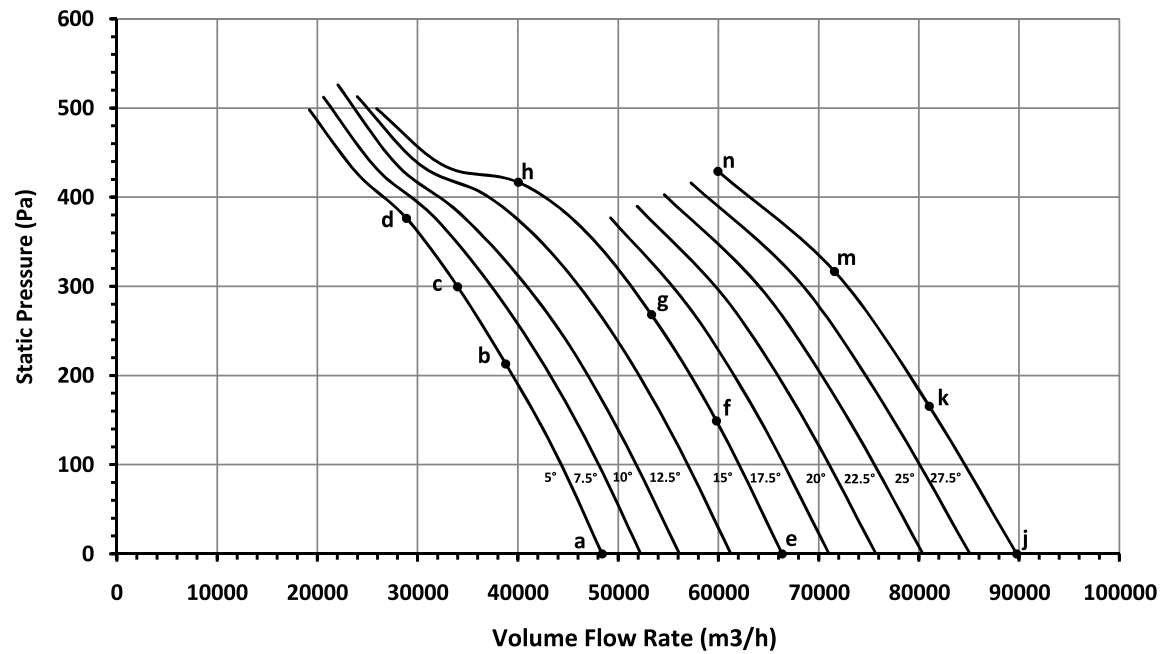
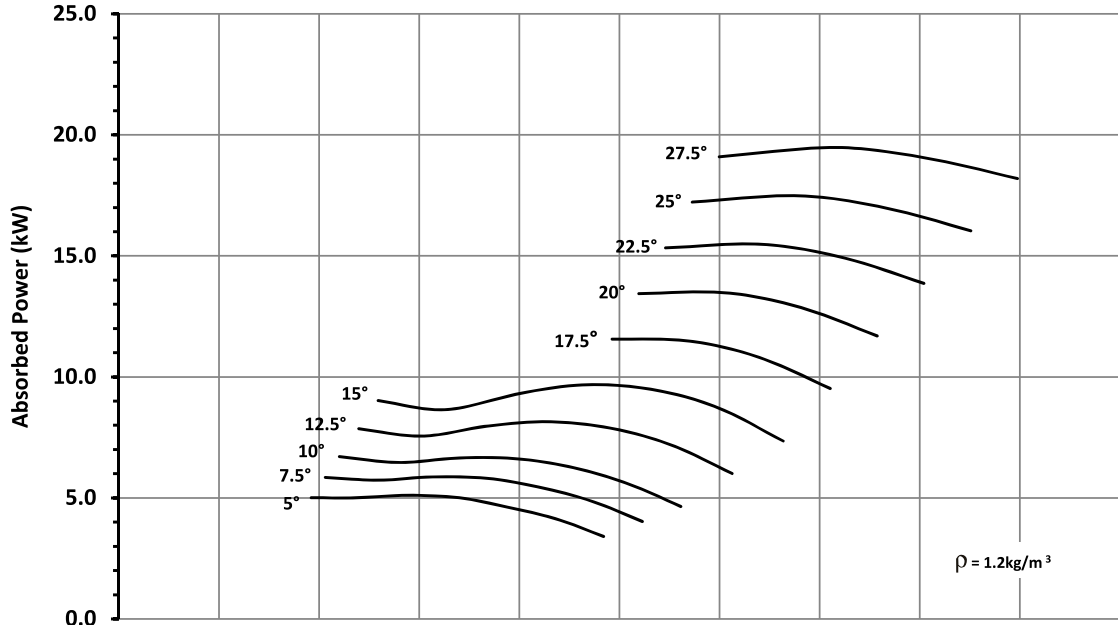

6 Pole - 1152 rpm

Ref	Full Octave Band Center Frequency								L _{WA} dB(A)
	63	125	250	500	1K	2K	4K	8K	
a	91	90	92	93	91	88	86	86	96
b	89	94	96	100	99	96	90	83	103
c	91	101	101	101	99	94	88	81	103
d	94	103	102	100	97	92	86	80	102
e	96	97	96	93	91	87	85	83	96
f	94	95	94	92	91	88	86	82	96
g	96	97	97	97	96	93	90	85	100
h	103	108	105	101	98	93	89	83	104
j	105	101	98	97	95	91	89	86	100
k	108	102	98	97	95	92	90	87	100
m	105	102	97	96	96	92	91	88	100
n	103	105	103	101	99	95	91	87	104



Performance certified is for Installation type D: Ducted Inlet- Ducted Outlet. Performance ratings do not include the effects of appurtenances (accessories) Power rating kW is fan input power. The Sound Power Level ratings shown are in decibels, referred to 10⁻¹² watts, calculated per AMCA International Standard 301. Values shown are for outlet L_{wo} and L_{woA} sound power levels for Installation type D: Ducted Inlet-Ducted Outlet. Ratings include the effects of duct end correction. The A-weighted sound ratings shown have been calculated per AMCA International Standard 301.

Performance Curve
FEG 75

ADTA 1250-400-08
ADTA-F 1250-400-08

60Hz 1152rpm

Outlet Area: 1.227 m²

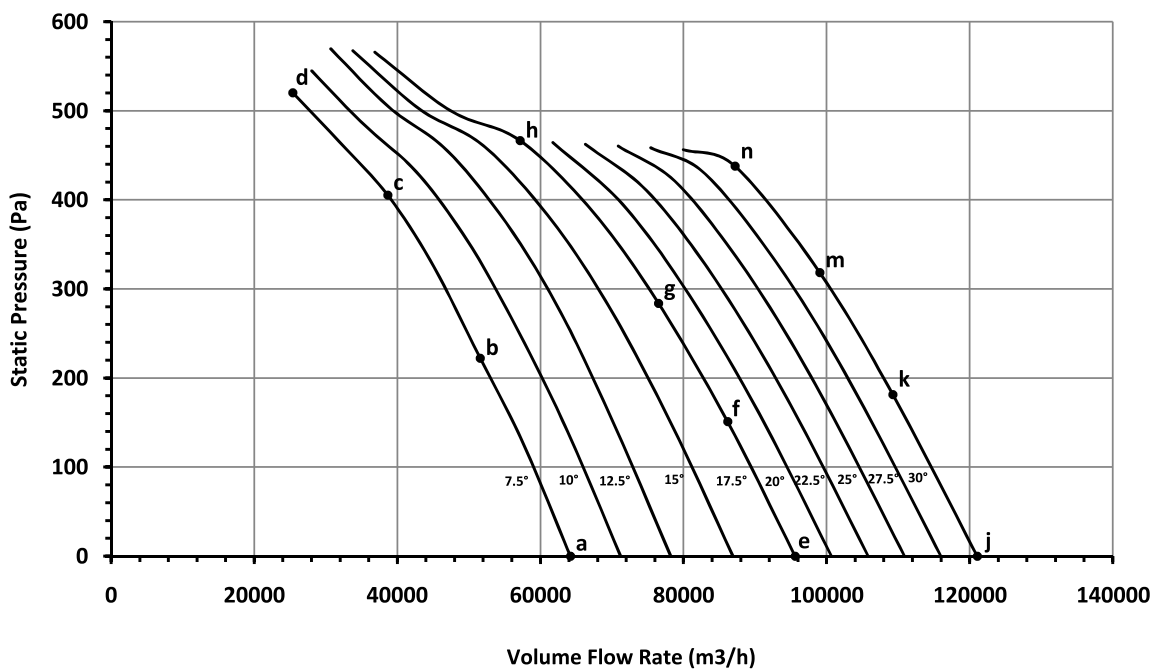
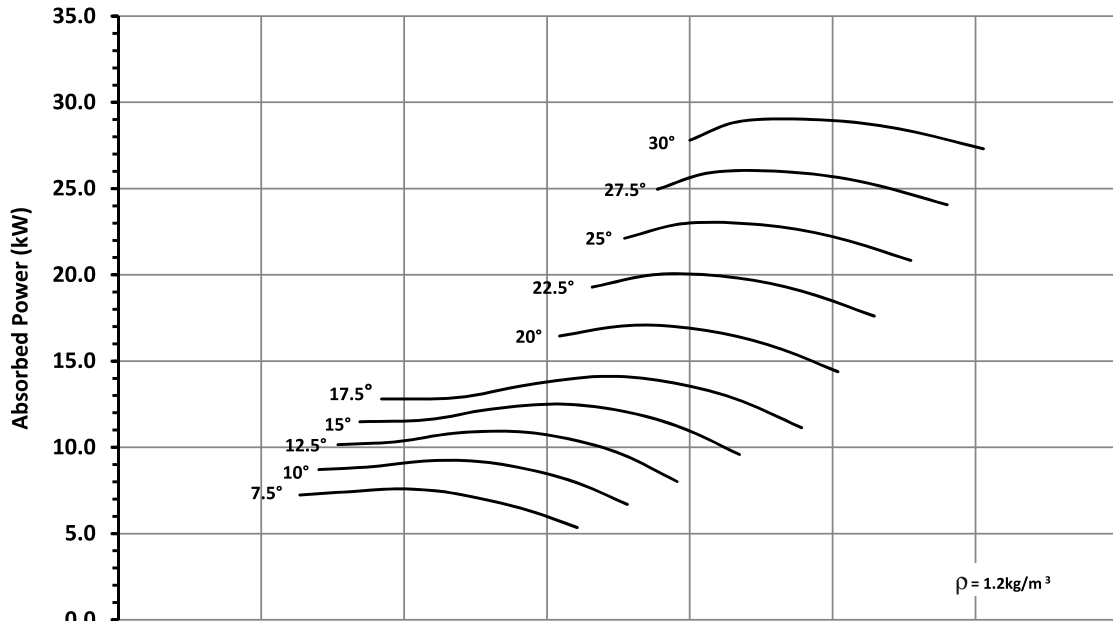

Ref	Full Octave Band Center Frequency								L _w A dB(A)
	63	125	250	500	1K	2K	4K	8K	
a	94	93	95	97	95	91	90	91	100
b	92	97	99	102	102	97	92	86	105
c	94	105	104	103	100	95	90	84	105
d	101	104	101	98	95	91	89	85	100
e	99	101	100	97	95	91	90	90	100
f	95	100	99	98	97	94	91	89	101
g	99	103	103	103	102	98	94	89	106
h	100	112	110	107	103	98	93	88	109
j	114	108	102	101	98	95	91	89	104
k	113	107	102	101	98	95	92	90	104
m	110	105	101	100	99	96	93	91	104
n	107	108	107	107	104	99	95	91	109



Performance certified for Installation type D: Ducted Inlet- Ducted Outlet. Performance ratings do not include the effects of appurtenances (accessories) Power rating kW is fan input power. The Sound Power Level ratings shown are in decibels, referred to 10⁻¹² watts, calculated per AMCA International Standard 301. Values shown are for outlet L_w and L_wA sound power levels for Installation type D: Ducted Inlet-Ducted Outlet. Ratings include the effects of duct end correction. The A-weighted sound ratings shown have been calculated per AMCA International Standard 301.

6 Pole - 1152 rpm

Performance Curve FEG 75

ADTA 1250-400-12
ADTA-F 1250-400-12

60Hz 1152rpm

Outlet Area: 1.227 m²

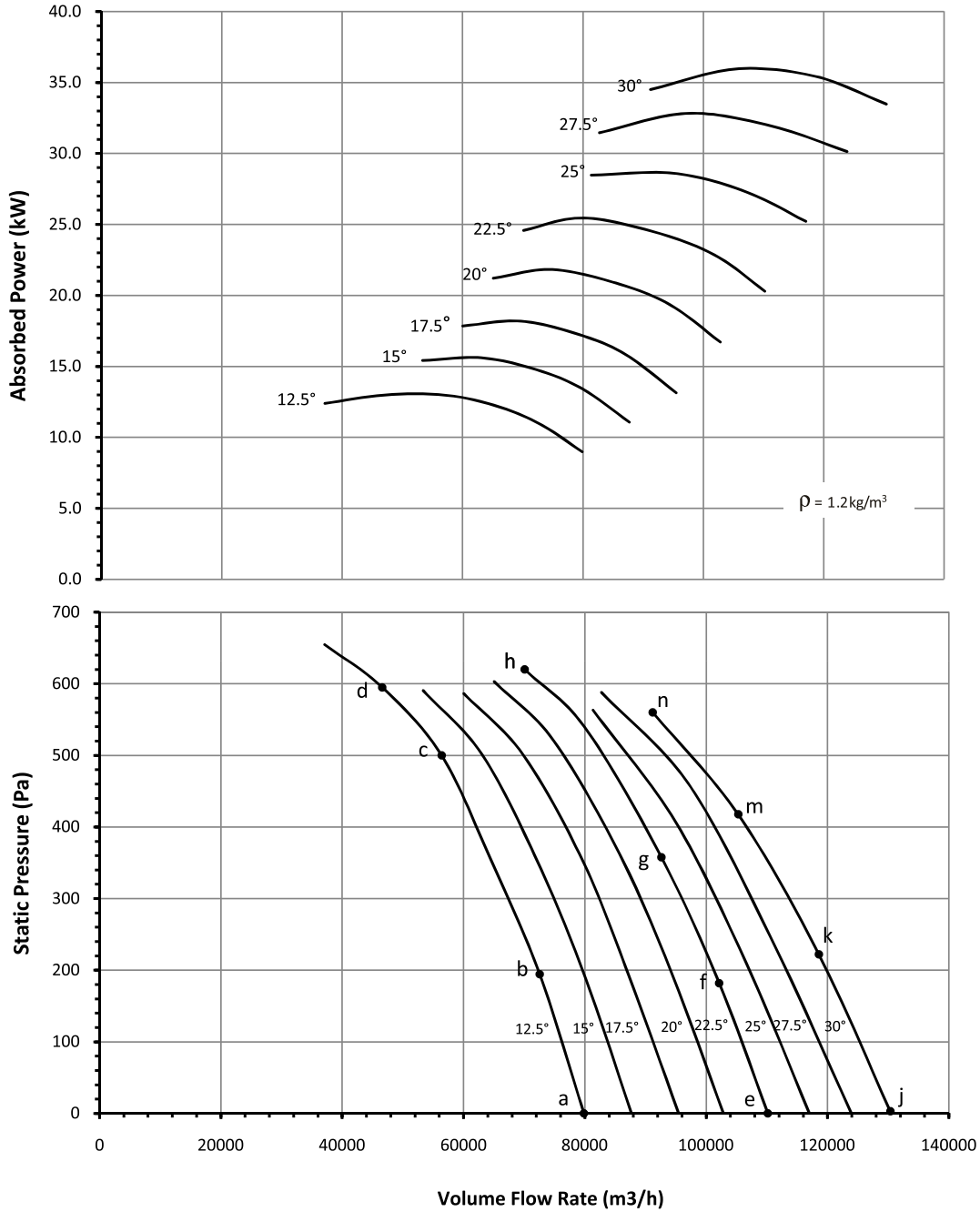

Ref	Full Octave Band Center Frequency								L _w /A
	63	125	250	500	1K	2K	4K	8K	
a	100	94	100	98	96	94	94	89	102
b	100	94	99	97	96	97	95	89	103
c	96	97	109	106	103	99	93	87	108
d	101	103	112	106	102	97	92	86	108
e	106	99	102	99	98	94	92	89	103
f	107	100	101	99	97	95	92	89	102
g	103	98	101	100	99	97	93	90	104
h	102	108	109	107	105	101	96	91	109
j	108	102	102	100	99	96	93	91	104
k	110	103	102	101	99	97	94	91	104
m	105	101	104	103	101	99	95	92	108
n	105	113	109	108	106	102	97	92	111



Performance certified for Installation type D: Ducted Inlet- Ducted Outlet. Performance ratings do not include the effects of appurtenances (accessories). Power rating kW is fan input power. The Sound Power Level ratings shown are in decibels, referred to 10-12 watts, calculated per AMCA International Standard 301. Values shown are for outlet L_w and L_wA sound power levels for Installation type D: Ducted Inlet-Ducted Outlet. Ratings include the effects of duct end correction. The A-weighted sound ratings shown have been calculated per AMCA International Standard 301.

6 Pole - 1152 rpm

Performance Curve
FEG 67

ADTA 1400-400-08
ADTA-F 1400-400-08

60Hz 1152 rpm
Outlet Area: 1.550 m²

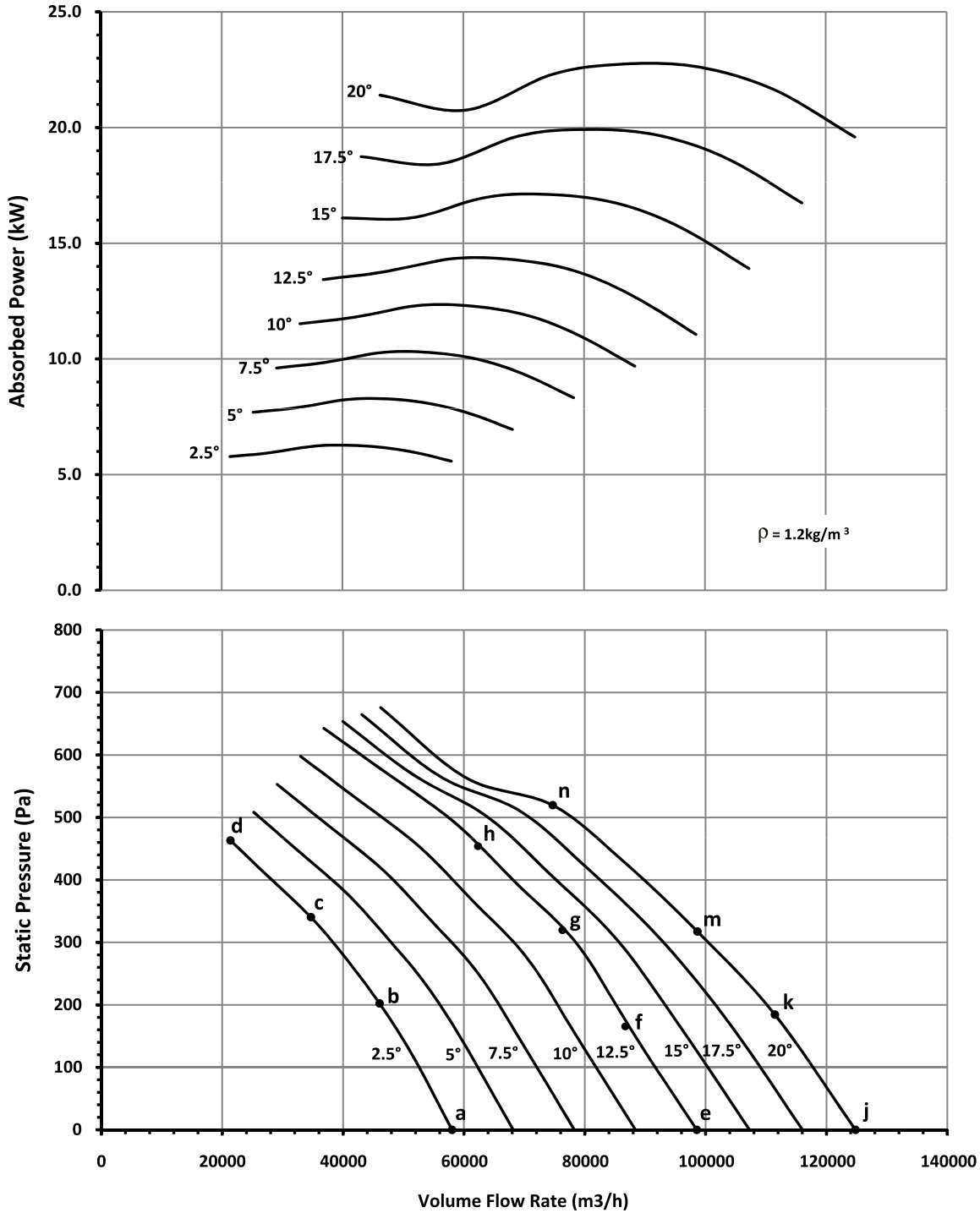

Ref	Full Octave Band Center Frequency								L _{W0A} dB(A)
	63	125	250	500	1K	2K	4K	8K	
a	93	95	97	102	101	98	95	89	106
b	93	100	102	104	101	97	93	87	106
c	96	104	104	101	98	95	91	85	103
d	99	100	99	96	94	92	89	85	100
e	96	96	96	98	102	102	98	92	107
f	96	96	97	100	102	102	98	91	107
g	96	99	101	104	104	101	96	91	108
h	96	107	107	106	103	100	95	90	108
j	99	102	101	99	102	102	98	92	107
k	97	101	102	103	104	103	98	92	108
m	98	102	104	107	106	103	98	93	110
n	111	111	108	105	102	100	96	91	108



Performance certified is for Installation type A: Free Inlet-Free Outlet. Performance ratings do not include the effects of appurtenances (accessories). Power rating kW is fan input power. The Sound Power Level ratings shown are in decibels, referred to 10⁻¹² watts, calculated per AMCA International Standard 301. Values shown are for outlet L_{W0} and L_{W0A} sound power levels for Installation type A: Free Inlet - Free Outlet. The A-weighted sound ratings shown have been calculated per AMCA International Standard 301.

6 Pole - 1152 rpm

Performance Curve FEG 60

ADTA 1400-400-12
ADTA-F 1400-400-12

60Hz 1152 rpm

Outlet Area: 1.550 m²

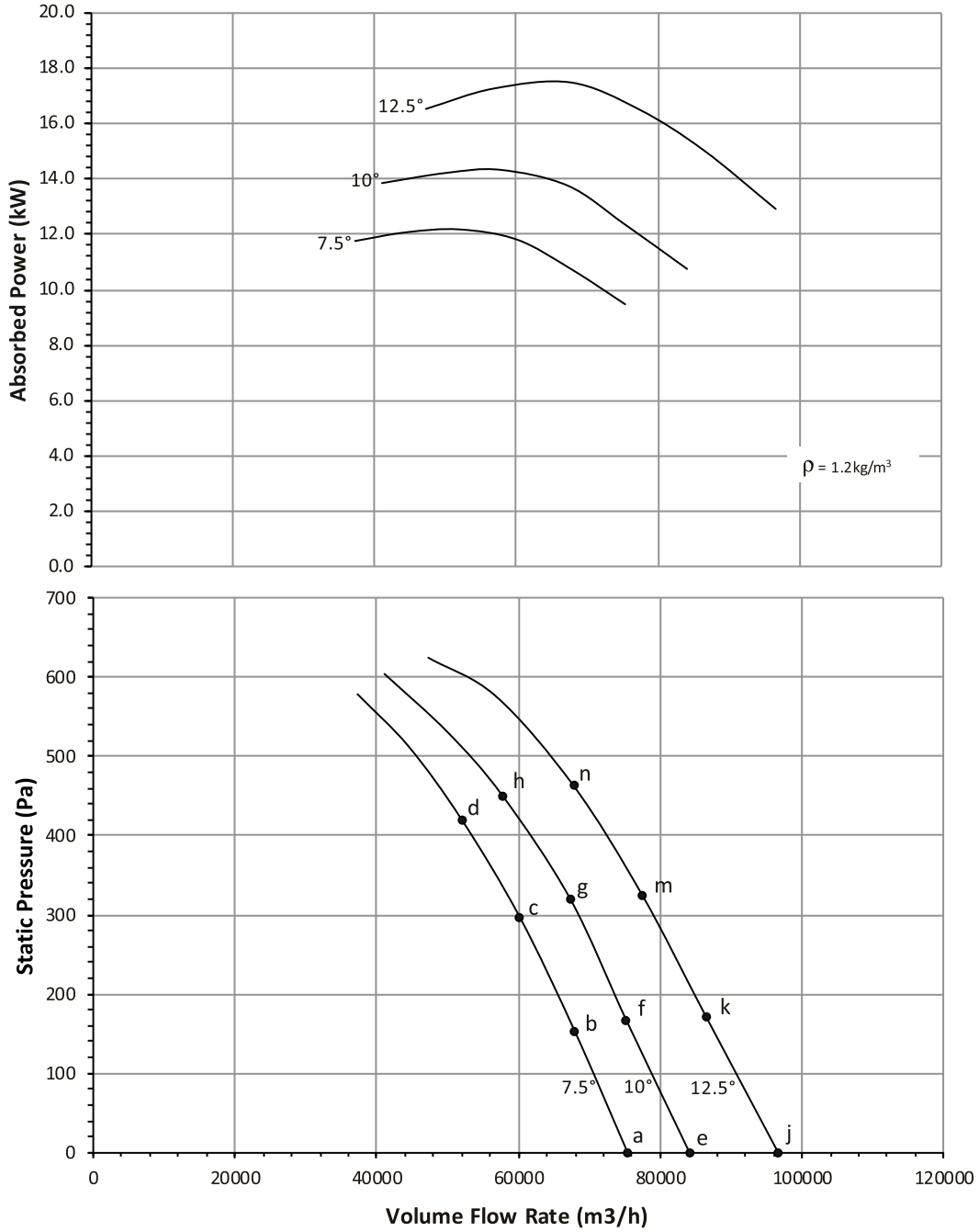

Ref	Full Octave Band Center Frequency								L _w /A dB(A)
	63	125	250	500	1K	2K	4K	8K	
a	91	94	100	102	104	102	98	92	108
b	92	95	103	105	105	102	97	90	109
c	95	98	106	106	105	101	96	89	109
d	96	100	107	106	103	100	94	87	108
e	94	96	100	101	104	103	98	93	108
f	96	98	103	104	106	102	97	91	109
g	96	100	107	107	106	102	96	89	110
h	97	100	107	107	104	101	95	88	109
j	94	95	99	100	104	104	100	94	109
k	95	98	103	104	107	103	98	91	110
m	97	101	109	108	107	102	97	90	111
n	99	102	109	108	105	102	96	89	110



Performance certified is for Installation type A: Free Inlet-Free Outlet. Performance ratings do not include the effects of appurtenances (accessories)

Power rating kW is fan input power.

The Sound Power Level ratings shown are in decibels, referred to 10⁻¹² watts, calculated per AMCA International Standard 301. Values shown are for outlet L_w and L_w/A sound power levels for Installation type A: Free Inlet - Free Outlet.

The A-weighted sound ratings shown have been calculated per AMCA International Standard 301.

6 Pole - 1152 rpm

Performance Curve
FEG 67

ADTA 1600-400-08
ADTA-F 1600-400-08

60Hz 1152 rpm
Outlet Area: 2.023 m²

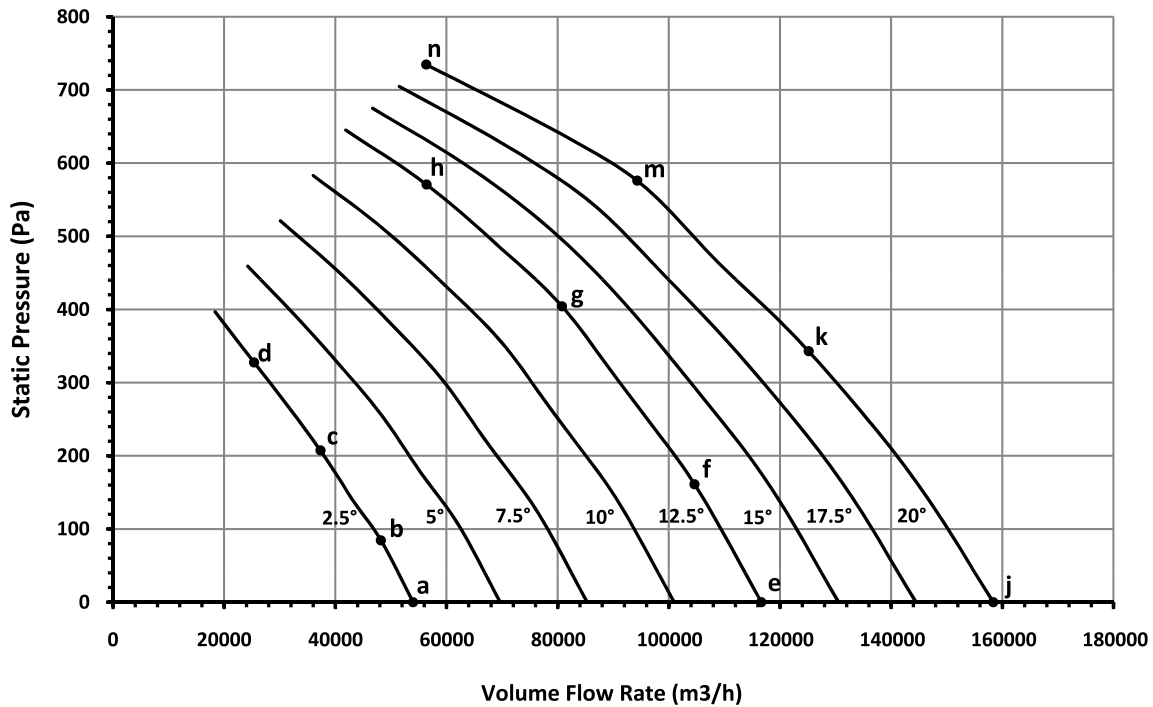
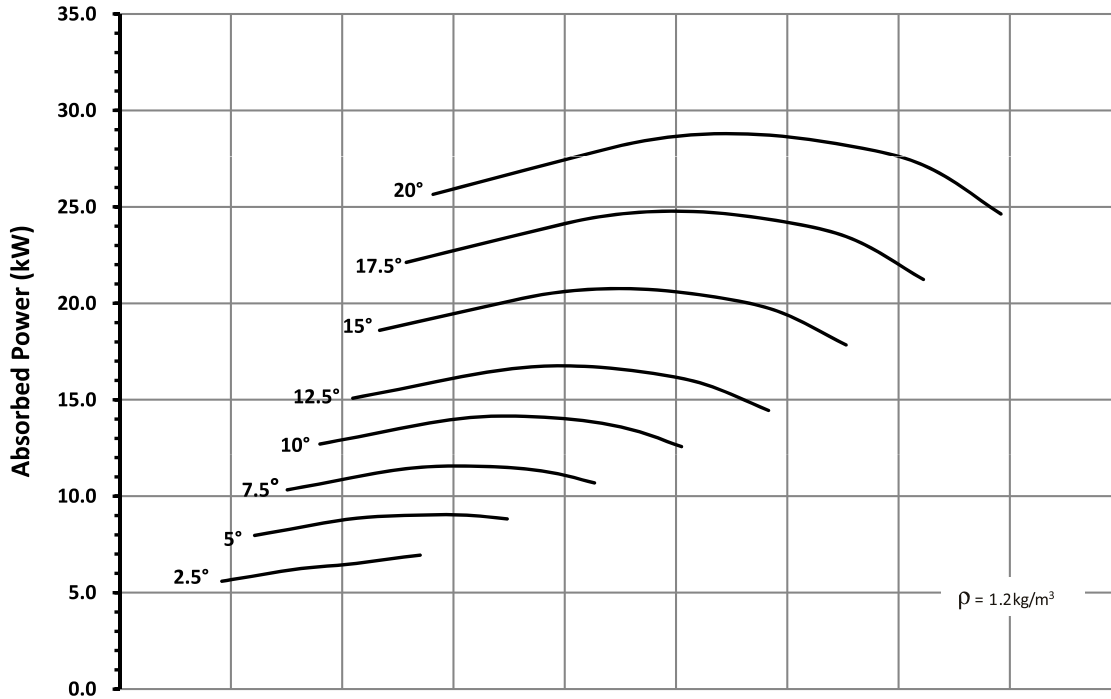

Ref	Full Octave Band Center Frequency								L _w A dB(A)
	63	125	250	500	1K	2K	4K	8K	
a	100	104	105	106	104	101	96	91	108
b	99	103	104	104	103	101	96	91	107
c	98	100	100	100	100	99	96	91	105
d	99	100	100	99	99	98	95	93	104
e	98	100	101	105	106	104	100	95	110
f	97	102	103	107	107	103	99	93	110
g	95	103	105	108	105	101	96	91	109
h	99	106	106	104	101	98	94	90	106
j	101	101	102	104	107	106	101	96	111
k	101	103	105	109	108	105	100	94	112
m	99	106	107	109	107	103	99	95	111
n	105	106	106	105	103	101	98	94	108



Performance certified is for Installation type A: Free Inlet-Free Outlet. Performance ratings do not include the effects of appurtenances (accessories)
Power rating kW is fan input power.
The Sound Power Level ratings shown are in decibels, referred to 10⁻¹² watts, calculated per AMCA International Standard 301. Values shown are for outlet L_w and L_wA sound power levels for Installation type A: Free Inlet - Free Outlet.
The A-weighted sound ratings shown have been calculated per AMCA International Standard 301.

6 Pole - 1152 rpm

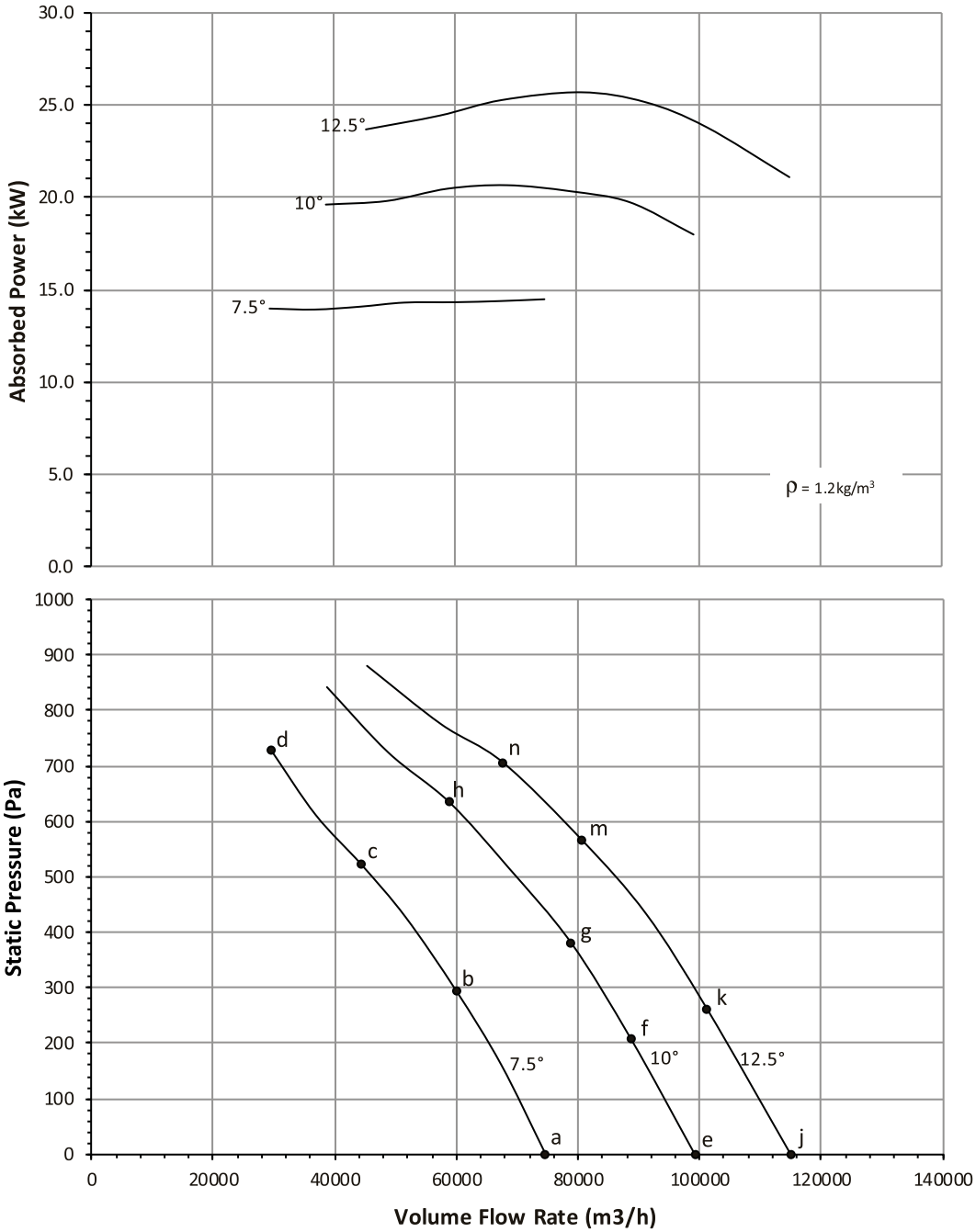

6 Pole - 1152 rpm

Ref	Full Octave Band Center Frequency								L _{WA} dB(A)
	63	125	250	500	1K	2K	4K	8K	
a	97	100	107	108	106	104	101	97	111
b	97	103	113	107	105	103	99	93	111
c	96	101	109	105	103	102	97	92	109
d	94	97	104	103	101	100	96	92	106
e	96	98	110	110	108	105	102	97	113
f	95	99	111	110	108	105	101	96	113
g	96	101	111	109	107	105	100	94	112
h	97	103	114	107	105	103	98	91	111
j	98	99	109	110	109	106	102	98	113
k	98	100	112	112	109	106	101	95	114
m	97	102	113	110	107	105	100	93	112
n	98	104	114	108	106	104	98	92	112



Performance certified is for Installation type A: Free Inlet-Free Outlet. Performance ratings do not include the effects of appurtenances (accessories). Power rating kW is fan input power. The Sound Power Level ratings shown are in decibels, referred to 10⁻¹² watts, calculated per AMCA International Standard 301. Values shown are for outlet L_{WA} and L_{WA}A sound power levels for Installation type A: Free Inlet - Free Outlet. The A-weighted sound ratings shown have been calculated per AMCA International Standard 301.

Performance Curve
FEG 75

ADTA 710-230-06
ADTA-F 710-230-06

60Hz 864 rpm

Outlet Area: 0.396 m²

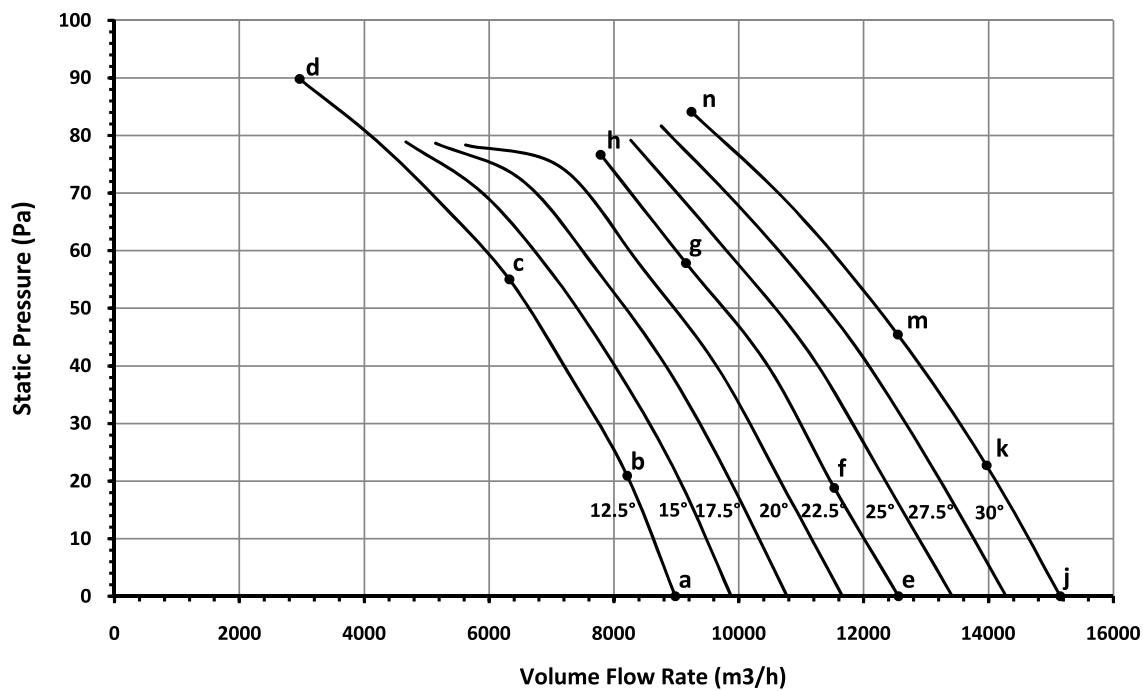
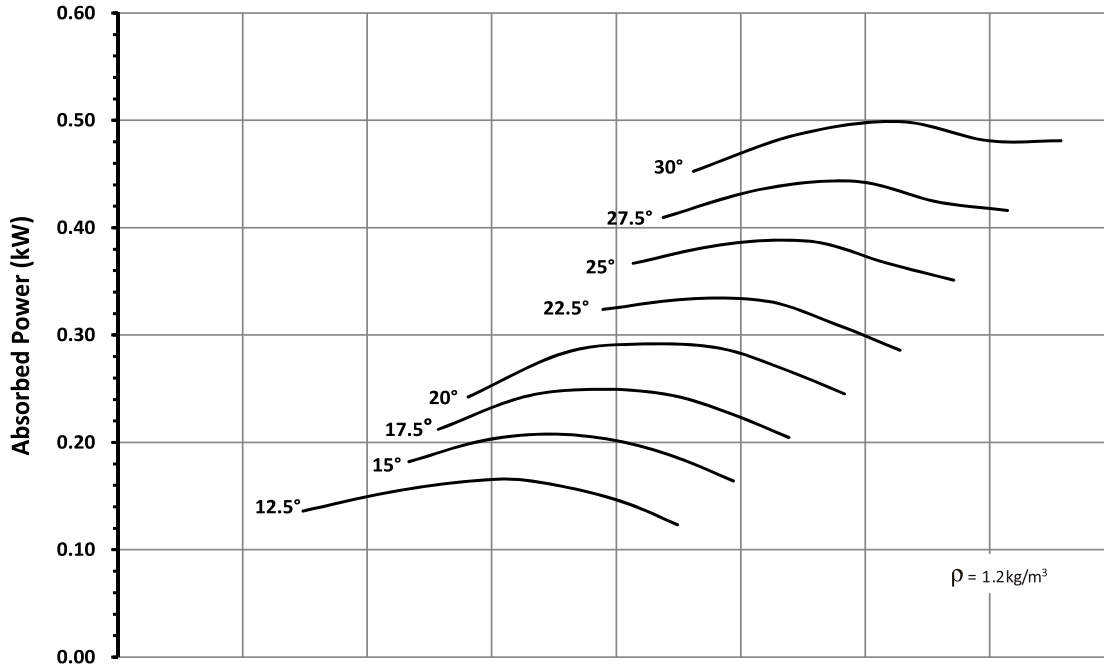

Ref	Full Octave Band Center Frequency								L _{WA} dB(A)
	63	125	250	500	1K	2K	4K	8K	
a	67	66	69	69	68	68	67	65	74
b	66	65	68	68	67	66	65	64	73
c	68	68	75	78	76	70	66	62	80
d	71	75	84	81	76	70	65	59	82
e	74	76	74	73	70	69	67	65	76
f	74	70	72	72	71	69	66	63	76
g	73	70	71	72	72	70	66	62	76
h	73	70	72	74	73	70	66	62	77
j	76	74	74	75	73	70	67	64	78
k	75	74	74	74	73	70	67	63	77
m	76	73	73	73	73	70	67	63	77
n	76	75	75	75	74	71	67	64	78



Performance certified is for Installation type D: Ducted Inlet- Ducted Outlet. Performance ratings do not include the effects of appurtenances (accessories) Power rating kW is fan input power. The Sound Power Level ratings shown are in decibels, referred to 10⁻¹² watts, calculated per AMCA International Standard 301. Values shown are for inlet L_{WA} and L_{WA} sound power levels for Installation type D: Ducted Inlet-Ducted Outlet. Ratings include the effects of duct end correction. The A-weighted sound ratings shown have been calculated per AMCA International Standard 301.

Performance Curve FEG 60

ADTA 710-230-12
ADTA-F 710-230-12

60Hz 864 rpm

Outlet Area: 0.396 m²

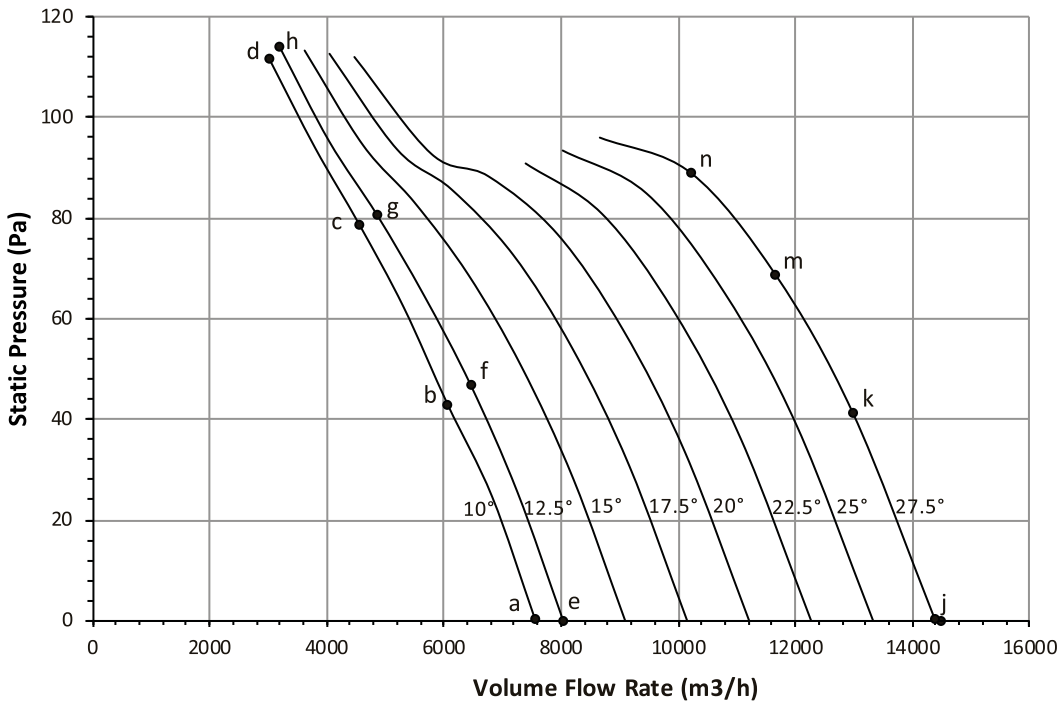
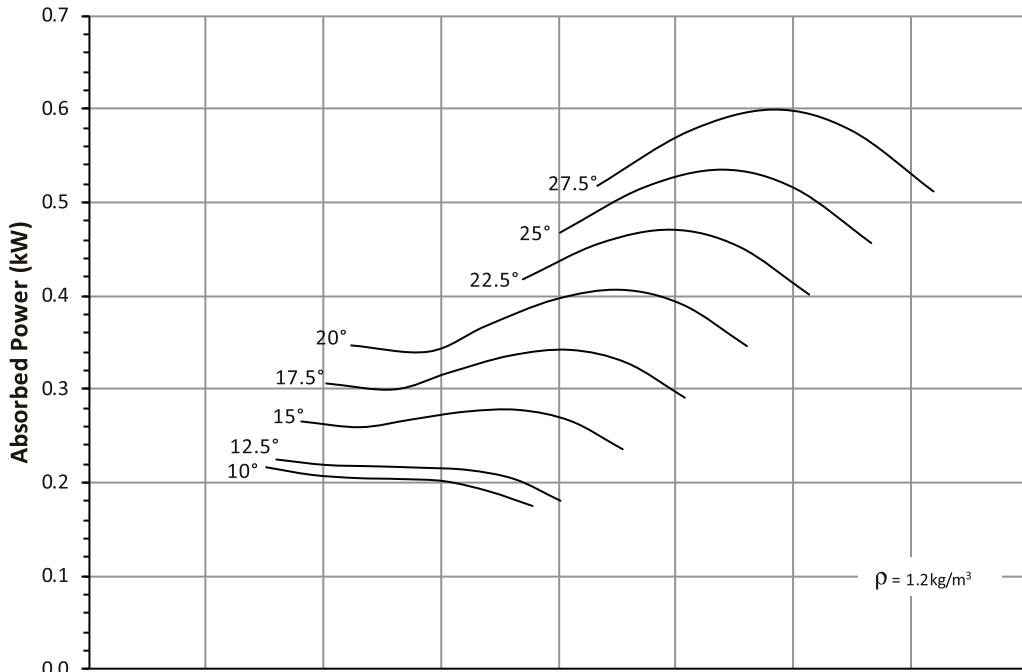

Ref	Full Octave Band Center Frequency								L _w /A dB(A)
	63	125	250	500	1K	2K	4K	8K	
a	71	72	74	76	76	73	69	65	80
b	71	73	79	81	78	73	68	61	82
c	76	84	82	79	76	70	64	57	81
d	76	79	74	72	70	68	62	55	75
e	71	72	74	75	75	74	69	64	80
f	71	73	80	81	78	73	68	61	82
g	76	85	82	80	76	70	64	57	81
h	78	78	74	72	70	67	61	56	75
j	72	79	76	75	73	72	70	67	79
k	73	80	78	76	74	73	70	67	80
m	76	80	83	80	77	74	70	65	83
n	82	85	85	83	80	75	69	62	85



Performance certified is for Installation type D: Ducted Inlet- Ducted Outlet. Performance ratings do not include the effects of appurtenances (accessories) Power rating kW is fan input power. The Sound Power Level ratings shown are in decibels, referred to 10⁻¹² watts, calculated per AMCA International Standard 301. Values shown are for inlet L_w and L_w/A sound power levels for Installation type D: Ducted Inlet-Ducted Outlet. Ratings include the effects of duct end correction. The A-weighted sound ratings shown have been calculated per AMCA International Standard 301.

Performance Curve
FEG 71

ADTA 710-250-12
ADTA-F 710-250-12

60Hz 864 rpm

Outlet Area: 0.396 m²

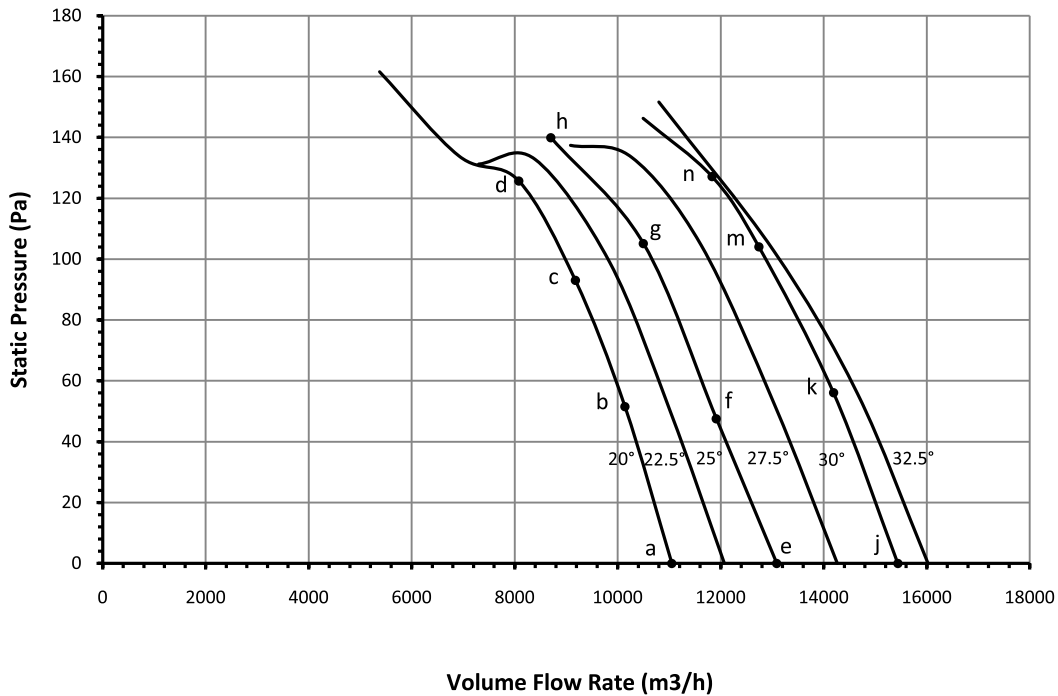
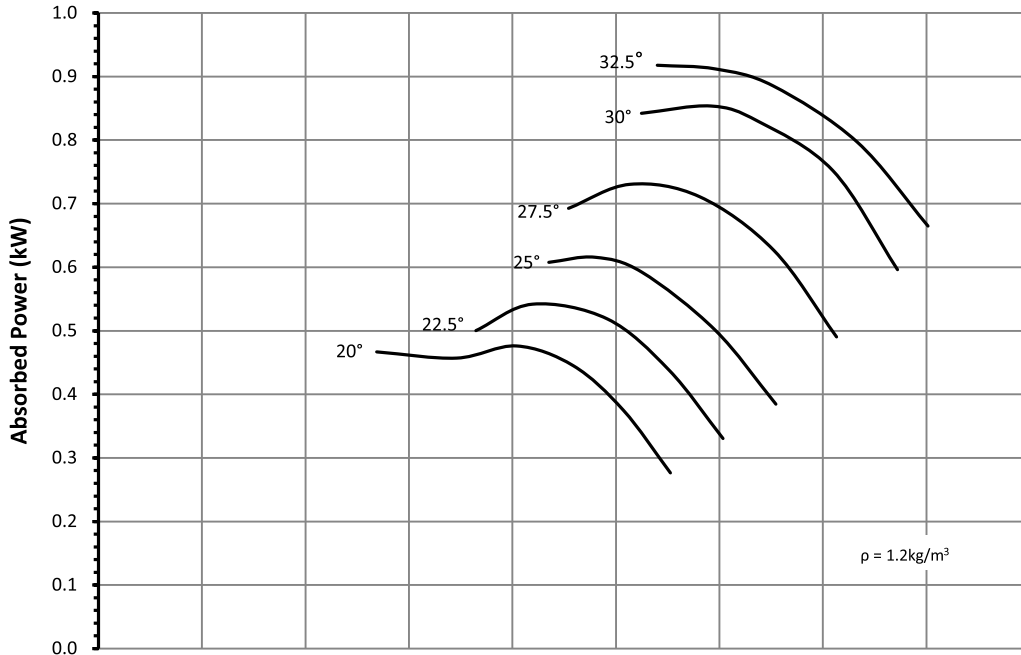

Ref	Full Octave Band Center Frequency								L _{W/A} dB(A)
	63	125	250	500	1K	2K	4K	8K	
a	71	75	75	73	72	72	64	55	77
b	71	74	73	72	71	70	64	57	76
c	70	74	76	75	73	70	64	57	78
d	74	78	84	81	77	72	65	58	82
e	72	75	75	74	73	72	66	59	78
f	72	75	74	74	72	70	66	64	77
g	72	75	76	74	73	69	67	65	77
h	82	84	85	82	77	72	67	64	83
j	74	76	77	76	74	72	73	75	81
k	74	77	76	75	72	70	69	69	78
m	73	77	76	74	72	68	66	64	77
n	78	81	79	77	74	70	67	64	79



Performance certified is for Installation type D: Ducted Inlet- Ducted Outlet. Performance ratings do not include the effects of appurtenances (accessories) Power rating kW is fan input power. The Sound Power Level ratings shown are in decibels, referred to 10-12 watts, calculated per AMCA International Standard 301. Values shown are for inlet LWi and LWiA sound power levels for Installation type D: Ducted Inlet-Ducted Outlet. Ratings include the effects of duct end correction. The A-weighted sound ratings shown have been calculated per AMCA International Standard 301.

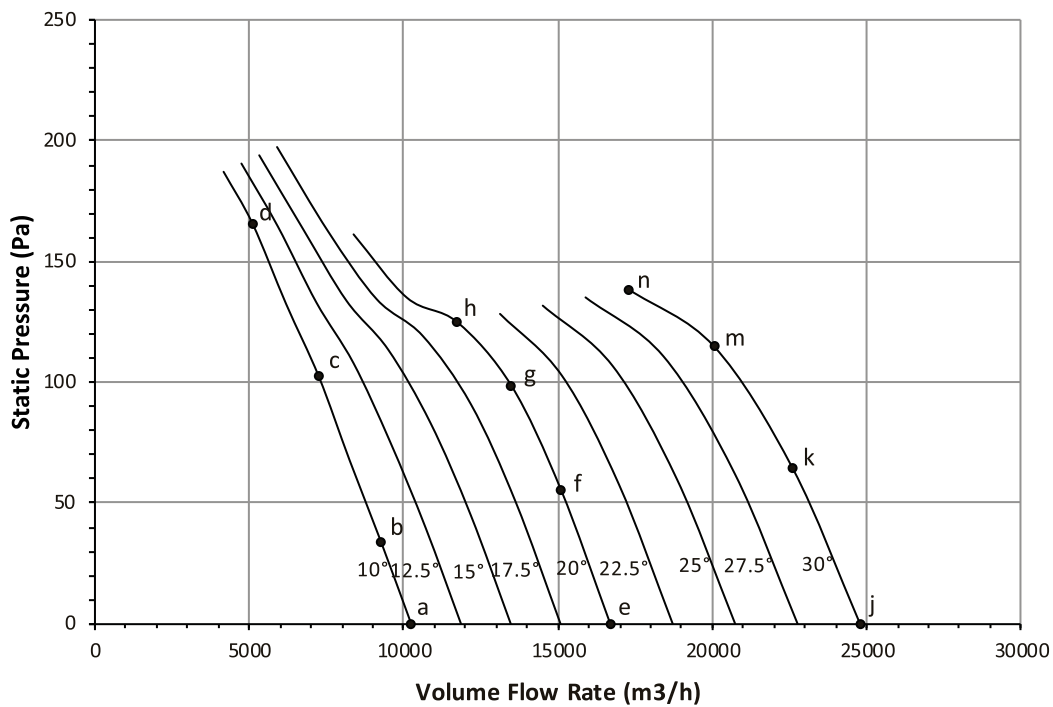
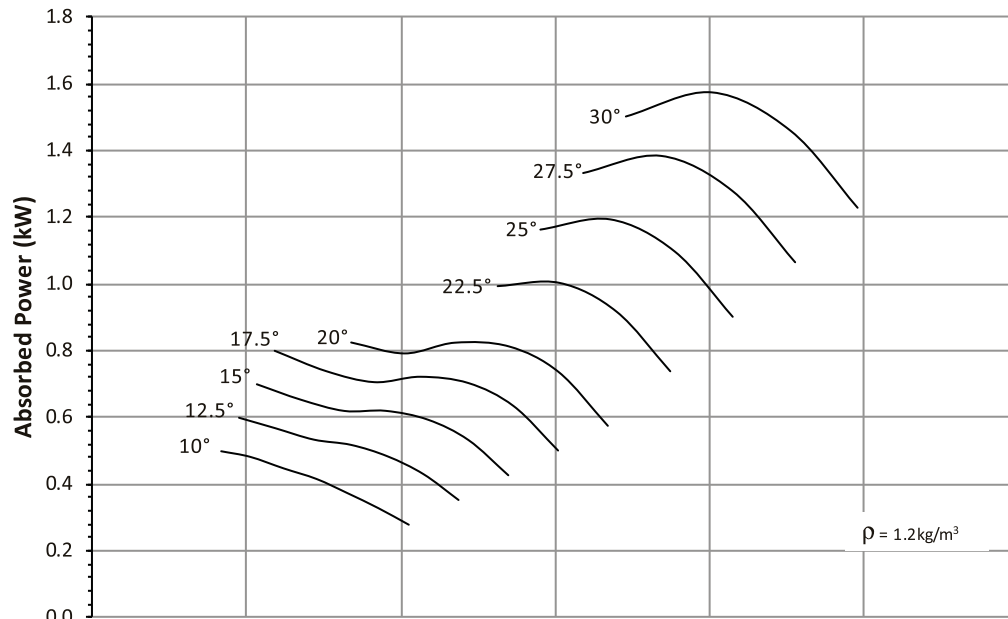

Ref	Full Octave Band Center Frequency								L _{WA} dB(A)
	63	125	250	500	1K	2K	4K	8K	
a	72	79	78	78	77	78	67	53	82
b	73	79	79	83	81	79	67	53	85
c	80	87	87	84	79	74	63	50	85
d	83	87	82	79	75	69	61	53	81
e	73	81	79	78	77	80	68	52	84
f	74	81	79	79	79	69	55	55	84
g	80	84	85	85	82	78	69	58	86
h	88	92	88	86	82	73	66	58	87
j	76	83	81	80	78	79	68	54	84
k	76	82	81	80	79	76	69	61	83
m	81	83	82	82	80	76	71	65	84
n	93	91	87	86	83	78	71	64	88



Performance certified is for Installation type D: Ducted Inlet- Ducted Outlet. Performance ratings do not include the effects of appurtenances (accessories) Power rating kW is fan input power. The Sound Power Level ratings shown are in decibels, referred to 10⁻¹² watts, calculated per AMCA International Standard 301. Values shown are for inlet L_{WA} and L_{WA} sound power levels for Installation type D: Ducted Inlet-Ducted Outlet. Ratings include the effects of duct end correction. The A-weighted sound ratings shown have been calculated per AMCA International Standard 301.

Performance Curve FEG 75

ADTA 800-250-12-T
ADTA-F 800-250-12-T

60Hz 864 rpm
Outlet Area: 0.503 m²

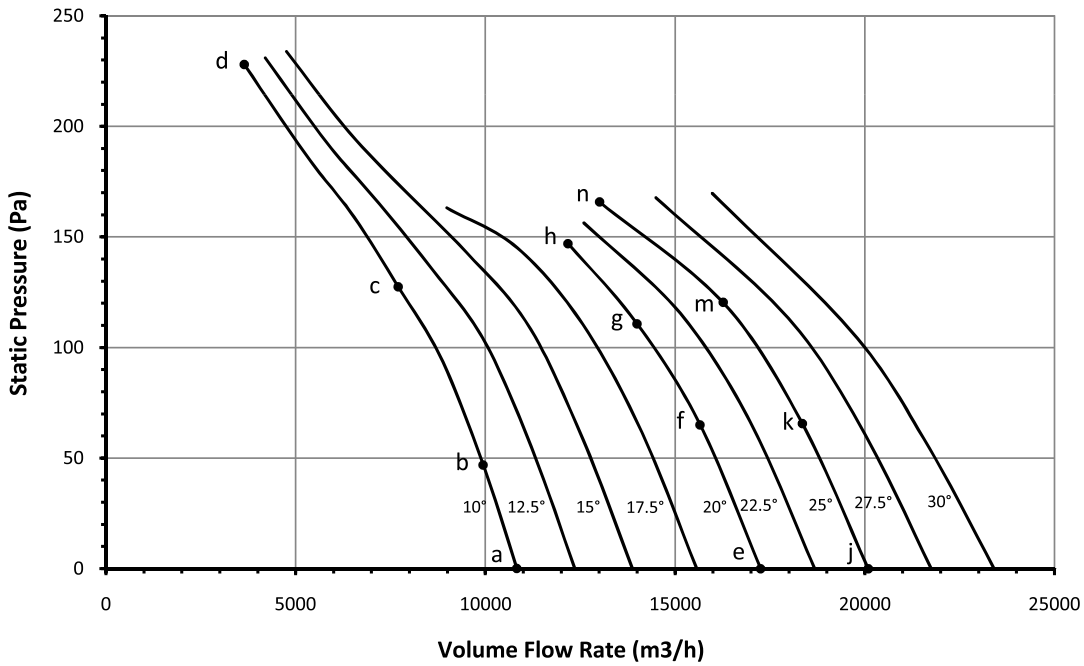
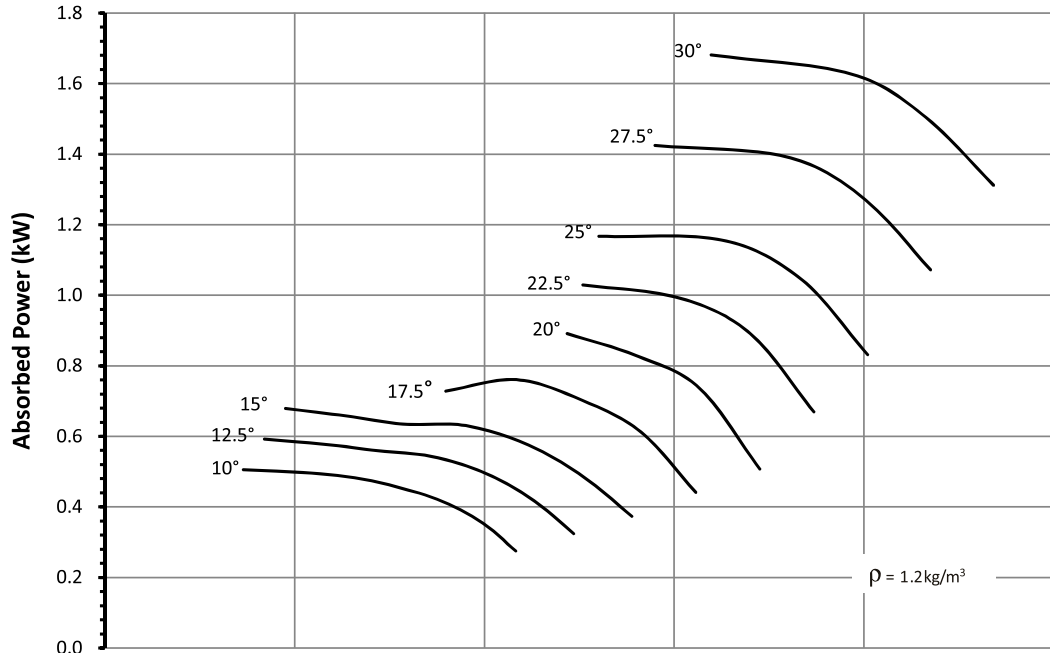

Ref	Full Octave Band Center Frequency								L _W A
	63	125	250	500	1K	2K	4K	8K	
a	74	80	79	77	75	76	68	57	81
b	74	79	78	76	77	76	69	59	81
c	75	83	83	84	79	73	65	57	84
d	78	86	85	77	73	69	65	60	80
e	75	85	84	79	76	76	69	60	82
f	74	83	82	78	76	75	69	61	82
g	75	82	84	83	81	77	70	63	85
h	80	86	88	86	81	76	70	64	87
j	77	86	85	80	76	75	81	88	89
k	76	85	84	79	76	74	80	89	89
m	76	84	83	80	77	74	80	88	89
n	88	87	88	86	81	76	76	77	88



Performance certified is for Installation type D: Ducted Inlet- Ducted Outlet. Performance ratings do not include the effects of appurtenances (accessories) Power rating kW is fan input power. The Sound Power Level ratings shown are in decibels, referred to 10-12 watts, calculated per AMCA International Standard 301. Values shown are for inlet L_Wi and L_WA sound power levels for Installation type D: Ducted Inlet-Ducted Outlet. Ratings include the effects of duct end correction. The A-weighted sound ratings shown have been calculated per AMCA International Standard 301.

Performance Curve FEG 60

ADTA 900-400-08
ADTA-F 900-400-08

60Hz 864 rpm

Outlet Area: 0.636 m²

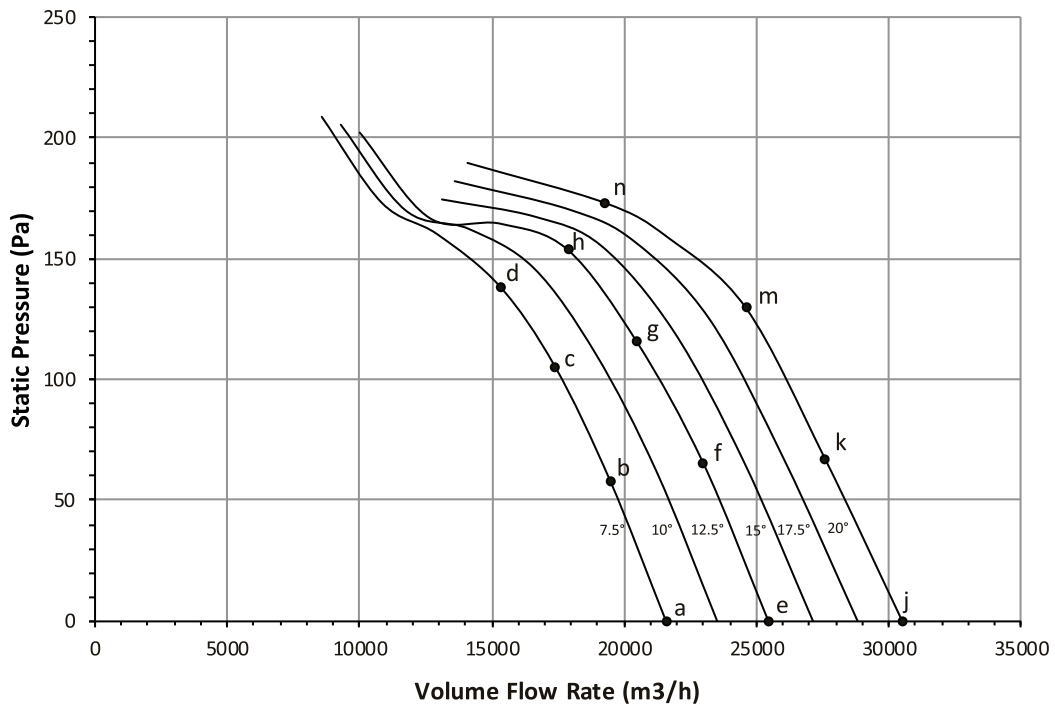
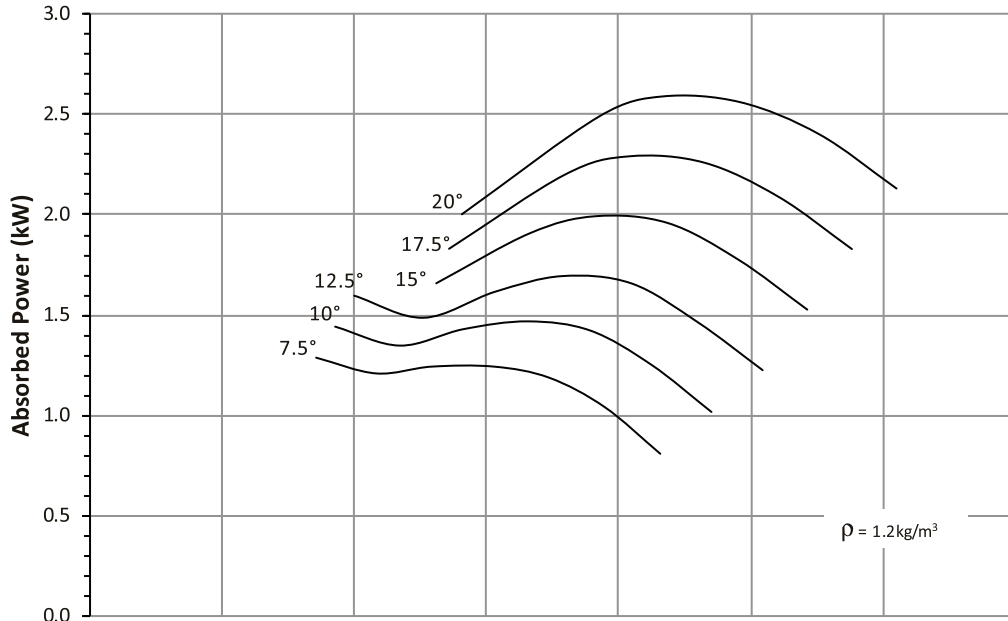

Ref	Full Octave Band Center Frequency								L _w A dB(A)
	63	125	250	500	1K	2K	4K	8K	
a	77	82	83	79	75	74	71	67	82
b	76	80	83	80	76	74	69	64	82
c	78	81	85	83	80	77	72	65	85
d	83	87	90	89	85	79	72	65	90
e	78	83	84	80	76	74	70	66	83
f	79	82	83	80	77	74	69	63	82
g	81	83	85	83	80	77	72	66	85
h	84	90	91	89	84	79	73	67	90
j	82	87	86	83	79	75	70	64	85
k	84	87	89	83	80	75	71	66	86
m	84	86	85	83	80	77	73	69	85
n	87	90	89	87	83	80	76	72	89



Performance certified is for Installation type D: Ducted Inlet- Ducted Outlet. Performance ratings do not include the effects of appurtenances (accessories). Power rating kW is fan input power. The Sound Power Level ratings shown are in decibels, referred to 10⁻¹² watts, calculated per AMCA International Standard 301. Values shown are for inlet L_w and L_wA sound power levels for Installation type D: Ducted Inlet-Ducted Outlet. Ratings include the effects of duct end correction. The A-weighted sound ratings shown have been calculated per AMCA International Standard 301.

Performance Curve
FEG 75

ADTA 1000-250-06
ADTA-F 1000-250-06

60Hz 864 rpm
Outlet Area: 0.785 m²

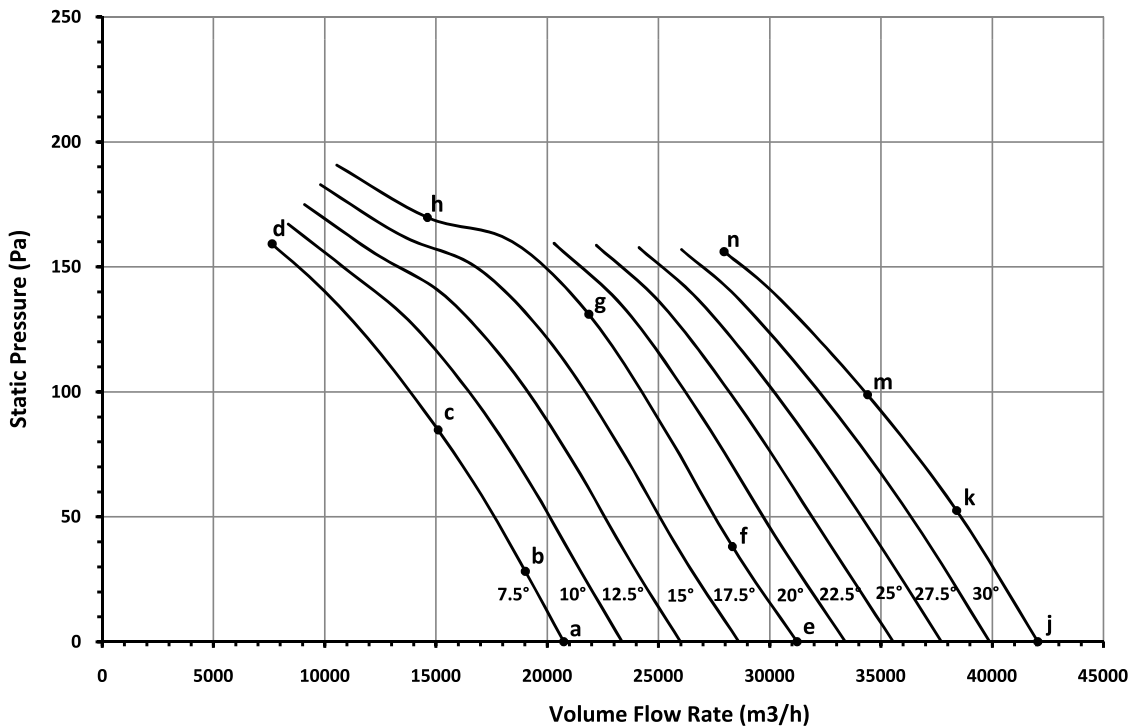
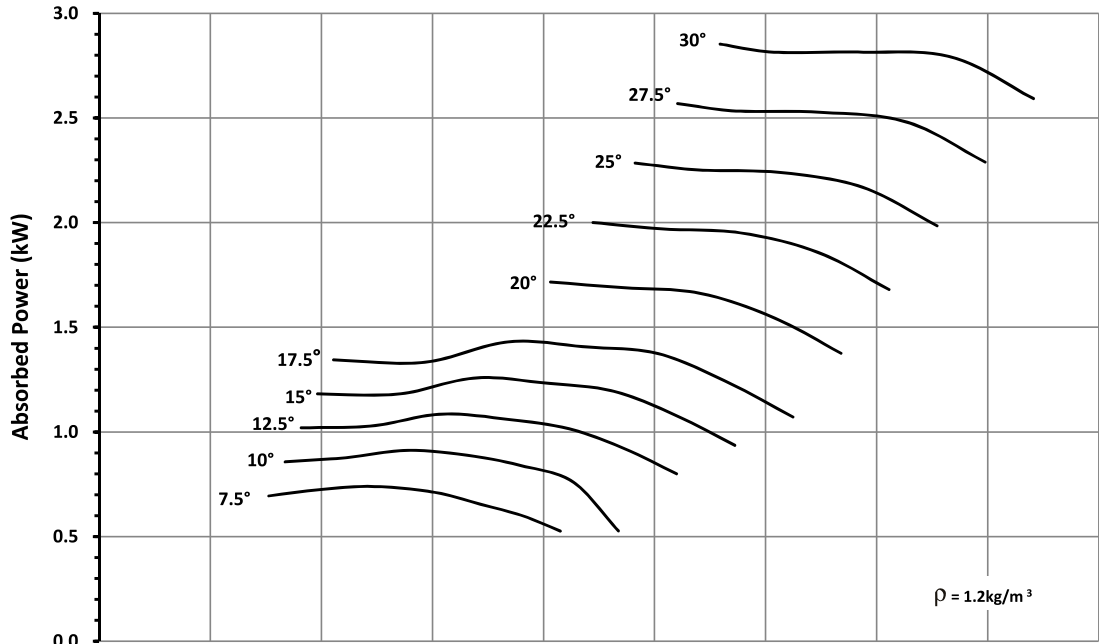

Ref	Full Octave Band Center Frequency								L _W /A dB(A)
	63	125	250	500	1K	2K	4K	8K	
a	77	81	82	82	79	79	75	70	85
b	77	79	81	83	81	80	76	71	87
c	76	78	86	88	85	80	73	66	89
d	83	94	93	87	81	76	71	65	89
e	81	83	84	82	78	78	76	73	85
f	79	81	83	81	79	76	73	69	84
g	79	82	89	89	85	80	75	70	90
h	81	91	98	95	88	82	75	69	95
j	84	87	88	86	82	79	77	75	88
k	84	87	87	86	82	79	77	75	88
m	83	86	86	85	83	80	78	76	88
n	84	87	89	88	85	81	79	77	90



Performance certified for Installation type D: Ducted Inlet- Ducted Outlet. Performance ratings do not include the effects of appurtenances (accessories) Power rating kW is fan input power. The Sound Power Level ratings shown are in decibels, referred to 10⁻¹² watts, calculated per AMCA International Standard 301. Values shown are for inlet L_W and L_W/A sound power levels for Installation type D: Ducted Inlet-Ducted Outlet. Ratings include the effects of duct end correction. The A-weighted sound ratings shown have been calculated per AMCA International Standard 301.

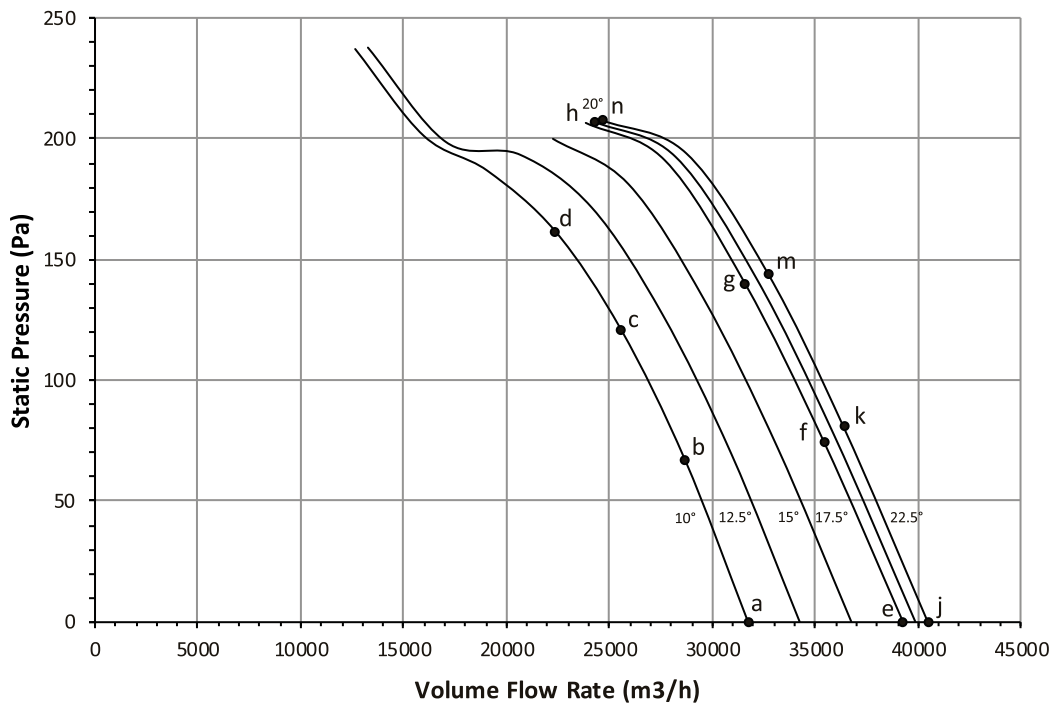
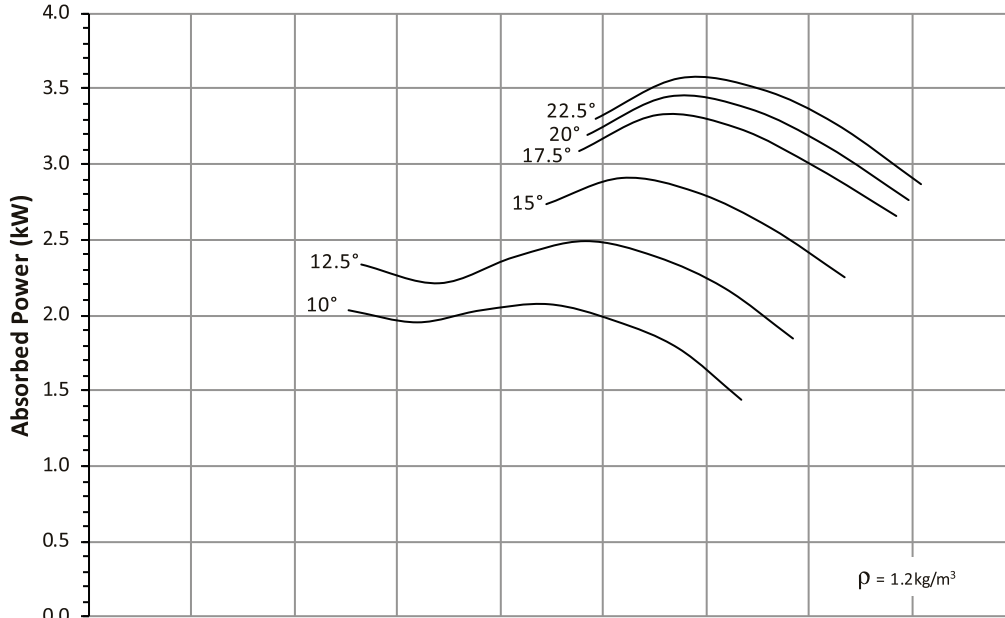

Ref	Full Octave Band Center Frequency								L _w A dB(A)
	63	125	250	500	1K	2K	4K	8K	
a	80	85	85	83	79	77	76	74	86
b	81	84	85	83	80	78	75	71	86
c	82	86	88	88	85	82	77	71	90
d	86	94	94	94	89	83	77	71	94
e	83	87	87	85	81	79	75	70	87
f	83	87	87	84	80	79	75	70	87
g	84	88	88	86	83	81	77	73	89
h	91	101	98	94	90	85	79	74	96
j	83	87	87	85	81	79	75	70	87
k	84	87	87	84	81	80	75	69	87
m	84	88	88	86	84	81	77	73	89
n	91	101	98	93	89	84	79	74	95



Performance certified is for Installation type D: Ducted Inlet- Ducted Outlet. Performance ratings do not include the effects of appurtenances (accessories) Power rating kW is fan input power. The Sound Power Level ratings shown are in decibels, referred to 10⁻¹² watts, calculated per AMCA International Standard 301. Values shown are for inlet L_{wi} and L_wA sound power levels for Installation type D: Ducted Inlet-Ducted Outlet. Ratings include the effects of duct end correction. The A-weighted sound ratings shown have been calculated per AMCA International Standard 301.

Performance Curve FEG 71

ADTA 1120-400-08
ADTA-F 1120-400-08

60Hz 864rpm

Outlet Area: 0.985 m²

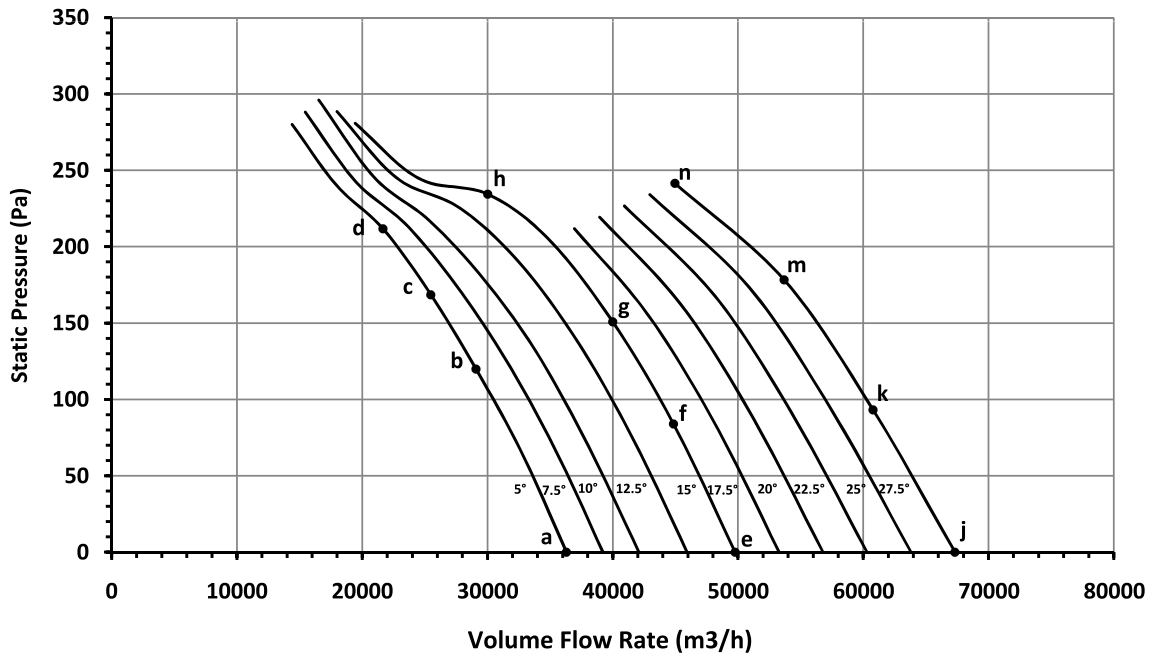
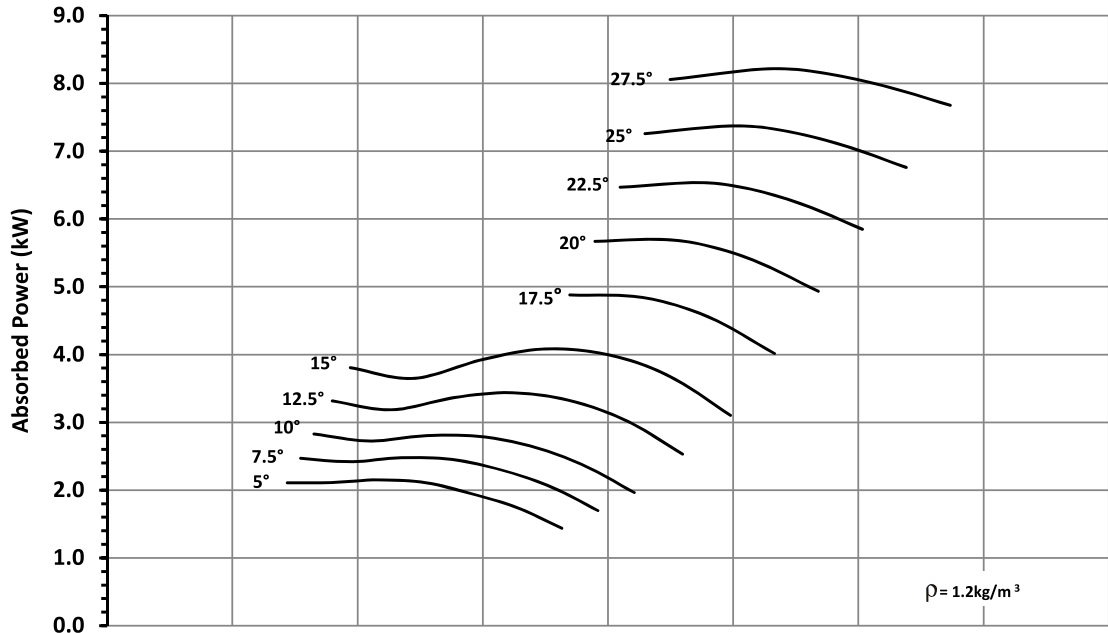

Ref	Full Octave Band Center Frequency								L _{wo} A dB(A)
	Hz								
	63	125	250	500	1K	2K	4K	8K	
a	81	84	87	86	83	81	80	80	89
b	80	87	92	94	92	87	81	74	96
c	84	94	94	94	90	85	79	72	95
d	89	96	95	93	88	83	78	72	94
e	86	90	88	87	83	80	78	76	89
f	84	88	87	86	83	82	78	74	89
g	87	91	91	91	88	86	82	77	93
h	100	101	97	94	90	86	80	74	96
j	98	93	91	91	87	84	82	79	93
k	101	94	91	91	88	85	83	80	93
m	98	94	90	90	88	85	84	81	93
n	97	99	96	94	92	87	83	79	96



Performance certified is for Installation type D: Ducted Inlet- Ducted Outlet. Performance ratings do not include the effects of appurtenances (accessories) Power rating kW is fan input power. The Sound Power Level ratings shown are in decibels, referred to 10⁻¹² watts, calculated per AMCA International Standard 301. Values shown are for outlet L_{wo} and L_{wo}A sound power levels for Installation type D: Ducted Inlet-Ducted Outlet. Ratings include the effects of duct end correction. The A-weighted sound ratings shown have been calculated per AMCA International Standard 301.

Performance Curve FEG 75

ADTA 1250-400-08
ADTA-F 1250-400-08

60Hz 864 rpm
Outlet Area: 1.227 m²

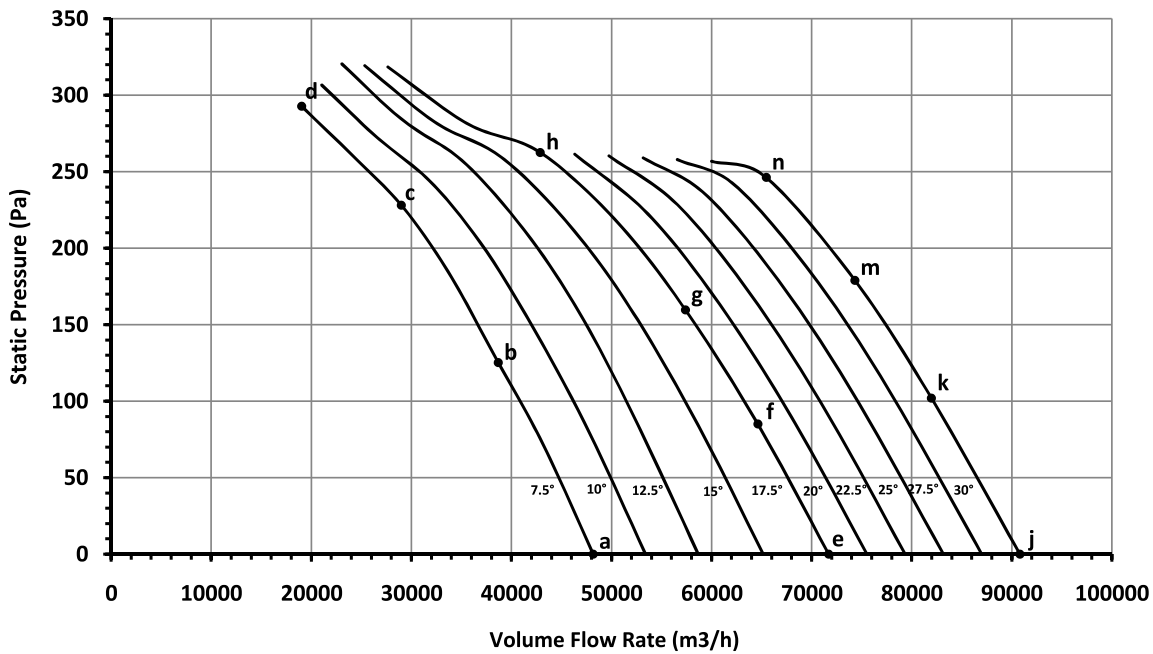
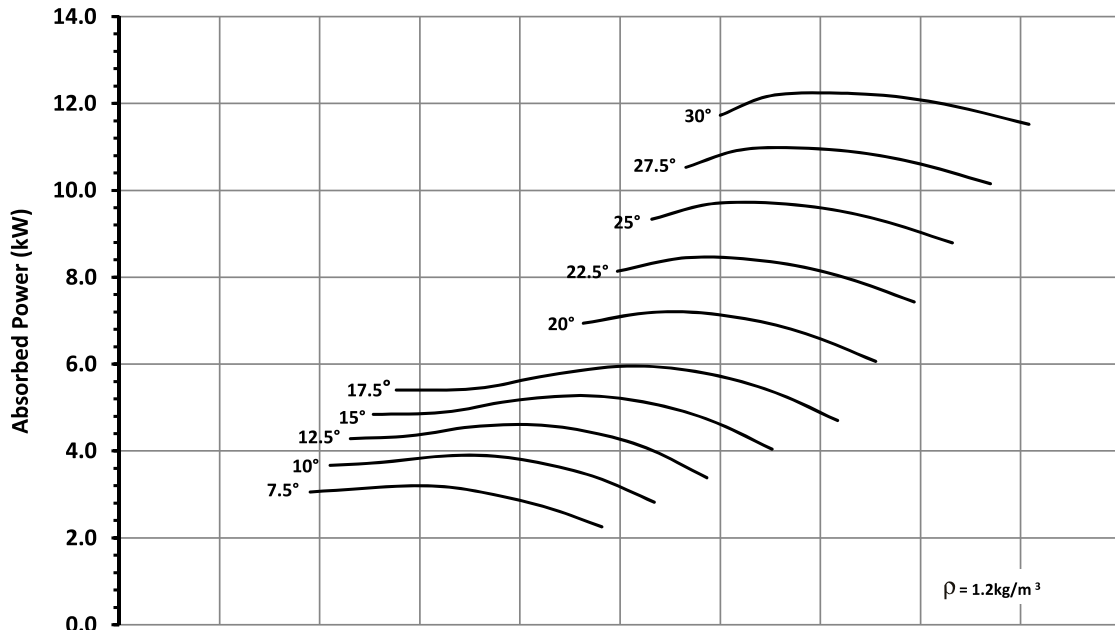

Ref	Full Octave Band Center Frequency								L _w A dB(A)
	63	125	250	500	1K	2K	4K	8K	
a	83	87	90	90	87	84	84	85	93
b	83	91	94	97	94	89	83	77	98
c	90	99	98	96	91	87	81	76	97
d	100	96	93	90	87	84	81	77	93
e	90	94	92	91	87	84	83	83	93
f	87	93	92	91	89	86	84	82	94
g	91	97	97	97	94	90	86	81	99
h	95	106	102	99	95	90	85	80	101
j	106	99	94	94	91	87	84	82	96
k	105	98	94	94	91	88	85	83	96
m	102	98	94	93	92	89	86	84	97
n	101	102	101	100	96	91	87	82	101



Performance certified is for Installation type D: Ducted Inlet- Ducted Outlet. Performance ratings do not include the effects of appurtenances (accessories) Power rating kW is fan input power. The Sound Power Level ratings shown are in decibels, referred to 10⁻¹² watts, calculated per AMCA International Standard 301. Values shown are for outlet L_{w0} and L_{w0}A sound power levels for Installation type D: Ducted Inlet-Ducted Outlet. Ratings include the effects of duct end correction. The A-weighted sound ratings shown have been calculated per AMCA International Standard 301.

Performance Curve FEG 75

ADTA 1250-400-12
ADTA-F 1250-400-12

60Hz 864rpm

Outlet Area: 1.227 m²

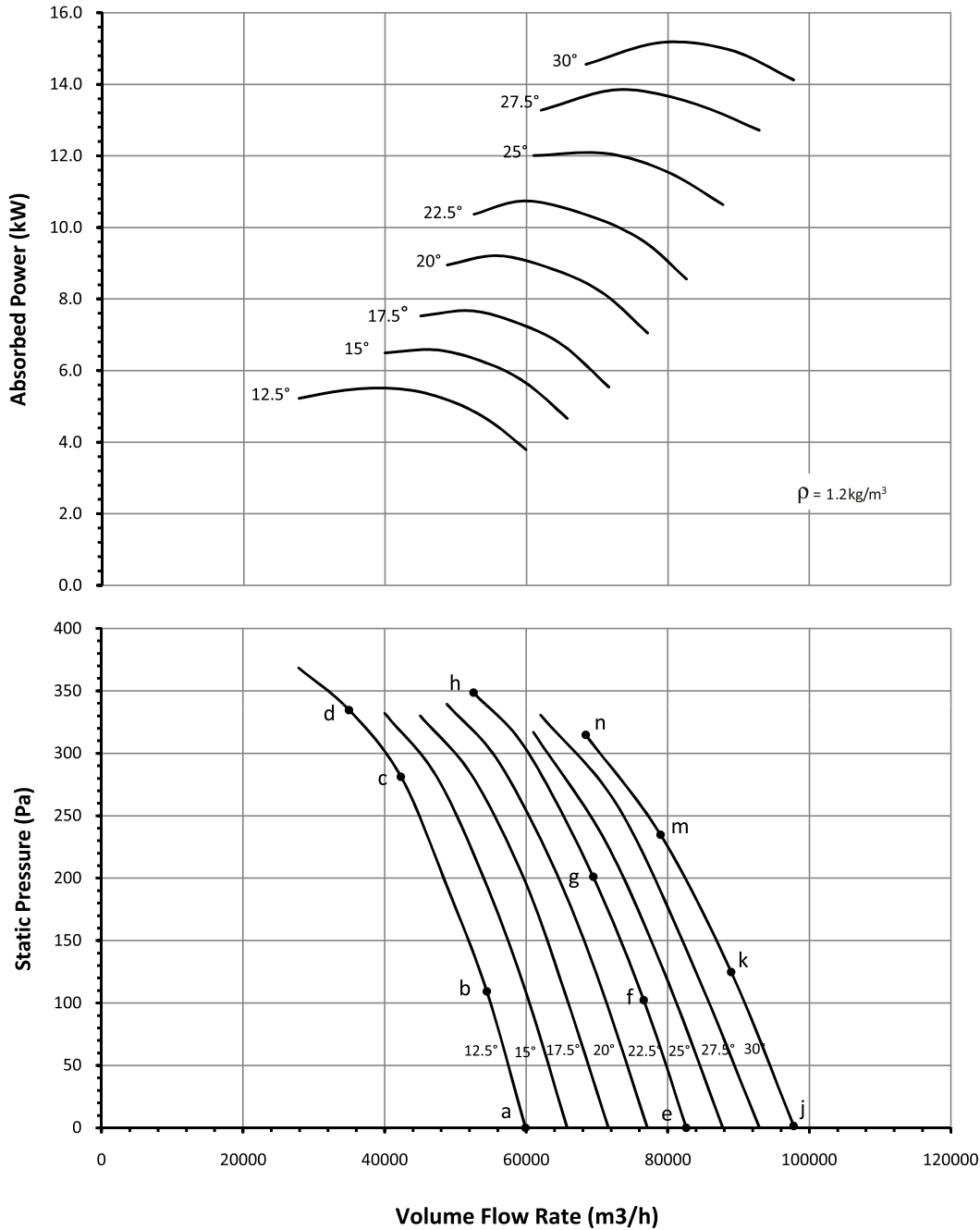

Ref	Full Octave Band Center Frequency								L _{WA} dB(A)
	63	125	250	500	1K	2K	4K	8K	
a	93	94	94	91	90	88	87	80	97
b	92	93	93	91	92	90	87	80	98
c	90	103	102	98	95	90	84	77	102
d	95	107	106	97	94	89	84	78	103
e	98	96	96	92	90	87	85	82	97
f	99	95	95	92	90	87	85	82	97
g	96	95	95	93	92	89	86	82	99
h	97	103	102	100	97	92	87	82	102
j	100	97	97	93	92	88	85	83	99
k	102	96	96	94	92	89	86	84	99
m	98	98	98	96	94	91	88	85	101
n	101	107	102	101	99	94	89	84	103



Performance certified is for Installation type D: Ducted Inlet- Ducted Outlet. Performance ratings do not include the effects of appurtenances (accessories) Power rating kW is fan input power. The Sound Power Level ratings shown are in decibels, referred to 10-12 watts, calculated per AMCA International Standard 301. Values shown are for outlet L_w and L_wA sound power levels for Installation type D: Ducted Inlet-Ducted Outlet. Ratings include the effects of duct end correction. The A-weighted sound ratings shown have been calculated per AMCA International Standard 301.

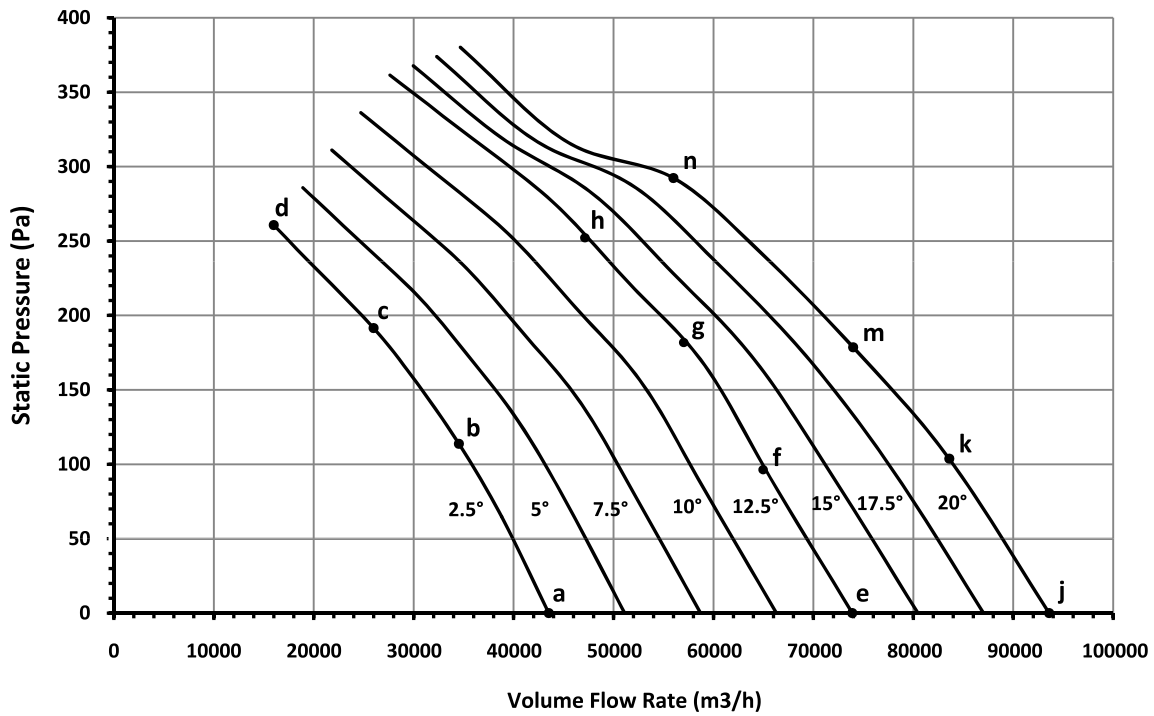
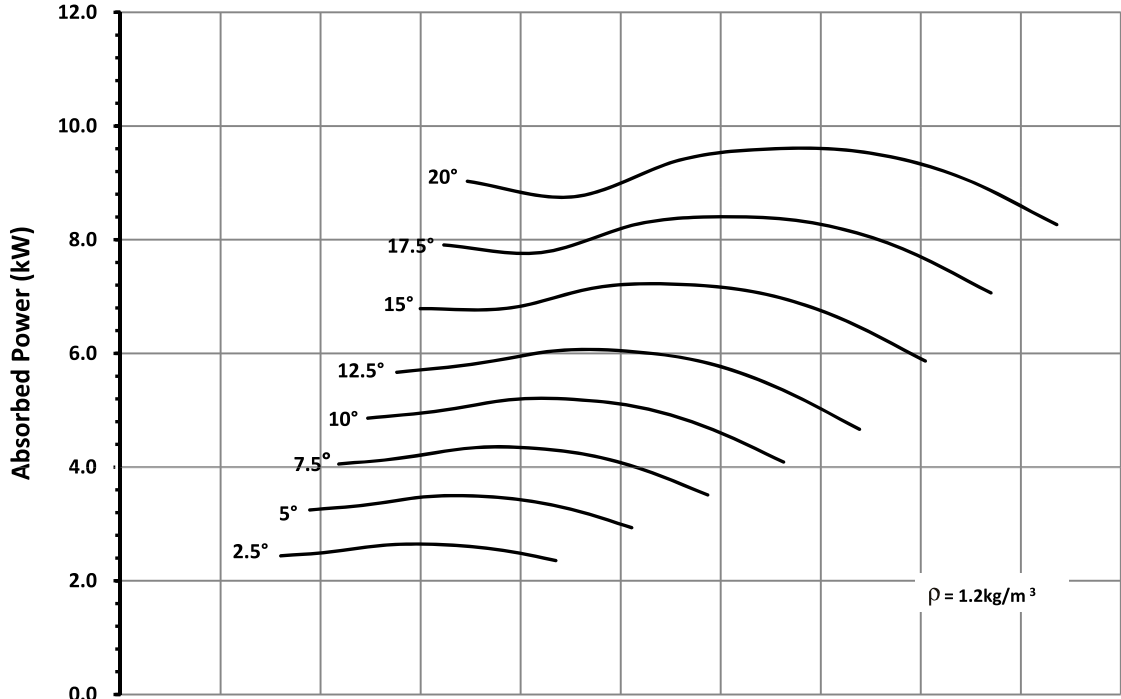

Ref	Full Octave Band Center Frequency								L _w A dB(A)
	63	125	250	500	1K	2K	4K	8K	
a	87	89	94	96	94	91	88	78	98
b	87	94	98	97	93	89	85	76	98
c	90	98	96	93	90	87	82	75	96
d	93	94	91	88	87	85	82	76	92
e	90	90	90	94	96	94	90	82	100
f	90	90	92	94	96	94	89	81	100
g	90	93	97	98	97	93	88	81	101
h	90	101	101	99	96	91	87	82	101
j	93	96	93	94	96	94	89	82	100
k	91	95	96	97	98	94	89	84	102
m	92	96	100	101	99	94	90	84	103
n	105	103	101	97	95	92	88	83	100



Performance certified is for Installation type A: Free Inlet-Free Outlet. Performance ratings do not include the effects of appurtenances (accessories)
Power rating kW is fan input power.
The Sound Power Level ratings shown are in decibels, referred to 10⁻¹² watts, calculated per AMCA International Standard 301. Values shown are for outlet L_{w0} and L_{wA} sound power levels for Installation type A: Free Inlet - Free Outlet.
The A-weighted sound ratings shown have been calculated per AMCA International Standard 301.

Performance Curve FEG 60

ADTA 1400-400-12
ADTA-F 1400-400-12

60Hz 864 rpm

Outlet Area: 1.550 m²

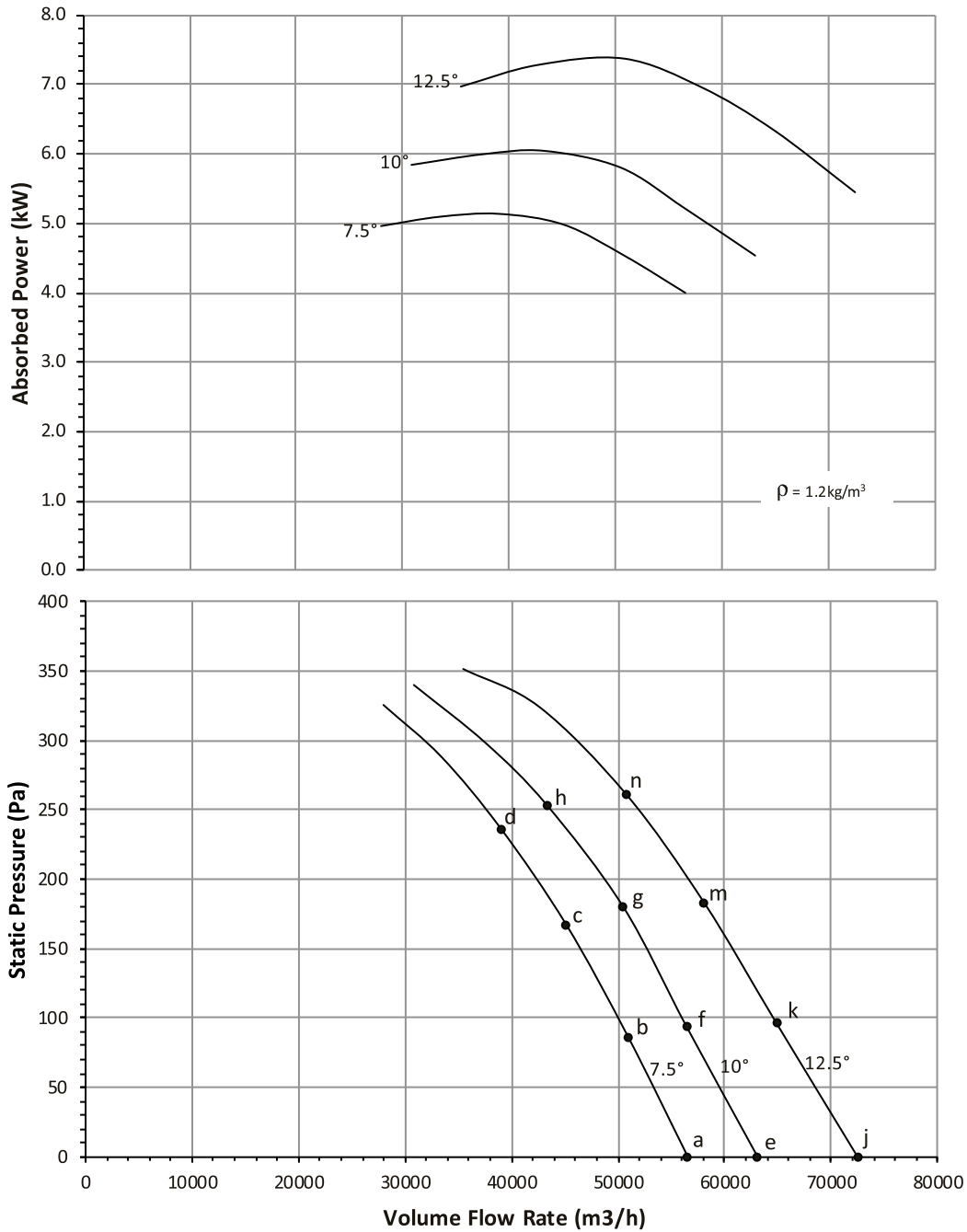

Ref	Full Octave Band Center Frequency								L _w /A dB(A)
	63	125	250	500	1K	2K	4K	8K	
a	85	93	94	97	97	93	90	81	101
b	86	96	97	99	98	93	88	80	102
c	89	99	100	100	97	92	87	78	102
d	90	101	101	99	96	91	86	77	101
e	88	93	94	97	98	94	91	82	101
f	90	97	97	100	99	94	89	81	102
g	90	101	100	101	98	93	88	79	102
h	91	101	101	99	97	92	87	78	101
j	88	92	93	96	98	96	92	83	102
k	89	97	97	100	99	95	89	81	103
m	91	103	101	102	99	94	88	80	103
n	93	103	102	100	98	93	88	79	102



Performance certified for Installation type A: Free Inlet - Free Outlet. Performance ratings do not include the effects of appurtenances (accessories). Power rating kW is fan input power. The Sound Power Level ratings shown are in decibels, referred to 10⁻¹² watts, calculated per AMCA International Standard 301. Values shown are for outlet L_w and L_w/A sound power levels for Installation type A: Free Inlet - Free Outlet. The A-weighted sound ratings shown have been calculated per AMCA International Standard 301.

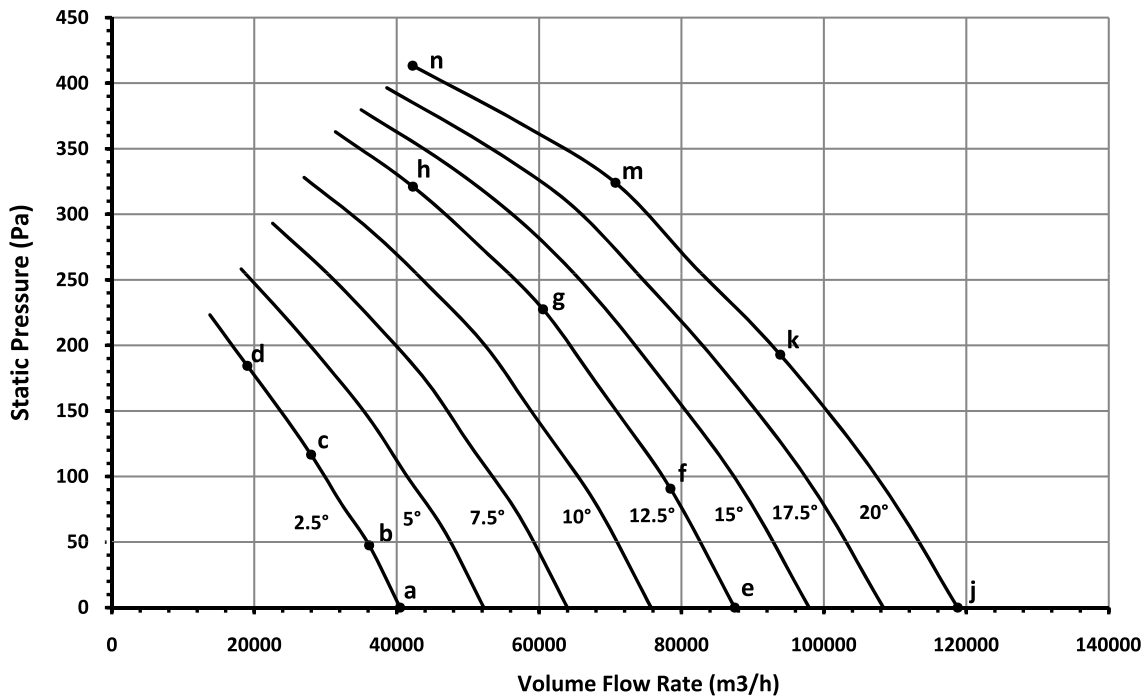
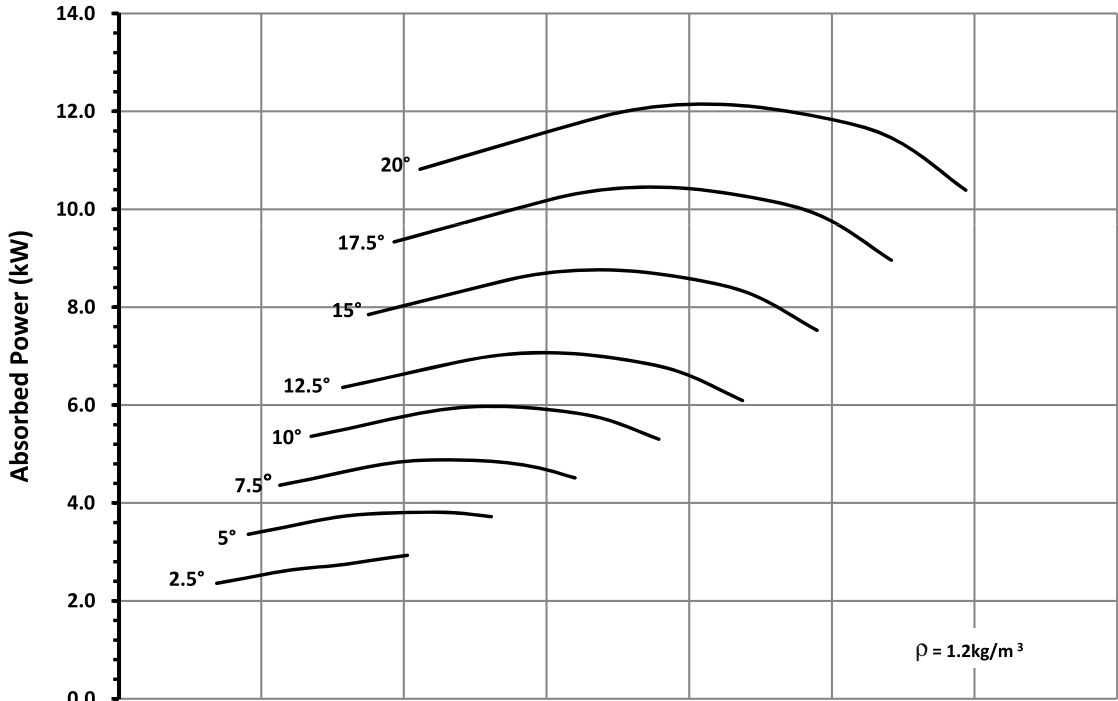

Ref	Full Octave Band Center Frequency								L _{w0A} dB(A)
	63	125	250	500	1K	2K	4K	8K	
a	94	98	99	98	96	92	89	81	101
b	93	97	98	97	96	92	89	80	100
c	92	94	94	94	94	91	88	81	98
d	93	94	93	93	93	90	89	83	98
e	92	94	97	99	100	96	93	84	104
f	91	96	99	101	99	95	91	82	103
g	89	97	101	100	97	92	88	81	102
h	93	100	99	96	93	90	87	82	99
j	95	95	96	99	101	97	94	86	104
k	95	97	101	103	101	96	91	85	105
m	93	100	102	102	99	95	91	86	104
n	99	100	99	97	95	93	90	87	101



Performance certified is for Installation type A: Free Inlet-Free Outlet. Performance ratings do not include the effects of appurtenances (accessories)
Power rating kW is fan input power.
The Sound Power Level ratings shown are in decibels, referred to 10⁻¹² watts, calculated per AMCA International Standard 301. Values shown are for outlet L_{w0} and L_{w0A} sound power levels for Installation type A: Free Inlet - Free Outlet. The A-weighted sound ratings shown have been calculated per AMCA International Standard 301.

Performance Curve FEG 56

ADTA 1600-400-16
ADTA-F 1600-400-16

60Hz 864 rpm

Outlet Area: 2.023 m²

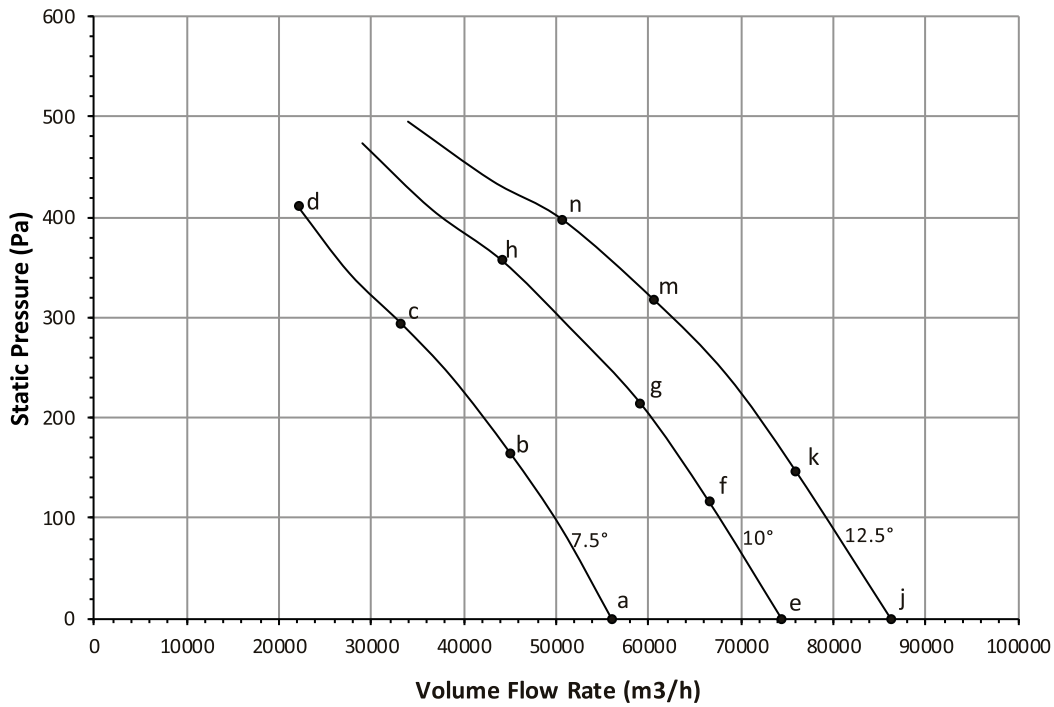
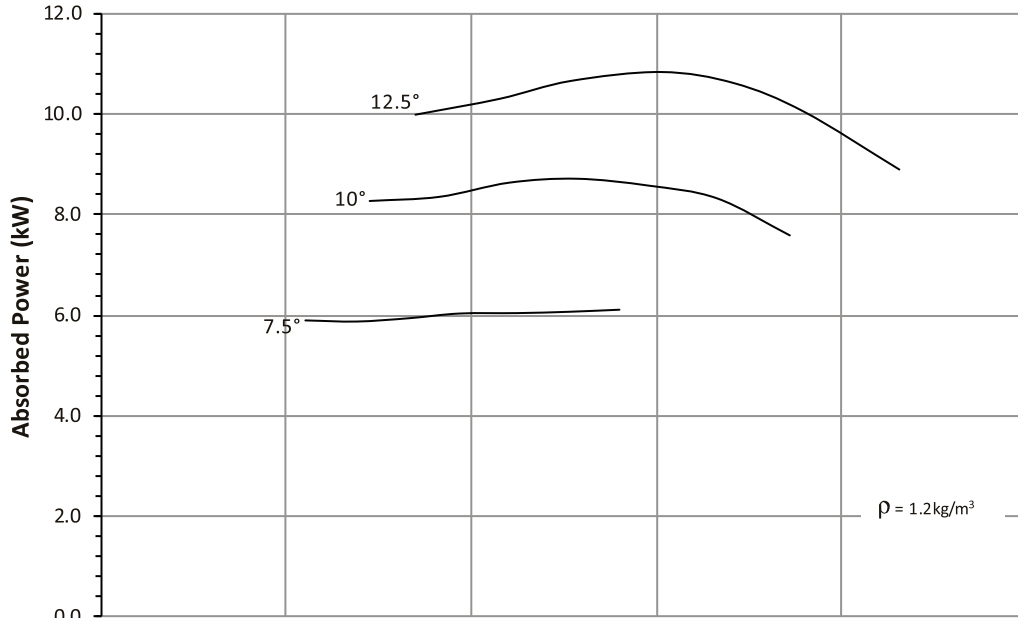

Ref	Full Octave Band Center Frequency								L _W A dB(A)
	63	125	250	500	1K	2K	4K	8K	
a	91	98	103	101	99	96	93	87	104
b	91	104	103	99	98	95	91	83	103
c	90	101	101	97	97	93	88	83	101
d	88	95	97	95	95	92	88	84	99
e	90	94	104	103	101	97	94	87	106
f	89	97	105	103	100	97	94	85	105
g	90	101	104	102	100	96	92	83	105
h	91	105	104	100	99	95	89	81	103
j	92	94	103	104	102	97	95	87	106
k	92	97	106	104	102	97	93	85	106
m	91	103	105	102	100	96	91	83	105
n	92	105	105	101	99	95	90	82	104



Performance certified is for Installation type A: Free Inlet-Free Outlet. Performance ratings do not include the effects of appurtenances (accessories)
Power rating kW is fan input power.
The Sound Power Level ratings shown are in decibels, referred to 10⁻¹² watts, calculated per AMCA International Standard 301. Values shown are for outlet L_W and L_WA sound power levels for Installation type A: Free Inlet - Free Outlet.
The A-weighted sound ratings shown have been calculated per AMCA International Standard 301.

Nomenclature

When ordering Nicotra Gebhardt Axial fans, please specify your requirements in the followings sequence to avoid confusion.

1. Fan Type and Performance Data
 - Fan Type: ADTA, ADTA-F
 - Capacity
 - Static Pressure

2. Electric Motor Details
 - Power, main supply, voltage, frequency, 50 Hz or 60 Hz type
 - Motor Speed, Polarity
 - Insulation (Class F, Class H, etc)

3. Impeller Material
 - Glass Reinforced Nylon, GRN
 - Aluminium, ALU
 - Anti Static GRN

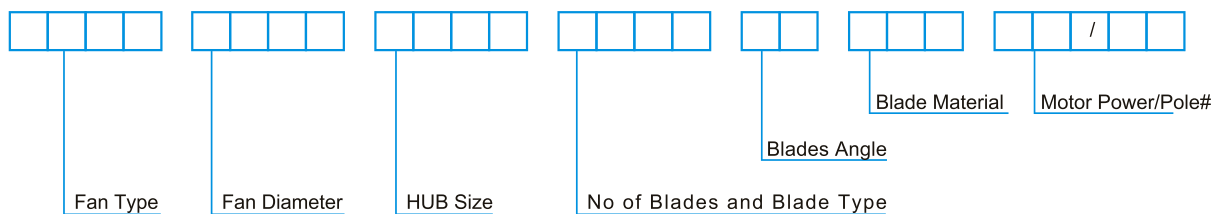

Description (Sample)

ADTA1000/400/08C/20.0/ALU-18.5/4P

ADTA	Long Case Drive
1000	Fan Diameter = 1000mm
400T	Hub Size
8C	Blade type C, Qty = 8
20°	Blade Angle 20 Deg
ALU	ALU Material



Appendix

Wiring Diagram For Various Application

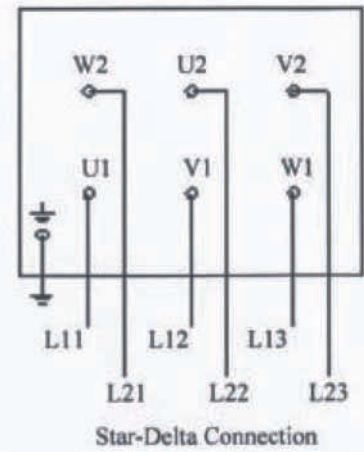
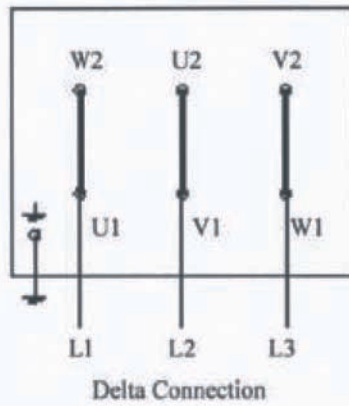
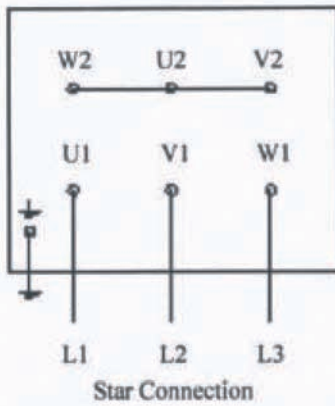

Multi-speed with 2 separate Windings

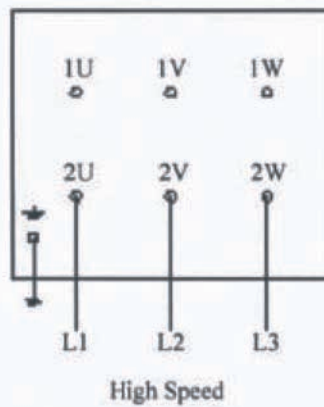
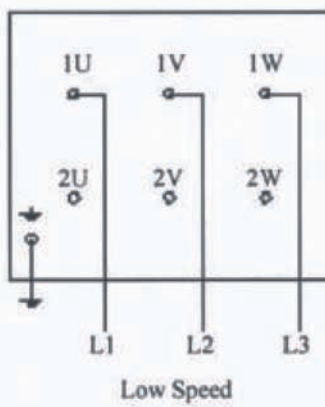

Multi-speed motors in Dahlander Connection (tapped winding)

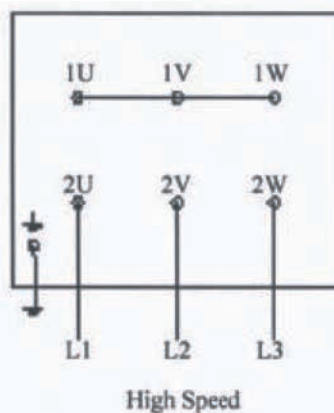
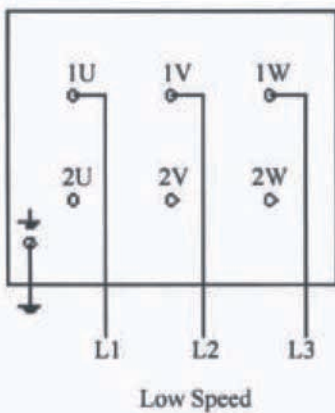

WORLDWIDE LOCATIONS

NICOTRA-GEBHARDT.COM

AUSTRALIA

Regal Beloit Australia Pty Ltd
Melbourne Office
19 Corporate Ave (PO Box 2340)
Rowville VIC 3178
Phone 1 300 888 853
Fax +61 3 9237 4050

BELGIUM

Nicotra Gebhardt Belgique
Allée des Artisan,18
4130 Esneux
Phone +32 (0)42288580
Fax +32 (0)42288580
E-mail info@nicotra.be

CHINA

Nicotra Gebhardt (Guangzhou) Co. Ltd. - China
88 Tai'An Road, XinQiao, ShiJi, Panyu
Guangzhou 511450
PR CHINA
Phone +86 (0)20-2293 5700
Fax +86 (0)20-2293 5701
E-mail sales@nicotra-china.com

FRANCE

Nicotra Gebhardt S.p.A.
Leader's Park Bat A1
3 chemin des Cytises
69340 Francheville
Phone +33 (0)4 72 79 01 20
Fax +33 (0)4 72 79 01 21
E-mail ngfrance@nicotra-gebhardt.com

GREAT BRITAIN

Nicotra Gebhardt Ltd - UK
Unit D, Rail Mill Way
Parkgate Business Park
Rotherham
South Yorkshire
S62 6JQ
Phone +044 01709-780760
Fax +044 01709-780762
E-mail sales@nicotra.co.uk

INDIA

Nicotra India PVT Ltd - India
Plot no 28F & 29, Sector-31,Kasna,
Greater Noida-201 308 U.P (India)
Phone +91 120 4783400
Phone +91 22 65702056 (Mumbai)
Phone +91 80 25727830 (Bangalore)
E-mail info@nicotraindia.com

NEW ZEALAND

Regal Beloit New Zealand Limited
Auckland office
18 Jomac Place
Avondale, Auckland 1026
Phone 0800 676722
Fax +64 9 820 8504



SPAIN

Nicotra Gebhardt Espana
C/ Jamaica, 5
Apdo. Correos 5077
28806 Alcalá de Henares
Phone +34 918-846110
Fax +34 918-859450
E-mail info.es@nicotra-gebhardt.com

SINGAPORE

Nicotra Gebhardt PTE LTD
12 Tuas Loop
Singapore 637346
Phone +65 6863 3473
Fax +65 6863 3476
E-mail info_singapore@nicotra-gebhardt.com

SWEDEN

Nicotra Gebhardt A.B
Box 237
Krakatorpsgratan 30
43153 Mölndal
Phone +46 (0)311302610
E-mail info.se@nicotra-gebhardt.com

THAILAND

Nicotra Gebhardt Co LTD
6/29 Soi Suksawadi 2, Moo 4, Suksawadi Road,
Kwang Jomthong, Khet Jomthong,
Bangkok 10150
Phone +662 476-1823-6
Fax +662 476-1827
E-mail sales@nicotra.co.th

UNITED STATES

Regal Beloit Corporation
200 State St.
Beloit, WI 53511
Phone 001(608) 364-8800
E-mail info.ng.us@regalbeloit.com
Web www.regalbeloit.com

NICOTRA|Gebhardt®

Nicotra Gebhardt Germany

Nicotra Gebhardt GmbH
Gebhardtstraße 19-25
74638 Waldenburg (Germany)
Phone +49 7942 1010
Fax +49 7942 101 170
E-Mail info.ng.de@regalbeloit.com
Web www.nicotra-gebhardt.com

Nicotra Gebhardt Italy

Regal Beloit Italy S.p.A.
Via Modena, 18
24040 Zingonia (BG) (Italy)
Phone +39 035 873 111
Fax +39 035 884 319
E-mail info.ng.it@regalbeloit.com
Web www.nicotra-gebhardt.com

APPLICATION CONSIDERATIONS

The proper selection and application of products and components, including the related area of product safety, is the responsibility of the customer. Operating and performance requirements and potential associated issues will vary appreciably depending upon the use and application of such products and components. The scope of the technical and application information included in this publication is necessarily limited. Unusual operating environments and conditions, lubrication requirements, loading supports, and other factors can materially affect the application and operating results of the products and components and the customer should carefully review its requirements. Any technical advice or review furnished by Regal Beloit America, Inc. and/or its affiliates ("Regal Rexnord Corp") with respect to the use of products and components is given in good faith and without charge, and Regal Rexnord Corp assumes no obligation or liability for the advice given, or results obtained, all such advice and review being given and accepted at customer's risk.

For a copy of our Standard Terms and Conditions of Sale, please visit <https://www.regalbeloit.com/Terms-and-Conditions-of-Sale>. These terms and conditions of sale, disclaimers and limitations of liability apply to any person who may buy, acquire or use a Regal Rexnord Corp product referred to herein, including any person who buys from a licensed distributor of these branded products.

Regal
Rexnord