

AXIAL FAN SERIES

ADTA • ADTA-F

NICOTRA | Gebhardt



Nicotra Gebhardt (Guangzhou) Co. Ltd. certifies that the ADTA and ADTA-F Series shown herein are licensed to bear the AMCA Seal.

The ratings shown are based on tests and procedures performed in accordance with AMCA Publication 211 and AMCA Publication 311 and comply with the requirements of the AMCA Certified Ratings Program.

fan|tastic solutions

AXIAL FAN ADTA/EN/50HZ/OCTOBER/2022



Introduction

The Nicotra Gebhardt axial fan provide wide range of air volume from 360 m³/hr to 216,000 m³/hr, at static pressure up to 1000 Pa of complete fan system with most diversified application. Remarkably high fan efficiencies are the direct result of rigorously developed aerodynamically profiled impeller blades and advanced manufacturing technique.

FEATURES

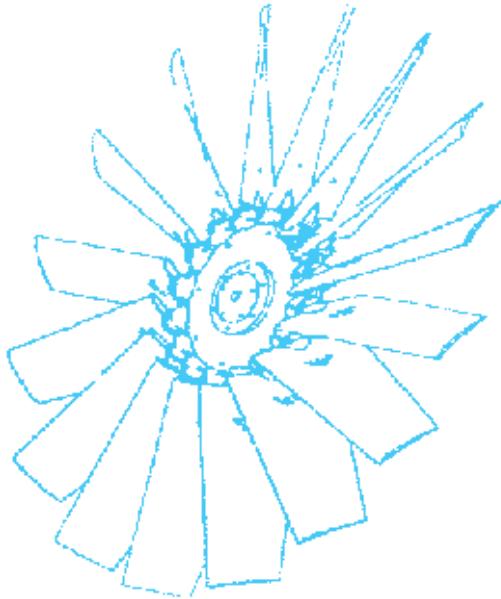

- High Efficiency
- Fully Adjustable Blade
- Versatile
- High Quality Material
- Interchangeable Components
- The Axial Impeller Is Balanced In Line ISO 1940, G2.5
- Robust Construction
- GRN and Pressure Die Cast Aluminium Material
- Anti-static GRN for Anti Spark Application
- Third Party Certification On BS EN 12101-3:2015 For Smoke Spill Application
- Series ADTA is AMCA Certified For Air and Sound Performance.
- AMCA Licensed for Air Performance, Sound and FEG

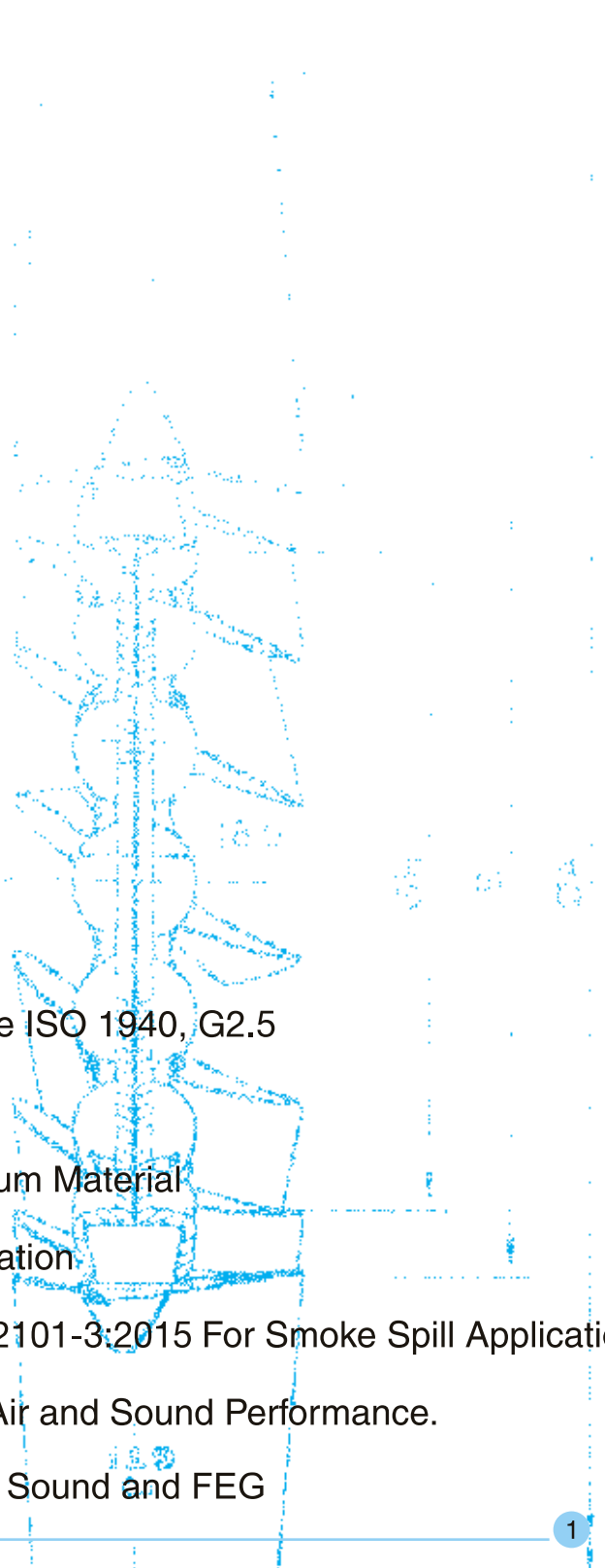

Balancing

All Nicotra Gebhardt axial impellers and fans are balanced to ISO Std No 1940, Edition using balancing grade of G2.5 (Displacement Amplitude = 2.5 mm/s) in our factory.

Hub System

Our range of axial fan is fully adjustable blades and there are basically 6 hubs systems as shown below:

Hub Size	Number of Blades
110	5 Blades
160	5 & 10 Blades
230	3, 6 & 12 Blades
250	3, 6 & 12 Blades
400	4, 8, 12 & 16 Blades
550	4, 7 & 11 Blades

Hub Combination for Axial Fan

The complete hub system for impeller 1400 and 1600 consists of side plate metal, center hub, aluminium blade, blade holder and taper lock bush.

Our 250 and 400 hub are designed to be mounted with taper-lock bush 2517 of 42mm, 48mm, 55mm and 60mm diameter as optional feature.

Blades Design / Types

Basically, we have the following design of impellers:

Design Type	Material	Hub System
B	ALU	110, 160, 230
T	ALU	250
C	ALU	400

Casing Surface Finishing

All standard axial fan tube casing's surface are applied with paint - RAL 7039 by powder coating method. Coating thickness is 60µm.

Thus, by this method, tube casing surface appeared to be wrinkle and provide better protection against chemical and wear.

Long case axial casings are rolled from 2.0 mm to 5.0 mm mild steel. The standard double flanged L bracket mounting is provided, foot mounted support can be provided as optional. Tube casing come with standard view port, and the access door can be requested as option.

Electric Motor

Nicotra Gebhardt use standard three phase motors TEFC, foot mounted insulation in accordance with IEC standard EN 60034, Enclosure IP55, insulation Class "F". Other medium temperatures, protection classes, two speed motor (poles switch) and etc as optional.

Computer selection

Our user-friendly fan selection software allows you to select the most suitable model to your needs. Performance data and fan curve will be generated by the state of art software.

ADTA Series

APPLICATION

Nicotra Gebhardt ADTA are particularly suitable for the extraction of stale air, for general ventilation, drying process and all those applications which require moving large volumes of air.

CONSTRUCTION

The housing is made of heavy-gauge mild steel casing, seamless double flanges at both end. Powder coated bake enamel finishing (60 micron) or galvanized steel. High efficiency impeller made of adjustable pitch aerofoil blade; ALU type or GRN type. Foot mounting & Hot dip galvanized casing is available as an option.



WORKING TEMPERATURE

-40°C to 150°C : GRN

-40°C to 200°C : ALU

MOTOR

Three-phase with type of “Totally Enclosed Fan Cooled” (TEFC), horizontal foot mounted Squirrel Cage Induction Motor, featured with class F insulation system with Class B temperature rise (80°C). Voltage supply includes 400V/50Hz, 400V/60Hz or 440V/60Hz. Motor Standards are comply with IEC 60034 or BS 4999. Other requirements upon demand basis.

Motor are wired to an external terminal box with cable and through PVC or steel flexible conduit.

DIRECTION OF THE AIR

The standard air flow from the impeller to the motor (B), on demand the fans can be supplied with the direction from the motor to the impeller (A).

Air Performance

Air performance ratings of the ADTA fans described by ADTA catalogue have been derived from performance tests made with installation type “A (Free inlet & Free outlet) & D (with ducted inlet and ducted outlet)”. These tests were carried out in accordance with AMCA standard 210-16 (Fig. 12, and Fig. 15). Ratings are referred to the standard air density.

Sound Power Level

Noise ratings are calculated starting from sound power level measurements made in accordance with the AMCA standard 300-14, (Fig. 2D and Fig. 3D). The test results keep into consideration the presence of the motor inside the fan.



Nicotra Gebhardt (Guangzhou) Co. Ltd.

certifies that the ADTA and ADTA-F Series shown herein are licensed to bear the AMCA Seal.

The ratings shown are based on tests and procedures performed in accordance with AMCA Publication 211 and AMCA Publication 311 and comply with the requirements of the AMCA Certified Ratings Program.

ADTA-F Series

APPLICATION

Nicotra Gebhardt ADTA-F smoke spill axial fans are particularly designed for the removal of hot toxic smoke so as to remove the smoke at the escape passage and assist firefighters by providing better visibility. It also provide ventilation to the area during normal situation.

CONSTRUCTION

The housing is made of heavy-gauge mild steel casing, seamless double flanges at both end. Powder coated bake enamel finishing or galvanized steel. High efficiency impeller made of adjustable pitch aerofoil blade pressure die cast Aluminium. Hot dip galvanized casing is available as option.

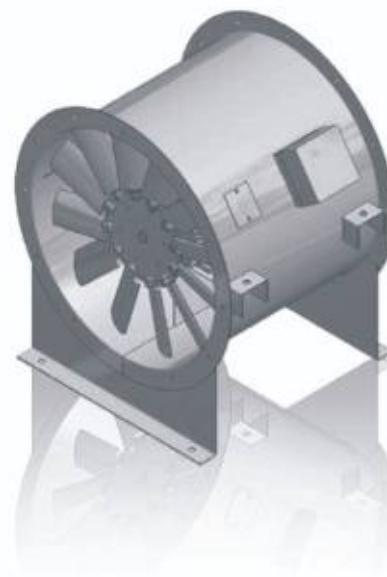

MOTOR

High temperature resistance motor compliance to BS 7346 : Part2 : 1990 and EN 12101-3 : 2006 directive. Three phase with type of “Totally Enclosed Air Over” (TEAO), horizontal foot mounted Squirrel Cage Induction Motor, featured with class H insulation system with Class B temperature rise (80°C). Voltage supply includes 400V/50Hz, 400V/60Hz or 440V/60Hz. Motor Standards are comply with IEC 60034 or BS 4999. Other requirements upon demand basis.

Motor are wired to an external terminal box with cable and through flexible conduit.

TESTING

ADTA-F axial fans have been tested in accordance to BS EN 12101-3:2015

This series have been tested under below classification:

Temperature (deg.C)	Period (minutes)	Test Body
250	120	TUV SUD
316	240	TUV SUD
400	120	SGS

DIRECTION OF THE AIR

The standard air flow from the impeller to the motor (B), on demand the fans can be supplied with the direction from the motor to the impeller (A)

ADTA, ADTA-F General Dimension

ADTA, ADTA-F with Hanger

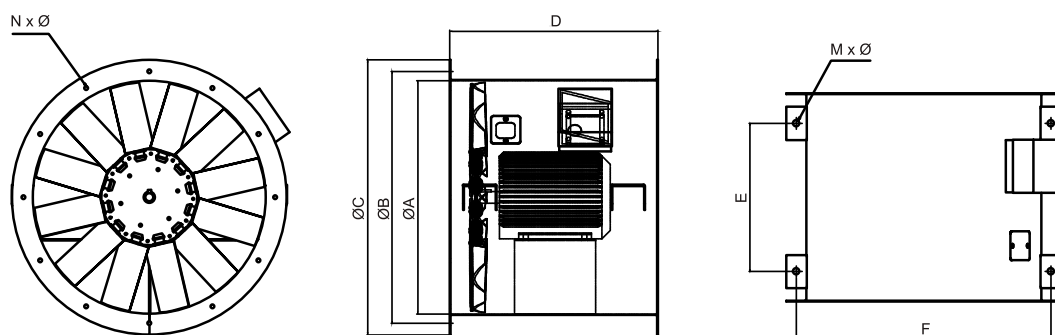

ADTA, ADTA-F with Mounting Feet (optional)

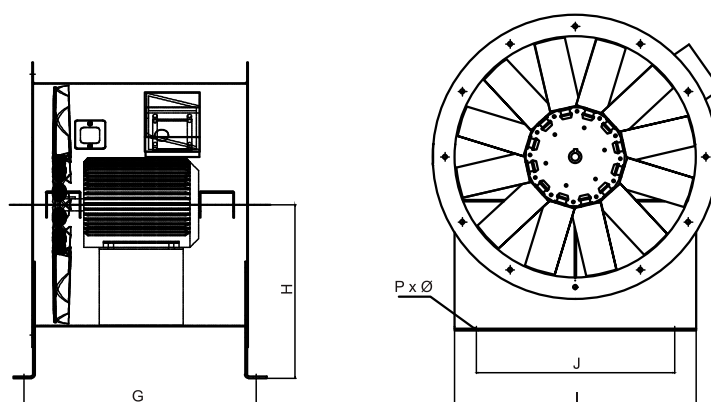

MODEL	ADTA/ADTA-F General Dimensions					ADTA/ADTA-F - Hanger			ADTA/ADTA-F - Mounting Feet (Optional)					Mtr Frame Size
	ØA	ØB (PCD)	ØC	D	N x Ø	E	F	M x Ø	G	H	I	J	P x Ø	
315	315	355	395	355	8 X 10	211	365	4 X 16	395	277.5	265	315	2 x 10	90
400	400	440	480	355	12 X 10	211	450	4 X 16	395	320	350	400	2 x 10	90
400	400	440	480	435	12 X 10	291	450	4 X 16	475	320	350	400	2 x 10	112
500	500	540	580	500	12 X 10	356	550	4 X 16	538	370	450	500	2 x 14	132
560	560	605	660	500	12 X 10	356	611	4 X 16	538	402.5	460	560	2 x 14	132
630	630	675	730	500	12 X 10	326	691	4 X 20	538	437.5	530	630	2 x 14	112
630	630	675	730	700	12 X 10	526	691	4 X 20	738	437.5	530	630	2 x 14	160
710	710	755	810	500	18 X 12	324	774	4 X 20	536	477.5	610	710	2 x 16	112
710	710	755	810	710	18 X 12	534	774	4 X 20	746	477.5	610	710	2 x 16	160
800	800	845	900	560	18 X 12	384	864	4 X 20	596	522.5	700	800	2 x 16	132
800	800	845	900	760	18 X 12	584	864	4 X 20	796	522.5	700	800	2 x 16	180
900	900	945	1000	630	18 X 12	454	964	4 X 20	666	592.5	800	900	2 x 16	132
900	900	945	1000	820	18 X 12	644	964	4 X 20	856	592.5	800	900	2 x 16	200
1000	1000	1045	1100	630	24 X 12	454	1065	4 X 20	666	672.5	900	1000	2 x 16	160
1000	1000	1045	1100	800	24 X 12	624	1065	4 X 20	836	672.5	900	1000	2 x 16	200
1120	1120	1185	1250	900	24 X 12	724	1185	4 X 20	936	742.5	1020	1120	2 x 16	225
1120	1120	1185	1250	1150	24 X 12	974	1185	4 X 20	1186	742.5	1020	1120	2 x 16	280
1250	1250	1315	1380	1000	24 X 12	794	1324	4 X 25	1084	807.5	1050	1250	3 x 20	250
1250	1250	1315	1380	1150	24 X 12	944	1324	4 X 25	1234	807.5	1050	1250	3 x 20	280
1400	1400	1465	1530	1120	32 X 14	912	1476	4 X 25	1202	882.5	1200	1400	3 x 20	280
1600	1600	1663	1730	1250	32 X 14	1042	1676	4 X 25	1332	981.5	1400	1600	3 x 20	315

Due to a policy of continuous development and improvement the right is reserved to supply product which may differ from those illustrated and described in this publications.

Certified dimensions will be supplied on receipt of order

ADTA, ADTA-F Exploded View

Part List, Specification, Arrangement

Part Description	Specification
1 Tube Casing	Painted (RAL 7039), Hot Dipped, Stainless Steel, etc
2 Terminal Box	PVC, Cast Iron, etc
3 Viewport Cover	Depend on t/casing material
4 Mounting Feet (Optional)	Depend on t/casing material
5 Counter Flange (Optional)	Depend on t/casing material
6 Electrical Motor	Specification as per requested
7 Impeller	ALU, GRN, GRN-antistatic
8 Fan Guard	Painted or Hot Dipped

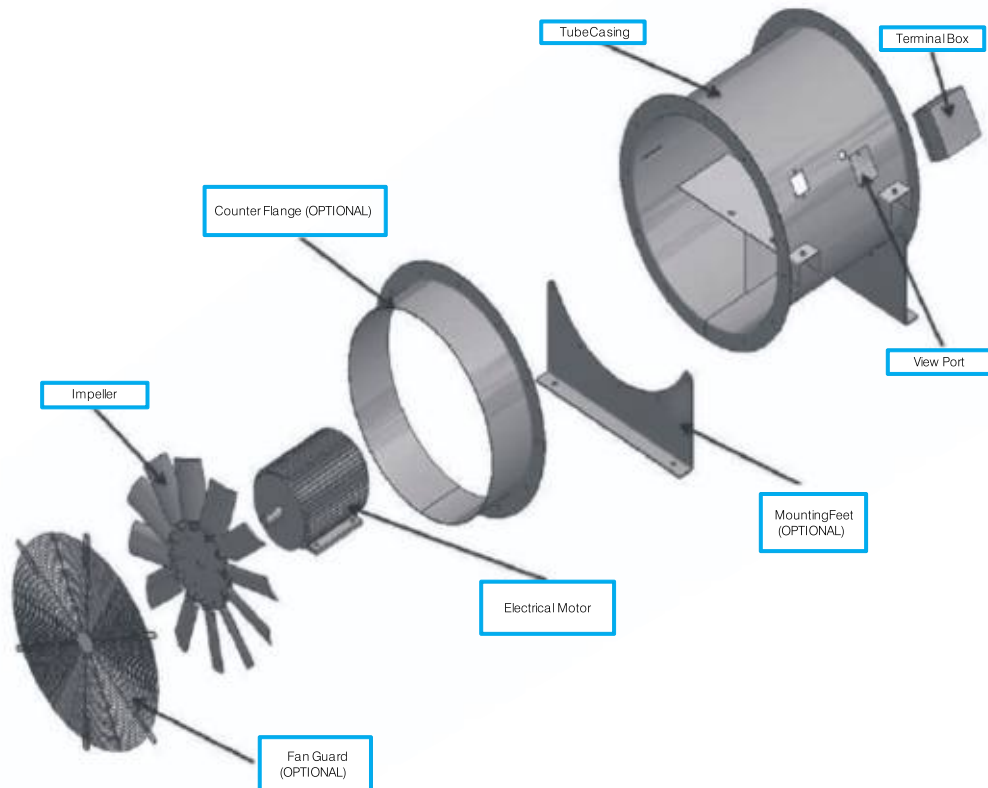

AXIAL COUNTER FLANGE (OPTIONAL)

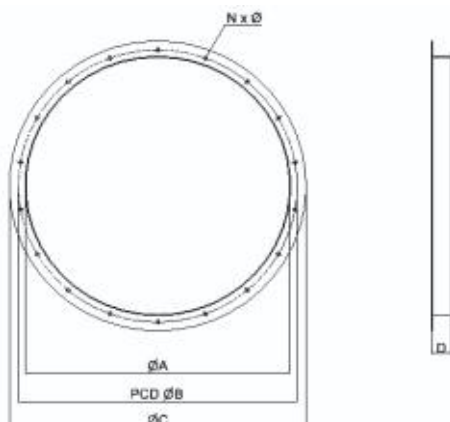

MODEL	$\varnothing A$	$\varnothing B$ (PCD)	$\varnothing C$	D	N x \varnothing
315	315	355	395	40	8 X 10
400	400	440	480	40	12 X 10
500	500	540	580	40	12 X 10
560	560	605	660	40	12 X 10
630	630	675	730	40	12 X 10
710	710	755	810	40	18 X 12
800	800	845	900	40	18 X 12
900	900	945	1000	60	18 X 12
1000	1000	1045	1100	60	24 X 12
1120	1120	1185	1250	60	24 X 12
1250	1250	1315	1380	60	24 X 12
1400	1400	1465	1530	60	32 X 14
1600	1600	1663	1730	60	32 X 14

Axial Fan Accessories

Vanes

For Vane Axial fan requirements, we supply guide Vanes along with Axial Fans. The Vanes are made of mild steel sheet duly powder coated. Powder coating thickness is 60 µm"

Sound Attenuators

We offer Circular Dissipative Silencers of different length, both at the inlet and exit of the Axial Fans, to reduce the airborne noise. The end caps have matching holes to exactly match the flange of the Fan.

Bird Screen

We also offer matching Bird screen along with the Axial Fans. The mesh wire is made of mild steel, with necessary crossing support.

Gravity Louver

Gravity louver can be offered at Axial Fan outlet with a matching flange. The flange & louvers are made of Steel Sheets.

Performance Curve FEG 56

ADTA 315-110-05
ADTA-F 315-110-05

50Hz 2880rpm

Outlet Area: 0.079 m²

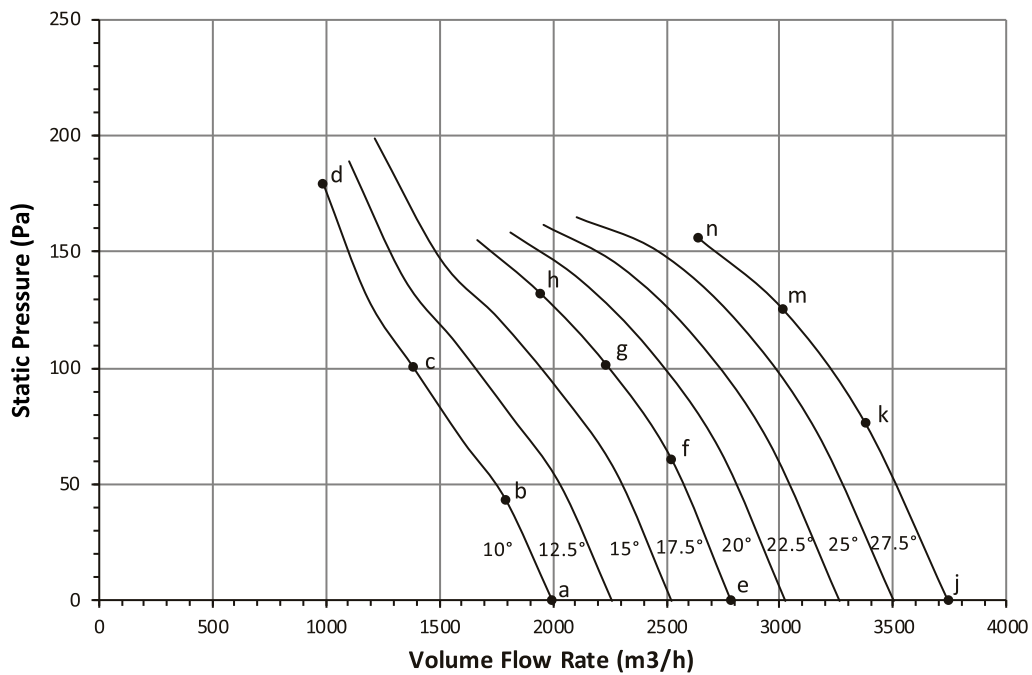
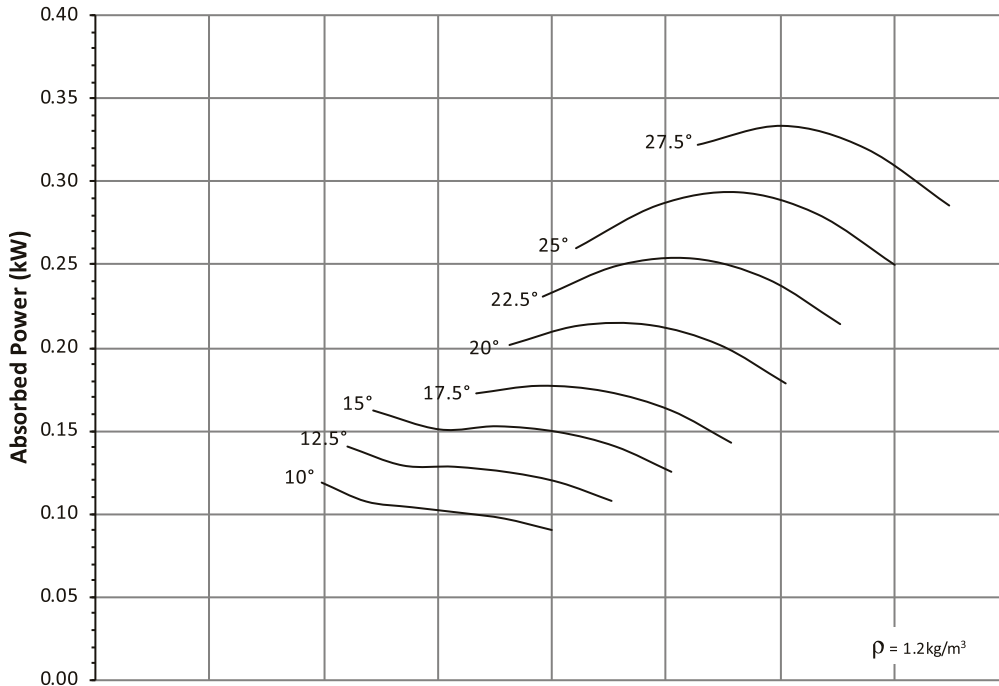

Ref	Full Octave Band Center Frequency							L _W A	
	63	125	250	500	1K	2K	4K		8K
a	98	82	77	76	77	75	72	69	82
b	98	82	76	77	78	76	72	68	83
c	98	82	83	88	84	79	72	67	89
d	99	87	88	80	78	73	70	66	84
e	92	82	79	73	77	75	73	69	82
f	90	83	77	73	78	73	73	70	81
g	89	83	80	81	81	78	74	71	85
h	89	85	86	88	86	81	75	70	90
j	95	81	78	75	79	73	73	70	82
k	96	86	78	74	79	73	73	70	83
m	96	86	80	76	80	75	73	72	84
n	96	86	84	80	81	76	73	72	85



Performance certified for Installation type D: Ducted Inlet- Ducted Outlet. Performance ratings do not include the effects of appurtenances (accessories). Power rating kW is fan input power. The Sound Power Level ratings shown are in decibels, referred to 10⁻¹² watts, calculated per AMCA International Standard 301. Values shown are for inlet L_w and L_wA sound power levels for Installation type D: Ducted Inlet-Ducted Outlet. Ratings include the effects of duct end correction. The A-weighted sound ratings shown have been calculated per AMCA International Standard 301.

Performance Curve
FEG 67

ADTA 400-160-10
ADTA-F 400-160-10

50Hz 2880 rpm

Outlet Area: 0.129 m²

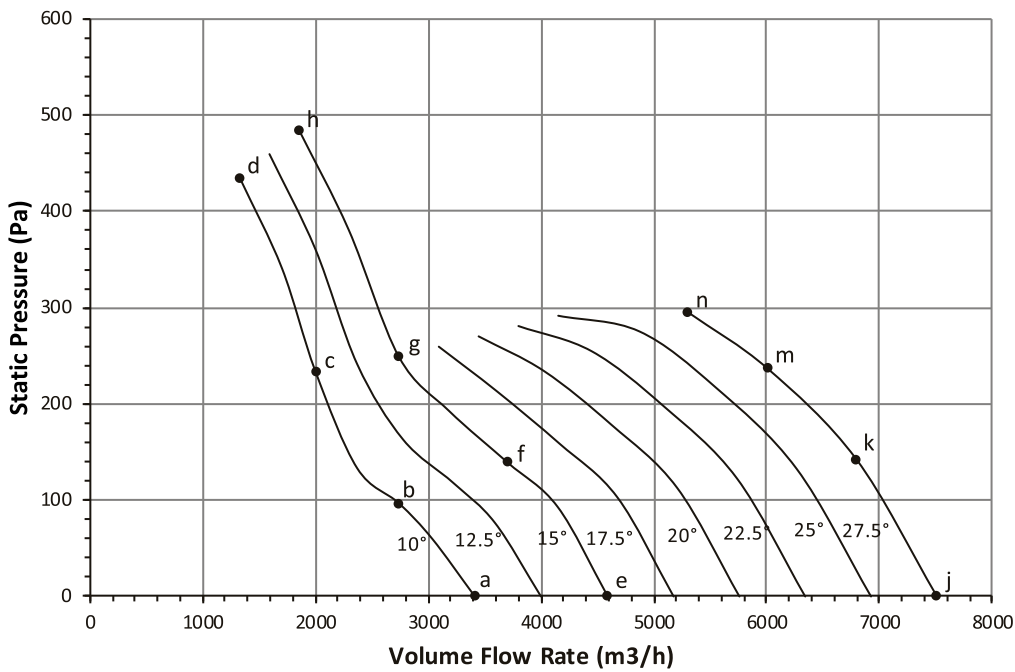
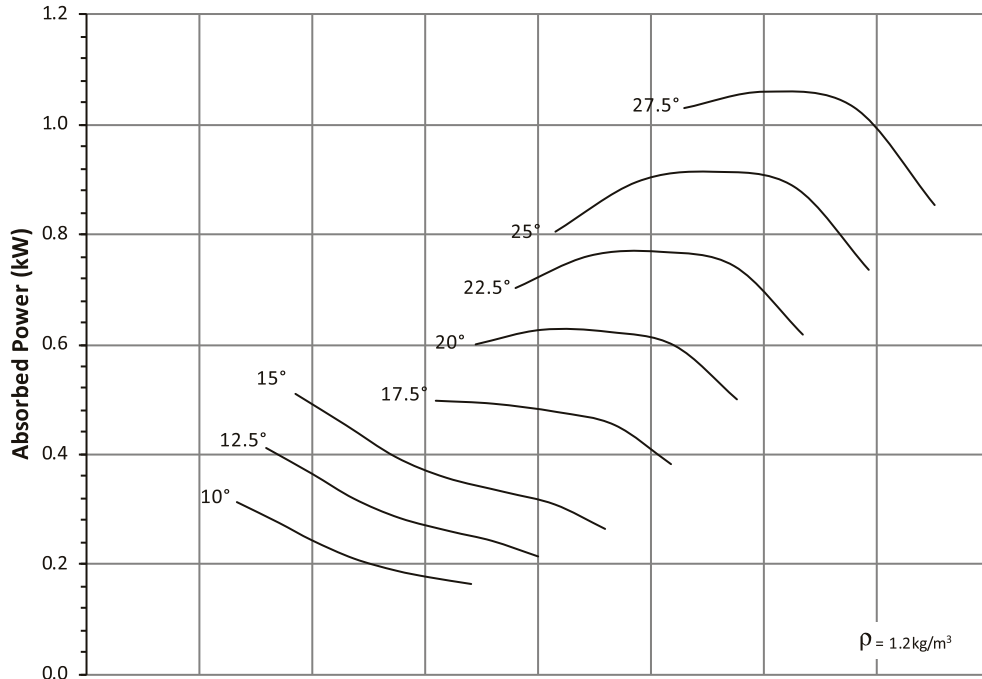

Ref	Full Octave Band Center Frequency							L _W A dB(A)	
	63	125	250	500	1K	2K	4K		8K
a	93	93	91	94	88	86	82	77	95
b	95	94	93	99	91	88	81	75	98
c	96	96	95	94	86	83	79	73	94
d	97	97	93	93	85	83	79	73	93
e	93	93	91	96	86	84	82	77	95
f	94	94	95	99	91	88	83	76	98
g	98	98	101	100	89	86	80	73	99
h	96	96	93	91	85	82	78	72	92
j	95	95	88	90	86	86	85	80	93
k	95	95	88	90	86	85	84	80	93
m	95	95	94	93	88	87	84	80	95
n	97	97	103	97	92	90	86	79	99



Performance certified is for Installation type D: Ducted Inlet- Ducted Outlet. Performance ratings do not include the effects of appurtenances (accessories) Power rating kW is fan input power. The Sound Power Level ratings shown are in decibels, referred to 10⁻¹² watts, calculated per AMCA International Standard 301. Values shown are for inlet L_W and L_WA sound power levels for Installation type D: Ducted Inlet-Ducted Outlet. Ratings include the effects of duct end correction. The A-weighted sound ratings shown have been calculated per AMCA International Standard 301.

Performance Curve FEG 85

ADTA 500-160-10
ADTA-F 500-160-10

50Hz 2880 rpm

Outlet Area: 0.200 m²

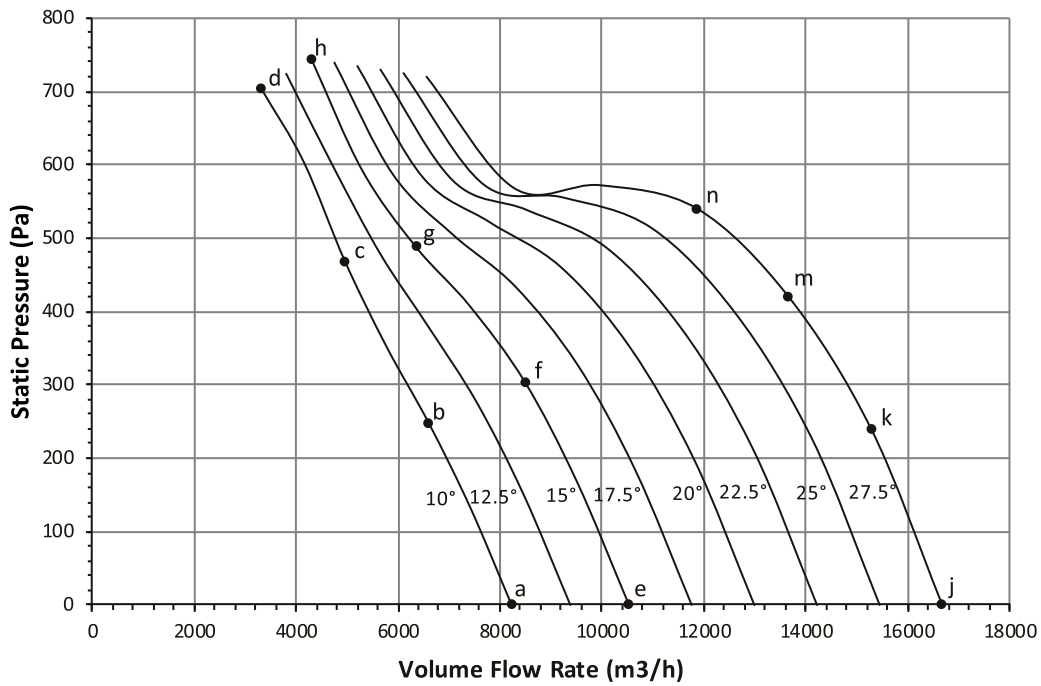
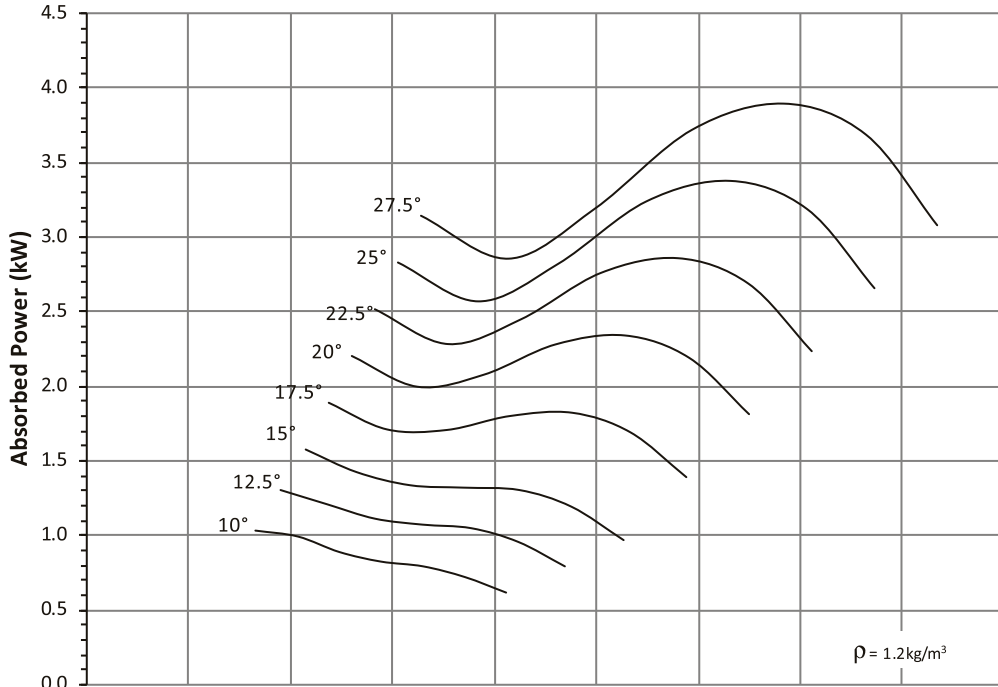

Ref	Full Octave Band Center Frequency								L _{WA} dB(A)
	63	125	250	500	1K	2K	4K	8K	
a	99	99	100	100	95	94	91	87	101
b	100	100	100	100	98	96	90	84	103
c	105	105	107	107	96	92	88	81	106
d	102	102	101	101	91	88	86	81	100
e	98	98	100	100	94	92	91	87	101
f	98	98	99	99	97	96	92	86	103
g	107	107	120	107	98	93	89	82	112
h	104	104	104	99	93	89	86	81	101
j	96	96	101	100	97	92	90	88	102
k	97	97	96	96	99	92	90	88	101
m	111	111	108	104	99	94	90	84	106
n	108	108	105	102	99	94	90	85	104



Performance certified for Installation type D: Ducted Inlet- Ducted Outlet. Performance ratings do not include the effects of appurtenances (accessories). Power rating kW is fan input power. The Sound Power Level ratings shown are in decibels, referred to 10⁻¹² watts, calculated per AMCA International Standard 301. Values shown are for inlet L_w and L_{WA} sound power levels for Installation type D: Ducted Inlet-Ducted Outlet. Ratings include the effects of duct end correction. The A-weighted sound ratings shown have been calculated per AMCA International Standard 301.

Performance Curve
FEG 67

ADTA 560-160-10
ADTA-F 560-160-10

50Hz 2880 rpm

Outlet Area: 0.248 m²

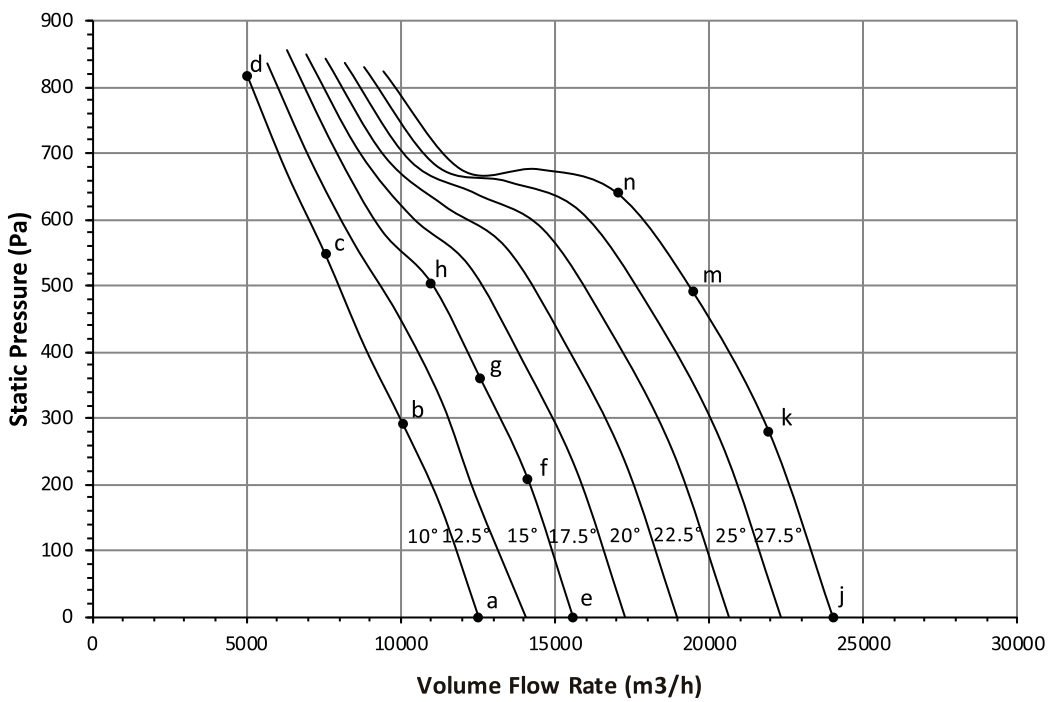
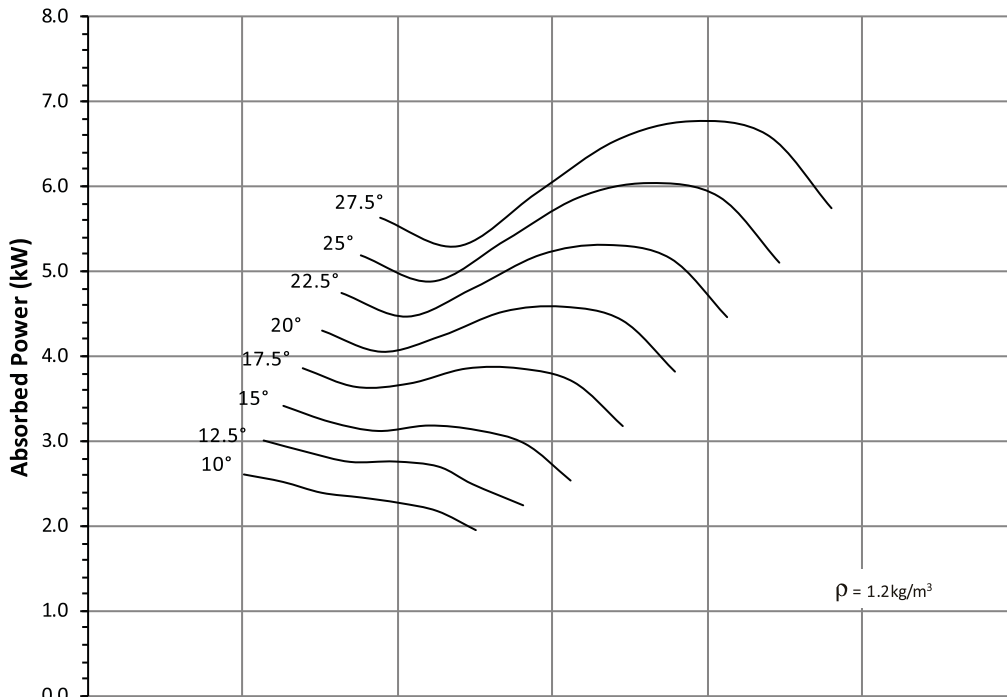

Ref	Full Octave Band Center Frequency								L _{WA} dB(A)
	63	125	250	500	1K	2K	4K	8K	
a	100	100	95	95	96	96	95	91	102
b	101	101	98	94	100	100	95	89	104
c	108	108	106	103	100	96	93	87	106
d	107	107	106	97	93	91	90	85	102
e	100	100	94	94	95	95	94	91	101
f	98	98	91	91	94	94	94	91	100
g	101	101	98	95	100	100	97	91	105
h	103	103	101	99	102	100	95	89	106
j	101	101	98	97	98	95	93	92	103
k	100	100	97	97	99	95	92	91	103
m	105	105	102	102	100	97	95	92	105
n	106	106	106	103	102	99	96	92	107



Performance certified is for Installation type D: Ducted Inlet- Ducted Outlet. Performance ratings do not include the effects of appurtenances (accessories) Power rating kW is fan input power. The Sound Power Level ratings shown are in decibels, referred to 10⁻¹² watts, calculated per AMCA International Standard 301. Values shown are for inlet L_{WA} and L_{WA} sound power levels for Installation type D: Ducted Inlet-Ducted Outlet. Ratings include the effects of duct end correction. The A-weighted sound ratings shown have been calculated per AMCA International Standard 301.

Performance Curve FEG 90

ADTA 630-160-05
ADTA-F 630-160-05

50Hz 2880rpm

Outlet Area: 0.312 m²

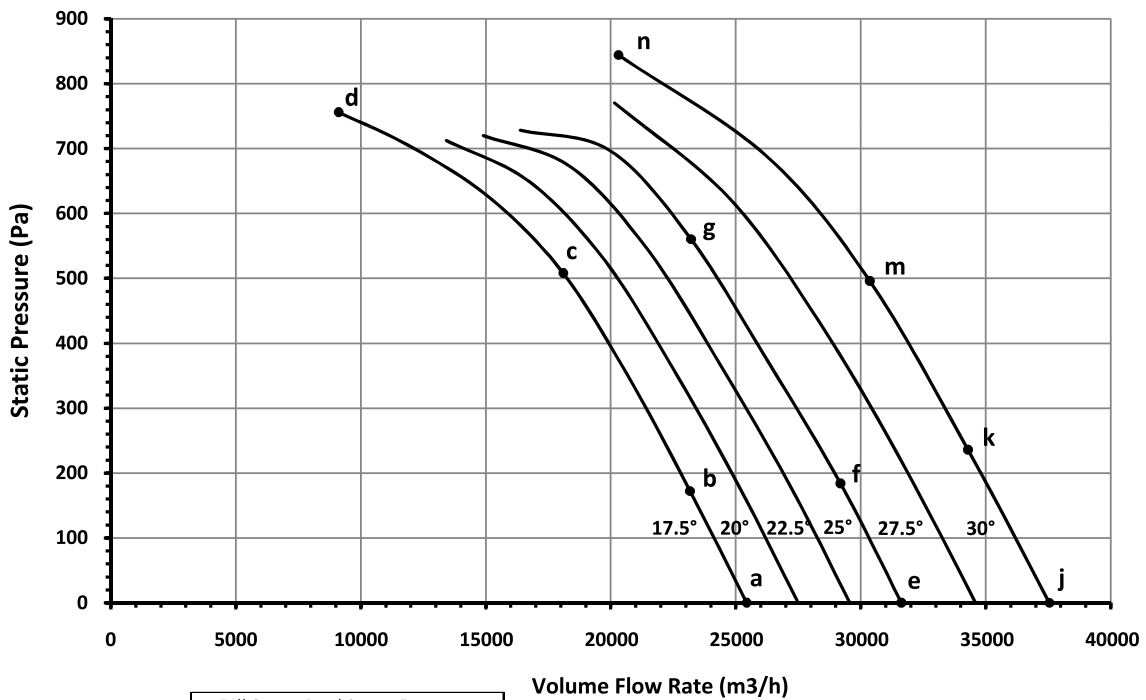
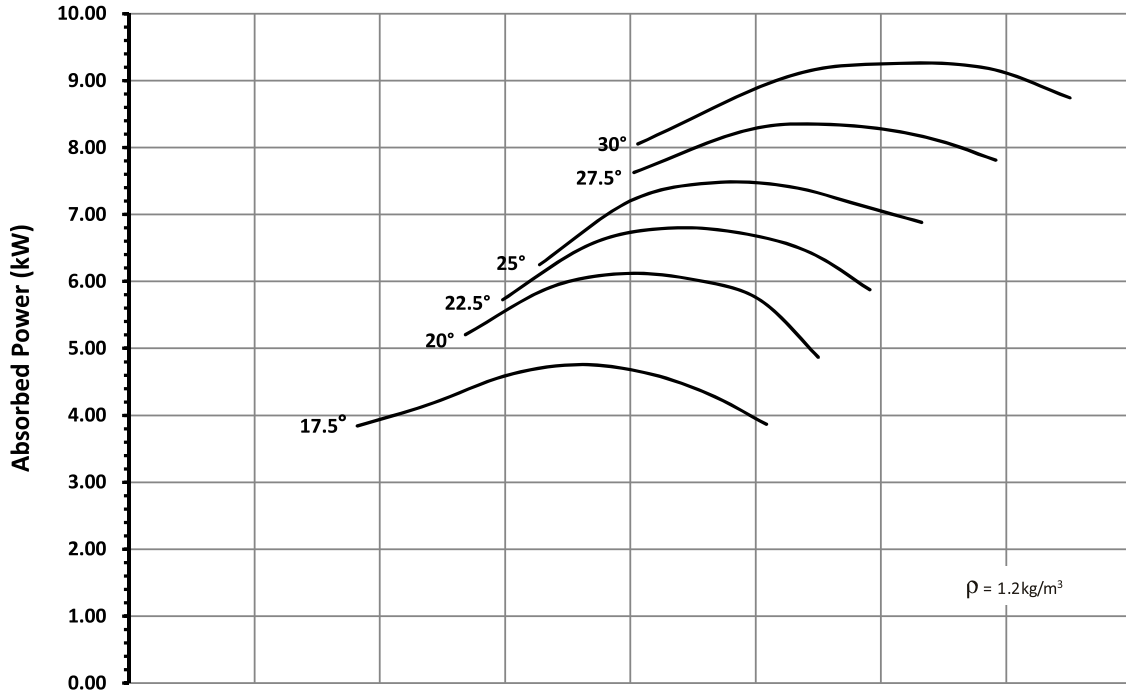

Ref	Full Octave Band Center Frequency								L _w A dB(A)
	63	125	250	500	1K	2K	4K	8K	
a	100	100	93	90	93	92	90	90	99
b	97	97	93	90	93	91	90	90	98
c	98	98	93	93	96	95	93	91	101
d	107	107	98	106	111	103	98	92	113
e	101	101	96	93	96	93	91	91	101
f	99	99	95	93	96	93	91	90	101
g	102	102	95	94	97	93	92	91	101
j	103	103	99	96	97	95	93	91	102
k	102	102	97	95	96	94	93	91	102
m	104	104	98	93	96	95	94	92	102
n	118	118	109	99	97	95	92	89	107



Performance certified is for Installation type D: Ducted Inlet- Ducted Outlet. Performance ratings do not include the effects of appurtenances (accessories). Power rating kW is fan input power. The Sound Power Level ratings shown are in decibels, referred to 10⁻¹² watts, calculated per AMCA International Standard 301. Values shown are for inlet L_w and L_wA sound power levels for Installation type D: Ducted Inlet-Ducted Outlet. Ratings include the effects of duct end correction. The A-weighted sound ratings shown have been calculated per AMCA International Standard 301.

Performance Curve
FEG 60

ADTA 630-230-12
ADTA-F 630-230-12

50Hz 2880 rpm

Outlet Area: 0.312 m²

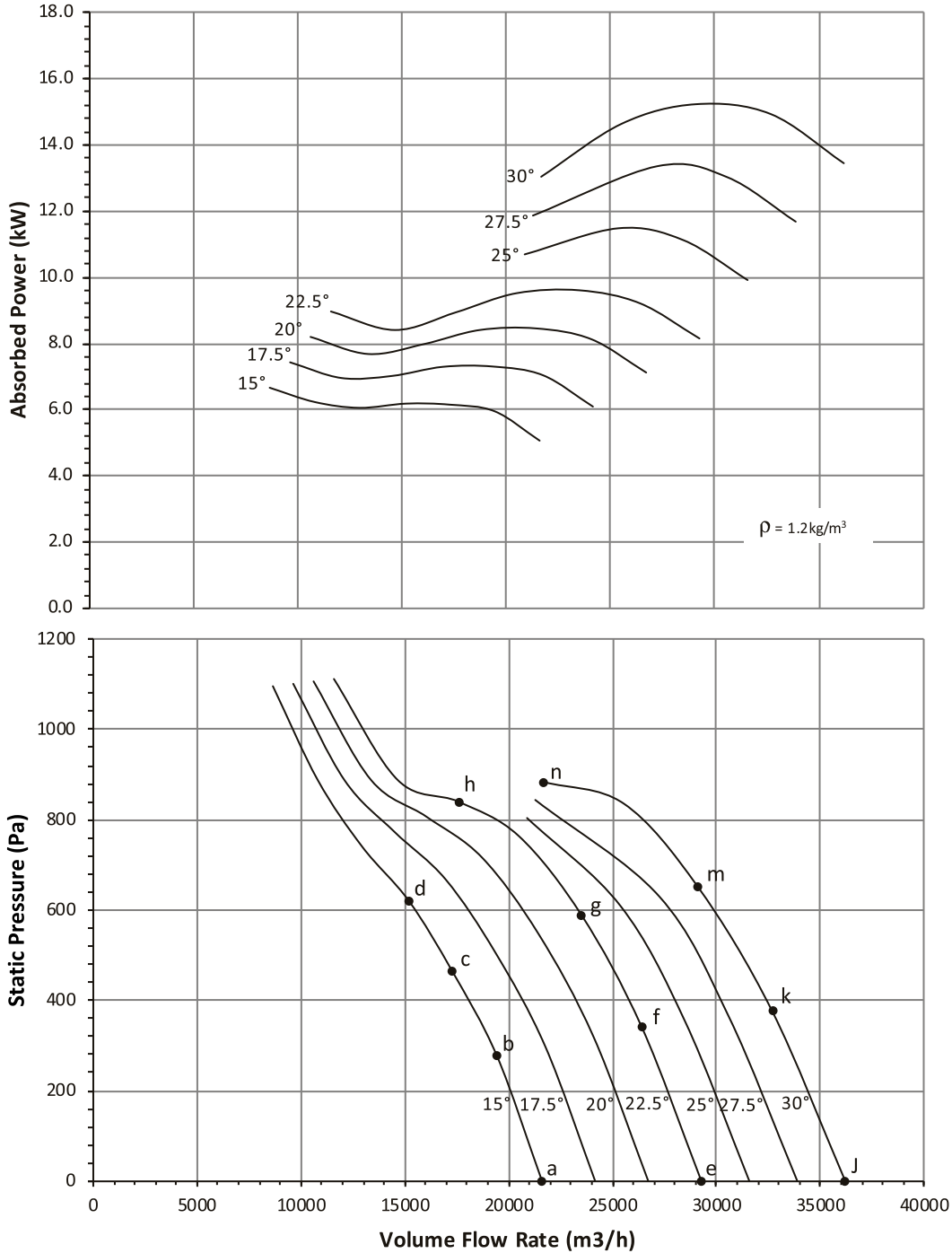

Ref	Full Octave Band Center Frequency								L _{WA} dB(A)
	63	125	250	500	1K	2K	4K	8K	
a	102	102	95	95	97	97	97	96	104
b	103	102	95	95	96	98	97	95	104
c	104	104	101	102	102	104	101	95	109
d	105	105	106	106	105	104	100	94	111
e	106	105	96	96	97	96	96	96	104
f	106	105	97	97	97	96	95	95	103
g	108	108	103	103	100	100	99	95	107
h	109	109	112	111	107	105	99	94	113
j	106	106	98	98	100	98	96	96	105
k	106	106	99	99	100	98	96	95	105
m	107	107	102	102	103	100	98	96	107
n	112	112	114	110	108	105	101	95	113



Performance certified is for Installation type D: Ducted Inlet- Ducted Outlet. Performance ratings do not include the effects of appurtenances (accessories). Power rating kW is fan input power. The Sound Power Level ratings shown are in decibels, referred to 10⁻¹² watts, calculated per AMCA International Standard 301. Values shown are for inlet L_{WA} and L_{WA} sound power levels for Installation type D: Ducted Inlet-Ducted Outlet. Ratings include the effects of duct end correction. The A-weighted sound ratings shown have been calculated per AMCA International Standard 301.

Performance Curve FEG 75

ADTA 710-230-06
ADTA-F 710-230-06

50Hz 2880rpm

Outlet Area: 0.396 m²

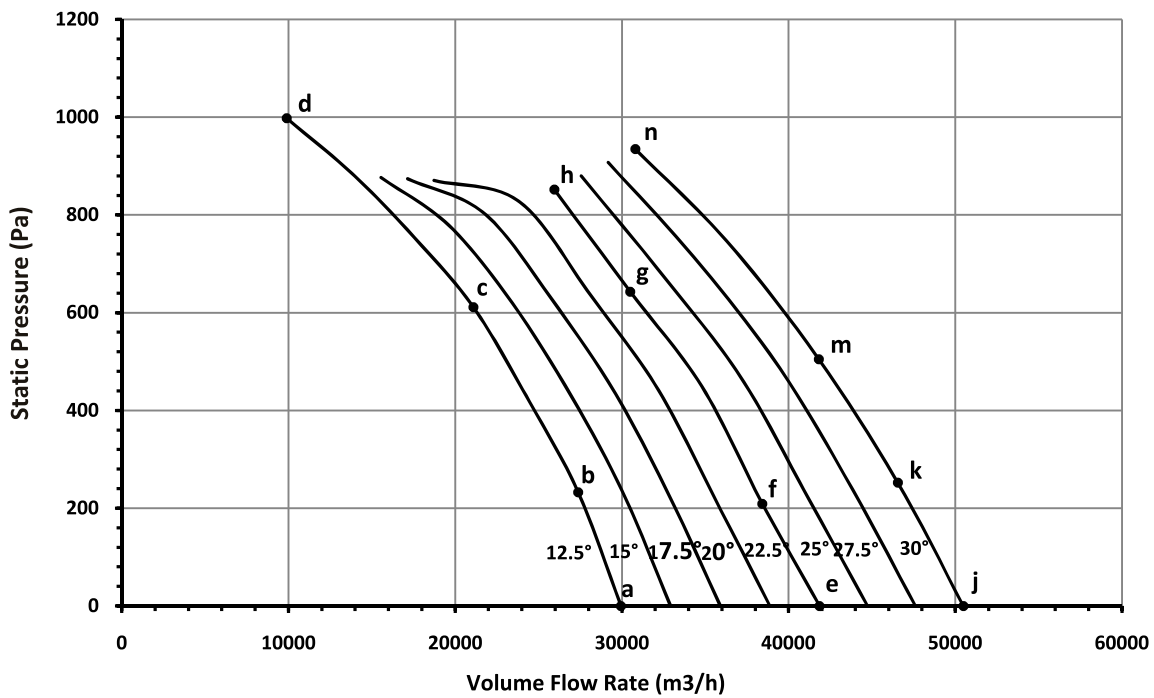
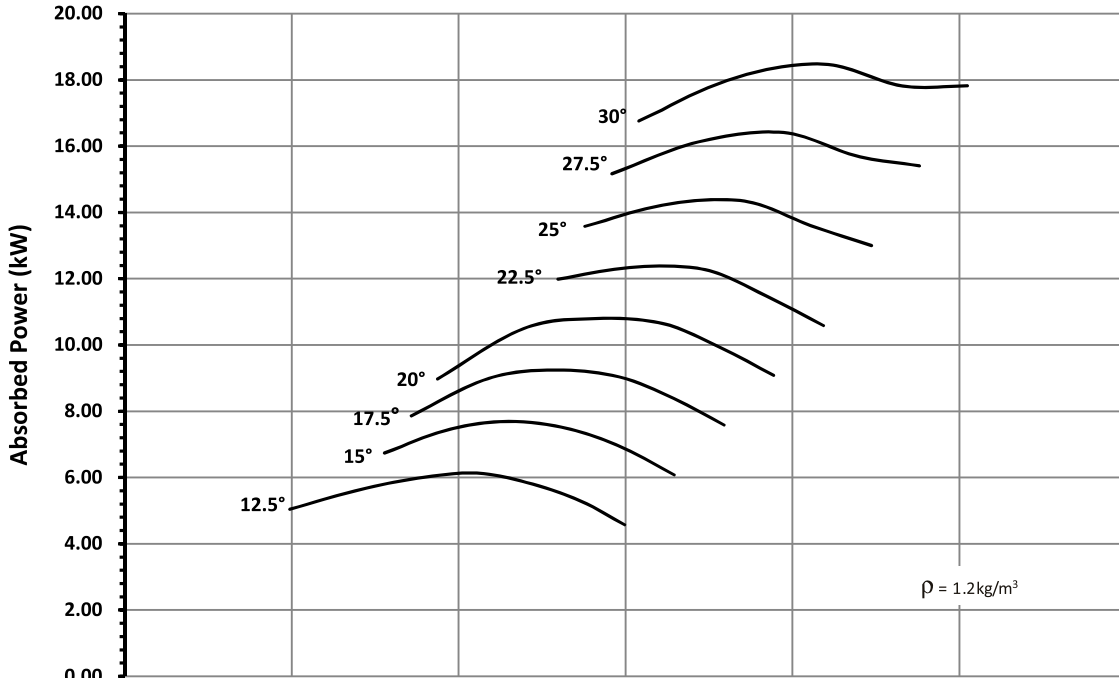

Ref	Full Octave Band Center Frequency								L _{WA} dB(A)
	63	125	250	500	1K	2K	4K	8K	
a	94	94	93	92	95	95	93	94	101
b	91	91	92	91	94	94	92	92	100
c	98	98	93	95	102	104	101	95	109
d	101	101	97	103	112	106	101	95	114
e	100	100	100	103	99	98	95	94	106
f	100	100	101	96	98	97	96	94	104
g	99	99	100	96	98	98	97	95	105
h	98	99	100	96	99	100	99	95	106
j	104	104	102	100	101	101	99	96	107
k	103	103	101	100	100	100	99	96	106
m	104	104	102	99	99	100	99	96	106
n	103	103	102	101	101	102	100	96	107



Performance certified for Installation type D: Ducted Inlet- Ducted Outlet. Performance ratings do not include the effects of appurtenances (accessories). Power rating kW is fan input power. The Sound Power Level ratings shown are in decibels, referred to 10⁻¹² watts, calculated per AMCA International Standard 301. Values shown are for inlet L_w and L_{wA} sound power levels for Installation type D: Ducted Inlet-Ducted Outlet. Ratings include the effects of duct end correction. The A-weighted sound ratings shown have been calculated per AMCA International Standard 301.

Performance Curve FEG 71

ADTA 710-250-12
ADTA-F 710-250-12

50Hz 2880rpm

Outlet Area: 0.396 m²

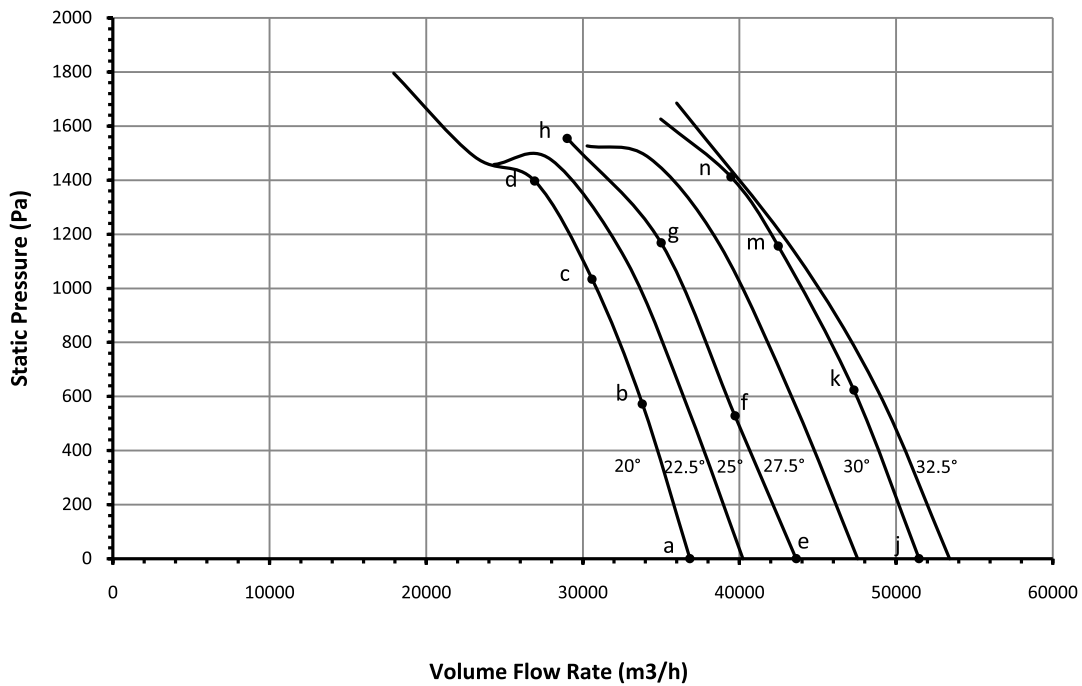
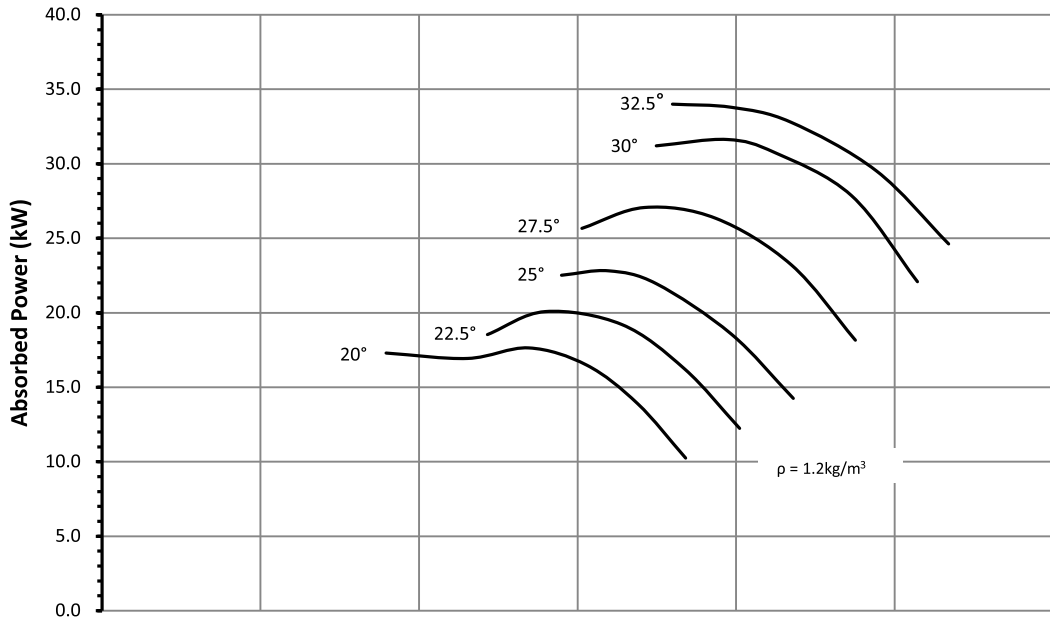

Ref	Full Octave Band Center Frequency								L _W iA dB(A)
	63	125	250	500	1K	2K	4K	8K	
a	107	106	95	101	101	99	98	97	106
b	107	106	95	100	99	98	97	96	105
c	102	101	95	100	103	100	99	95	107
d	103	103	100	104	111	106	102	96	113
e	104	104	97	101	101	100	99	98	107
f	105	105	97	101	100	100	98	96	106
g	105	105	97	101	102	100	98	94	107
h	108	108	108	110	111	106	102	96	114
j	106	106	99	102	103	102	99	98	108
k	107	107	98	103	102	100	98	95	107
m	107	107	97	104	101	100	98	93	107
n	108	108	103	107	104	102	99	95	110



Performance certified is for Installation type D: Ducted Inlet- Ducted Outlet. Performance ratings do not include the effects of appurtenances (accessories)
Power rating kW is fan input power.
The Sound Power Level ratings shown are in decibels, referred to 10-12 watts, calculated per AMCA International Standard 301. Values shown are for inlet L_Wi and L_WiA sound power levels for Installation type D: Ducted Inlet-Ducted Outlet. Ratings include the effects of duct end correction.
The A-weighted sound ratings shown have been calculated per AMCA International Standard 301.

4 Pole - 1440 rpm

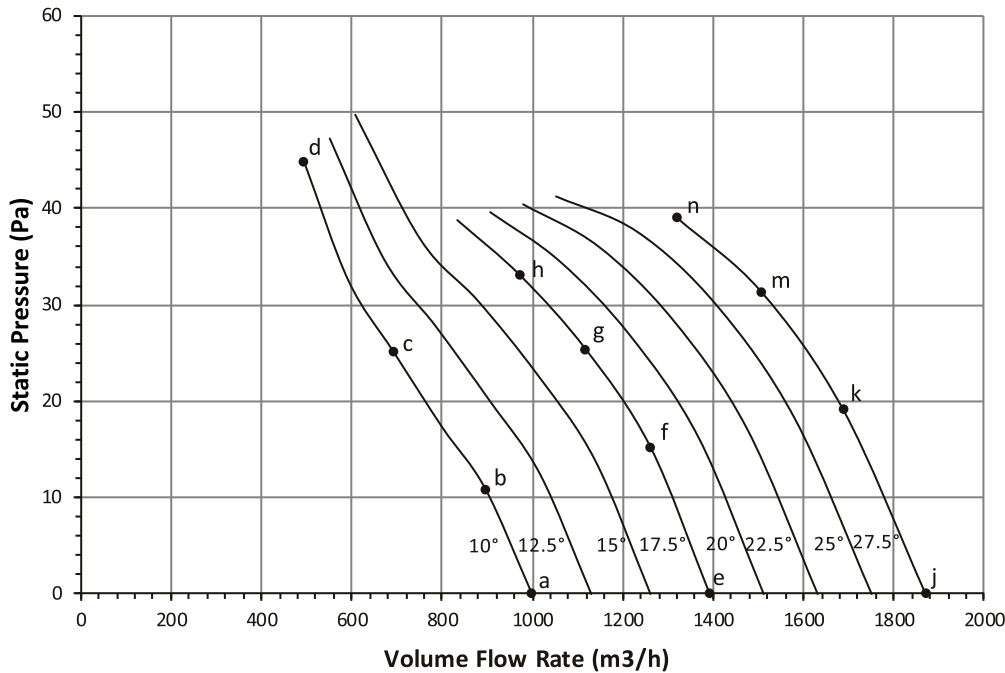
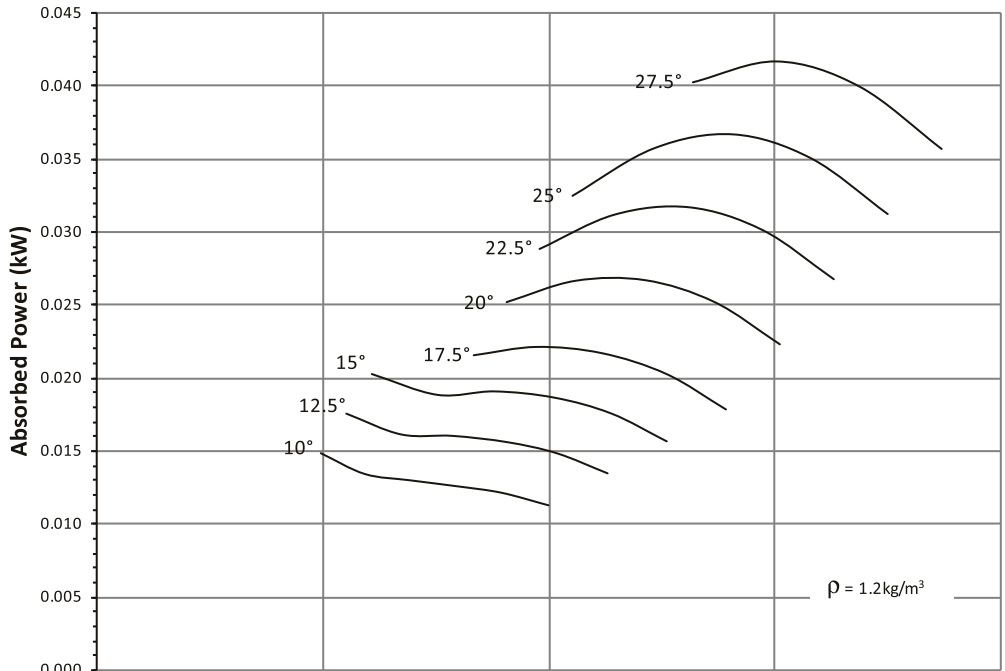

Ref	Full Octave Band Center Frequency								L _{WA} dB(A)
	63	125	250	500	1K	2K	4K	8K	
a	67	62	61	62	60	57	54	51	65
b	67	61	61	63	61	57	53	49	66
c	67	68	73	69	64	57	52	47	70
d	73	73	65	63	58	55	51	47	65
e	66	65	58	61	60	58	54	50	65
f	67	62	58	62	58	58	55	52	64
g	68	65	66	66	63	59	56	53	68
h	70	71	73	71	66	60	55	49	71
j	66	63	60	64	58	58	55	52	65
k	71	63	59	64	58	58	55	52	65
m	71	65	61	65	60	58	57	56	67
n	71	69	65	66	61	58	57	56	68



Performance certified is for Installation type D: Ducted Inlet- Ducted Outlet. Performance ratings do not include the effects of appurtenances (accessories) Power rating kW is fan input power.
The Sound Power Level ratings shown are in decibels, referred to 10⁻¹² watts, calculated per AMCA International Standard 301. Values shown are for inlet L_{WA} and L_{WA} sound power levels for Installation type D: Ducted Inlet-Ducted Outlet. Ratings include the effects of duct end correction.
The A-weighted sound ratings shown have been calculated per AMCA International Standard 301.

Performance Curve
FEG 67

ADTA 400-160-10
ADTA-F 400-160-10

50Hz 1440 rpm

Outlet Area: 0.129 m²

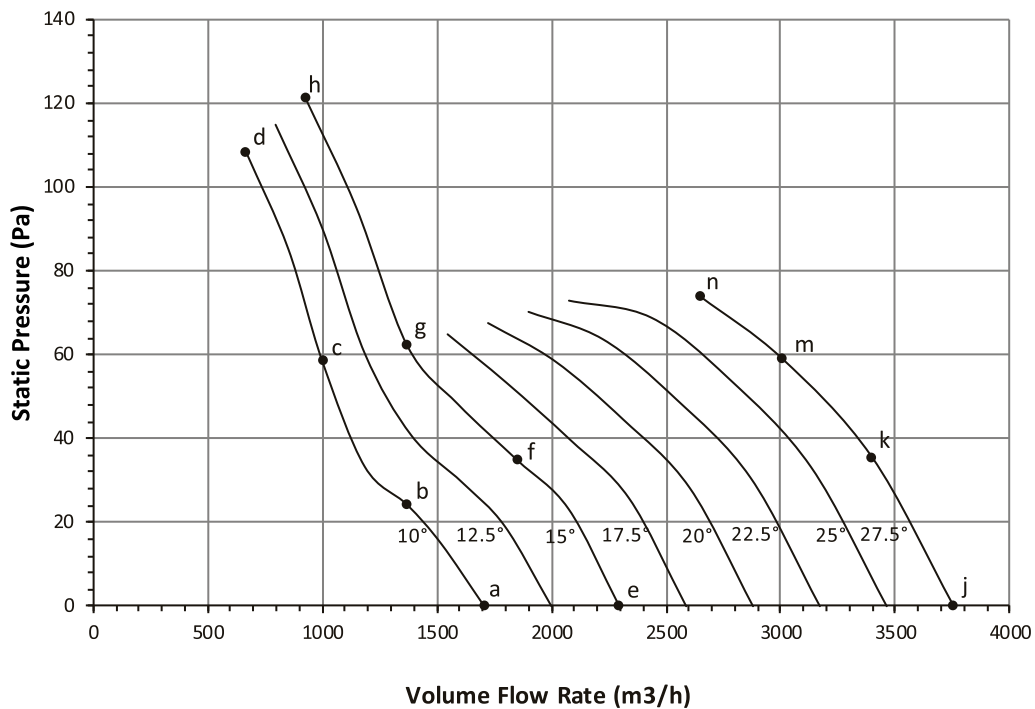
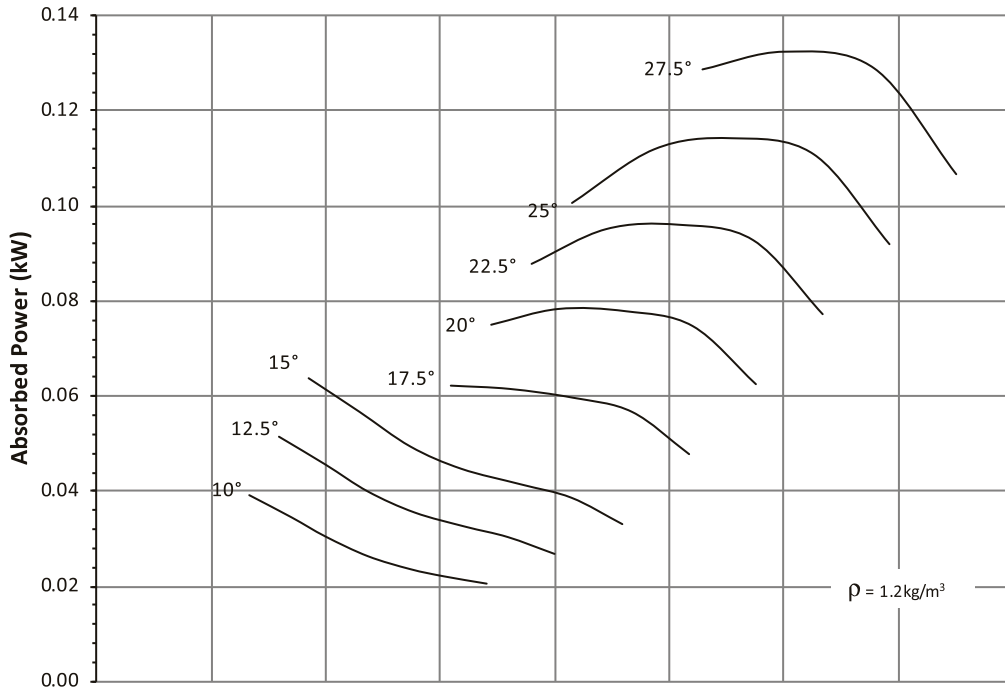

4 Pole - 1440 rpm

Ref	Full Octave Band Center Frequency								L _w A dB(A)
	63	125	250	500	1K	2K	4K	8K	
a	78	76	79	73	71	67	62	55	77
b	79	78	84	76	73	66	60	53	79
c	81	80	79	71	68	64	58	50	75
d	82	78	78	70	68	64	58	50	74
e	78	76	81	71	69	67	62	56	77
f	79	80	84	76	73	68	61	53	79
g	83	86	85	74	71	65	58	50	79
h	81	78	75	70	66	63	57	52	73
j	80	73	75	71	71	70	65	60	76
k	80	73	75	71	70	69	65	59	75
m	80	79	78	73	72	69	65	59	77
n	82	88	82	77	75	71	64	57	80



Performance certified for Installation type D: Ducted Inlet- Ducted Outlet. Performance ratings do not include the effects of appurtenances (accessories) Power rating kW is fan input power. The Sound Power Level ratings shown are in decibels, referred to 10⁻¹² watts, calculated per AMCA International Standard 301. Values shown are for inlet L_w and L_wA sound power levels for Installation type D: Ducted Inlet-Ducted Outlet. Ratings include the effects of duct end correction. The A-weighted sound ratings shown have been calculated per AMCA International Standard 301.

4 Pole - 1440 rpm

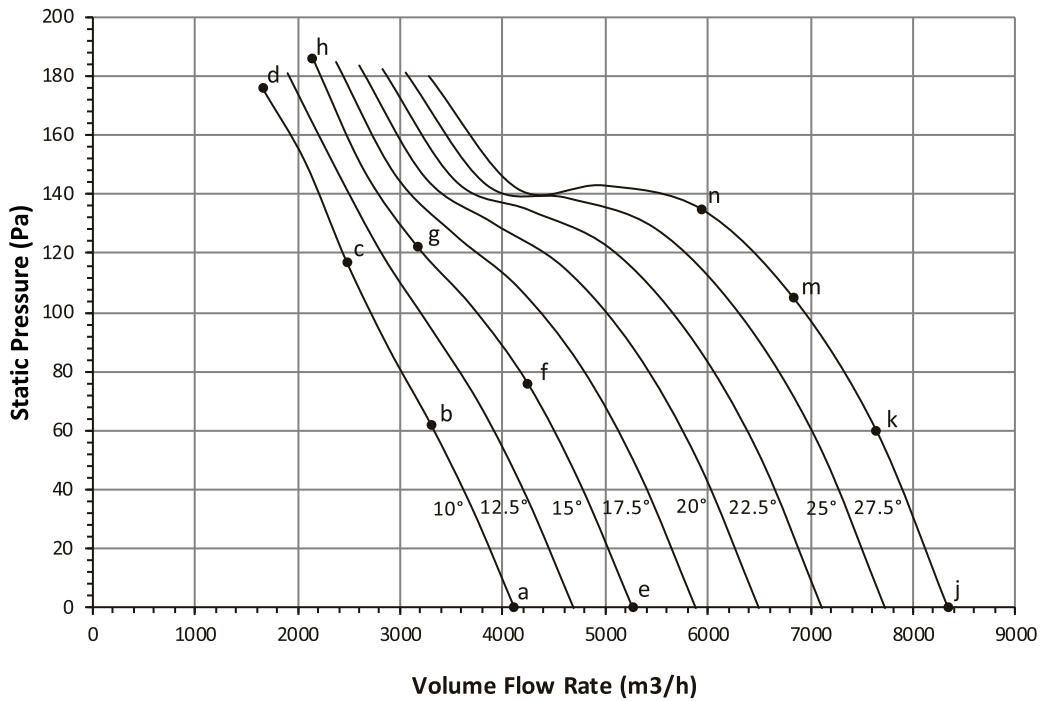
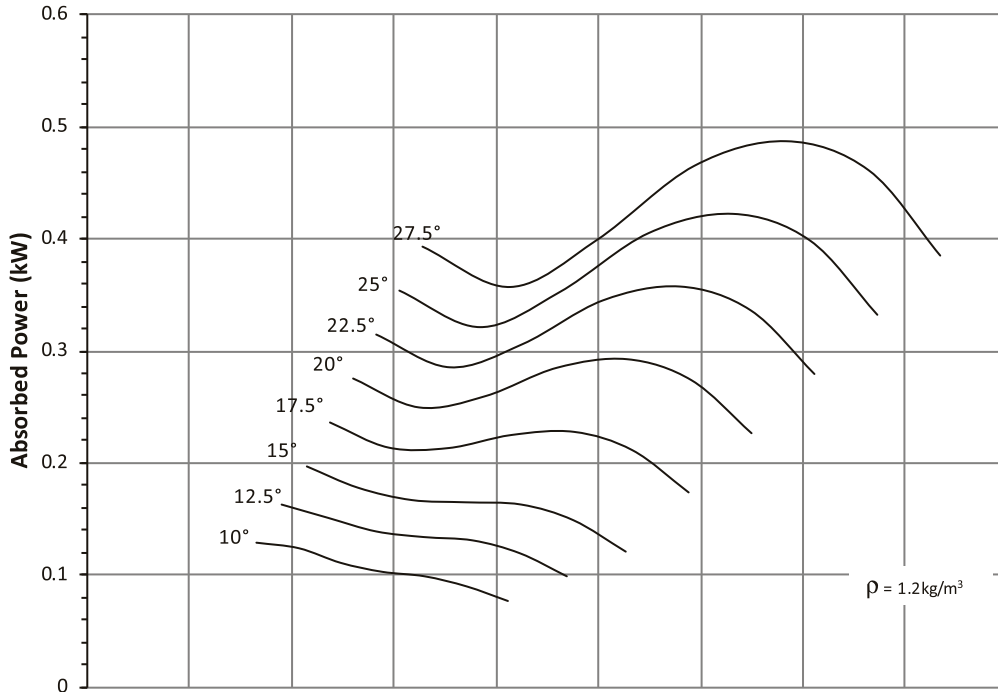

Ref	Full Octave Band Center Frequency							L _W A dB(A)	
	63	125	250	500	1K	2K	4K		8K
a	84	80	85	80	79	76	72	64	84
b	85	81	85	83	81	75	69	61	85
c	90	93	92	81	77	73	66	58	86
d	87	90	86	76	73	71	66	57	81
e	83	76	85	79	77	76	72	65	83
f	83	80	84	82	81	77	71	63	85
g	92	105	92	83	78	74	67	59	91
h	89	89	83	77	73	71	66	58	80
j	81	74	86	82	77	75	73	68	84
k	82	76	81	84	77	75	73	67	84
m	86	83	84	85	80	76	73	66	86
n	93	90	87	84	79	75	70	64	86



Performance certified is for Installation type D: Ducted Inlet- Ducted Outlet. Performance ratings do not include the effects of appurtenances (accessories) Power rating kW is fan input power. The Sound Power Level ratings shown are in decibels, referred to 10⁻¹² watts, calculated per AMCA International Standard 301. Values shown are for inlet L_W and L_WA sound power levels for Installation type D: Ducted Inlet-Ducted Outlet. Ratings include the effects of duct end correction. The A-weighted sound ratings shown have been calculated per AMCA International Standard 301.

Performance Curve FEG 67

ADTA 560-160-10
ADTA-F 560-160-10

50Hz 1440 rpm

Outlet Area: 0.248 m²

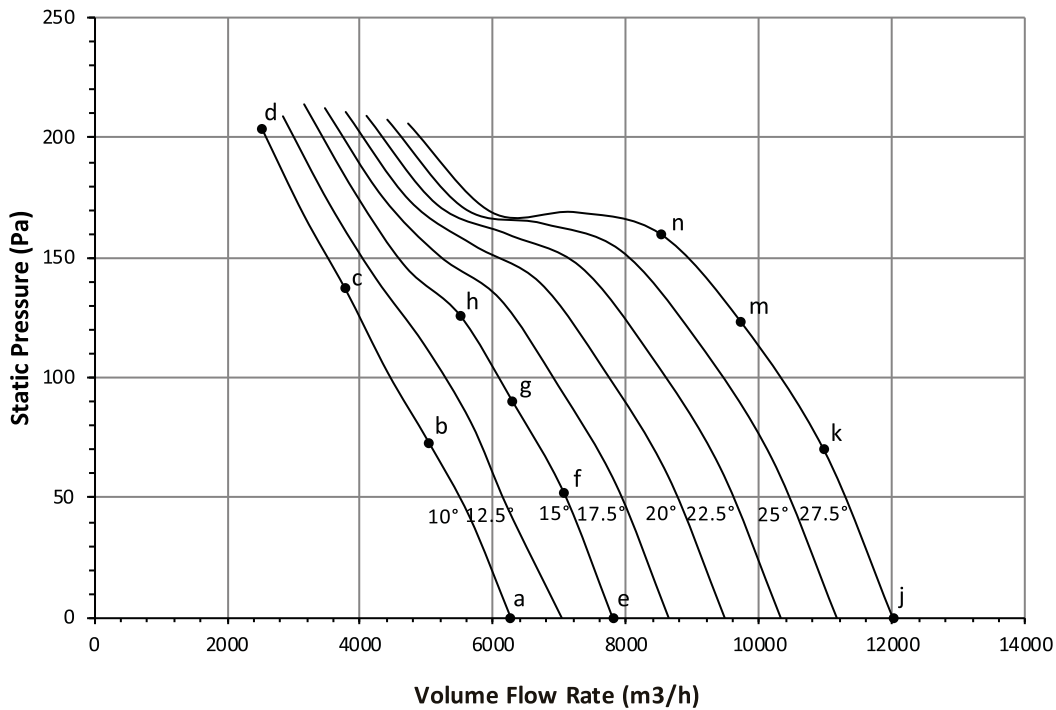
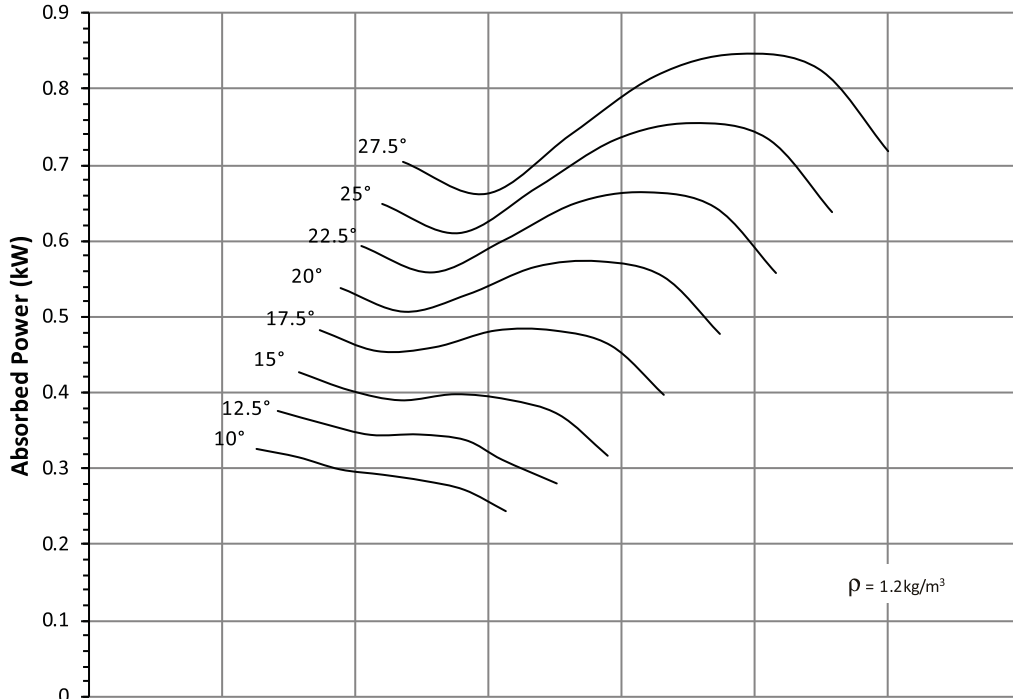

Ref	Full Octave Band Center Frequency							L _w /A dB(A)	
	63	125	250	500	1K	2K	4K		8K
a	85	77	80	81	81	80	76	69	86
b	86	83	79	85	85	80	74	67	88
c	93	91	89	86	82	78	72	63	88
d	92	91	82	78	76	75	70	62	83
e	85	75	79	80	80	79	76	70	85
f	83	74	76	79	79	79	76	70	84
g	86	83	80	85	85	82	76	69	88
h	88	86	84	87	85	80	74	66	89
j	86	76	83	83	80	78	77	71	86
k	85	79	82	84	80	77	76	72	86
m	90	87	87	85	82	80	77	71	88
n	92	92	89	88	85	82	77	70	90



Performance certified for Installation type D: Ducted Inlet- Ducted Outlet. Performance ratings do not include the effects of appurtenances (accessories)
Power rating kW is fan input power.
The Sound Power Level ratings shown are in decibels, referred to 10⁻¹² watts, calculated per AMCA International Standard 301. Values shown are for inlet L_w and L_w/A sound power levels for Installation type D: Ducted Inlet-Ducted Outlet. Ratings include the effects of duct end correction.
The A-weighted sound ratings shown have been calculated per AMCA International Standard 301.

4 Pole - 1440 rpm

4 Pole - 1440 rpm

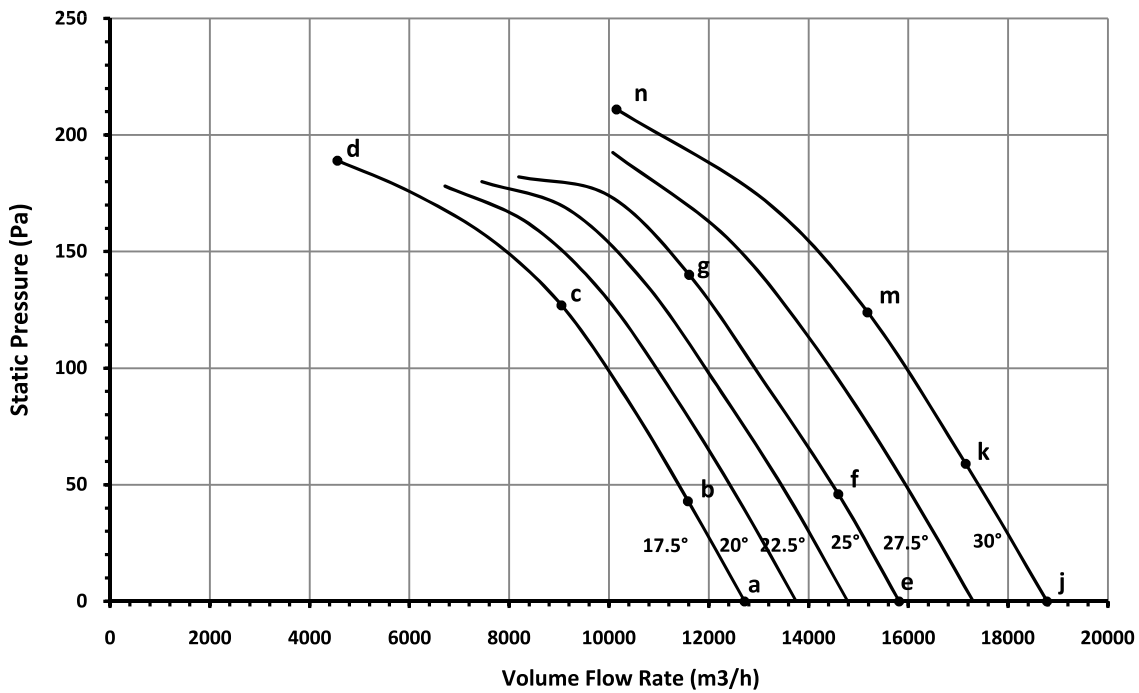
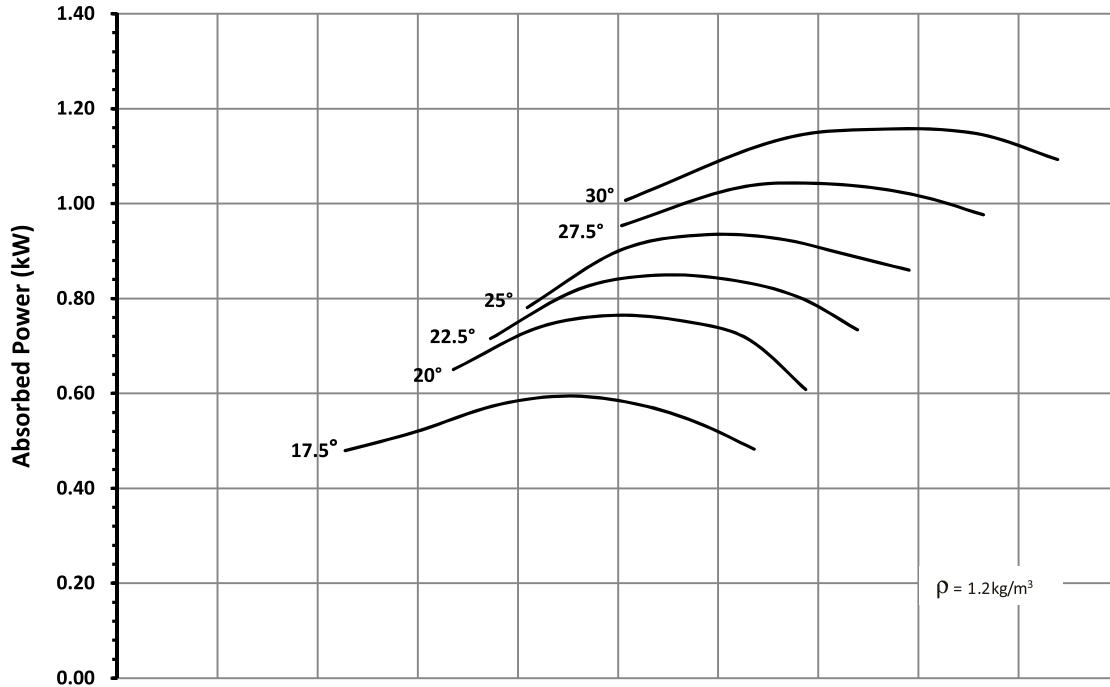

Ref	Full Octave Band Center Frequency								L _{WA} dB(A)
	63	125	250	500	1K	2K	4K	8K	
a	85	78	75	78	77	75	75	73	83
b	82	78	75	78	76	75	75	72	83
c	83	78	78	81	80	78	76	73	85
d	92	82	91	96	88	83	77	72	95
e	86	81	78	81	78	76	76	73	84
f	84	80	78	81	78	76	75	73	84
g	87	80	79	82	78	77	76	73	85
j	88	84	80	82	80	78	76	74	86
k	87	82	79	81	79	78	76	73	85
m	89	83	78	81	80	79	77	74	86
n	103	94	84	82	80	77	74	69	87



Performance certified is for Installation type D: Ducted Inlet- Ducted Outlet. Performance ratings do not include the effects of appurtenances (accessories). Power rating kW is fan input power. The Sound Power Level ratings shown are in decibels, referred to 10⁻¹² watts, calculated per AMCA International Standard 301. Values shown are for inlet L_{WA} and L_{WA} sound power levels for Installation type D: Ducted Inlet-Ducted Outlet. Ratings include the effects of duct end correction. The A-weighted sound ratings shown have been calculated per AMCA International Standard 301.

Performance Curve FEG 60

ADTA 630-230-12
ADTA-F 630-230-12

50Hz 1440 rpm

Outlet Area: 0.312 m²

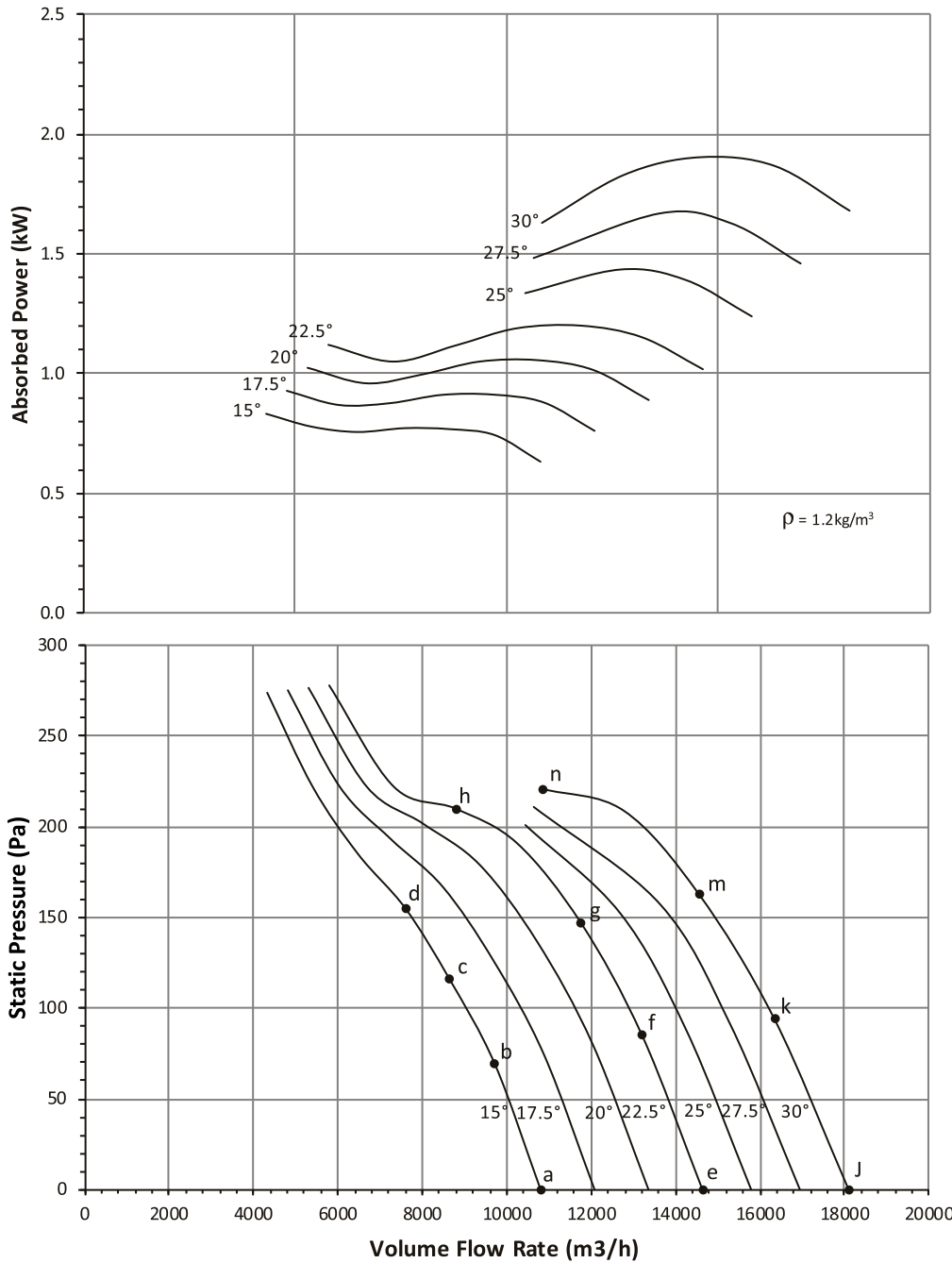

4 Pole - 1440 rpm

Ref	Full Octave Band Center Frequency								L _{WA} dB(A)
	63	125	250	500	1K	2K	4K	8K	
a	88	79	81	83	83	83	82	77	89
b	88	77	80	81	83	82	81	76	88
c	89	80	86	87	89	87	81	75	93
d	91	83	92	91	90	86	80	73	94
e	91	78	81	83	82	81	82	77	88
f	91	79	82	82	81	80	81	76	87
g	93	83	87	85	85	84	81	76	90
h	94	89	97	92	91	85	80	73	95
j	91	79	83	85	83	81	81	77	89
k	91	81	84	85	83	81	80	76	89
m	92	85	87	88	85	83	81	76	91
n	97	99	95	93	90	86	80	73	95



Performance certified for Installation type D: Ducted Inlet- Ducted Outlet. Performance ratings do not include the effects of appurtenances (accessories)
Power rating kW is fan input power.
The Sound Power Level ratings shown are in decibels, referred to 10⁻¹² watts, calculated per AMCA International Standard 301. Values shown are for inlet L_w and L_wA sound power levels for Installation type D: Ducted Inlet-Ducted Outlet. Ratings include the effects of duct end correction.
The A-weighted sound ratings shown have been calculated per AMCA International Standard 301.

4 Pole - 1440 rpm

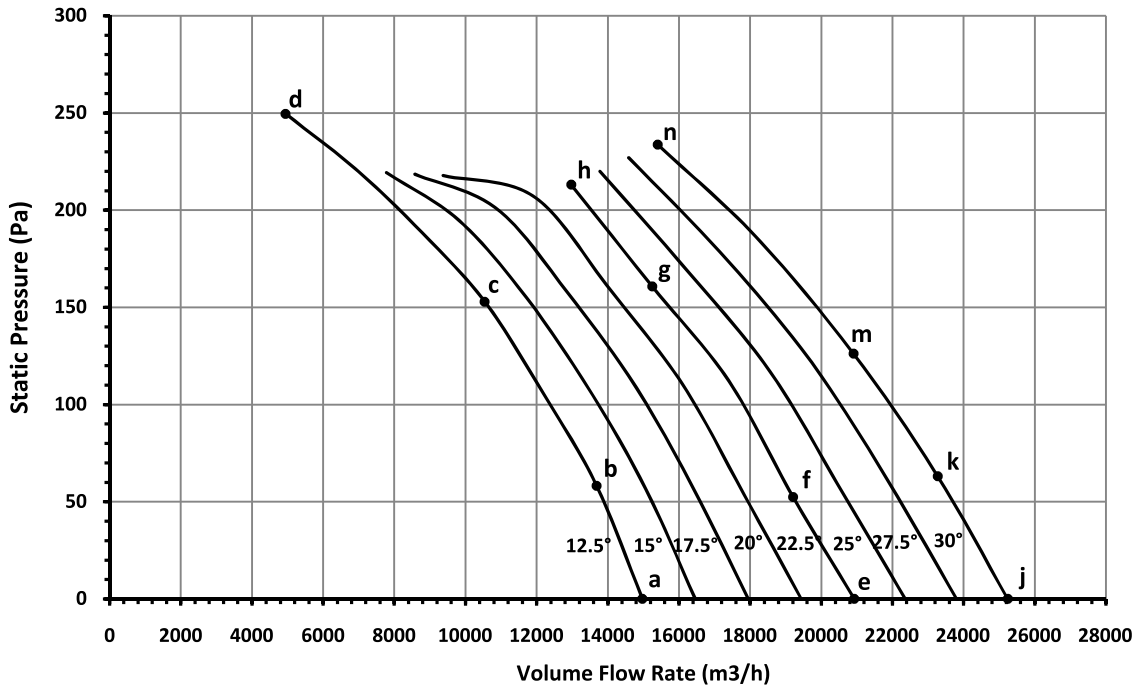
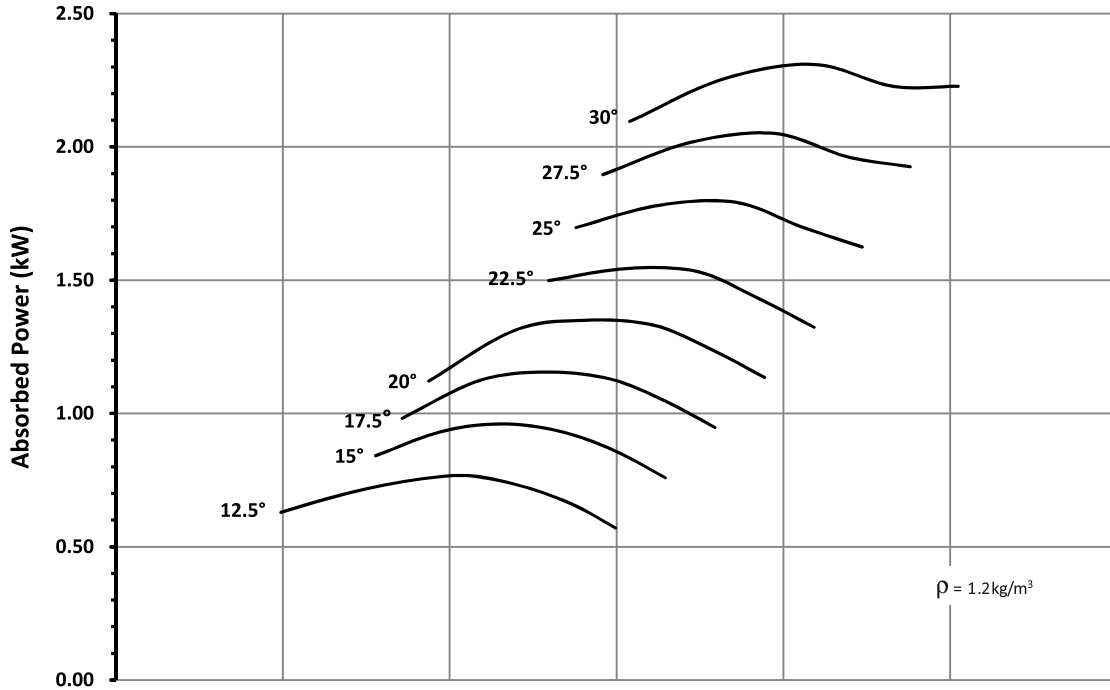

Ref	Full Octave Band Center Frequency							L _w A dB(A)	
	63	125	250	500	1K	2K	4K		8K
a	79	78	77	80	80	78	79	77	86
b	76	77	76	79	79	77	77	76	85
c	83	78	80	87	89	86	80	76	93
d	86	81	88	97	90	86	80	75	96
e	85	85	88	84	83	80	79	77	89
f	84	85	81	83	82	81	79	76	88
g	84	84	81	83	83	82	80	76	89
h	83	84	81	84	85	84	80	76	90
j	89	87	85	86	86	84	81	78	90
k	88	86	85	85	85	84	81	77	90
m	89	87	84	84	85	84	81	77	90
n	88	87	86	86	87	85	81	78	91



Performance certified is for Installation type D: Ducted Inlet- Ducted Outlet. Performance ratings do not include the effects of appurtenances (accessories). Power rating kW is fan input power. The Sound Power Level ratings shown are in decibels, referred to 10⁻¹² watts, calculated per AMCA International Standard 301. Values shown are for inlet L_w and L_wA sound power levels for Installation type D: Ducted Inlet-Ducted Outlet. Ratings include the effects of duct end correction. The A-weighted sound ratings shown have been calculated per AMCA International Standard 301.

Performance Curve FEG 60

ADTA 710-230-12
ADTA-F 710-230-12

50Hz 1440 rpm

Outlet Area: 0.396 m²

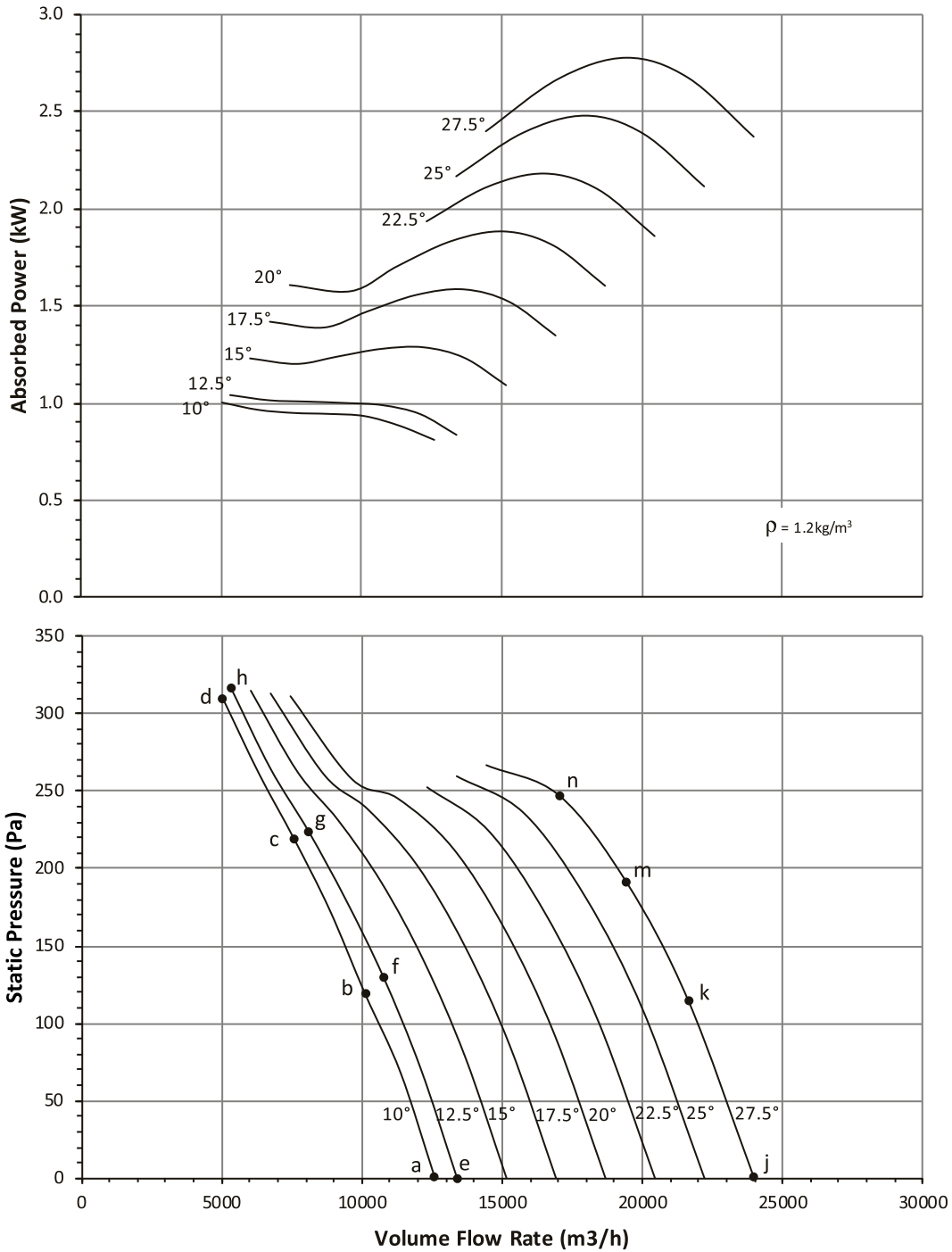

4 Pole - 1440 rpm

Ref	Full Octave Band Center Frequency								L _{WA} dB(A)
	63	125	250	500	1K	2K	4K	8K	
a	89	81	84	86	88	87	84	80	93
b	89	81	84	92	93	89	84	78	96
c	94	86	96	94	91	87	81	74	96
d	98	85	91	86	84	82	79	72	90
e	88	81	84	86	87	86	85	80	93
f	88	81	84	93	92	89	84	78	96
g	94	86	97	94	92	87	81	74	96
h	99	86	91	86	84	82	78	72	90
j	90	80	90	86	86	83	83	80	91
k	91	81	91	88	86	83	83	80	92
m	92	85	91	95	90	84	84	79	96
n	95	93	97	95	94	84	84	77	98



Performance certified for Installation type D: Ducted Inlet- Ducted Outlet. Performance ratings do not include the effects of appurtenances (accessories). Power rating kW is fan input power. The Sound Power Level ratings shown are in decibels, referred to 10⁻¹² watts, calculated per AMCA International Standard 301. Values shown are for inlet L_{WA} and L_{WA} sound power levels for Installation type D: Ducted Inlet-Ducted Outlet. Ratings include the effects of duct end correction. The A-weighted sound ratings shown have been calculated per AMCA International Standard 301.

Performance Curve FEG 71

ADTA 710-250-12
ADTA-F 710-250-12

50Hz 1440rpm

Outlet Area: 0.396 m²

4 Pole - 1440 rpm

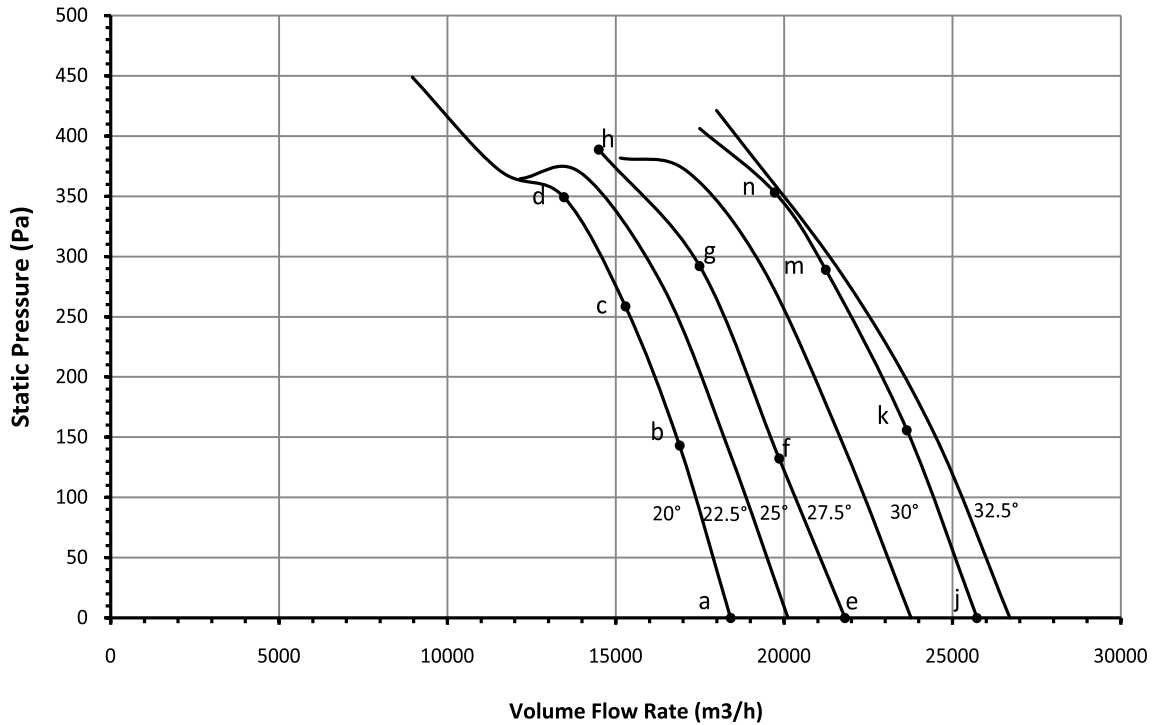
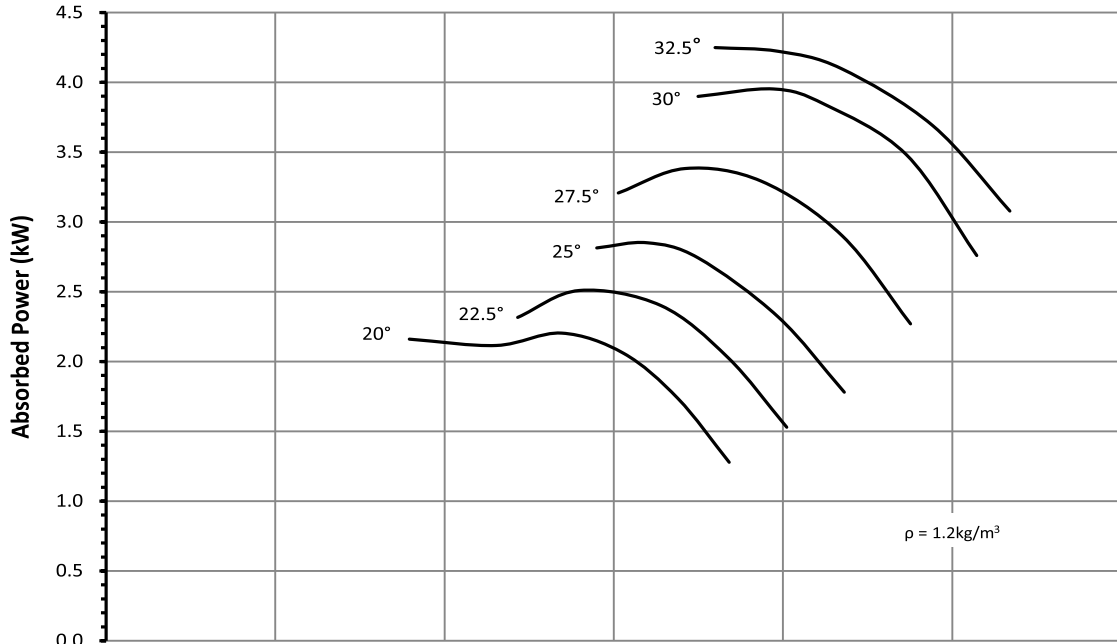

Ref	Full Octave Band Center Frequency								L _W A
	63	125	250	500	1K	2K	4K	8K	
a	91	80	86	86	84	83	82	73	90
b	91	79	85	84	83	82	81	73	89
c	86	80	85	87	85	84	80	73	90
d	88	85	89	96	91	87	81	74	96
e	89	82	86	86	85	83	82	75	91
f	90	82	86	85	84	83	81	76	90
g	90	82	86	87	85	83	79	77	90
h	93	93	95	96	91	87	81	78	97
j	91	84	87	88	87	84	83	85	92
k	92	83	88	87	85	83	80	80	90
m	92	82	89	86	85	83	78	76	90
n	93	88	92	89	87	84	80	77	92



Performance certified is for Installation type D: Ducted Inlet- Ducted Outlet. Performance ratings do not include the effects of appurtenances (accessories) Power rating kW is fan input power. The Sound Power Level ratings shown are in decibels, referred to 10-12 watts, calculated per AMCA International Standard 301. Values shown are for inlet LWi and LWiA sound power levels for Installation type D: Ducted Inlet-Ducted Outlet. Ratings include the effects of duct end correction. The A-weighted sound ratings shown have been calculated per AMCA International Standard 301.

Performance Curve FEG 71

ADTA 800-250-12
ADTA-F 800-250-12

50Hz 1440 rpm

Outlet Area: 0.503 m²

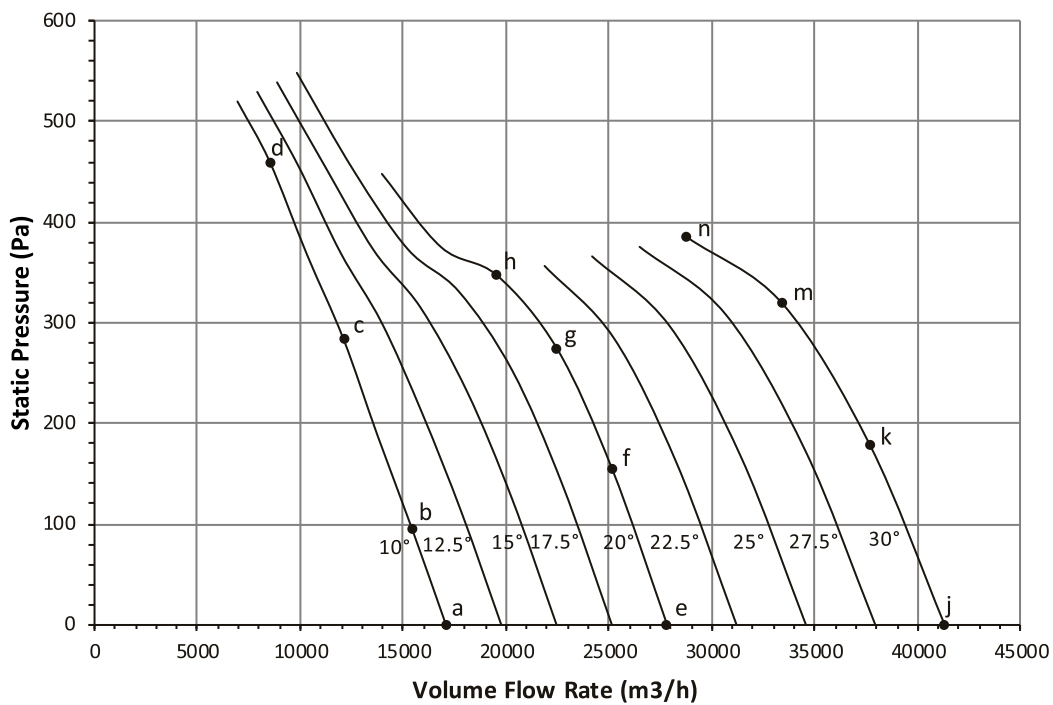
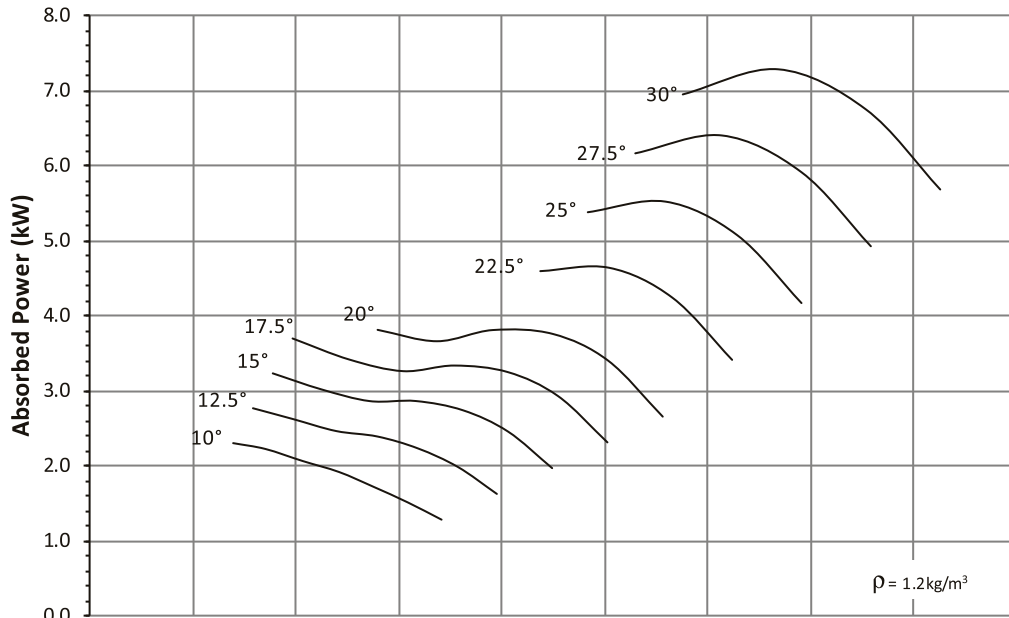

Ref	Full Octave Band Center Frequency								L _w A dB(A)
	63	125	250	500	1K	2K	4K	8K	
a	89	83	91	90	90	88	90	76	96
b	89	83	90	91	96	92	90	76	99
c	93	91	99	99	95	90	85	72	100
d	98	93	99	93	91	86	80	71	96
e	90	83	93	90	89	89	92	76	96
f	90	84	93	90	90	90	91	77	97
g	93	89	94	96	96	93	89	78	100
h	95	99	102	98	97	92	84	76	101
j	90	86	94	92	91	89	90	76	97
k	89	86	93	91	91	89	86	78	96
m	90	92	94	93	93	90	86	80	97
n	93	108	99	98	98	93	87	80	102



Performance certified is for Installation type D: Ducted Inlet - Ducted Outlet. Performance ratings do not include the effects of appurtenances (accessories) Power rating kW is fan input power. The Sound Power Level ratings shown are in decibels, referred to 10⁻¹² watts, calculated per AMCA International Standard 301. Values shown are for inlet L_w and L_wA sound power levels for Installation type D: Ducted Inlet-Ducted Outlet. Ratings include the effects of duct end correction. The A-weighted sound ratings shown have been calculated per AMCA International Standard 301.

4 Pole - 1440 rpm

Performance Curve FEG 75

ADTA 800-250-12-T
ADTA-F 800-250-12-T

50Hz 1440rpm

Outlet Area: 0.503 m²

4 Pole - 1440 rpm

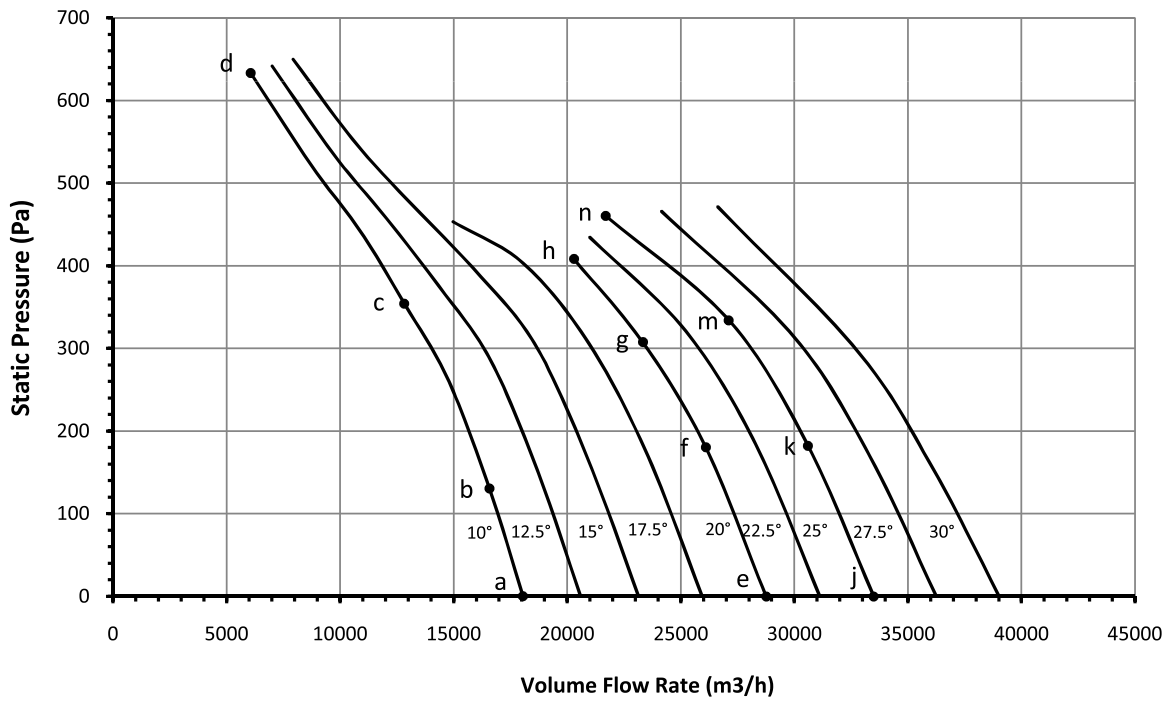
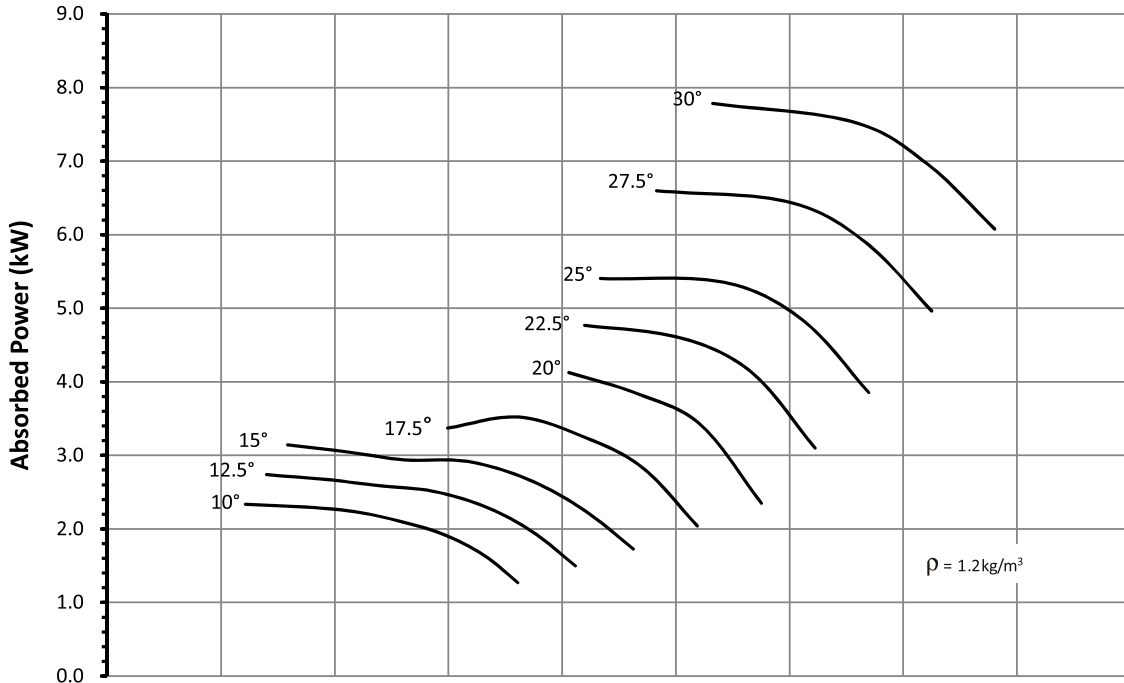

Ref	Full Octave Band Center Frequency								L _W A dB(A)
	63	125	250	500	1K	2K	4K	8K	
a	89	85	90	88	87	86	86	76	93
b	89	85	89	87	87	88	87	77	94
c	88	86	94	95	95	89	83	74	98
d	93	88	97	90	87	83	79	75	93
e	90	86	95	92	89	86	86	78	95
f	88	85	93	90	89	86	86	78	94
g	88	86	93	95	94	91	87	80	98
h	91	91	97	99	96	91	85	79	100
j	92	87	97	92	90	87	87	94	97
k	91	86	96	91	89	86	85	94	97
m	91	86	94	93	91	88	85	93	97
n	93	101	98	100	96	91	86	87	101



Performance certified is for Installation type D: Ducted Inlet- Ducted Outlet. Performance ratings do not include the effects of appurtenances (accessories) Power rating kW is fan input power. The Sound Power Level ratings shown are in decibels, referred to 10-12 watts, calculated per AMCA International Standard 301. Values shown are for inlet LWi and LWiA sound power levels for Installation type D: Ducted Inlet-Ducted Outlet. Ratings include the effects of duct end correction. The A-weighted sound ratings shown have been calculated per AMCA International Standard 301.

Performance Curve FEG 60

ADTA 900-400-08
ADTA-F 900-400-08

50Hz 1440 rpm

Outlet Area: 0.636 m²

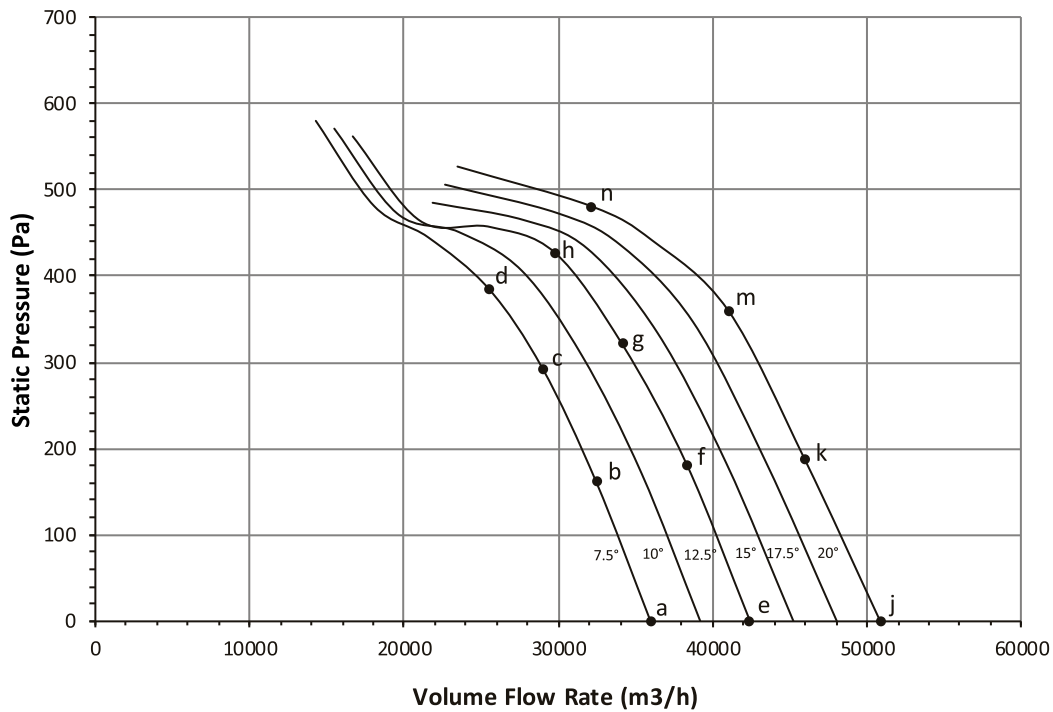
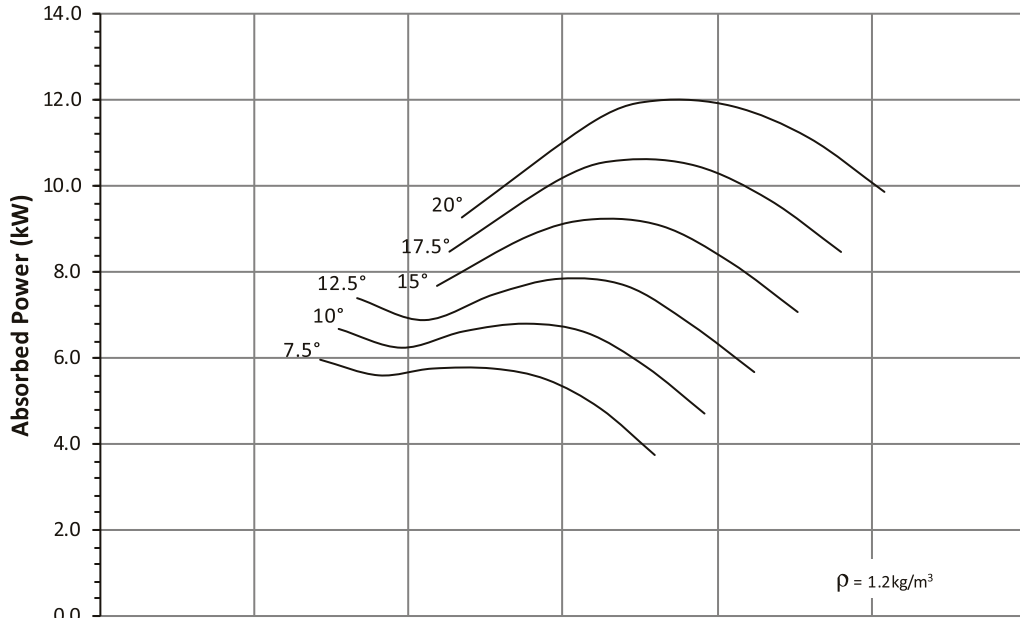

Ref	Full Octave Band Center Frequency								L _w A dB(A)
	63	125	250	500	1K	2K	4K	8K	
a	92	88	94	95	90	86	86	82	96
b	87	88	92	96	90	87	85	80	96
c	89	89	92	97	93	90	88	82	98
d	91	94	97	102	99	95	89	82	103
e	91	89	95	96	91	87	85	81	97
f	91	90	94	95	91	87	85	79	96
g	91	92	94	96	93	90	88	82	98
h	93	95	100	102	98	94	89	83	103
j	93	93	98	97	94	89	86	80	99
k	94	95	98	96	93	89	86	81	98
m	94	95	97	96	93	90	87	83	98
n	95	99	102	100	98	94	90	86	103



Performance certified is for Installation type D: Ducted Inlet- Ducted Outlet. Performance ratings do not include the effects of appurtenances (accessories). Power rating kW is fan input power. The Sound Power Level ratings shown are in decibels, referred to 10⁻¹² watts, calculated per AMCA International Standard 301. Values shown are for inlet L_w and L_wA sound power levels for Installation type D: Ducted Inlet-Ducted Outlet. Ratings include the effects of duct end correction. The A-weighted sound ratings shown have been calculated per AMCA International Standard 301.

4 Pole - 1440 rpm

4 Pole - 1440 rpm

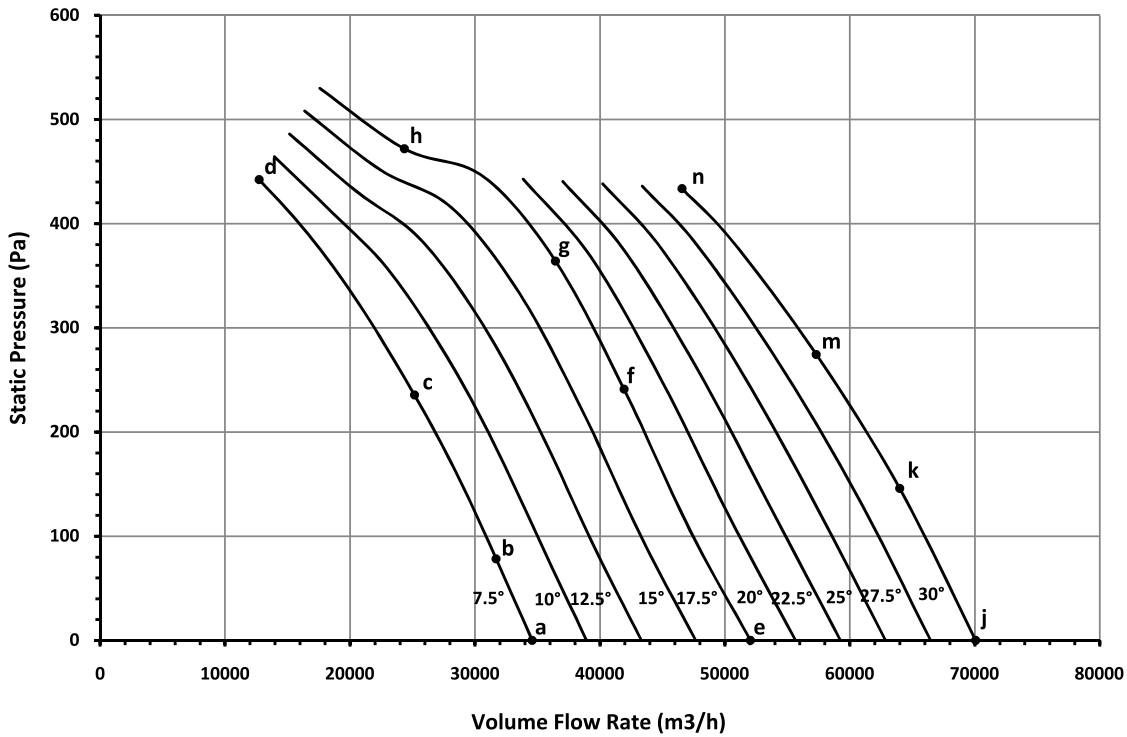
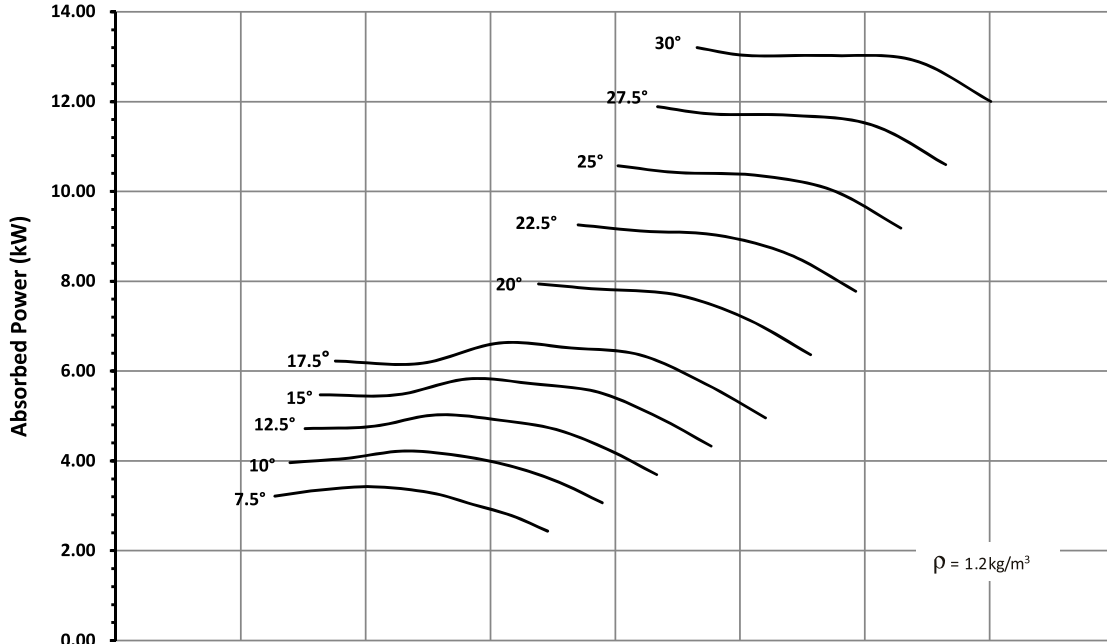

Ref	Full Octave Band Center Frequency								L _w (A) dB(A)
	63	125	250	500	1K	2K	4K	8K	
a	82	88	93	93	93	89	90	85	98
b	82	88	91	92	94	92	91	86	99
c	83	87	91	99	99	95	90	83	102
d	89	95	107	103	96	91	86	80	104
e	93	92	95	95	92	88	89	86	98
f	92	90	93	94	92	89	87	83	97
g	93	89	95	102	100	95	90	85	104
h	94	93	105	110	105	98	91	85	110
j	94	95	99	99	96	92	89	87	101
k	94	95	98	98	96	92	89	87	101
m	95	94	97	97	96	93	90	88	101
n	96	95	99	100	98	95	91	89	103



Performance certified is for Installation type D: Ducted Inlet- Ducted Outlet. Performance ratings do not include the effects of appurtenances (accessories) Power rating kW is fan input power. The Sound Power Level ratings shown are in decibels, referred to 10⁻¹² watts, calculated per AMCA International Standard 301. Values shown are for inlet L_w and L_w(A) sound power levels for Installation type D: Ducted Inlet-Ducted Outlet. Ratings include the effects of duct end correction. The A-weighted sound ratings shown have been calculated per AMCA International Standard 301.

Performance Curve
FEG 63

ADTA 1000-400-08
ADTA-F 1000-400-08

50Hz 1440 rpm

Outlet Area: 0.785 m²

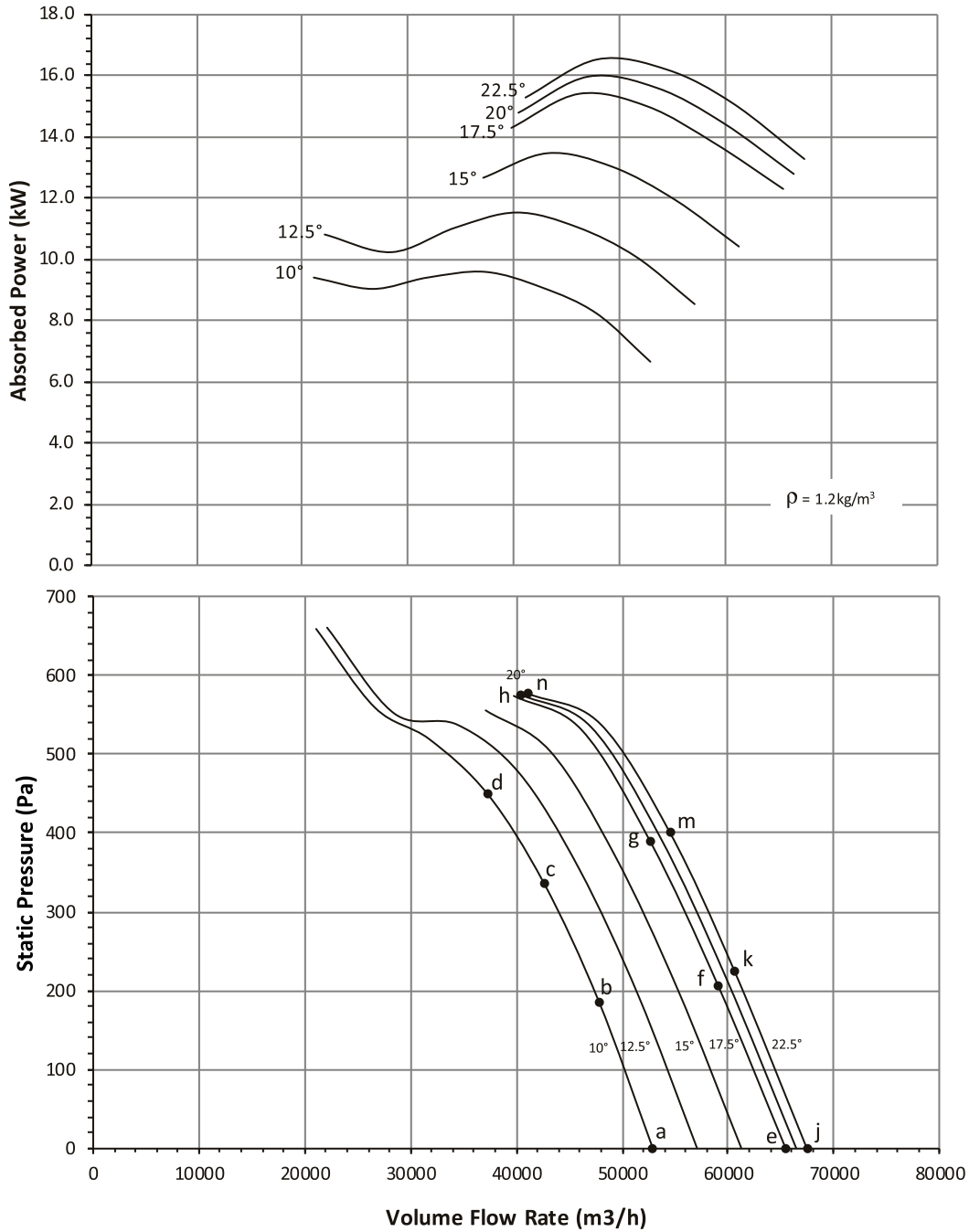

4 Pole - 1440 rpm

Ref	Full Octave Band Center Frequency								L _w A dB(A)
	63	125	250	500	1K	2K	4K	8K	
a	96	91	97	97	94	90	89	87	99
b	96	92	96	97	94	91	90	86	99
c	96	93	98	102	99	96	93	87	104
d	98	97	106	106	105	99	93	87	108
e	97	94	99	99	96	92	90	85	101
f	97	94	99	98	95	91	90	85	100
g	97	95	99	99	97	94	92	88	102
h	99	101	109	106	103	99	94	89	108
j	97	94	99	99	96	92	90	85	101
k	97	95	99	99	95	92	91	85	101
m	97	95	99	100	97	95	92	88	103
n	99	101	109	106	102	98	94	89	108



Performance certified is for Installation type D: Ducted Inlet- Ducted Outlet. Performance ratings do not include the effects of appurtenances (accessories)
Power rating kW is fan input power.
The Sound Power Level ratings shown are in decibels, referred to 10⁻¹² watts, calculated per AMCA International Standard 301. Values shown are for inlet L_w and L_wA sound power levels for Installation type D: Ducted Inlet-Ducted Outlet. Ratings include the effects of duct end correction.
The A-weighted sound ratings shown have been calculated per AMCA International Standard 301.

4 Pole - 1440 rpm

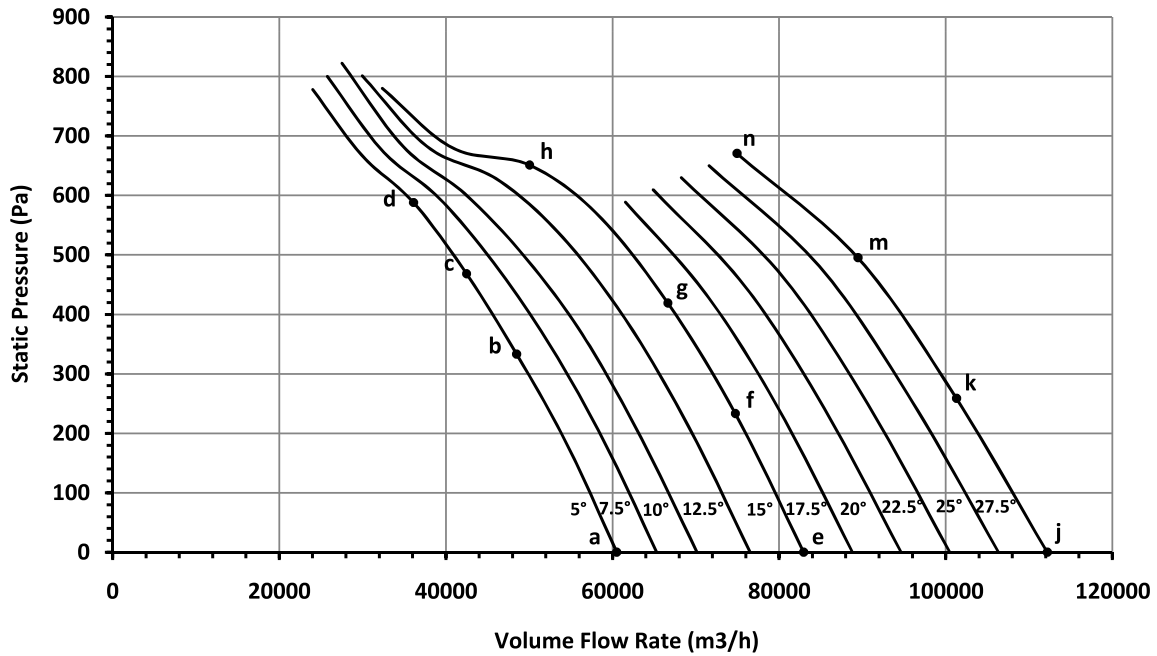
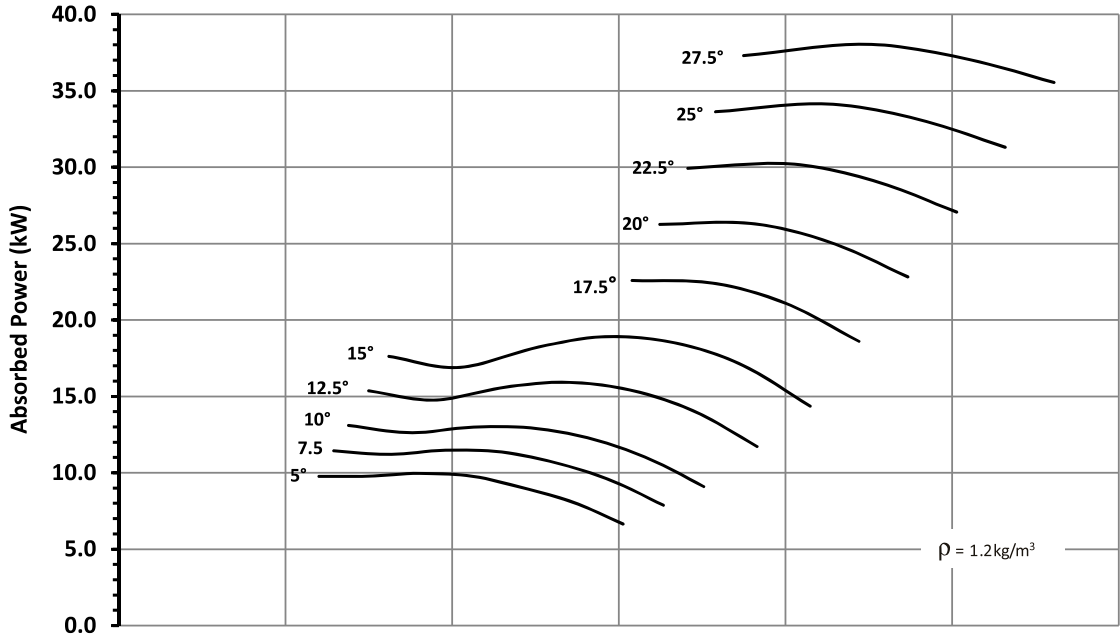

Ref	Full Octave Band Center Frequency							L _w , A dB(A)	
	63	125	250	500	1K	2K	4K		8K
a	100	91	96	99	98	94	92	92	102
b	96	91	99	105	106	103	98	91	109
c	97	95	106	106	106	101	96	89	110
d	99	101	108	106	104	99	94	88	108
e	105	95	102	99	98	93	91	89	103
f	102	94	100	98	97	94	93	89	102
g	104	96	102	102	102	99	97	92	106
h	106	113	112	107	105	100	96	90	110
j	110	108	104	102	101	97	94	92	106
k	113	110	105	102	101	98	95	93	106
m	110	108	105	101	101	98	96	94	106
n	108	109	110	106	105	101	97	93	110



Performance certified for Installation type D: Ducted Inlet- Ducted Outlet. Performance ratings do not include the effects of appurtenances (accessories) Power rating kW is fan input power. The Sound Power Level ratings shown are in decibels, referred to 10⁻¹² watts, calculated per AMCA International Standard 301. Values shown are for outlet L_{w0} and L_{w0A} sound power levels for Installation type D: Ducted Inlet-Ducted Outlet. Ratings include the effects of duct end correction. The A-weighted sound ratings shown have been calculated per AMCA International Standard 301.

Performance Curve FEG 75

ADTA 1250-400-08
ADTA-F 1250-400-08

50Hz 1440rpm

Outlet Area: 1.227 m²

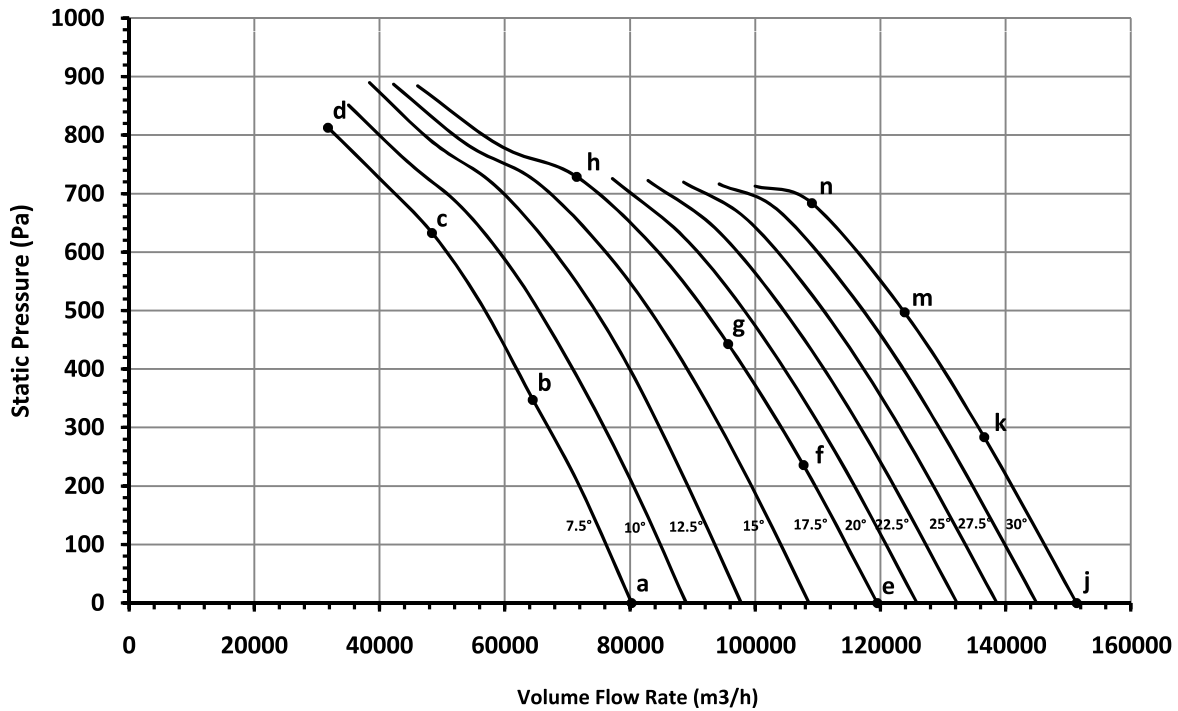
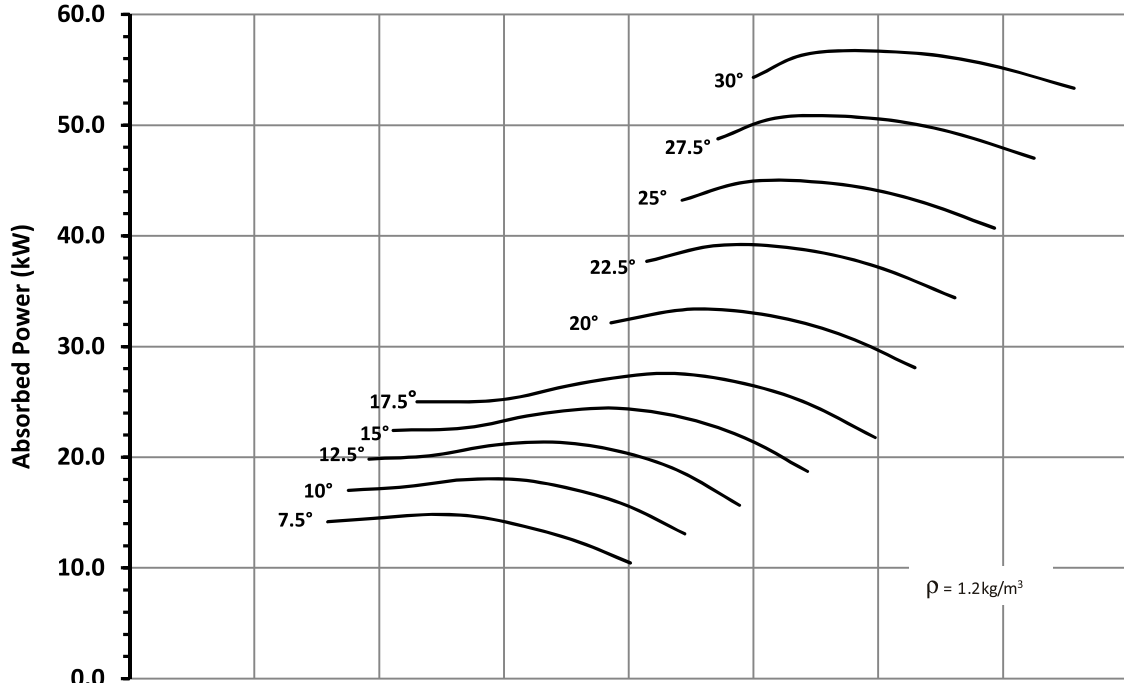

Ref	Full Octave Band Center Frequency								L _{WA} dB(A)
	63	125	250	500	1K	2K	4K	8K	
a	103	93	99	103	102	98	95	96	106
b	100	93	102	107	109	105	100	94	112
c	97	99	111	111	109	103	98	92	113
d	101	111	108	106	103	99	96	92	108
e	107	100	106	103	102	97	95	95	106
f	102	97	105	103	103	100	97	95	107
g	105	102	108	108	108	105	101	96	112
h	105	107	117	113	110	105	100	95	115
j	118	115	110	105	104	101	97	95	110
k	118	114	110	106	104	101	98	96	110
m	115	112	109	105	104	102	99	97	110
n	112	113	113	112	110	106	101	97	114



Performance certified for Installation type D: Ducted Inlet- Ducted Outlet. Performance ratings do not include the effects of appurtenances (accessories). Power rating kW is fan input power. The Sound Power Level ratings shown are in decibels, referred to 10⁻¹² watts, calculated per AMCA International Standard 301. Values shown are for outlet L_{wo} and L_{wa} sound power levels for Installation type D: Ducted Inlet-Ducted Outlet. Ratings include the effects of duct end correction. The A-weighted sound ratings shown have been calculated per AMCA International Standard 301.

4 Pole - 1440 rpm

Performance Curve FEG 75

ADTA 1250-400-12
ADTA-F 1250-400-12

50Hz 1440rpm

Outlet Area: 1.227 m²

4 Pole - 1440 rpm

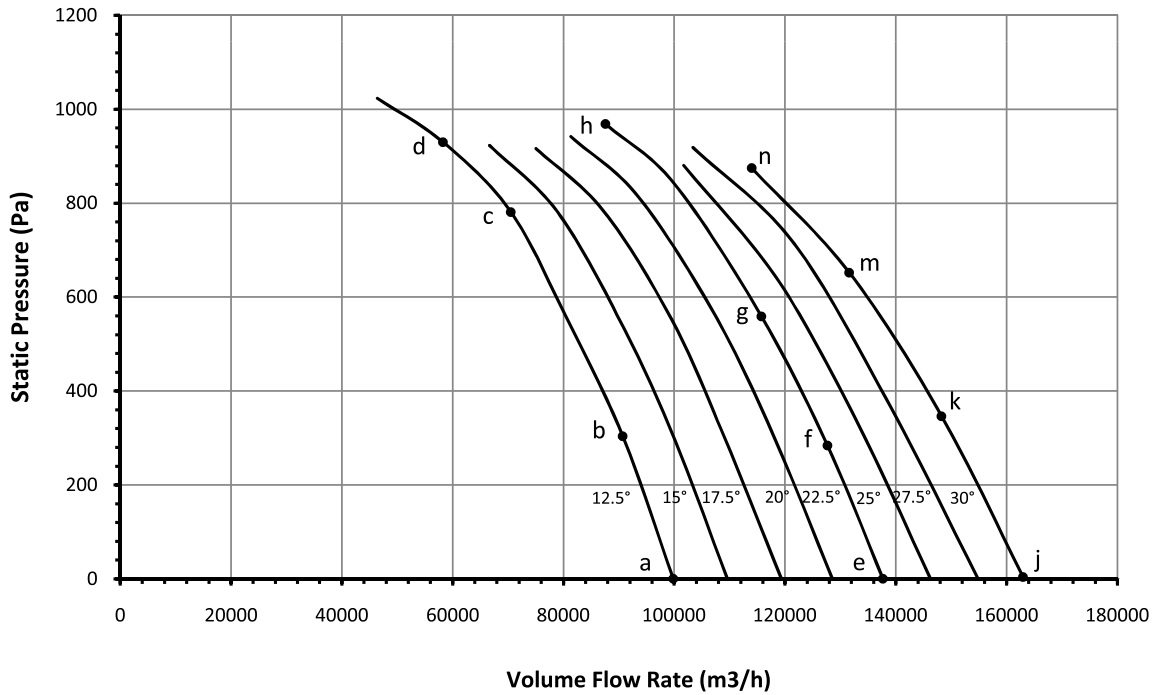
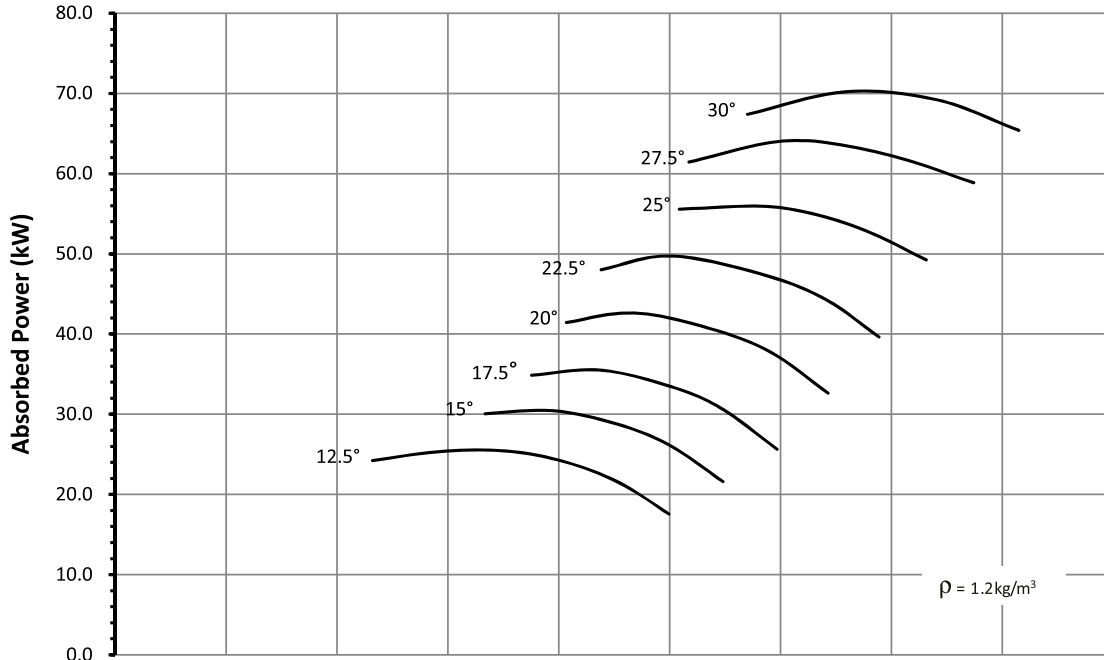

Ref	Full Octave Band Center Frequency								L _W oA
	63	125	250	500	1K	2K	4K	8K	
a	105	102	105	103	102	100	99	96	107
b	104	101	104	103	102	102	101	96	109
c	101	102	113	112	109	105	100	94	114
d	106	107	117	113	107	104	99	93	114
e	111	107	107	105	103	100	98	95	108
f	112	108	106	105	102	100	98	95	108
g	108	105	106	105	104	102	99	96	109
h	107	110	115	112	111	107	102	97	117
j	113	109	107	106	104	102	99	96	109
k	114	110	107	106	105	102	99	97	110
m	110	108	108	108	106	104	101	98	113
n	110	114	116	113	112	109	104	99	116



Performance certified is for Installation type D: Ducted Inlet- Ducted Outlet. Performance ratings do not include the effects of appurtenances (accessories)
Power rating kW is fan input power.
The Sound Power Level ratings shown are in decibels, referred to 10-12 watts, calculated per AMCA International Standard 301. Values shown are for outlet L_{wo} and L_{woA} sound power levels for Installation type D: Ducted Inlet-Ducted Outlet. Ratings include the effects of duct end correction.
The A-weighted sound ratings shown have been calculated per AMCA International Standard 301.

Performance Curve
FEG 67

ADTA 1400-400-08
ADTA-F 1400-400-08

50Hz 1440rpm

Outlet Area: 1.550 m²

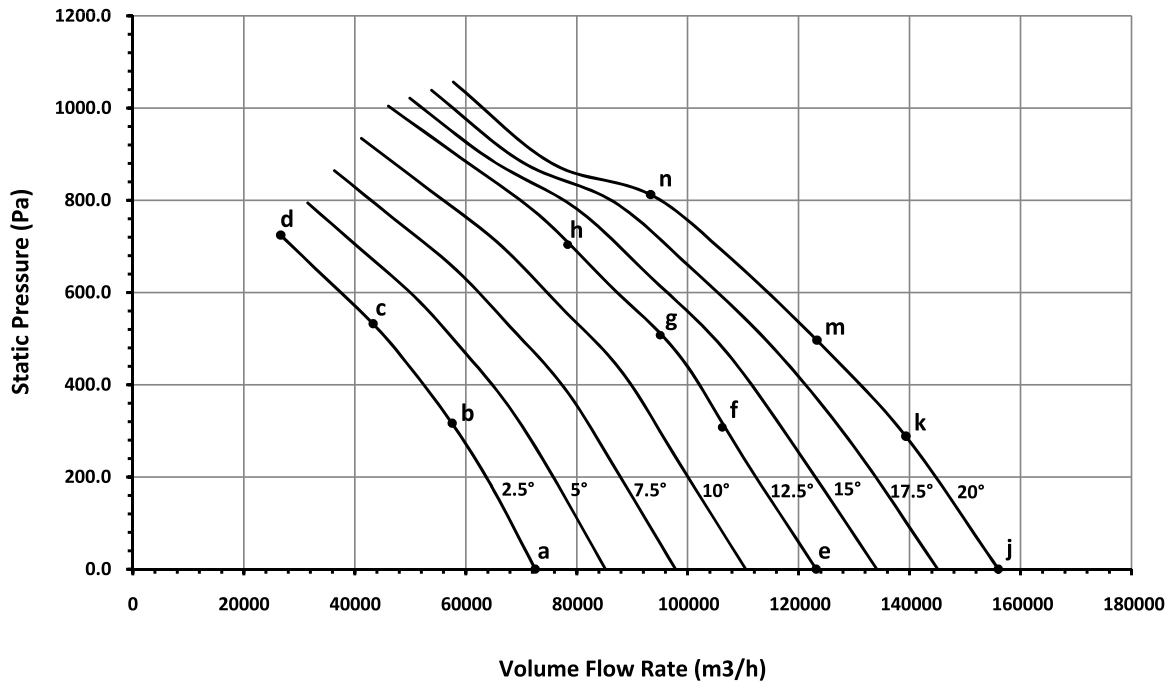
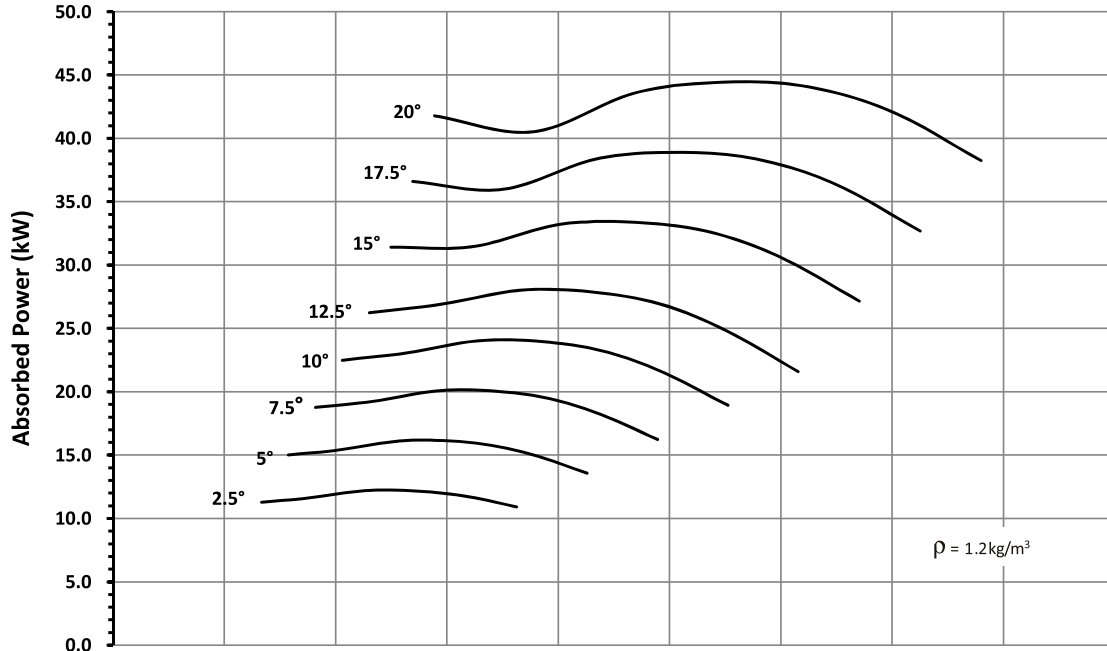

Ref	Full Octave Band Center Frequency								L _w A db(A)
	63	125	250	500	1k	2k	4k	8k	
a	98	98	100	107	107	104	101	98	111
b	98	98	105	110	107	103	99	95	112
c	101	101	109	107	103	101	97	92	109
d	104	104	105	101	99	98	95	92	105
e	101	101	101	101	106	108	104	100	112
f	101	101	101	104	106	108	104	99	112
g	101	101	104	109	109	108	102	98	114
h	101	101	112	112	109	106	101	97	114
j	104	104	107	103	106	108	104	99	113
k	102	102	106	107	109	109	104	99	114
m	103	103	107	112	112	109	104	100	116
n	116	116	114	111	107	106	102	98	114



Performance certified is for Installation type A: Free Inlet-Free Outlet. Performance ratings do not include the effects of appurtenances (accessories). Power rating kW is fan input power. The Sound Power Level ratings shown are in decibels, referred to 10⁻¹² watts, calculated per AMCA International Standard 301. Values shown are for outlet L_w and L_wA sound power levels for Installation type A: Free Inlet - Free Outlet. The A-weighted sound ratings shown have been calculated per AMCA International Standard 301.

4 Pole - 1440 rpm

Performance Curve FEG 60

ADTA 1400-400-12
ADTA-F 1400-400-12

50Hz 1440 rpm

Outlet Area: 1.550 m²

4 Pole - 1440 rpm

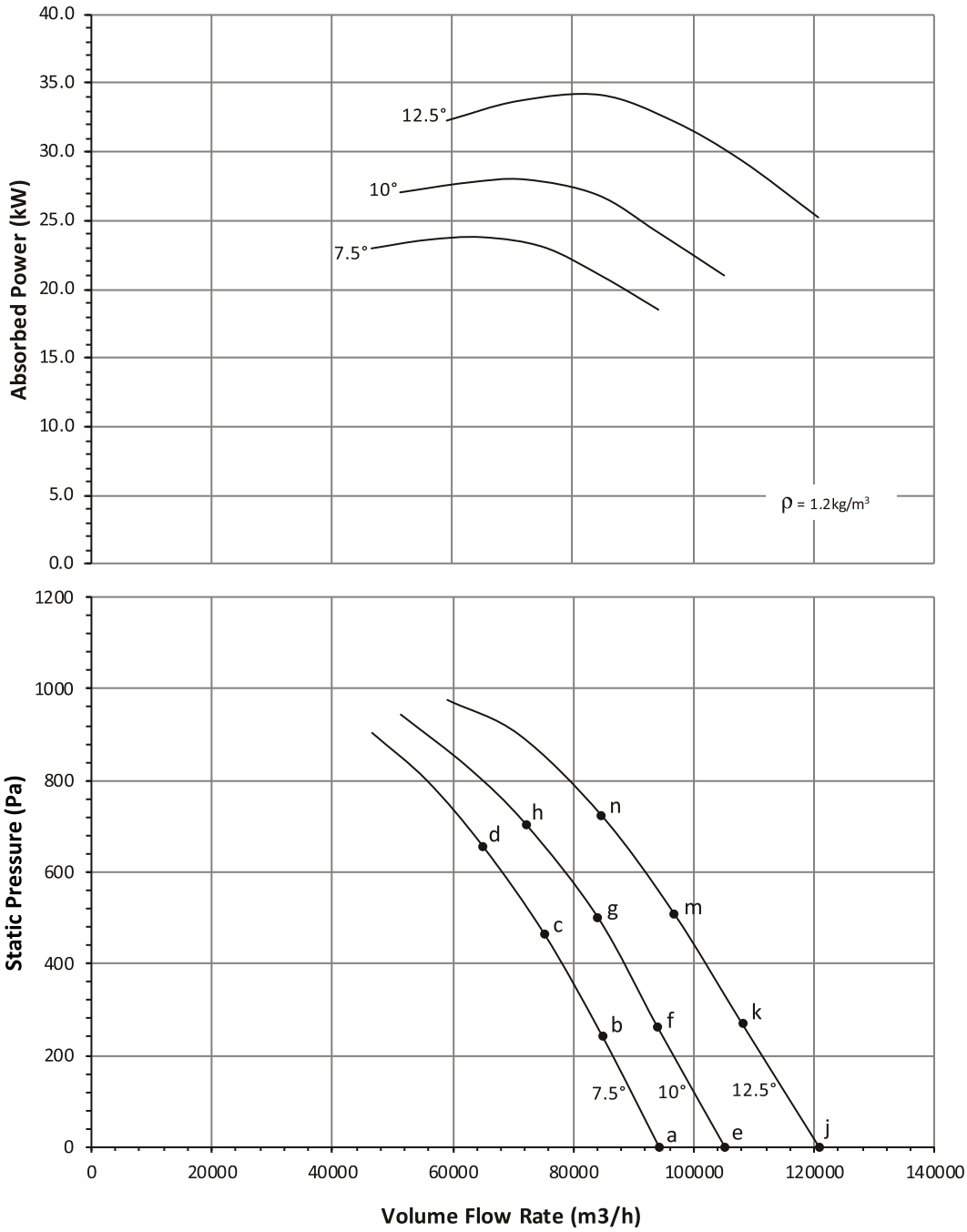

Ref	Full Octave Band Center Frequency								L _{WA} dB(A)
	63	125	250	500	1K	2K	4K	8K	
a	96	96	104	106	109	108	103	101	113
b	97	97	107	109	111	108	103	98	115
c	100	100	110	111	111	107	102	97	115
d	101	101	112	112	109	106	101	95	114
e	99	99	104	105	109	109	104	101	114
f	101	101	108	108	112	109	103	99	115
g	101	101	112	111	112	108	103	97	116
h	102	102	112	112	110	107	102	96	115
j	99	99	103	104	108	110	106	102	114
k	100	100	108	108	112	110	104	99	116
m	102	102	114	112	113	109	103	98	117
n	104	104	114	113	111	108	103	97	116



Performance certified for Installation type A: Free Inlet-Free Outlet. Performance ratings do not include the effects of appurtenances (accessories). Power rating kW is fan input power. The Sound Power Level ratings shown are in decibels, referred to 10⁻¹² watts, calculated per AMCA International Standard 301. Values shown are for outlet L_{wo} and L_{WA} sound power levels for Installation type A: Free Inlet - Free Outlet. The A-weighted sound ratings shown have been calculated per AMCA International Standard 301.

Performance Curve
FEG 56

ADTA 315-110-05
ADTA-F 315-110-05

50Hz 960rpm

Outlet Area: 0.079 m²

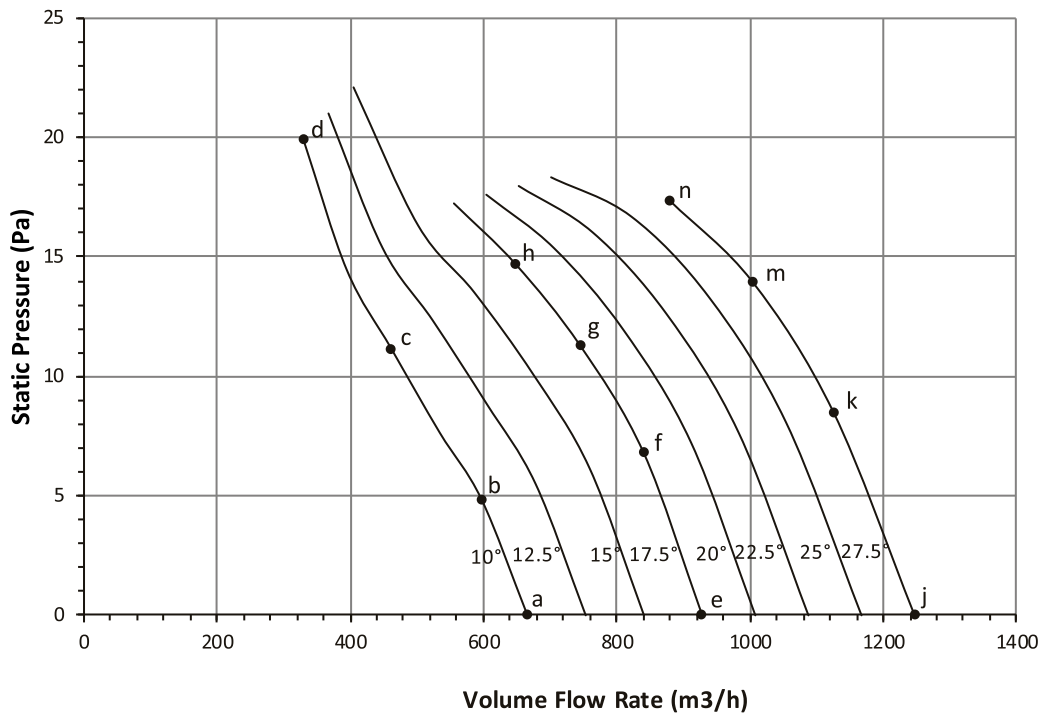
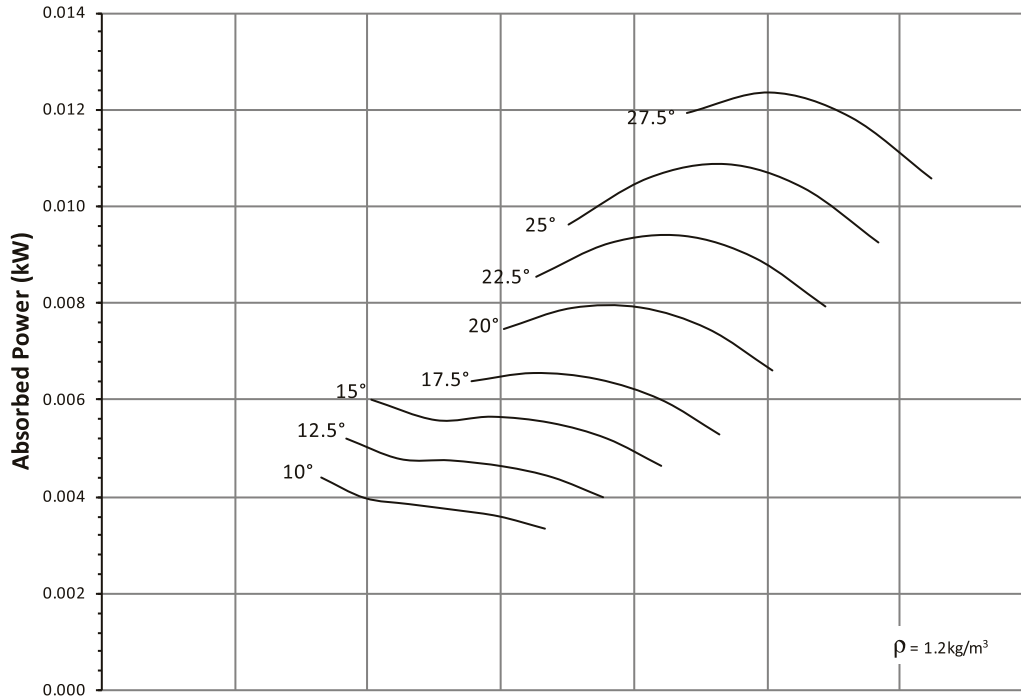

6 Pole - 960 rpm

Ref	Full Octave Band Center Frequency								L _w A dB(A)
	63	125	250	500	1K	2K	4K	8K	
a	55	53	53	52	50	47	44	41	55
b	55	53	54	53	50	46	42	38	55
c	59	62	62	57	51	45	41	36	59
d	64	59	55	51	48	44	40	36	54
e	56	51	51	52	50	47	43	39	55
f	55	50	52	51	49	47	44	41	54
g	57	56	57	55	51	48	45	42	57
h	62	63	63	59	53	48	43	38	60
j	55	52	54	52	49	47	44	41	55
k	58	52	53	52	49	48	45	42	55
m	59	54	55	54	50	49	48	47	57
n	61	58	57	55	51	49	48	47	57



Performance certified is for Installation type D: Ducted Inlet- Ducted Outlet. Performance ratings do not include the effects of appurtenances (accessories)
Power rating kW is fan input power.
The Sound Power Level ratings shown are in decibels, referred to 10⁻¹² watts, calculated per AMCA International Standard 301. Values shown are for inlet L_wi and L_wA sound power levels for Installation type D: Ducted Inlet-Ducted Outlet. Ratings include the effects of duct end correction.
The A-weighted sound ratings shown have been calculated per AMCA International Standard 301.

Performance Curve FEG 67

ADTA 400-160-10
ADTA-F 400-160-10

50Hz 960 rpm

Outlet Area: 0.129 m²

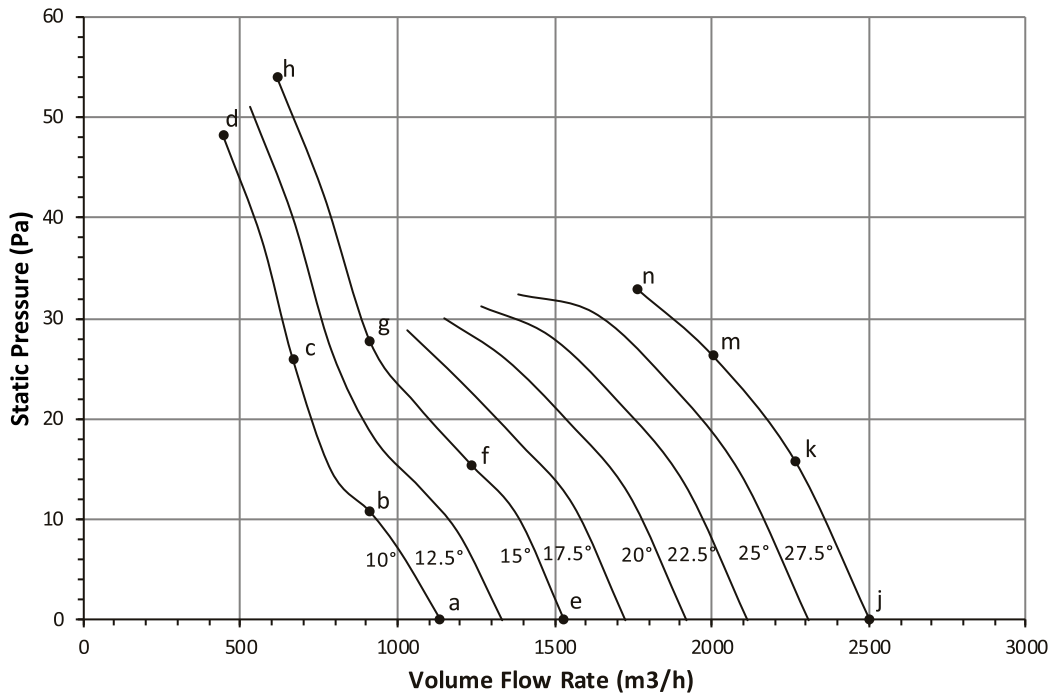
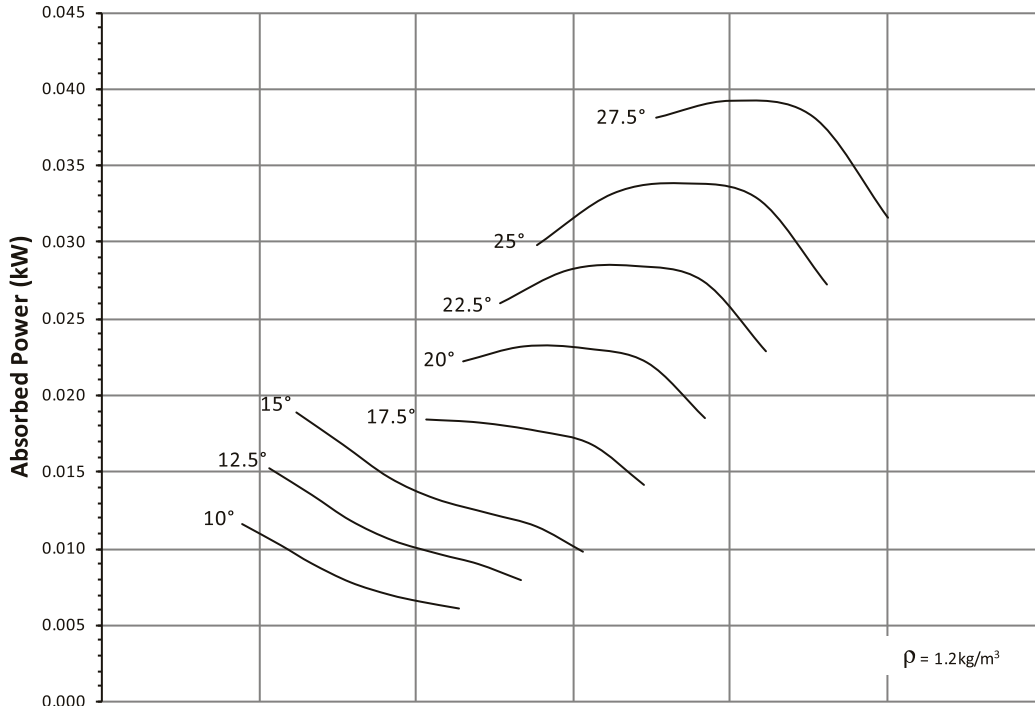

Ref	Full Octave Band Center Frequency								L _w A dB(A)
	63	125	250	500	1K	2K	4K	8K	
a	68	71	67	63	60	55	49	42	66
b	70	75	70	65	60	54	47	40	67
c	71	71	65	61	57	52	45	37	63
d	71	69	64	60	57	52	45	37	63
e	68	73	66	61	59	55	50	44	65
f	71	75	70	65	61	55	47	39	68
g	76	77	69	63	59	52	45	37	66
h	70	68	63	59	56	51	45	40	61
j	67	66	63	62	61	58	53	48	66
k	67	66	64	61	60	58	52	46	65
m	71	70	66	64	61	58	52	46	66
n	77	76	70	67	64	58	51	44	69



Performance certified is for Installation type D: Ducted Inlet- Ducted Outlet. Performance ratings do not include the effects of appurtenances (accessories)
Power rating kW is fan input power.
The Sound Power Level ratings shown are in decibels, referred to 10⁻¹² watts, calculated per AMCA International Standard 301. Values shown are for inlet L_w and L_wA sound power levels for Installation type D: Ducted Inlet-Ducted Outlet. Ratings include the effects of duct end correction.
The A-weighted sound ratings shown have been calculated per AMCA International Standard 301.

6 Pole - 960 rpm

Performance Curve
FEG 85

ADTA 500-160-10
ADTA-F 500-160-10

50Hz 960 rpm

Outlet Area: 0.200 m²

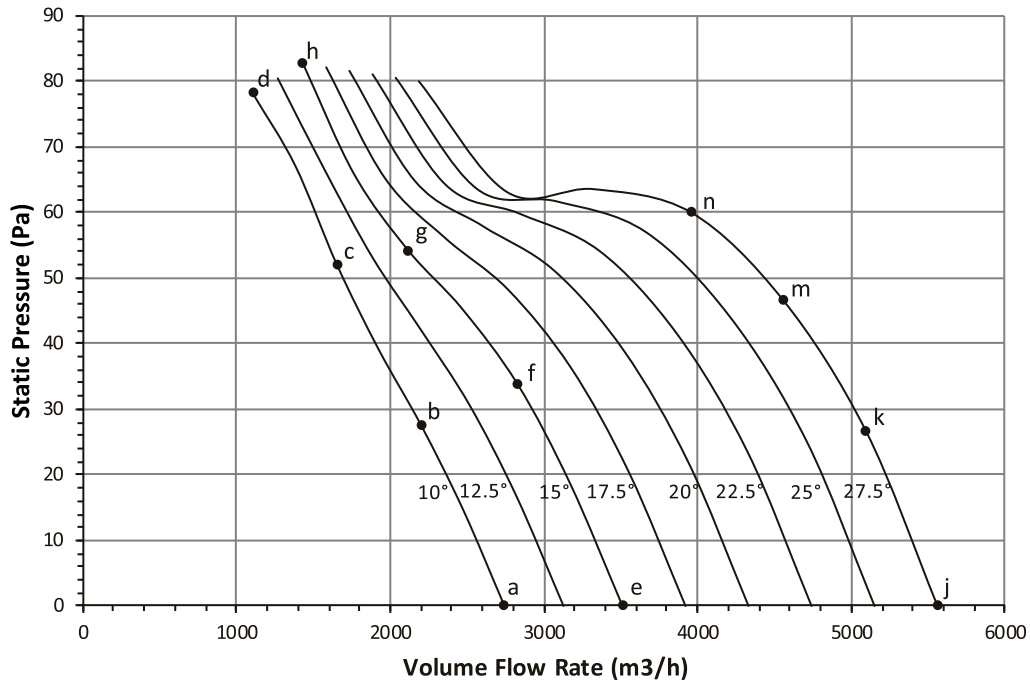
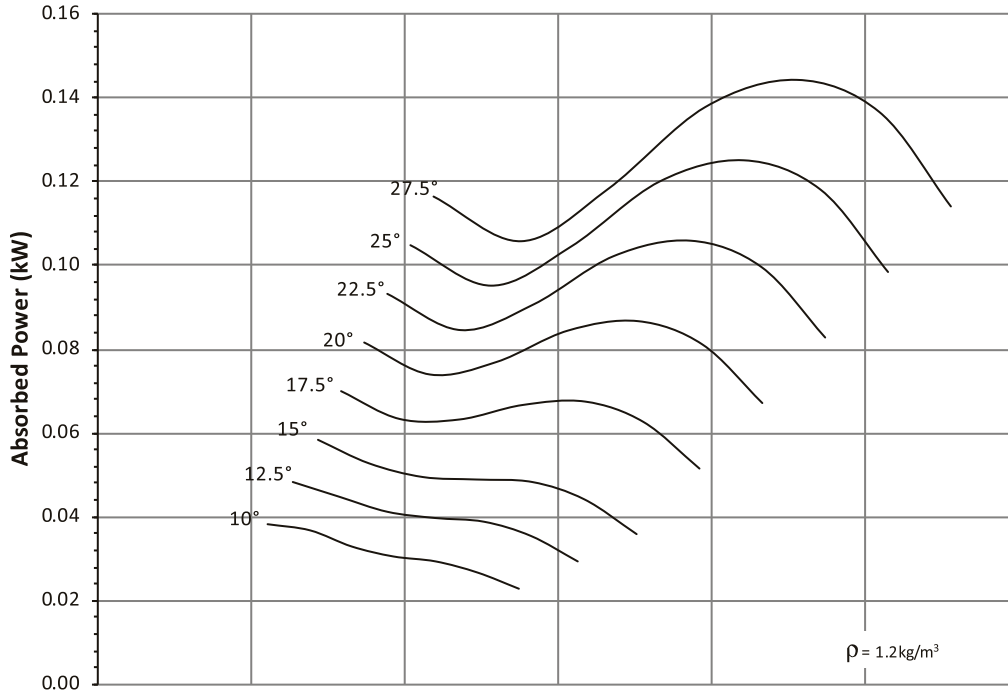

Ref	Full Octave Band Center Frequency								L _{WA} dB(A)
	63	125	250	500	1K	2K	4K	8K	
a	73	76	73	70	68	65	58	50	73
b	74	76	75	73	68	62	55	47	74
c	83	83	77	70	66	60	52	44	73
d	80	79	71	65	63	59	52	43	70
e	70	76	73	69	68	65	59	52	73
f	73	75	74	73	70	65	58	50	75
g	90	88	78	72	67	61	54	46	76
h	81	77	71	66	63	60	53	45	70
j	68	77	75	70	67	65	61	55	73
k	70	72	74	71	66	65	61	54	73
m	75	75	76	73	69	66	60	53	75
n	82	80	76	72	68	64	58	51	74



Performance certified is for Installation type D: Ducted Inlet- Ducted Outlet. Performance ratings do not include the effects of appurtenances (accessories) Power rating kW is fan input power. The Sound Power Level ratings shown are in decibels, referred to 10⁻¹² watts, calculated per AMCA International Standard 301. Values shown are for inlet L_{WA} and L_{WA} sound power levels for Installation type D: Ducted Inlet-Ducted Outlet. Ratings include the effects of duct end correction. The A-weighted sound ratings shown have been calculated per AMCA International Standard 301.

6 Pole - 960 rpm

Performance Curve FEG 67

ADTA 560-160-10
ADTA-F 560-160-10

50Hz 960 rpm

Outlet Area: 0.248 m²

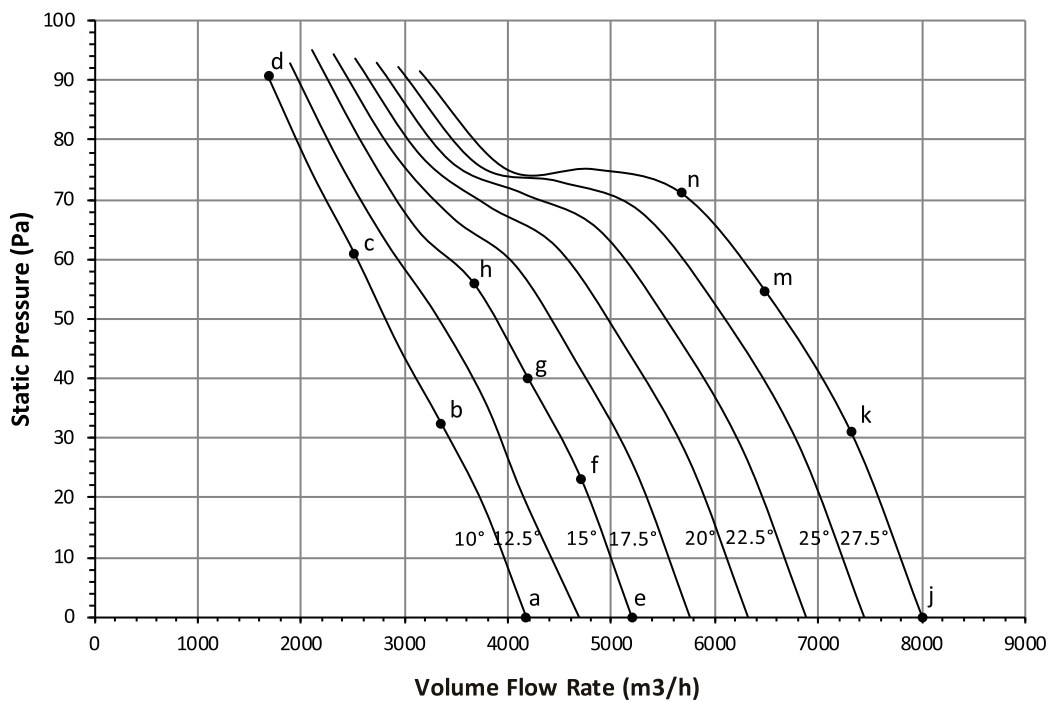
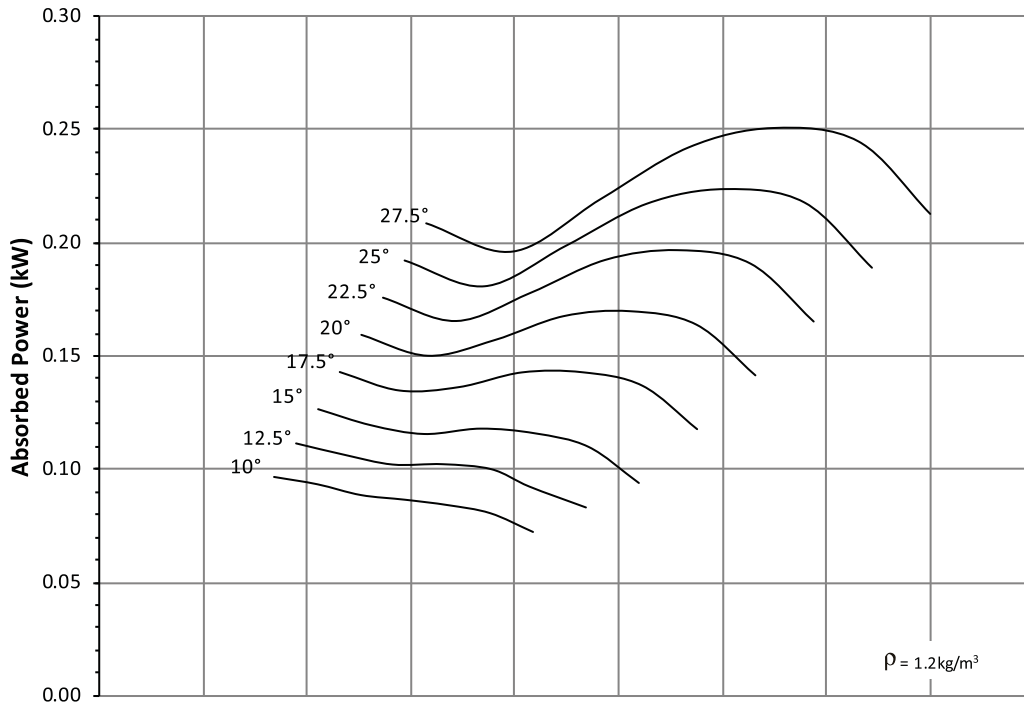

Ref	Full Octave Band Center Frequency								L _w A dB(A)
	63	125	250	500	1K	2K	4K	8K	
a	71	70	71	72	71	68	63	56	75
b	75	72	74	76	73	67	61	54	77
c	83	81	80	74	70	65	57	49	76
d	83	77	73	68	67	63	57	49	72
e	70	68	71	71	70	68	63	57	75
f	69	66	69	70	70	68	64	58	75
g	75	72	74	76	74	70	63	56	78
h	78	76	77	77	73	68	60	52	78
j	71	70	74	73	70	69	65	59	76
k	73	72	75	73	69	68	65	60	75
m	79	78	78	74	72	69	65	60	77
n	82	81	79	77	74	70	64	58	79



Performance certified is for Installation type D: Ducted Inlet- Ducted Outlet. Performance ratings do not include the effects of appurtenances (accessories) Power rating kW is fan input power. The Sound Power Level ratings shown are in decibels, referred to 10⁻¹² watts, calculated per AMCA International Standard 301. Values shown are for inlet L_w and L_wA sound power levels for Installation type D: Ducted Inlet-Ducted Outlet. Ratings include the effects of duct end correction. The A-weighted sound ratings shown have been calculated per AMCA International Standard 301.

6 Pole - 960 rpm

Performance Curve
FEG 90

ADTA 630-160-05
ADTA-F 630-160-05

50Hz 960rpm

Outlet Area: 0.312 m²

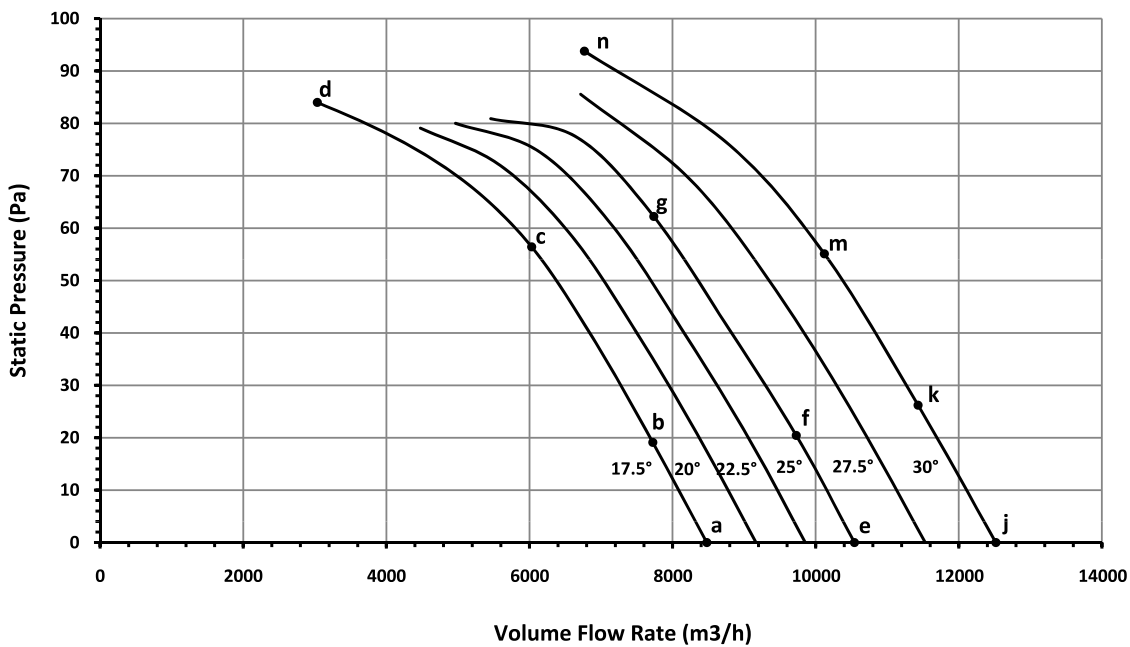
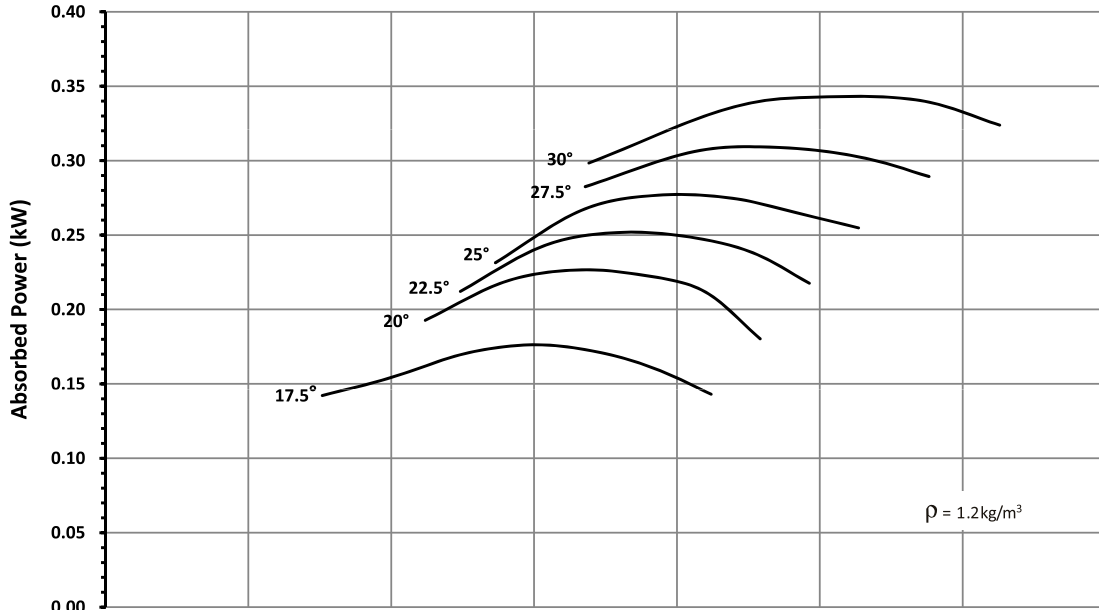

Ref	Full Octave Band Center Frequency							L _{WA} dB(A)	
	63	125	250	500	1K	2K	4K		8K
a	72	67	68	69	67	66	65	63	73
b	71	68	68	68	67	66	65	62	73
c	71	69	71	72	70	68	66	63	75
d	77	79	86	82	76	71	65	60	83
e	74	71	71	71	68	67	66	63	74
f	73	70	71	71	68	67	65	63	74
g	74	70	72	71	69	68	66	63	75
j	77	73	73	72	70	68	66	64	76
k	75	72	72	71	70	68	66	63	75
m	77	71	71	72	71	69	67	64	76
n	89	79	74	72	70	67	62	57	75



Performance certified is for Installation type D: Ducted Inlet- Ducted Outlet. Performance ratings do not include the effects of appurtenances (accessories). Power rating kW is fan input power. The Sound Power Level ratings shown are in decibels, referred to 10⁻¹² watts, calculated per AMCA International Standard 301. Values shown are for inlet L_{WA} and L_{WA} sound power levels for Installation type D: Ducted Inlet-Ducted Outlet. Ratings include the effects of duct end correction. The A-weighted sound ratings shown have been calculated per AMCA International Standard 301.

6 Pole - 960 rpm

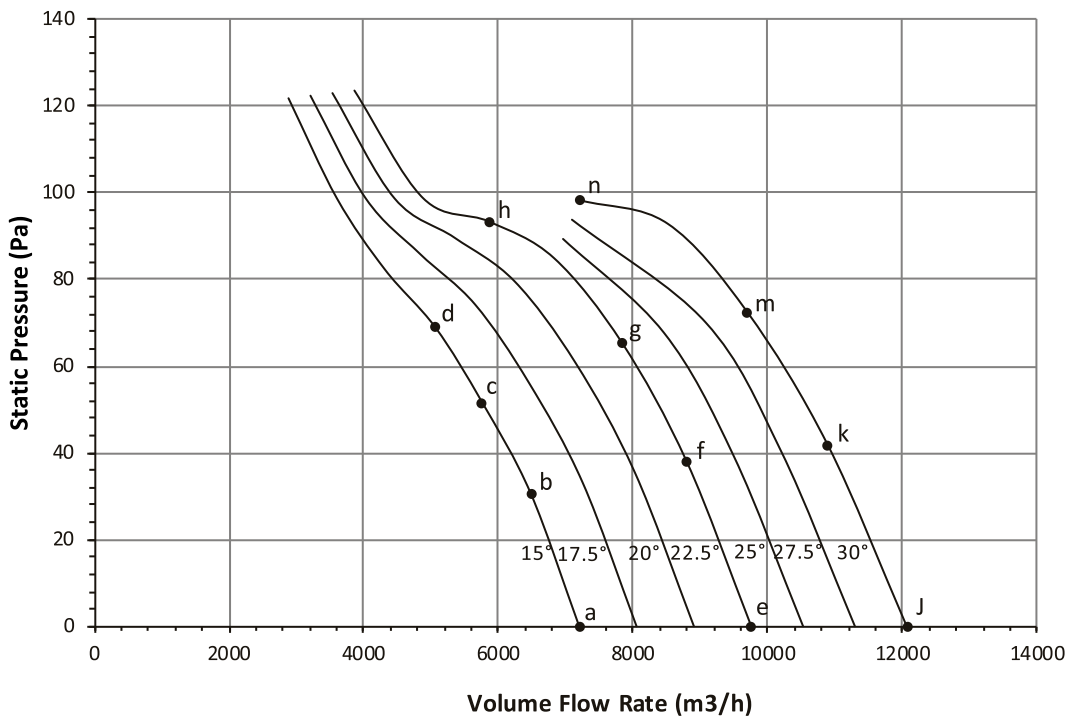
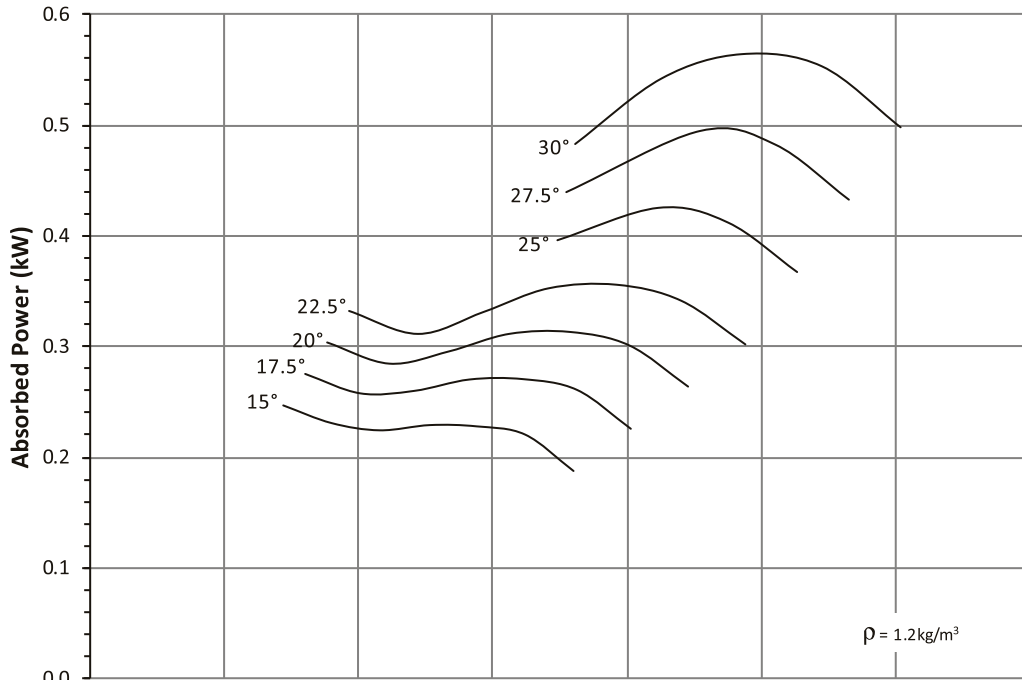

Ref	Full Octave Band Center Frequency								L _w A dB(A)
	63	125	250	500	1K	2K	4K	8K	
a	73	71	73	74	74	73	69	64	79
b	72	70	72	73	73	72	68	63	78
c	74	75	78	79	78	74	68	61	82
d	77	79	83	81	78	73	66	59	83
e	74	71	73	73	72	72	70	65	78
f	74	72	73	72	71	71	69	64	77
g	78	77	79	76	75	73	68	63	80
h	82	85	88	82	78	73	66	59	84
j	75	72	75	75	73	72	70	66	79
k	76	74	76	75	73	72	69	65	79
m	79	77	79	77	75	73	69	64	80
n	89	88	86	82	79	73	67	60	84



Performance certified for Installation type D: Ducted Inlet- Ducted Outlet. Performance ratings do not include the effects of appurtenances (accessories)
Power rating kW is fan input power.
The Sound Power Level ratings shown are in decibels, referred to 10⁻¹² watts, calculated per AMCA International Standard 301. Values shown are for inlet L_w and L_wA sound power levels for Installation type D: Ducted Inlet-Ducted Outlet. Ratings include the effects of duct end correction.
The A-weighted sound ratings shown have been calculated per AMCA International Standard 301.

Performance Curve FEG 60

ADTA 710-230-12
ADTA-F 710-230-12

50Hz 960 rpm

Outlet Area: 0.396 m²

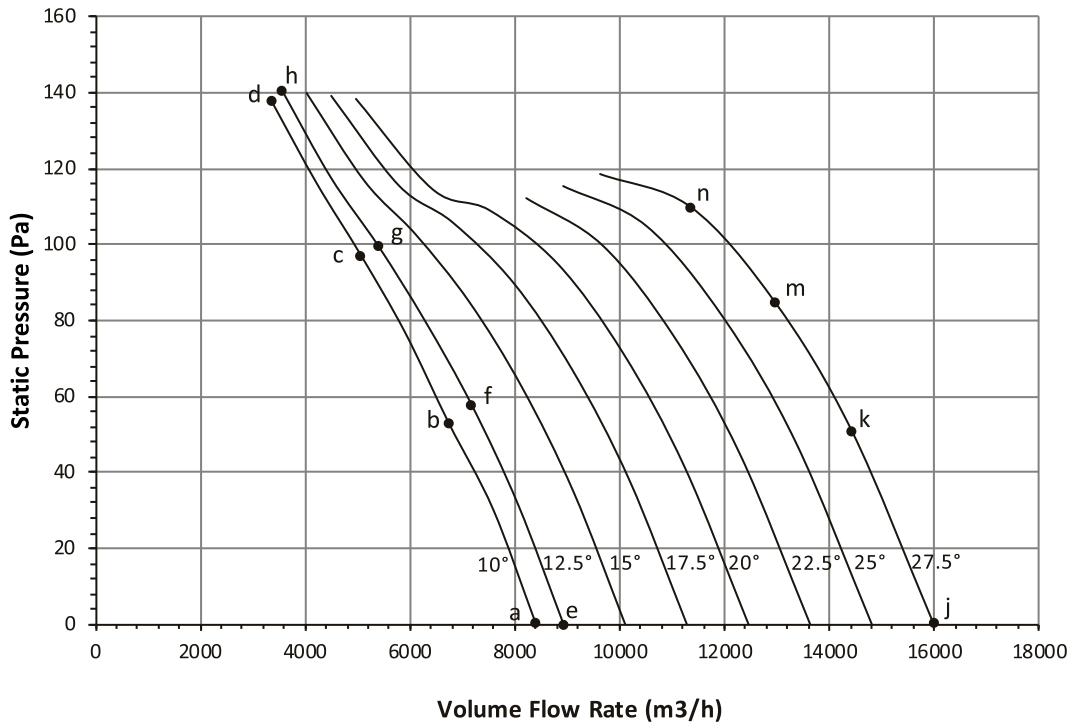
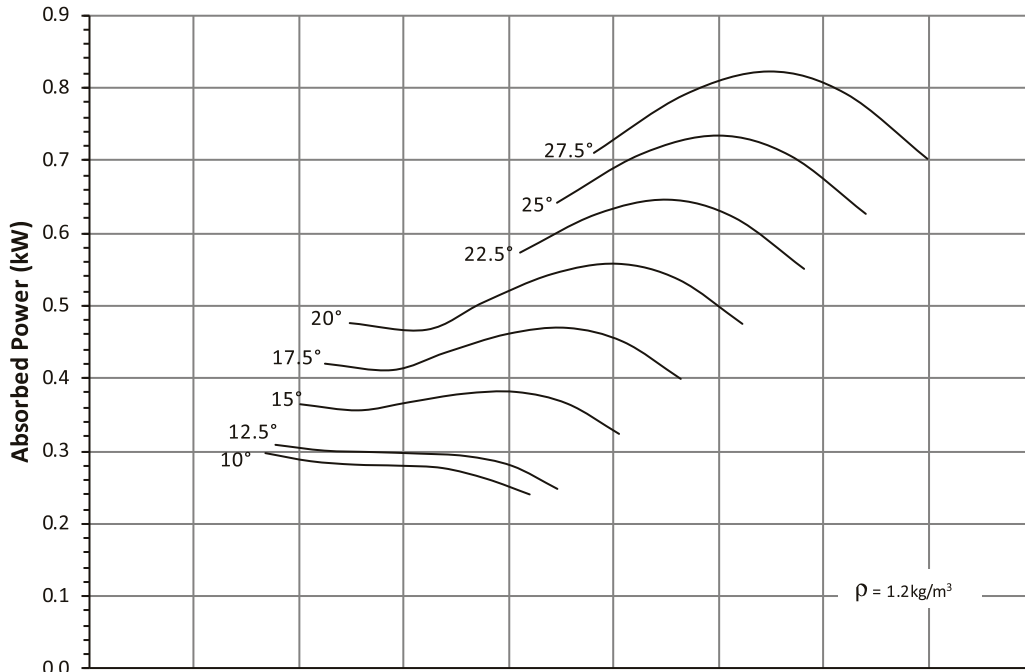

Ref	Full Octave Band Center Frequency								L _{WA} dB(A)
	63	125	250	500	1K	2K	4K	8K	
a	75	74	76	78	78	76	72	68	82
b	75	74	80	83	81	76	71	65	85
c	80	82	86	82	79	74	67	60	84
d	81	79	82	75	73	71	65	58	79
e	73	71	73	74	74	73	69	64	79
f	75	74	81	83	81	76	71	65	85
g	80	83	87	83	79	74	67	60	84
h	82	80	82	75	73	70	65	59	79
j	76	77	81	77	76	74	73	70	82
k	77	78	83	78	76	75	73	70	83
m	80	80	85	84	80	77	73	68	86
n	85	87	89	86	83	78	72	65	88



Performance certified for Installation type D: Ducted Inlet- Ducted Outlet. Performance ratings do not include the effects of appurtenances (accessories)
Power rating kW is fan input power.
The Sound Power Level ratings shown are in decibels, referred to 10⁻¹² watts, calculated per AMCA International Standard 301. Values shown are for inlet L_{wp} and L_{WA} sound power levels for Installation type D: Ducted Inlet-Ducted Outlet. Ratings include the effects of duct end correction.
The A-weighted sound ratings shown have been calculated per AMCA International Standard 301.

6 Pole - 960 rpm

Performance Curve FEG 71

ADTA 710-250-12
ADTA-F 710-250-12

50Hz 960 rpm

Outlet Area: 0.396 m²

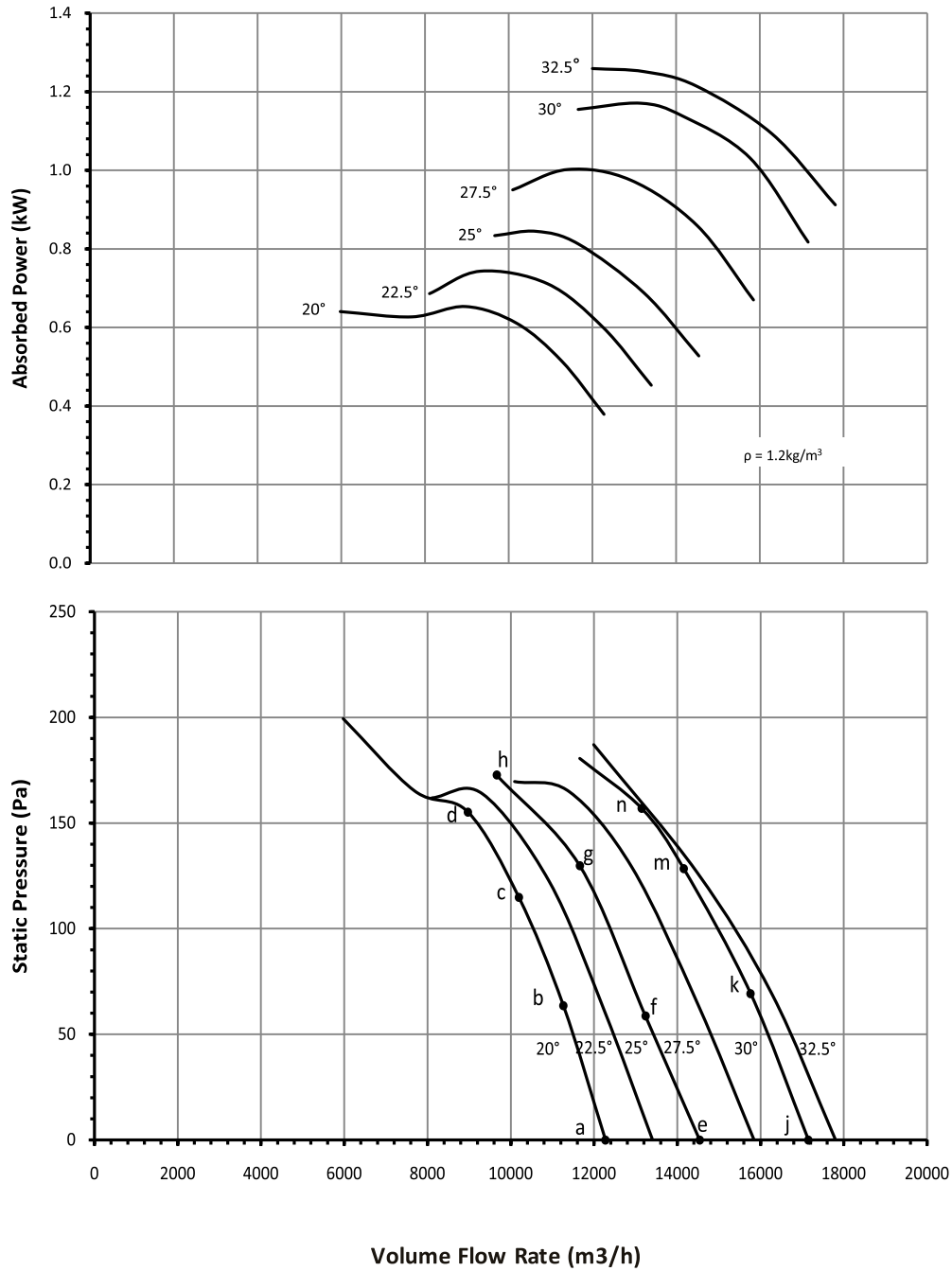

6 Pole - 960 rpm

Ref	Full Octave Band Center Frequency							L _W /A dB(A)	
	63	125	250	500	1K	2K	4K		8K
a	75	75	78	76	74	74	68	59	80
b	75	74	76	75	74	73	68	60	79
c	73	74	78	77	76	73	67	61	80
d	77	79	85	84	80	75	68	61	85
e	75	75	77	77	75	74	70	63	81
f	76	75	77	76	75	73	69	64	80
g	76	79	78	77	75	72	69	68	80
h	84	85	87	85	80	75	70	65	86
j	78	77	79	78	76	75	75	77	83
k	77	77	79	77	75	72	71	71	81
m	77	77	80	77	75	71	68	66	80
n	81	82	83	79	77	73	69	67	82



Performance certified for Installation type D: Ducted Inlet- Ducted Outlet. Performance ratings do not include the effects of appurtenances (accessories) Power rating kW is fan input power. The Sound Power Level ratings shown are in decibels, referred to 10-12 watts, calculated per AMCA International Standard 301. Values shown are for inlet LWi and LWiA sound power levels for Installation type D: Ducted Inlet-Ducted Outlet. Ratings include the effects of duct end correction. The A-weighted sound ratings shown have been calculated per AMCA International Standard 301.

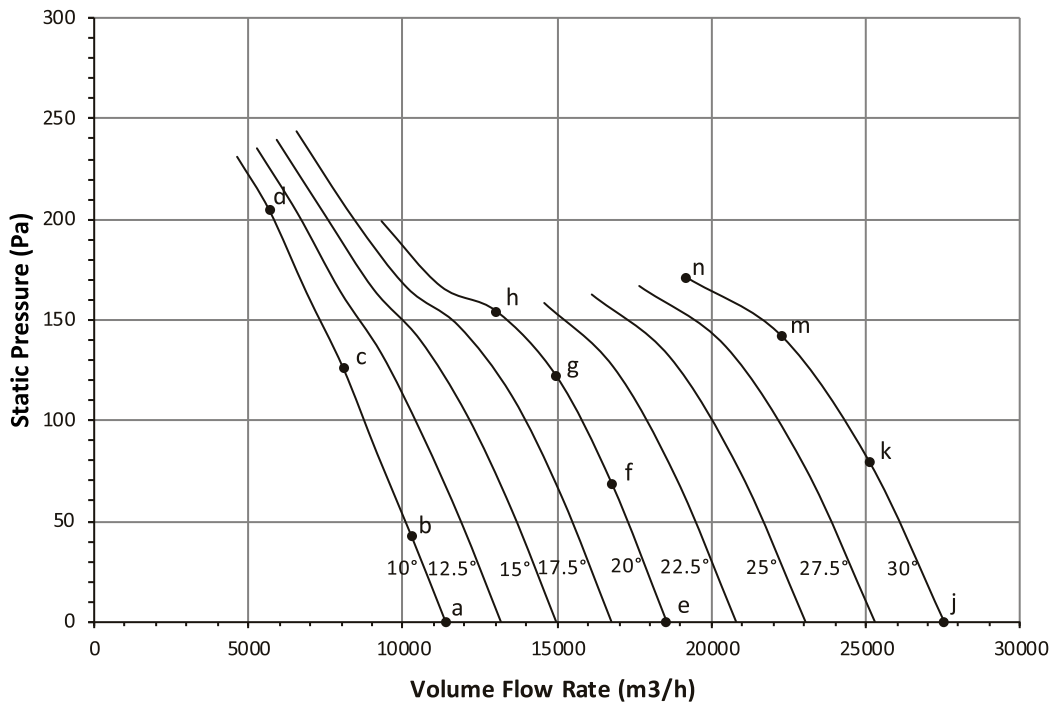
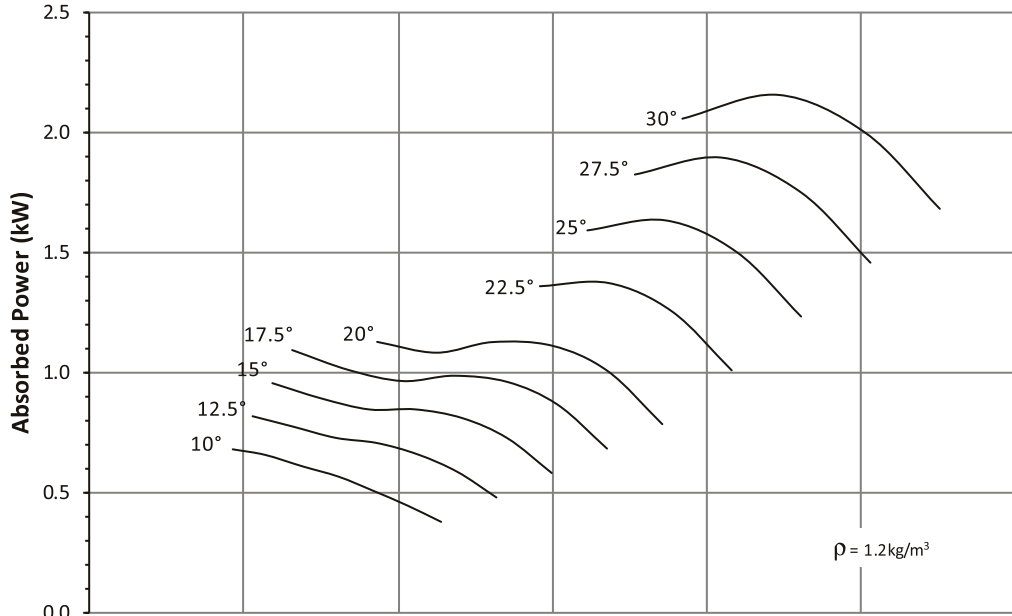

6 Pole - 960 rpm

Ref	Full Octave Band Center Frequency								L _W /A
	63	125	250	500	1K	2K	4K	8K	
a	76	79	81	80	79	80	72	58	85
b	76	78	81	85	84	81	72	58	88
c	83	87	90	87	82	77	67	55	88
d	85	87	90	82	78	73	65	56	85
e	76	80	84	80	80	81	73	57	86
f	77	80	84	81	81	81	73	59	86
g	82	84	87	87	85	81	72	62	89
h	88	92	93	88	85	78	70	62	90
j	79	82	85	82	81	81	73	59	86
k	78	81	84	82	81	79	73	65	86
m	83	85	85	84	83	79	74	68	87
n	93	94	90	89	86	81	74	67	91



Performance certified is for Installation type D: Ducted Inlet- Ducted Outlet. Performance ratings do not include the effects of appurtenances (accessories)
Power rating kW is fan input power.
The Sound Power Level ratings shown are in decibels, referred to 10⁻¹² watts, calculated per AMCA International Standard 301. Values shown are for inlet L_W and L_W/A sound power levels for Installation type D: Ducted Inlet-Ducted Outlet. Ratings include the effects of duct end correction.
The A-weighted sound ratings shown have been calculated per AMCA International Standard 301.

Performance Curve
FEG 75

ADTA 800-250-12-T
ADTA-F 800-250-12-T

50Hz 960 rpm

Outlet Area: 0.503 m²

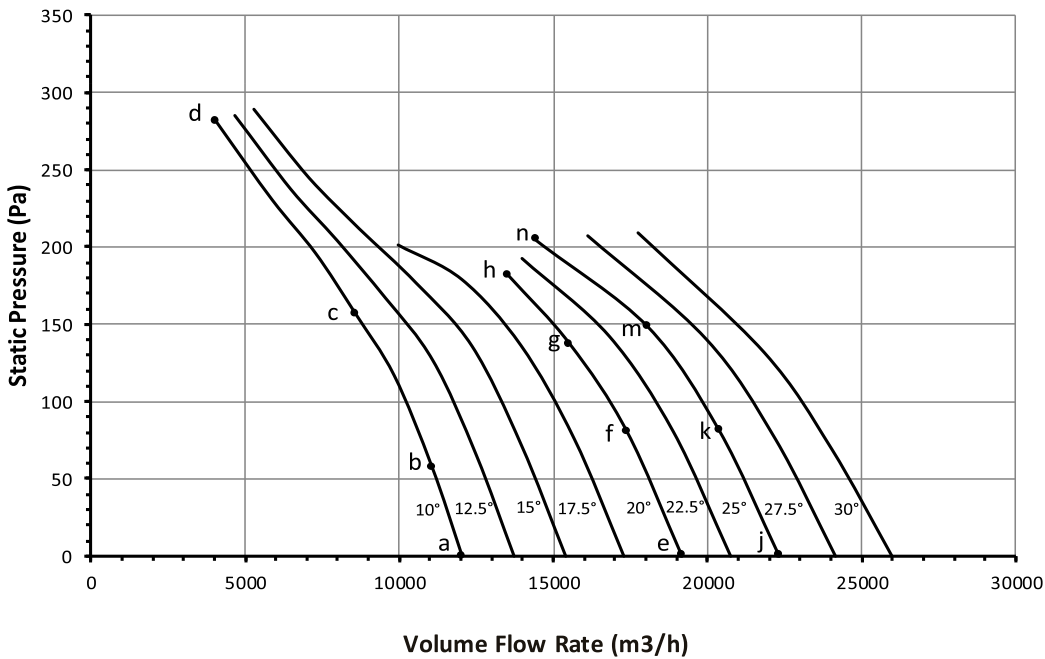
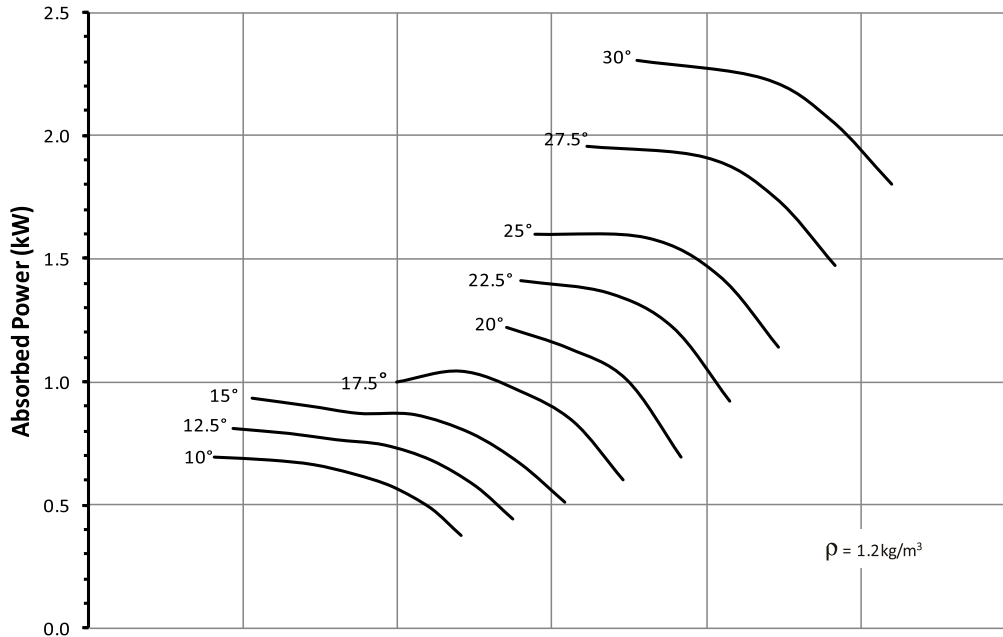

Ref	Full Octave Band Center Frequency								L _W A dB(A)
	63	125	250	500	1K	2K	4K	8K	
a	77	79	82	79	77	78	72	61	83
b	77	79	80	78	79	79	72	63	84
c	78	82	86	86	82	76	69	60	87
d	81	84	88	79	76	72	68	63	83
e	78	83	86	81	78	78	73	64	85
f	77	81	85	81	79	77	73	65	84
g	78	81	86	86	83	80	74	67	88
h	82	86	90	89	84	79	73	67	90
j	80	84	88	82	79	78	82	89	91
k	79	83	87	81	79	76	81	90	91
m	79	82	85	83	80	77	81	89	90
n	89	90	90	89	84	79	78	80	90



Performance certified is for Installation type D: Ducted Inlet- Ducted Outlet. Performance ratings do not include the effects of appurtenances (accessories) Power rating kW is fan input power. The Sound Power Level ratings shown are in decibels, referred to 10-12 watts, calculated per AMCA International Standard 301. Values shown are for inlet LWi and LWiA sound power levels for Installation type D: Ducted Inlet-Ducted Outlet. Ratings include the effects of duct end correction. The A-weighted sound ratings shown have been calculated per AMCA International Standard 301.

6 Pole - 960 rpm

Performance Curve FEG 60

ADTA 900-400-08
ADTA-F 900-400-08

50Hz 960 rpm

Outlet Area: 0.636 m²

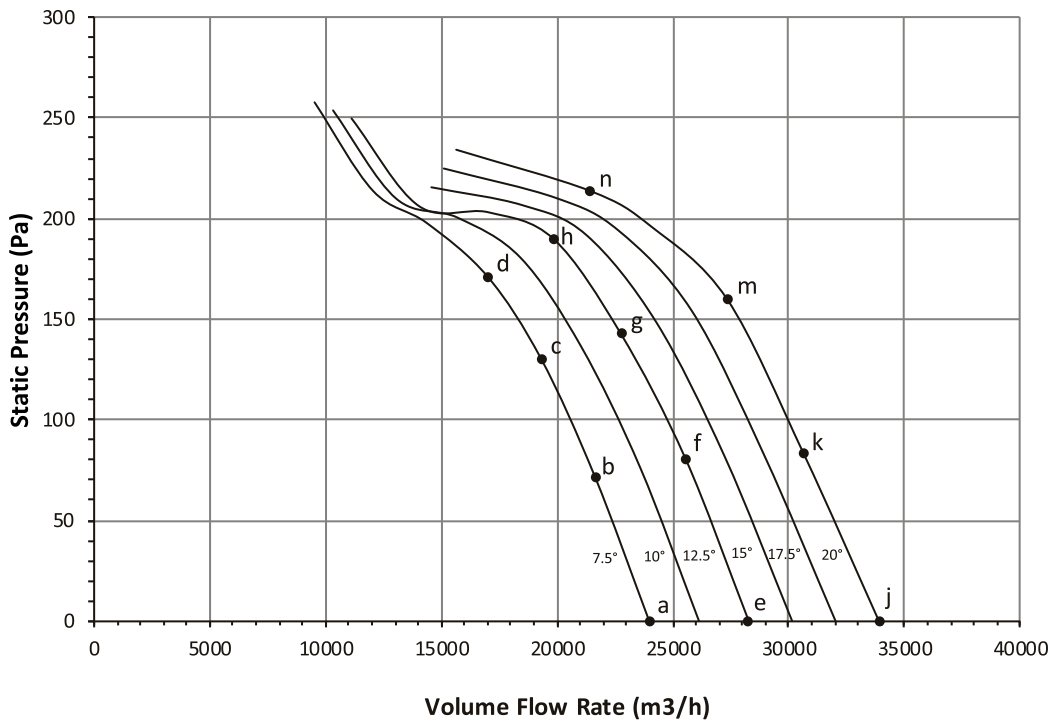
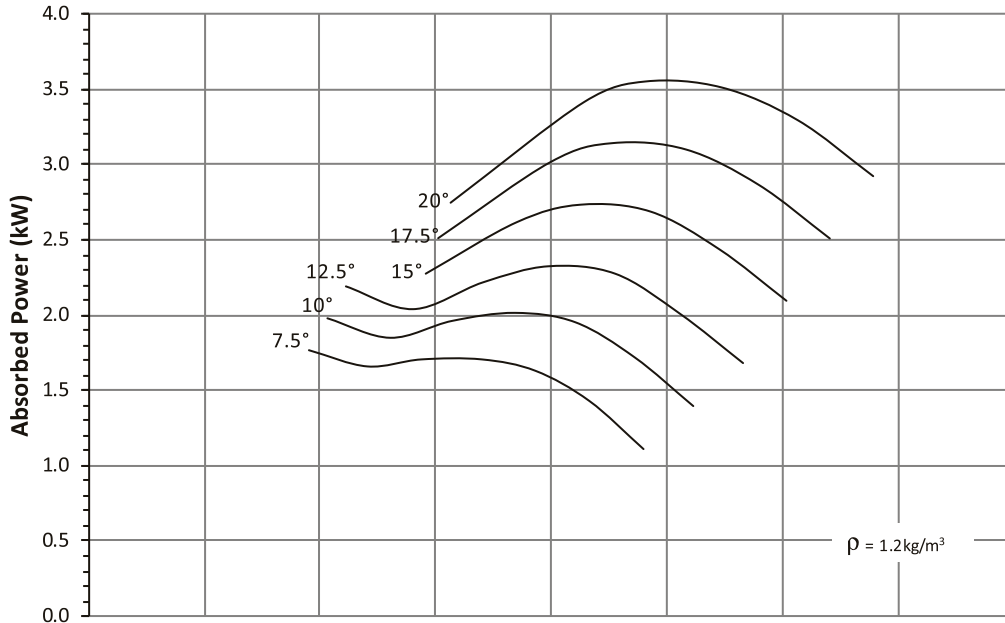

Ref	Full Octave Band Center Frequency								L _{WA} dB(A)
	63	125	250	500	1K	2K	4K	8K	
a	80	84	85	82	78	76	74	70	85
b	78	83	85	83	79	76	73	67	85
c	80	83	87	86	83	80	75	69	88
d	84	87	91	91	87	82	75	68	92
e	80	86	86	83	79	76	73	69	85
f	81	85	85	83	79	77	72	66	85
g	83	86	87	86	83	80	75	69	88
h	85	91	92	90	86	82	76	70	92
j	84	89	88	86	82	78	73	67	88
k	86	89	88	85	82	78	74	69	87
m	86	88	88	85	82	79	76	72	88
n	88	93	92	90	86	82	78	74	92



Performance certified for Installation type D: Ducted Inlet- Ducted Outlet. Performance ratings do not include the effects of appurtenances (accessories)
Power rating kW is fan input power.
The Sound Power Level ratings shown are in decibels, referred to 10⁻¹² watts, calculated per AMCA International Standard 301. Values shown are for inlet L_w and L_{wA} sound power levels for Installation type D: Ducted Inlet-Ducted Outlet. Ratings include the effects of duct end correction.
The A-weighted sound ratings shown have been calculated per AMCA International Standard 301.

6 Pole - 960 rpm

Performance Curve
FEG 75

ADTA 1000-250-06
ADTA-F 1000-250-06

50Hz 960rpm

Outlet Area: 0.785 m²

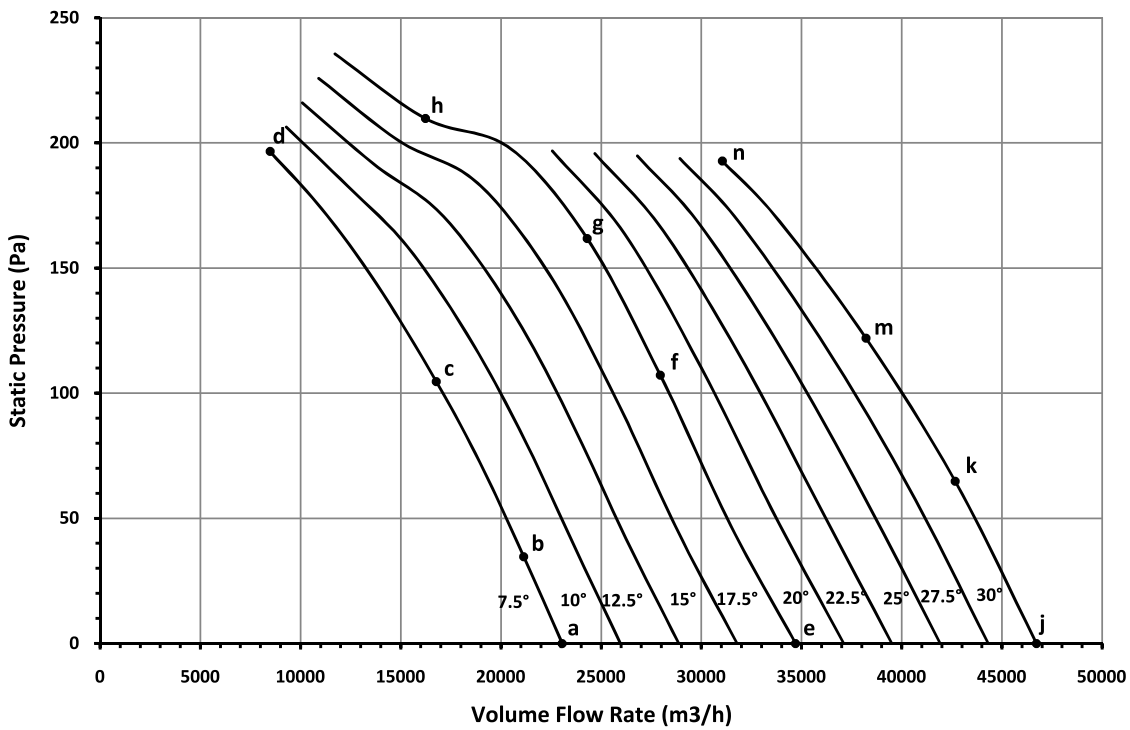
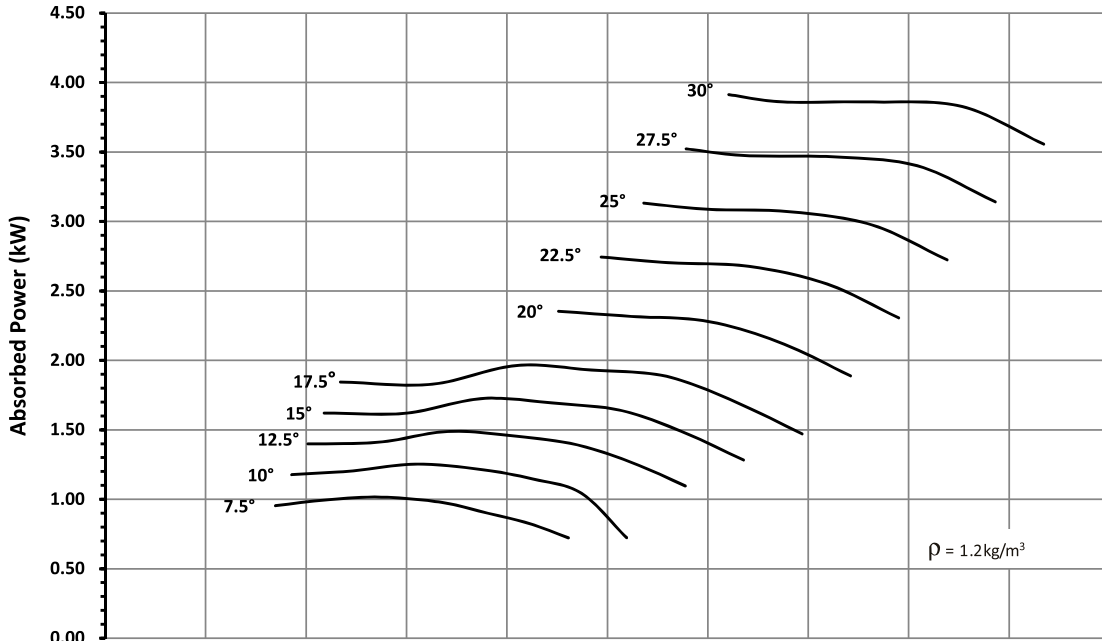

Ref	Full Octave Band Center Frequency								L _{WA} dB(A)
	63	125	250	500	1K	2K	4K	8K	
a	77	83	85	84	82	81	78	73	88
b	77	81	83	85	84	83	79	74	89
c	77	80	87	90	88	83	77	70	92
d	83	94	96	90	84	79	74	68	92
e	84	85	86	84	81	80	78	75	88
f	82	83	85	84	81	79	76	72	87
g	82	84	90	92	88	83	78	73	93
h	84	91	99	98	92	85	79	72	98
j	86	89	90	89	85	82	79	77	91
k	86	88	89	88	85	82	79	77	90
m	86	87	88	88	86	83	80	78	91
n	86	89	91	90	88	84	81	79	93



Performance certified is for Installation type D: Ducted Inlet- Ducted Outlet. Performance ratings do not include the effects of appurtenances (accessories) Power rating kW is fan input power. The Sound Power Level ratings shown are in decibels, referred to 10⁻¹² watts, calculated per AMCA International Standard 301. Values shown are for inlet L_{WA} and L_{WA} sound power levels for Installation type D: Ducted Inlet-Ducted Outlet. Ratings include the effects of duct end correction. The A-weighted sound ratings shown have been calculated per AMCA International Standard 301.

6 Pole - 960 rpm

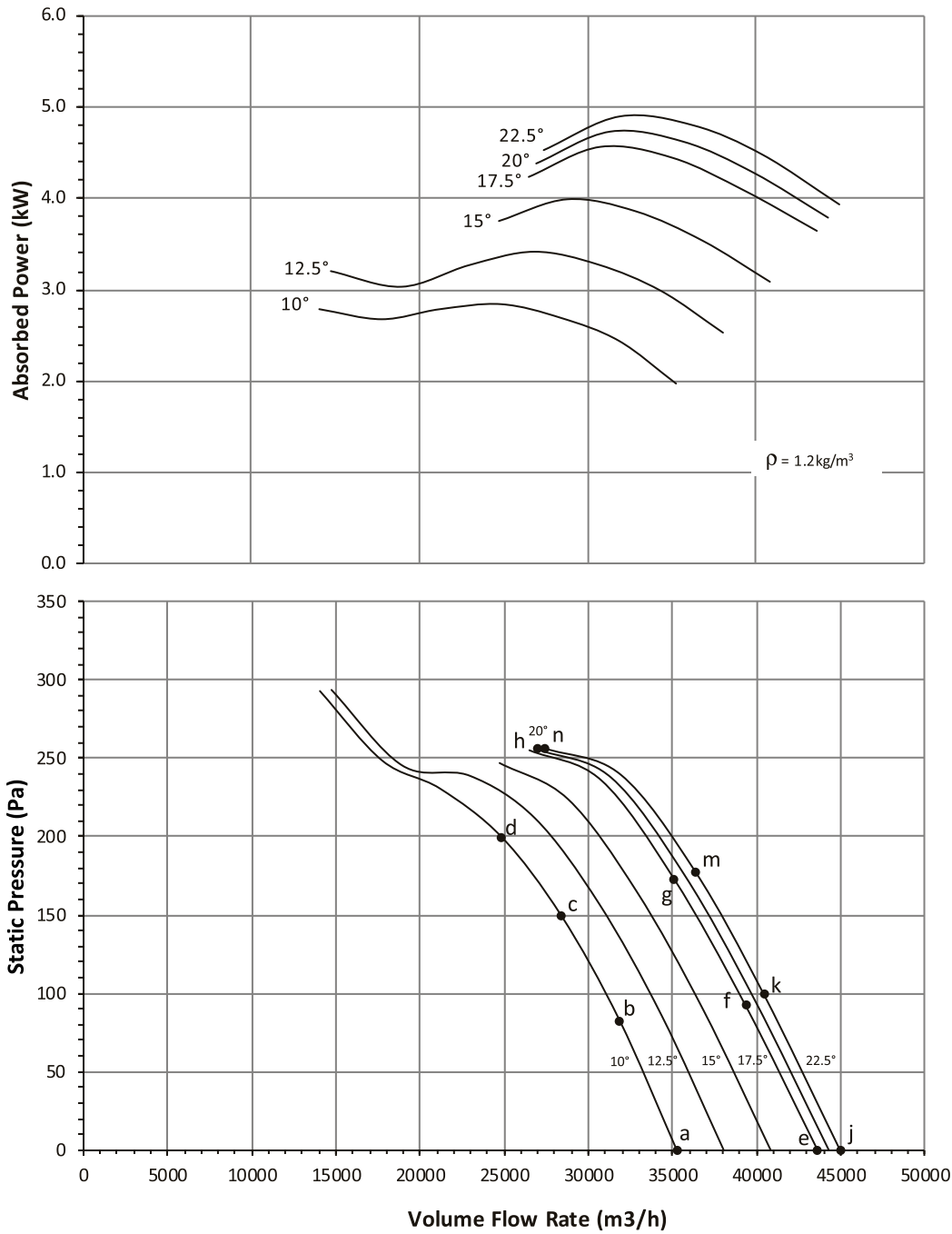

Ref	Full Octave Band Center Frequency								L _w A dB(A)
	63	125	250	500	1K	2K	4K	8K	
a	83	85	87	86	82	80	78	76	88
b	84	85	87	86	83	81	78	74	88
c	85	87	91	91	88	85	80	74	93
d	88	93	97	96	92	86	80	74	97
e	86	88	90	88	84	81	78	73	90
f	86	88	90	87	83	81	78	73	89
g	87	88	90	89	86	84	80	76	91
h	91	97	100	95	91	87	82	77	97
j	86	88	90	88	84	81	78	73	90
k	87	88	90	87	84	82	78	72	90
m	87	88	91	89	87	84	80	76	92
n	91	97	100	94	90	86	82	77	97



Performance certified for Installation type D: Ducted Inlet- Ducted Outlet. Performance ratings do not include the effects of appurtenances (accessories). Power rating kW is fan input power. The Sound Power Level ratings shown are in decibels, referred to 10⁻¹² watts, calculated per AMCA International Standard 301. Values shown are for inlet L_w and L_wA sound power levels for Installation type D: Ducted Inlet-Ducted Outlet. Ratings include the effects of duct end correction. The A-weighted sound ratings shown have been calculated per AMCA International Standard 301.

6 Pole - 960 rpm

Performance Curve
FEG 71

ADTA 1120-400-08
ADTA-F 1120-400-08

50Hz 960rpm
Outlet Area: 0.985 m²

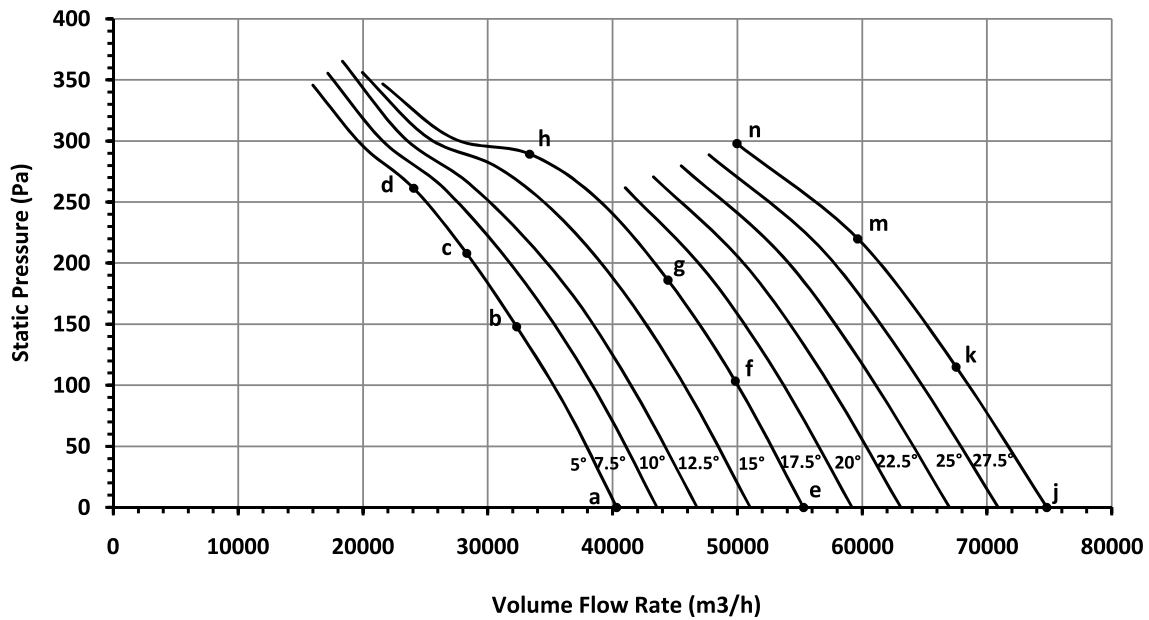
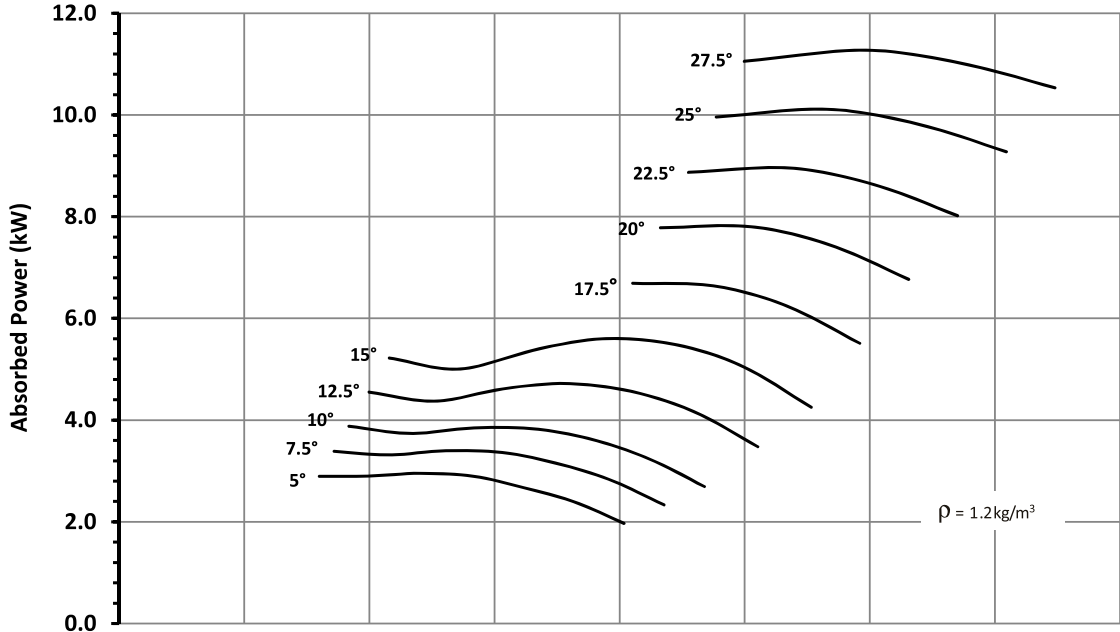

Ref	Full Octave Band Center Frequency							L _w A dB(A)	
	63	125	250	500	1K	2K	4K		8K
a	85	85	88	89	86	83	82	82	92
b	83	87	93	96	95	90	84	77	98
c	86	93	97	97	93	88	82	75	98
d	91	96	99	95	91	86	81	75	97
e	89	90	93	89	86	82	80	78	92
f	88	88	91	88	86	84	81	77	92
g	90	91	93	93	91	89	85	80	96
h	101	103	103	97	93	88	83	77	99
j	101	95	93	93	90	86	84	81	95
k	104	96	93	93	90	87	85	82	96
m	101	96	92	92	91	87	86	83	96
n	99	101	98	97	95	90	86	82	99



Performance certified is for Installation type D: Ducted Inlet- Ducted Outlet. Performance ratings do not include the effects of appurtenances (accessories) Power rating kW is fan input power. The Sound Power Level ratings shown are in decibels, referred to 10⁻¹² watts, calculated per AMCA International Standard 301. Values shown are for outlet L_w and L_wA sound power levels for Installation type D: Ducted Inlet-Ducted Outlet. Ratings include the effects of duct end correction. The A-weighted sound ratings shown have been calculated per AMCA International Standard 301.

6 Pole - 960 rpm

Performance Curve FEG 75

ADTA 1250-400-12
ADTA-F 1250-400-12

50Hz 960rpm

Outlet Area: 1.227 m²

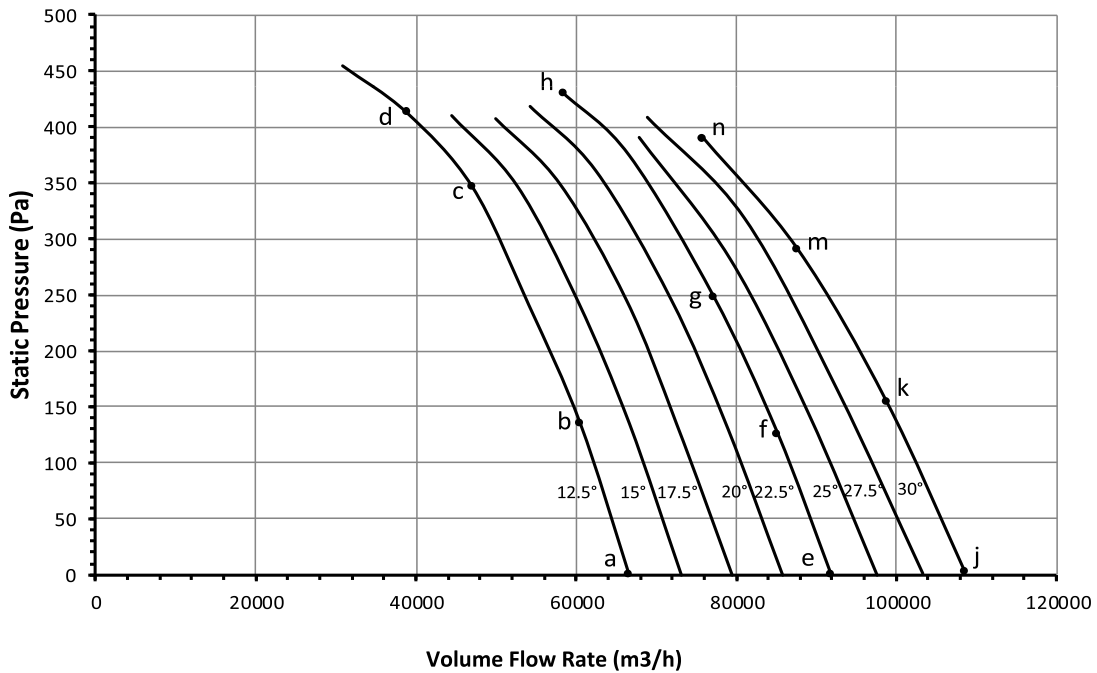
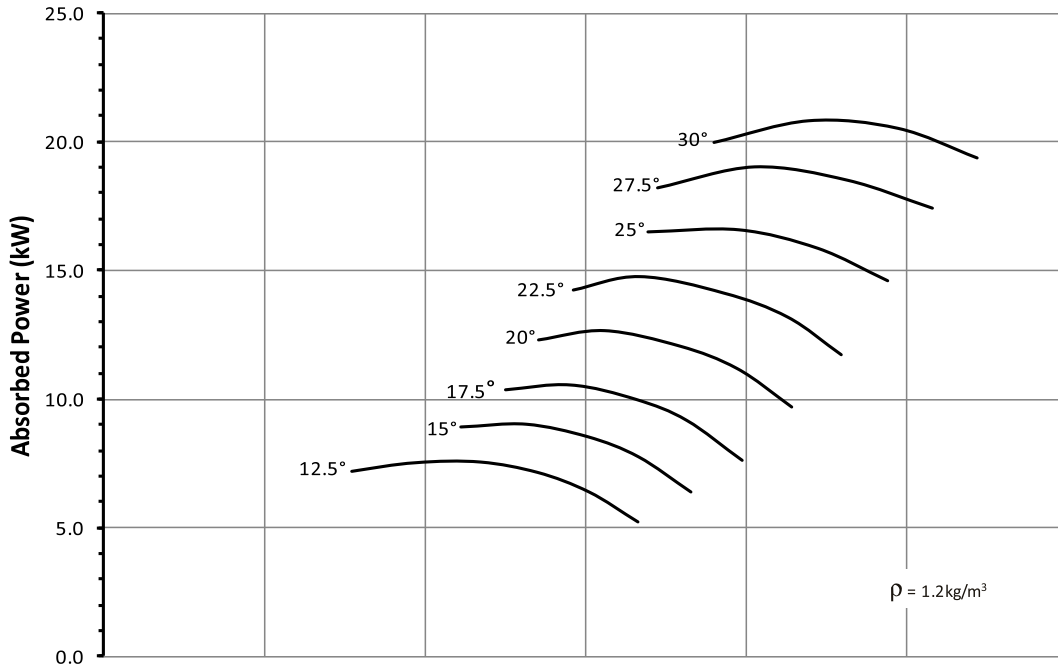

Ref	Full Octave Band Center Frequency							L _w A dB(A)	
	63	125	250	500	1K	2K	4K		8K
a	96	89	96	93	92	90	90	84	98
b	95	89	95	93	94	93	90	83	99
c	92	94	105	101	98	93	88	81	103
d	97	101	108	100	97	92	87	81	103
e	102	93	98	94	93	89	88	85	98
f	103	94	97	94	93	90	87	85	98
g	99	92	97	95	95	92	88	85	99
h	98	106	104	103	100	95	90	85	105
j	104	96	98	96	94	91	88	86	99
k	105	96	98	97	95	92	89	87	100
m	101	95	99	98	97	94	91	88	102
n	101	111	104	104	102	97	92	87	106



Performance certified is for Installation type D: Ducted Inlet- Ducted Outlet. Performance ratings do not include the effects of appurtenances (accessories) Power rating kW is fan input power. The Sound Power Level ratings shown are in decibels, referred to 10-12 watts, calculated per AMCA International Standard 301. Values shown are for outlet L_w and L_wA sound power levels for Installation type D: Ducted Inlet-Ducted Outlet. Ratings include the effects of duct end correction. The A-weighted sound ratings shown have been calculated per AMCA International Standard 301.

6 Pole - 960 rpm

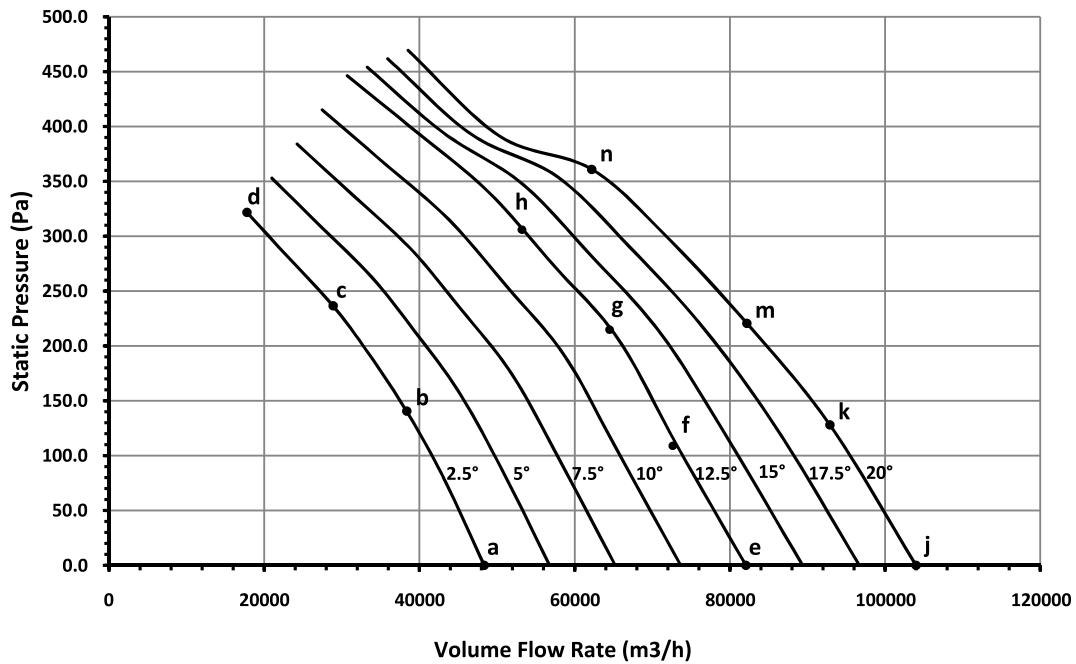
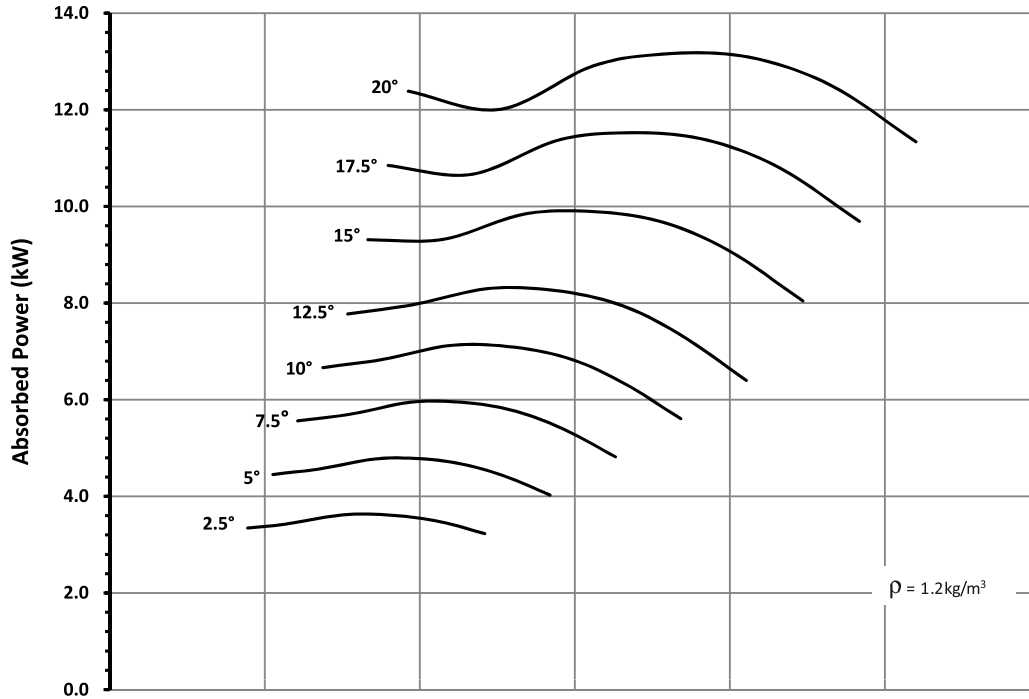

6 Pole - 960 rpm

Ref	Full Octave Band Center Frequency								L _{w0A} db(A)
	63	125	250	500	1k	2k	4k	8k	
a	89	91	95	98	96	93	90	82	101
b	89	96	99	99	96	92	88	80	101
c	92	100	99	96	93	90	85	79	98
d	95	96	94	91	90	87	84	79	95
e	92	92	92	95	98	97	93	85	103
f	92	92	94	96	98	97	92	85	103
g	92	95	98	100	100	96	91	85	103
h	92	103	103	101	98	94	90	85	103
j	95	98	96	96	98	97	92	86	103
k	93	97	98	99	100	97	92	87	104
m	94	98	101	103	101	97	93	87	106
n	107	106	103	100	98	95	91	86	103



Performance certified is for Installation type A: Free Inlet-Free Outlet. Performance ratings do not include the effects of appurtenances (accessories)
Power rating kW is fan input power.
The Sound Power Level ratings shown are in decibels, referred to 10⁻¹² watts, calculated per AMCA International Standard 301. Values shown are for outlet L_{w0} and L_{w0A} sound power levels for Installation type A: Free Inlet - Free Outlet. The A-weighted sound ratings shown have been calculated per AMCA International Standard 301.

Performance Curve
FEG 60

ADTA 1400-400-12
ADTA-F 1400-400-12

50Hz 960 rpm

Outlet Area: 1.550 m²

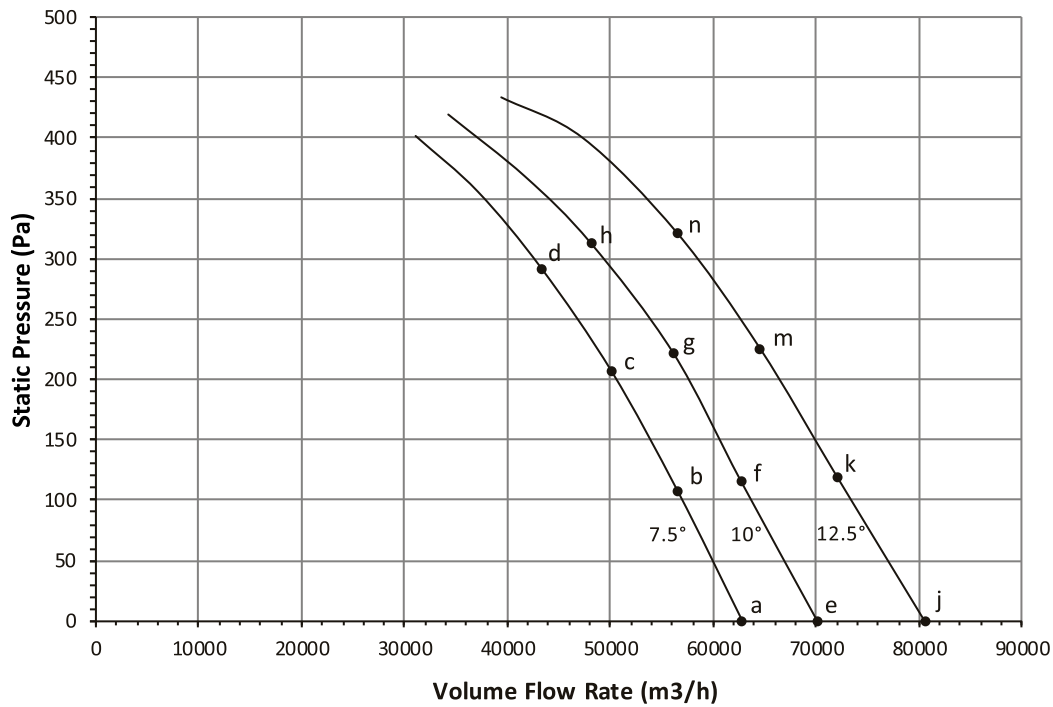

Ref	Full Octave Band Center Frequency								L _w A dB(A)
	63	125	250	500	1K	2K	4K	8K	
a	87	92	96	99	100	96	93	85	103
b	88	94	99	101	100	96	91	83	104
c	91	97	102	102	100	95	90	82	104
d	92	99	103	101	98	94	89	80	103
e	90	93	96	99	100	97	93	86	104
f	92	96	99	102	101	97	92	84	105
g	92	99	103	103	101	96	91	82	105
h	93	99	103	102	99	95	90	81	104
j	90	93	95	98	100	99	95	87	105
k	91	96	99	102	102	98	92	84	105
m	93	100	105	104	102	97	91	83	106
n	95	101	105	103	100	96	91	82	105



Performance certified is for Installation type A: Free Inlet - Free Outlet. Performance ratings do not include the effects of appurtenances (accessories). Power rating kW is fan input power. The Sound Power Level ratings shown are in decibels, referred to 10⁻¹² watts, calculated per AMCA International Standard 301. Values shown are for outlet L_{w0} and L_wA sound power levels for Installation type A: Free Inlet - Free Outlet. The A-weighted sound ratings shown have been calculated per AMCA International Standard 301.

6 Pole - 960 rpm

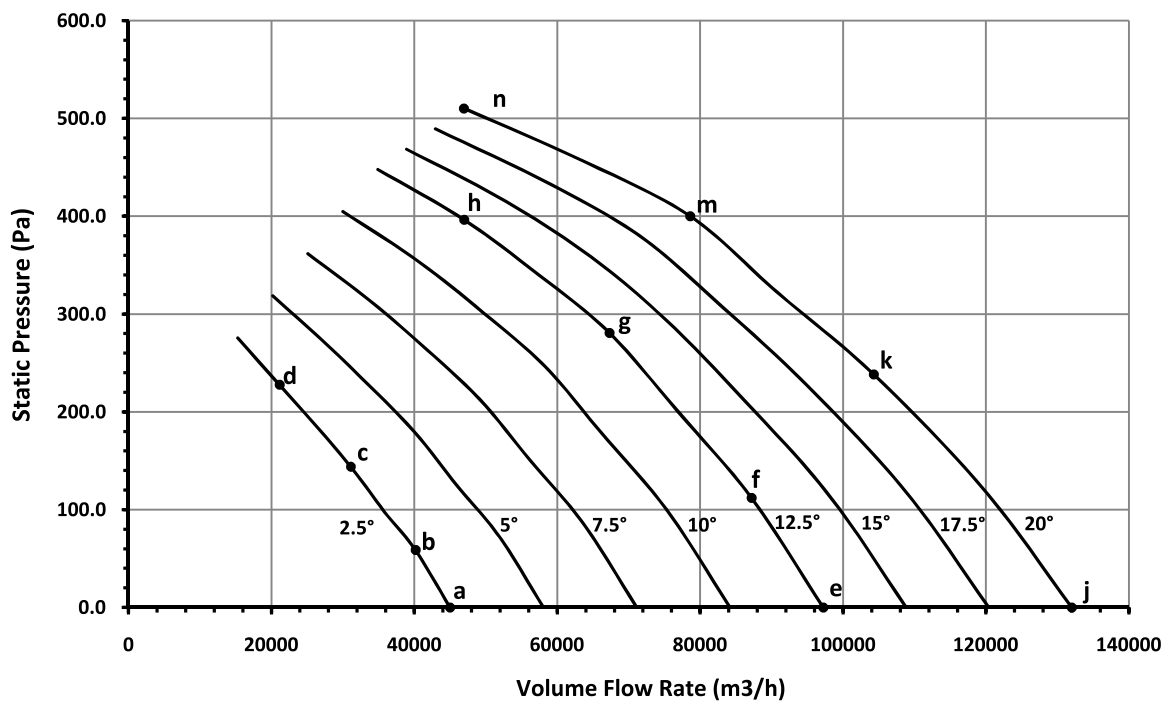
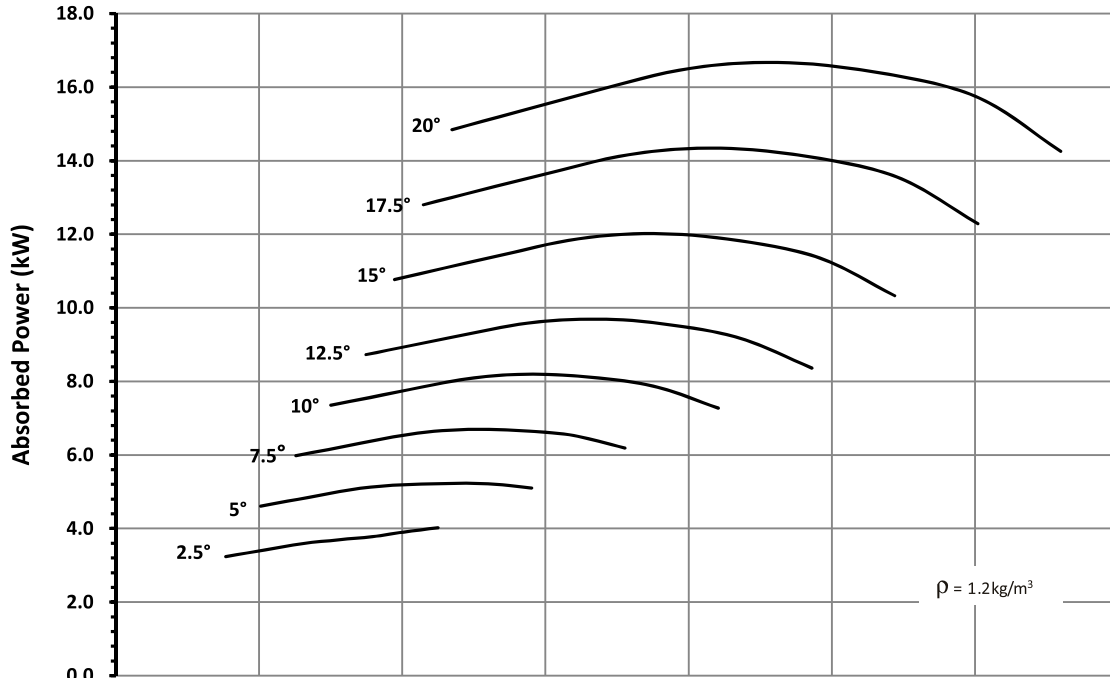

6 Pole - 960 rpm

Ref	Full Octave Band Center Frequency							L _w A	
	63	125	250	500	1k	2k	4k		8k
a	96	100	101	101	99	95	91	84	104
b	95	99	100	100	99	95	91	84	103
c	94	96	96	96	96	94	91	84	101
d	95	96	96	95	95	93	91	87	100
e	94	96	99	101	102	99	96	88	106
f	93	98	101	103	102	98	94	86	106
g	91	99	102	103	100	95	91	85	105
h	95	102	102	99	96	93	89	85	102
j	97	97	98	101	103	100	96	90	107
k	97	99	103	105	103	99	94	88	108
m	95	102	104	105	102	98	94	89	107
n	101	102	102	100	98	96	93	89	103



Performance certified for Installation type A: Free Inlet-Free Outlet. Performance ratings do not include the effects of appurtenances (accessories)
Power rating kW is fan input power.
The Sound Power Level ratings shown are in decibels, referred to 10⁻¹² watts, calculated per AMCA International Standard 301. Values shown are for outlet L_w and L_wA sound power levels for Installation type A: Free Inlet - Free Outlet.
The A-weighted sound ratings shown have been calculated per AMCA International Standard 301.

Performance Curve FEG 56

ADTA 1600-400-16
ADTA-F 1600-400-16

50Hz 960 rpm

Outlet Area: 2.023 m²

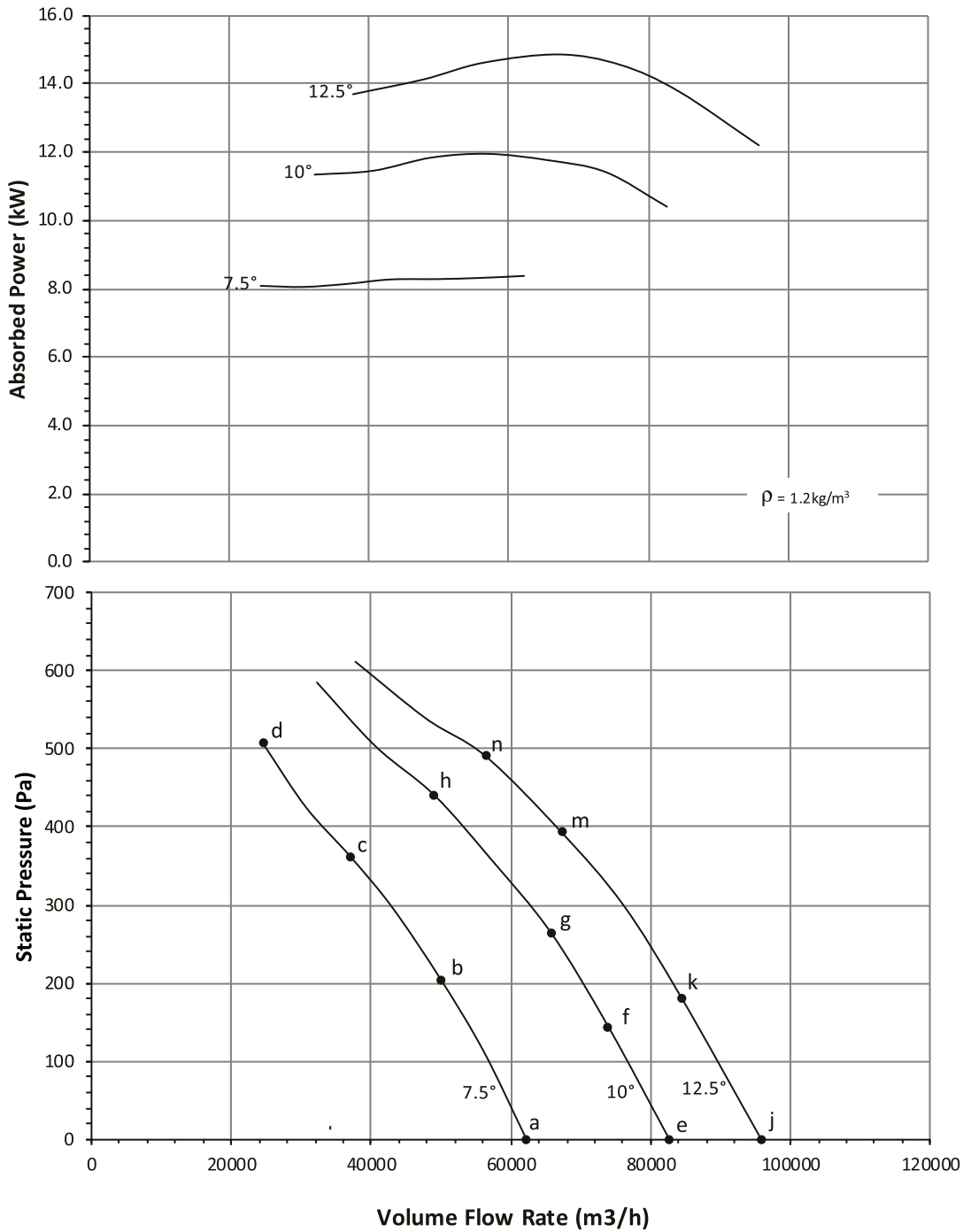

Ref	Full Octave Band Center Frequency								L _w A dB(A)
	63	125	250	500	1K	2K	4K	8K	
a	93	98	105	103	102	99	96	91	107
b	93	104	107	102	101	98	94	87	106
c	92	101	104	100	99	96	91	86	104
d	90	96	100	98	97	95	91	87	102
e	92	95	106	106	103	100	97	90	108
f	91	98	107	105	103	100	96	89	108
g	92	101	107	104	103	99	95	87	107
h	93	104	108	102	101	98	92	84	106
j	94	96	105	106	104	100	98	91	109
k	94	98	108	107	104	100	96	88	109
m	93	103	108	105	103	99	94	86	108
n	94	105	108	103	102	98	93	86	107



Performance certified is for Installation type A: Free Inlet-Free Outlet. Performance ratings do not include the effects of appurtenances (accessories)
Power rating kW is fan input power.
The Sound Power Level ratings shown are in decibels, referred to 10⁻¹² watts, calculated per AMCA International Standard 301. Values shown are for outlet L_{wc} and L_wA sound power levels for Installation type A: Free Inlet - Free Outlet. The A-weighted sound ratings shown have been calculated per AMCA International Standard 301.

6 Pole - 960 rpm

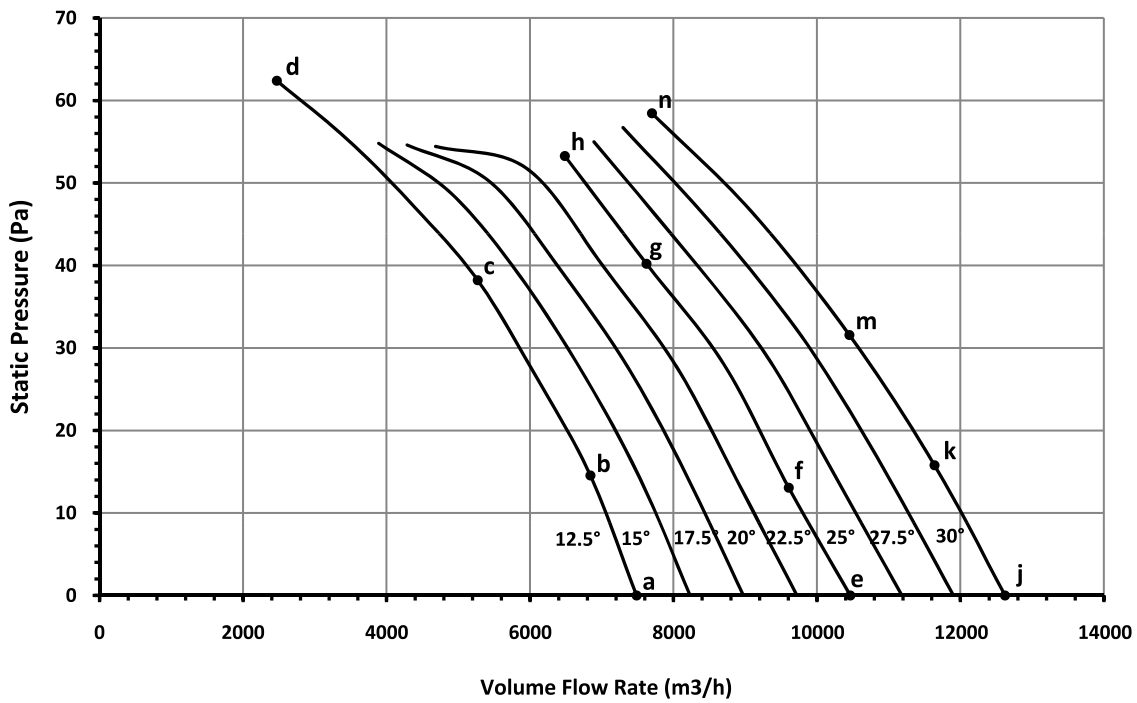
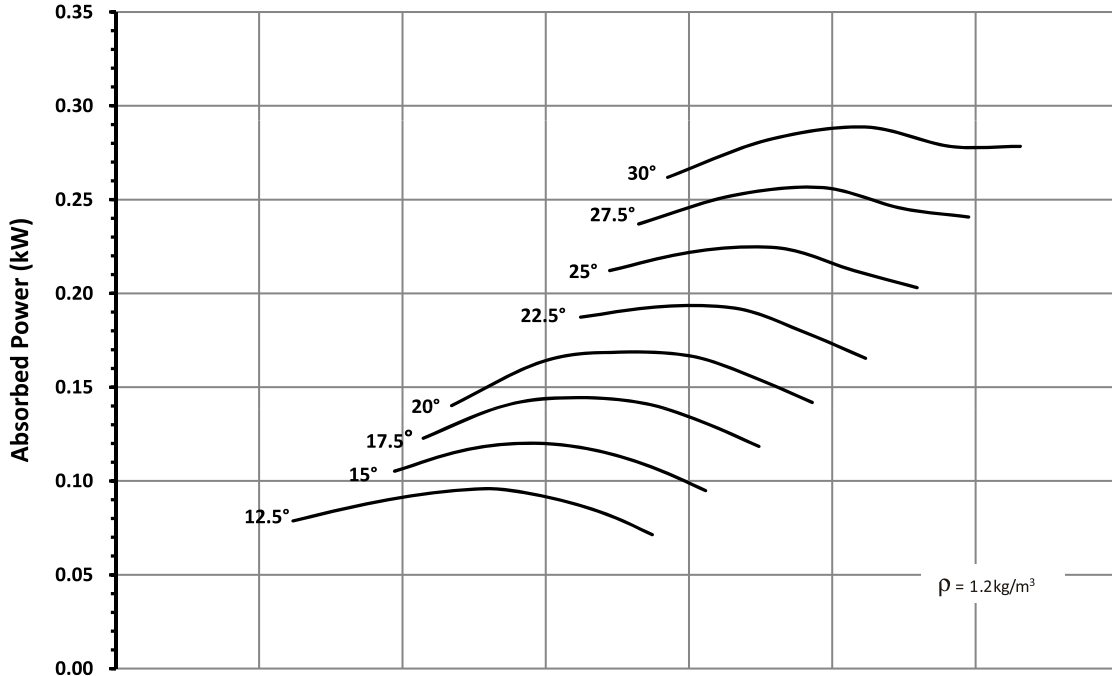

Ref	Full Octave Band Center Frequency								L _W /A dB(A)
	63	125	250	500	1K	2K	4K	8K	
a	63	62	65	65	63	64	62	60	70
b	62	61	64	64	62	62	61	60	69
c	63	65	72	74	71	65	61	57	75
d	67	73	82	75	71	65	59	54	78
e	70	73	69	68	65	64	62	60	72
f	70	66	68	67	66	64	61	58	71
g	69	66	68	68	67	65	61	57	72
h	69	66	69	70	69	65	61	57	73
j	72	70	71	71	69	66	63	60	73
k	71	70	70	70	69	66	62	58	73
m	72	69	69	70	69	66	62	58	73
n	72	71	71	72	70	66	63	60	74



Performance certified is for Installation type D: Ducted Inlet- Ducted Outlet. Performance ratings do not include the effects of appurtenances (accessories). Power rating kW is fan input power. The Sound Power Level ratings shown are in decibels, referred to 10⁻¹² watts, calculated per AMCA International Standard 301. Values shown are for inlet L_W and L_W/A sound power levels for Installation type D: Ducted Inlet-Ducted Outlet. Ratings include the effects of duct end correction. The A-weighted sound ratings shown have been calculated per AMCA International Standard 301.

Performance Curve
FEG 60

ADTA 710-230-12
ADTA-F 710-230-12

50Hz 720 rpm

Outlet Area: 0.396 m²

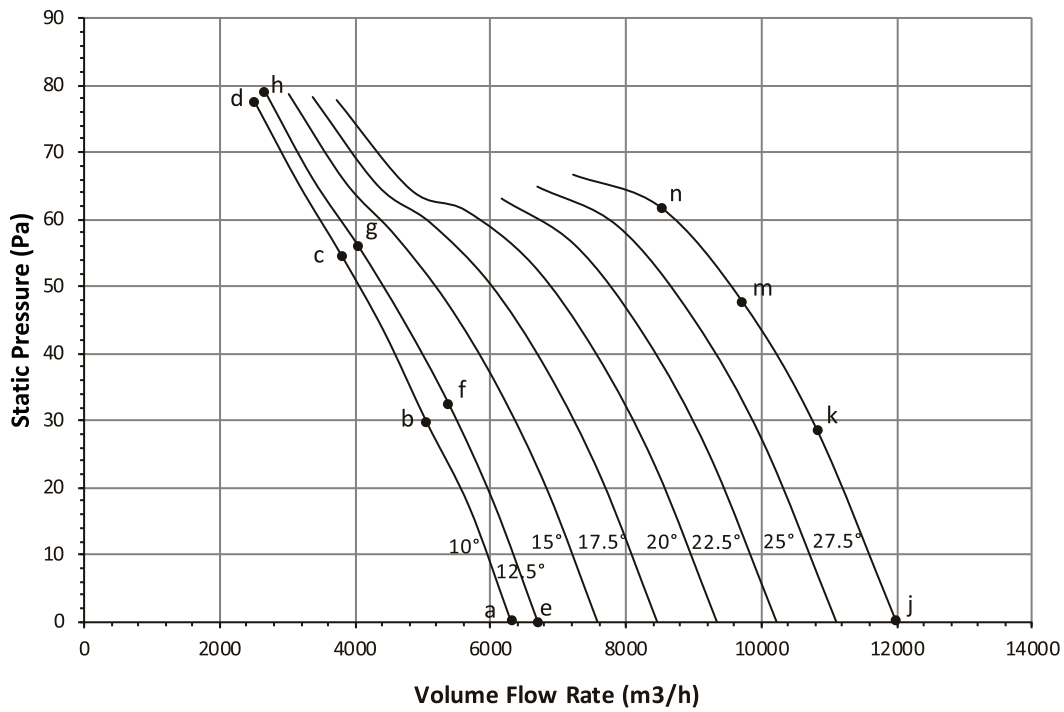
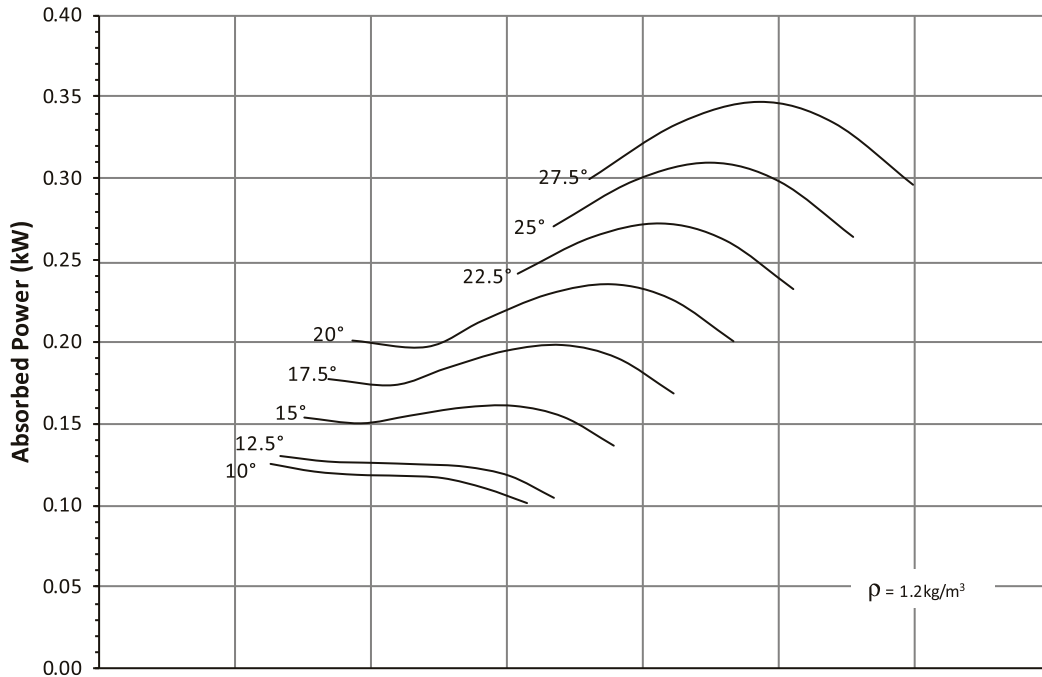

Ref	Full Octave Band Center Frequency								L _w /A dB(A)
	63	125	250	500	1K	2K	4K	8K	
a	66	68	70	72	71	68	64	60	76
b	66	69	77	77	73	68	62	56	78
c	71	80	77	75	71	65	58	51	76
d	70	75	70	68	66	63	56	51	71
e	66	68	70	71	70	69	64	59	75
f	66	70	77	76	73	68	62	56	78
g	71	81	77	75	71	65	58	51	76
h	71	75	70	68	66	62	56	51	71
j	65	75	75	71	68	68	65	62	75
k	66	76	76	71	69	68	65	62	76
m	70	76	80	75	72	69	65	60	78
n	77	81	82	79	75	70	63	56	80



Performance certified for Installation type D: Ducted Inlet- Ducted Outlet. Performance ratings do not include the effects of appurtenances (accessories). Power rating kW is fan input power. The Sound Power Level ratings shown are in decibels, referred to 10⁻¹² watts, calculated per AMCA International Standard 301. Values shown are for inlet L_w and L_w/A sound power levels for Installation type D: Ducted Inlet-Ducted Outlet. Ratings include the effects of duct end correction. The A-weighted sound ratings shown have been calculated per AMCA International Standard 301.

Performance Curve FEG 71

ADTA 710-250-12
ADTA-F 710-250-12

50Hz 720 rpm

Outlet Area: 0.396 m²

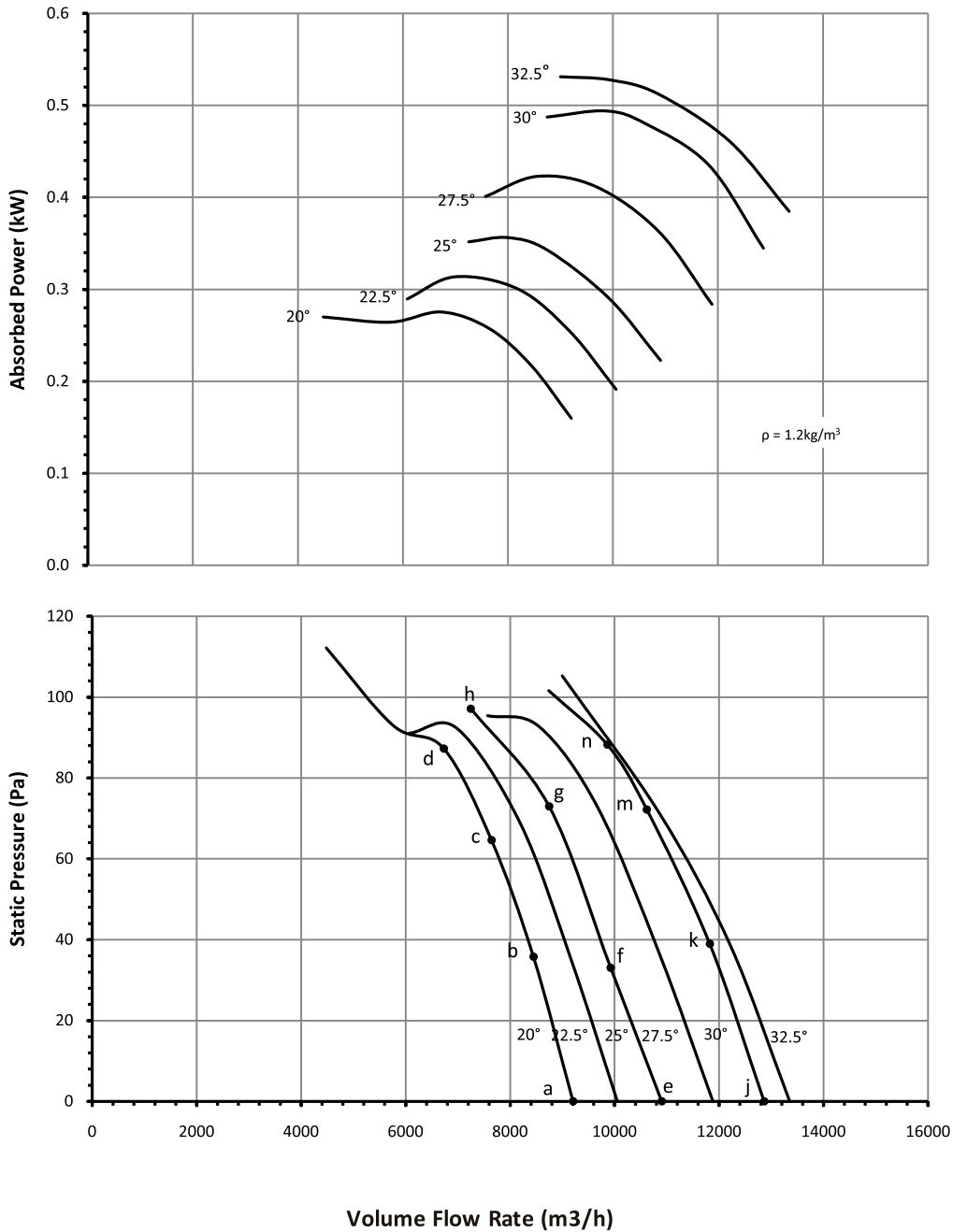

Volume Flow Rate (m3/h)

Ref	Full Octave Band Center Frequency							L _w A dB(A)	
	63	125	250	500	1K	2K	4K		8K
a	65	71	70	69	67	67	58	49	73
b	64	70	69	68	67	66	58	51	72
c	65	70	72	70	69	65	58	52	73
d	70	74	81	76	72	66	59	52	78
e	67	71	71	70	68	67	60	53	74
f	67	71	70	69	68	66	61	56	73
g	67	71	72	70	68	64	62	61	73
h	78	80	81	76	72	66	63	59	80
j	69	72	73	72	69	68	70	72	77
k	68	73	72	70	68	65	65	65	74
m	67	74	71	70	68	63	61	59	73
n	73	77	74	72	69	64	62	59	74



Performance certified is for Installation type D: Ducted Inlet- Ducted Outlet. Performance ratings do not include the effects of appurtenances (accessories) Power rating kW is fan input power. The Sound Power Level ratings shown are in decibels, referred to 10-12 watts, calculated per AMCA International Standard 301. Values shown are for inlet LWi and LWiA sound power levels for Installation type D: Ducted Inlet-Ducted Outlet. Ratings include the effects of duct end correction. The A-weighted sound ratings shown have been calculated per AMCA International Standard 301.

Performance Curve
FEG 71

ADTA 800-250-12
ADTA-F 800-250-12

50Hz 720 rpm
Outlet Area: 0.503 m²

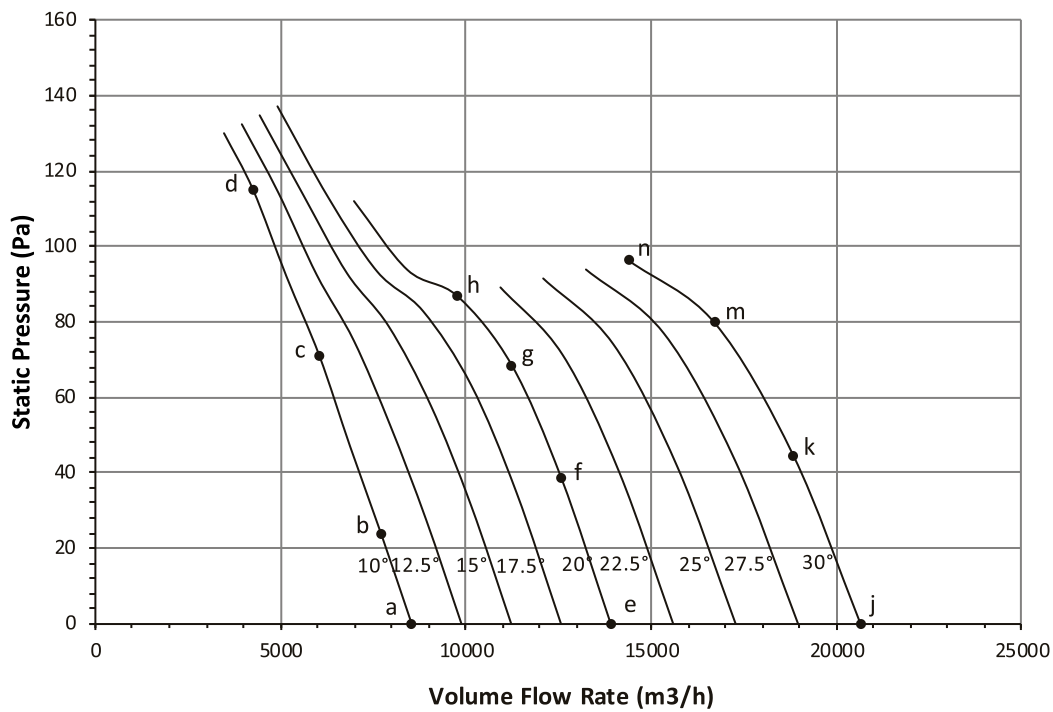
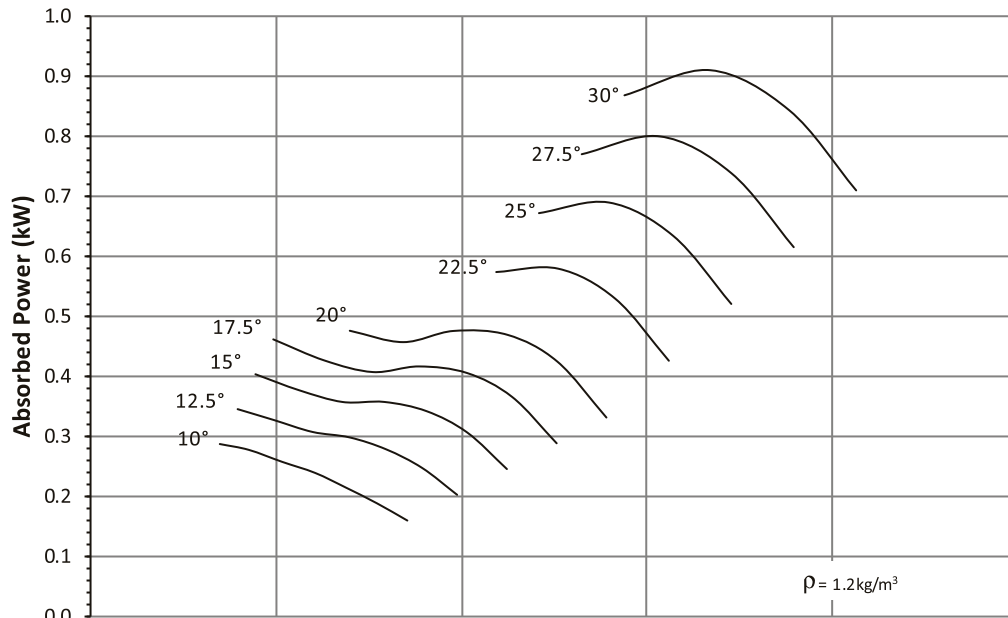

Ref	Full Octave Band Center Frequency							L _w A dB(A)	
	63	125	250	500	1K	2K	4K		8K
a	68	75	75	74	72	74	60	46	78
b	68	75	75	80	76	73	60	46	81
c	76	83	83	79	74	68	56	43	80
d	78	83	83	75	70	64	55	46	78
e	68	77	77	73	73	76	60	44	80
f	69	77	78	75	75	75	61	47	80
g	75	80	82	81	77	72	62	51	82
h	84	86	87	81	76	68	60	52	83
j	71	79	79	76	74	75	61	47	80
k	71	78	78	76	74	71	63	55	79
m	77	79	79	78	75	71	65	59	80
n	93	84	84	82	78	72	65	58	83



Performance certified is for Installation type D: Ducted Inlet- Ducted Outlet. Performance ratings do not include the effects of appurtenances (accessories) Power rating kW is fan input power. The Sound Power Level ratings shown are in decibels, referred to 10⁻¹² watts, calculated per AMCA International Standard 301. Values shown are for inlet L_w and L_wA sound power levels for Installation type D: Ducted Inlet-Ducted Outlet. Ratings include the effects of duct end correction. The A-weighted sound ratings shown have been calculated per AMCA International Standard 301.

Performance Curve FEG 75

ADTA 800-250-12-T
ADTA-F 800-250-12-T

50Hz 720 rpm

Outlet Area: 0.503 m²

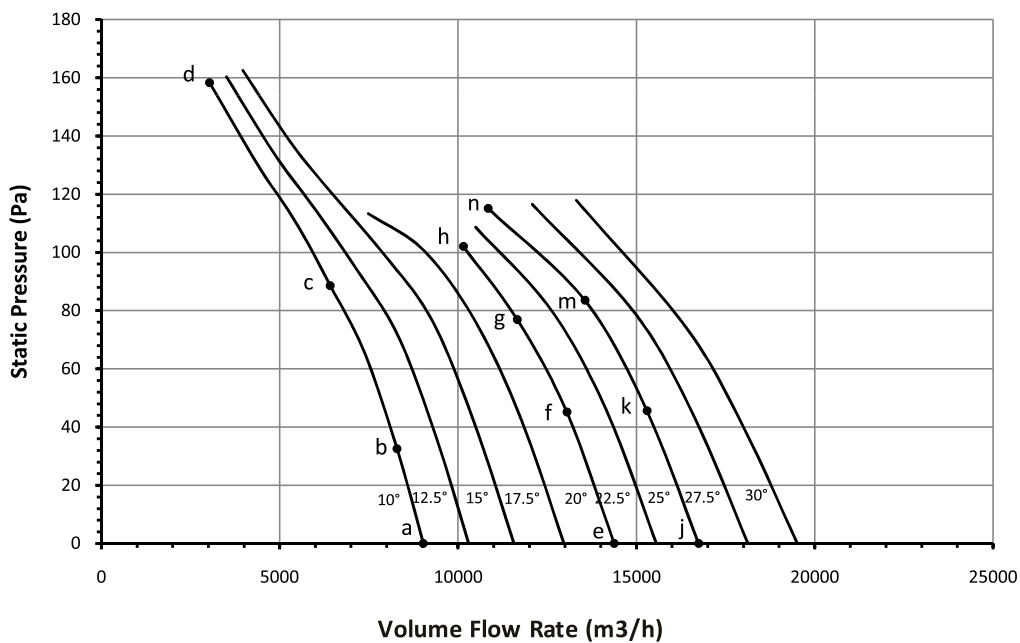
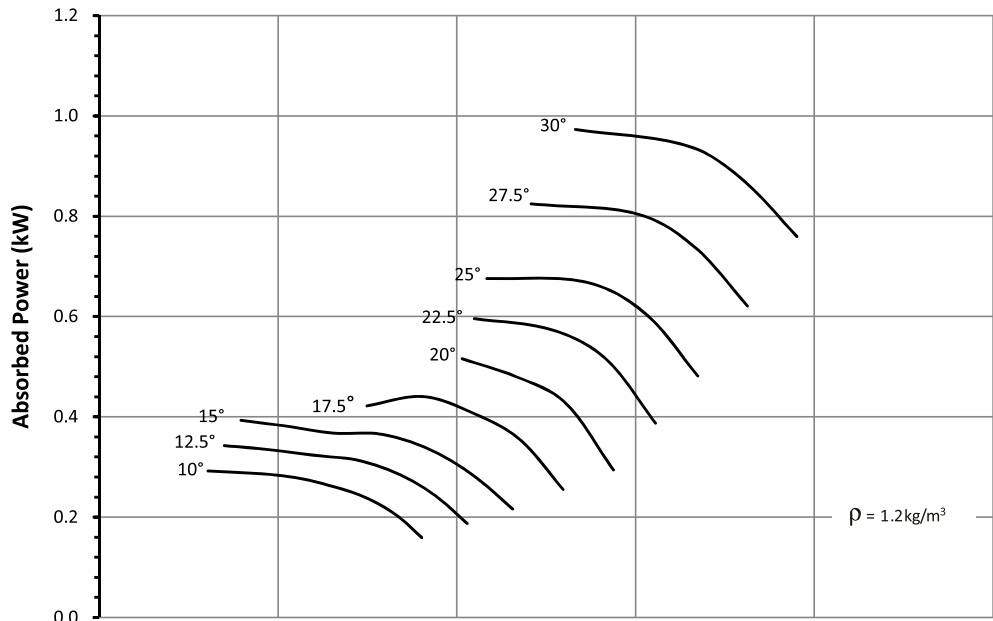

Ref	Full Octave Band Center Frequency							L _{WA} dB(A)	
	63	125	250	500	1K	2K	4K		8K
a	70	75	75	72	70	71	61	51	76
b	69	74	74	72	73	72	62	53	77
c	71	79	79	80	74	68	59	51	80
d	73	81	81	72	74	68	59	56	78
e	71	80	80	74	71	71	63	54	78
f	70	78	78	74	71	71	63	55	77
g	71	78	80	79	76	72	65	55	81
h	76	82	84	81	76	70	64	59	82
j	72	81	82	75	72	71	79	86	87
k	72	80	81	74	71	70	79	87	87
m	72	79	79	76	73	70	78	86	87
n	85	83	85	81	76	70	72	74	83



Performance certified is for Installation type D: Ducted Inlet- Ducted Outlet. Performance ratings do not include the effects of appurtenances (accessories) Power rating kW is fan input power. The Sound Power Level ratings shown are in decibels, referred to 10-12 watts, calculated per AMCA International Standard 301. Values shown are for inlet LWi and LWiA sound power levels for Installation type D: Ducted Inlet-Ducted Outlet. Ratings include the effects of duct end correction. The A-weighted sound ratings shown have been calculated per AMCA International Standard 301.

Performance Curve
FEG 60

ADTA 900-400-08
ADTA-F 900-400-08

50Hz 720 rpm

Outlet Area: 0.636 m²

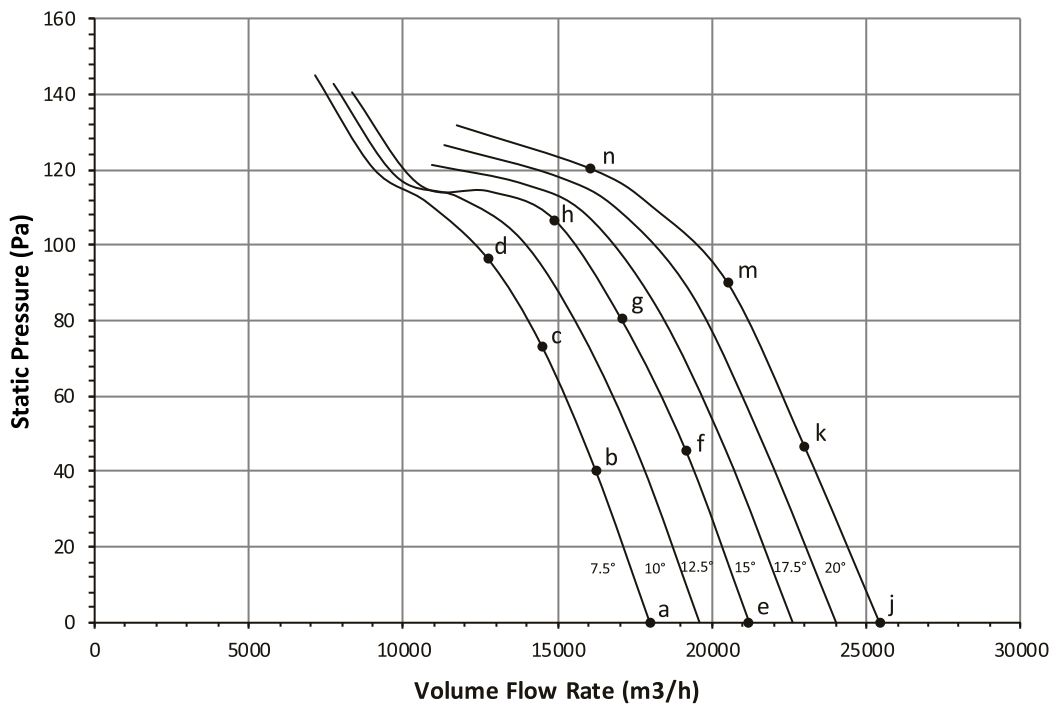
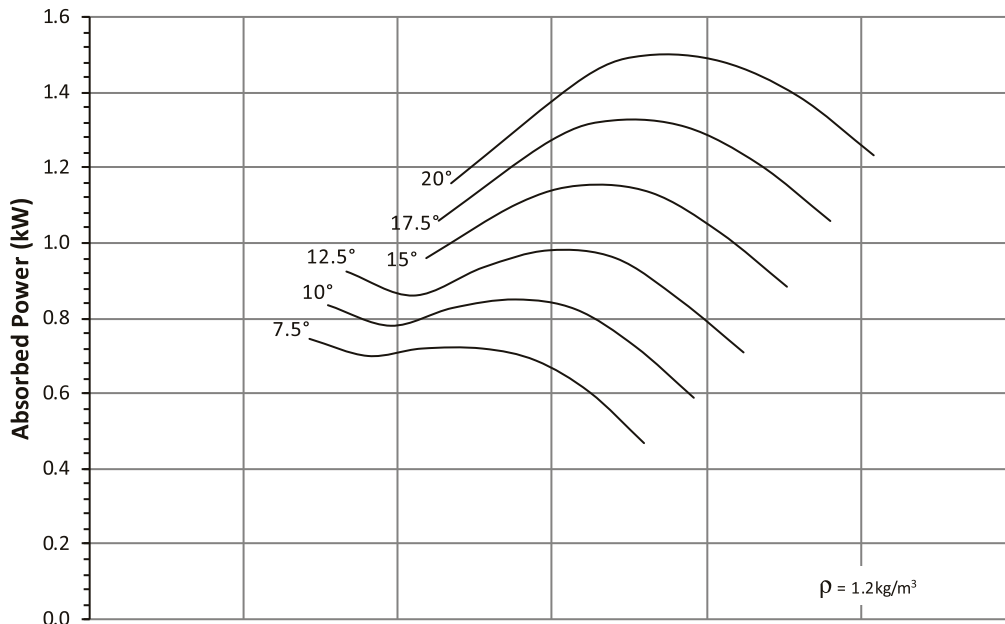

Ref	Full Octave Band Center Frequency								L _{WA} dB(A)
	63	125	250	500	1K	2K	4K	8K	
a	73	78	78	74	70	70	66	62	77
b	73	76	80	74	71	69	64	59	78
c	74	77	82	78	75	72	66	60	81
d	79	82	86	83	79	73	66	59	84
e	74	79	80	75	71	69	65	61	78
f	75	78	79	75	72	69	63	57	78
g	77	79	81	78	75	72	66	60	81
h	80	85	86	82	78	73	67	61	84
j	78	83	83	79	74	71	65	59	80
k	80	83	83	78	74	71	66	61	80
m	80	82	82	78	75	72	68	64	81
n	84	86	86	82	78	75	71	67	84



Performance certified for Installation type D: Ducted Inlet- Ducted Outlet. Performance ratings do not include the effects of appurtenances (accessories)
Power rating kW is fan input power.
The Sound Power Level ratings shown are in decibels, referred to 10⁻¹² watts, calculated per AMCA International Standard 301. Values shown are for inlet L_{WA} and L_{WA} sound power levels for Installation type D: Ducted Inlet-Ducted Outlet. Ratings include the effects of duct end correction.
The A-weighted sound ratings shown have been calculated per AMCA International Standard 301.

Performance Curve FEG 75

ADTA 1000-250-06
ADTA-F 1000-250-06

50Hz 720rpm
Outlet Area: 0.785 m²

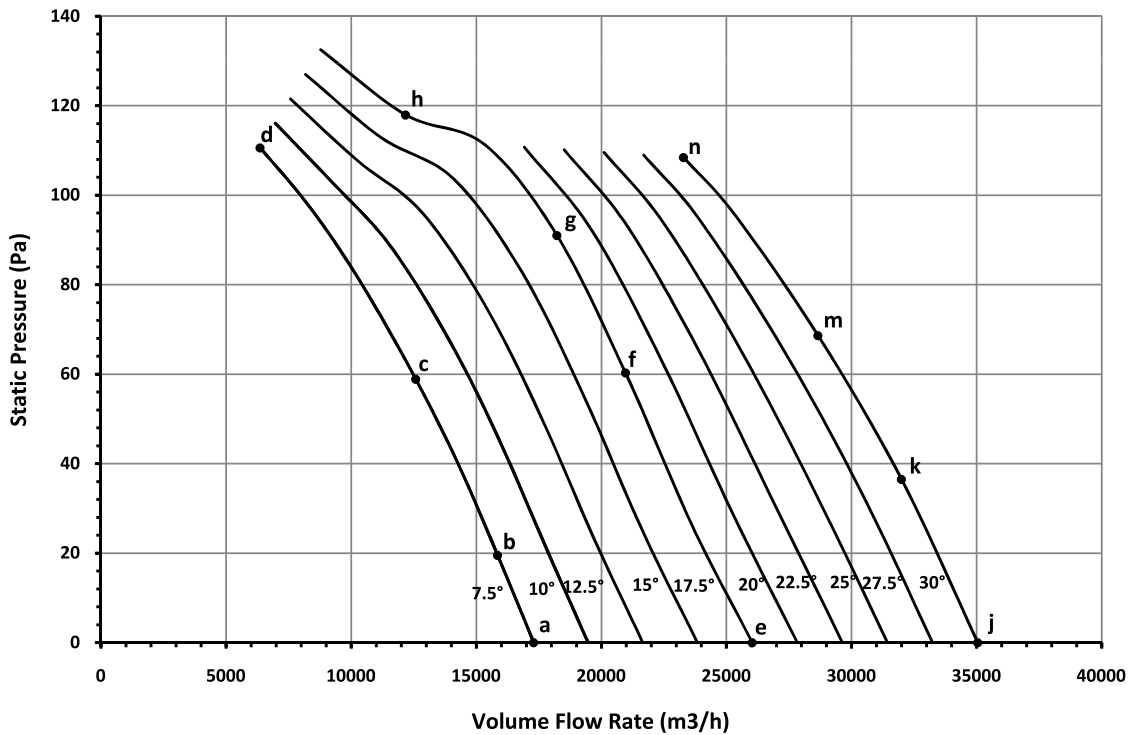
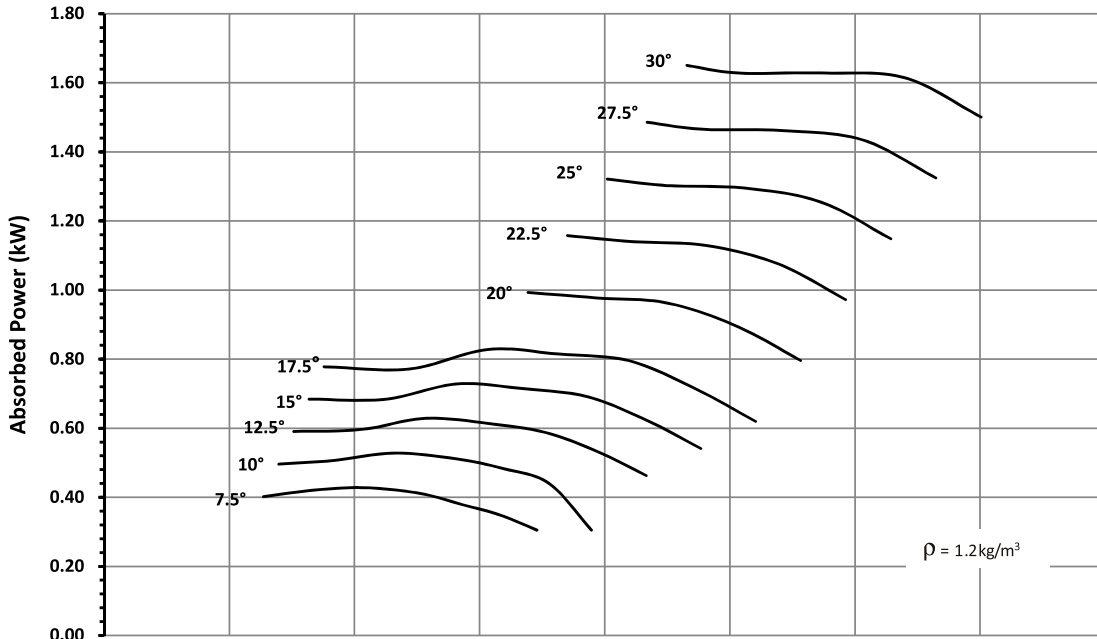

Ref	Full Octave Band Center Frequency								L _{WA} dB(A)
	63	125	250	500	1K	2K	4K	8K	
a	73	78	78	78	74	75	70	65	81
b	73	76	77	79	77	76	71	66	82
c	72	76	84	84	80	75	68	61	85
d	80	92	88	81	76	71	65	59	84
e	77	80	80	77	73	74	71	68	81
f	75	78	79	77	74	72	68	64	80
g	74	80	87	85	80	75	70	65	86
h	78	90	95	90	82	76	70	63	91
j	80	84	84	81	77	74	72	70	83
k	80	83	83	81	77	74	72	70	83
m	79	82	82	81	78	75	73	71	84
n	80	84	85	83	80	76	74	72	85



Performance certified is for Installation type D: Ducted Inlet- Ducted Outlet. Performance ratings do not include the effects of appurtenances (accessories) Power rating kW is fan input power. The Sound Power Level ratings shown are in decibels, referred to 10⁻¹² watts, calculated per AMCA International Standard 301. Values shown are for inlet L_{WA} and L_{WA} sound power levels for Installation type D: Ducted Inlet-Ducted Outlet. Ratings include the effects of duct end correction. The A-weighted sound ratings shown have been calculated per AMCA International Standard 301.

Performance Curve FEG 63

ADTA 1000-400-08
ADTA-F 1000-400-08

50Hz 720 rpm

Outlet Area: 0.785 m²

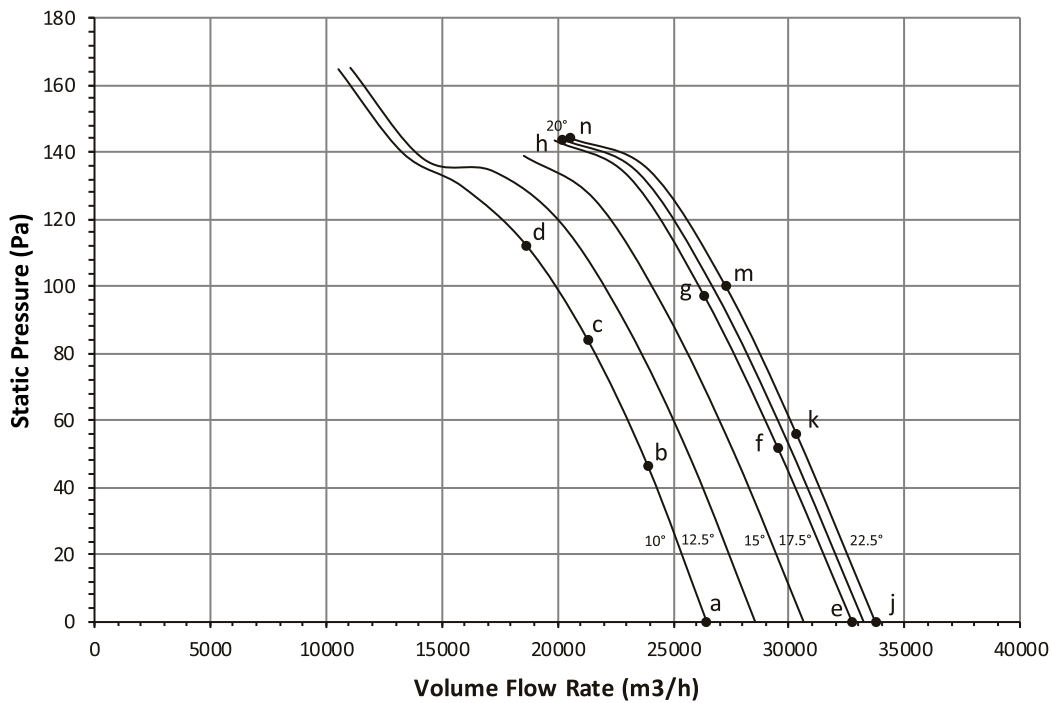
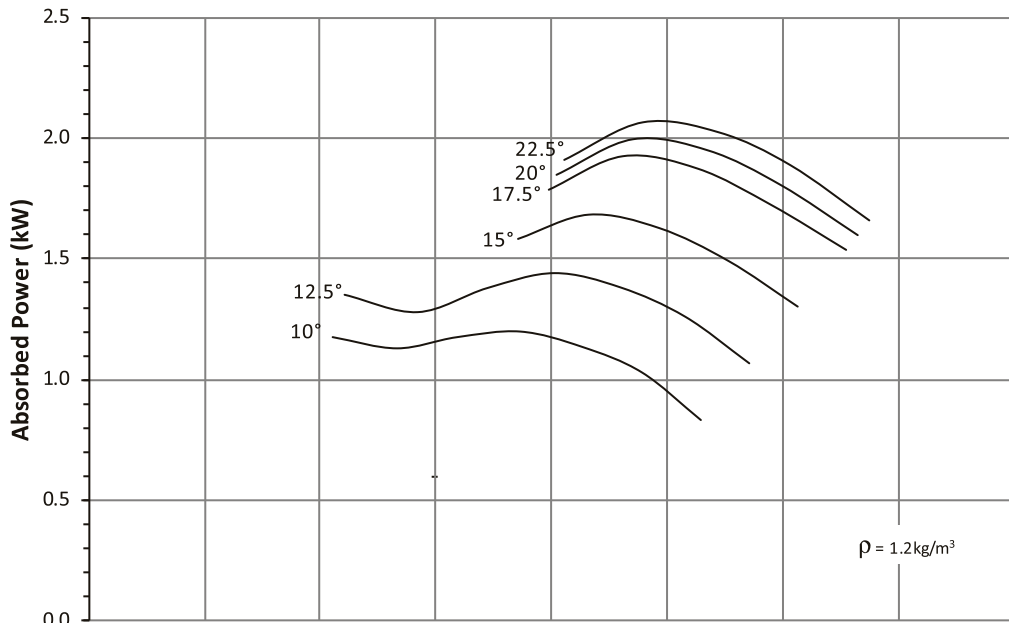

Ref	Full Octave Band Center Frequency							L _{WA} dB(A)	
	63	125	250	500	1K	2K	4K		8K
a	76	81	81	78	74	73	71	69	81
b	77	80	81	78	75	74	70	66	81
c	78	83	86	83	80	77	71	65	86
d	82	90	90	89	83	77	71	65	89
e	79	83	83	80	76	74	69	64	83
f	79	83	83	79	75	74	69	64	82
g	80	84	84	82	79	76	72	68	84
h	86	93	94	87	83	78	73	68	90
j	79	83	83	80	76	74	69	64	83
k	80	84	84	79	76	75	69	63	83
m	80	84	85	82	79	76	72	68	85
n	86	93	94	86	82	78	73	68	89



Performance certified for Installation type D: Ducted Inlet- Ducted Outlet. Performance ratings do not include the effects of appurtenances (accessories). Power rating kW is fan input power. The Sound Power Level ratings shown are in decibels, referred to 10⁻¹² watts, calculated per AMCA International Standard 301. Values shown are for inlet L_w and L_{wA} sound power levels for Installation type D: Ducted Inlet-Ducted Outlet. Ratings include the effects of duct end correction. The A-weighted sound ratings shown have been calculated per AMCA International Standard 301.

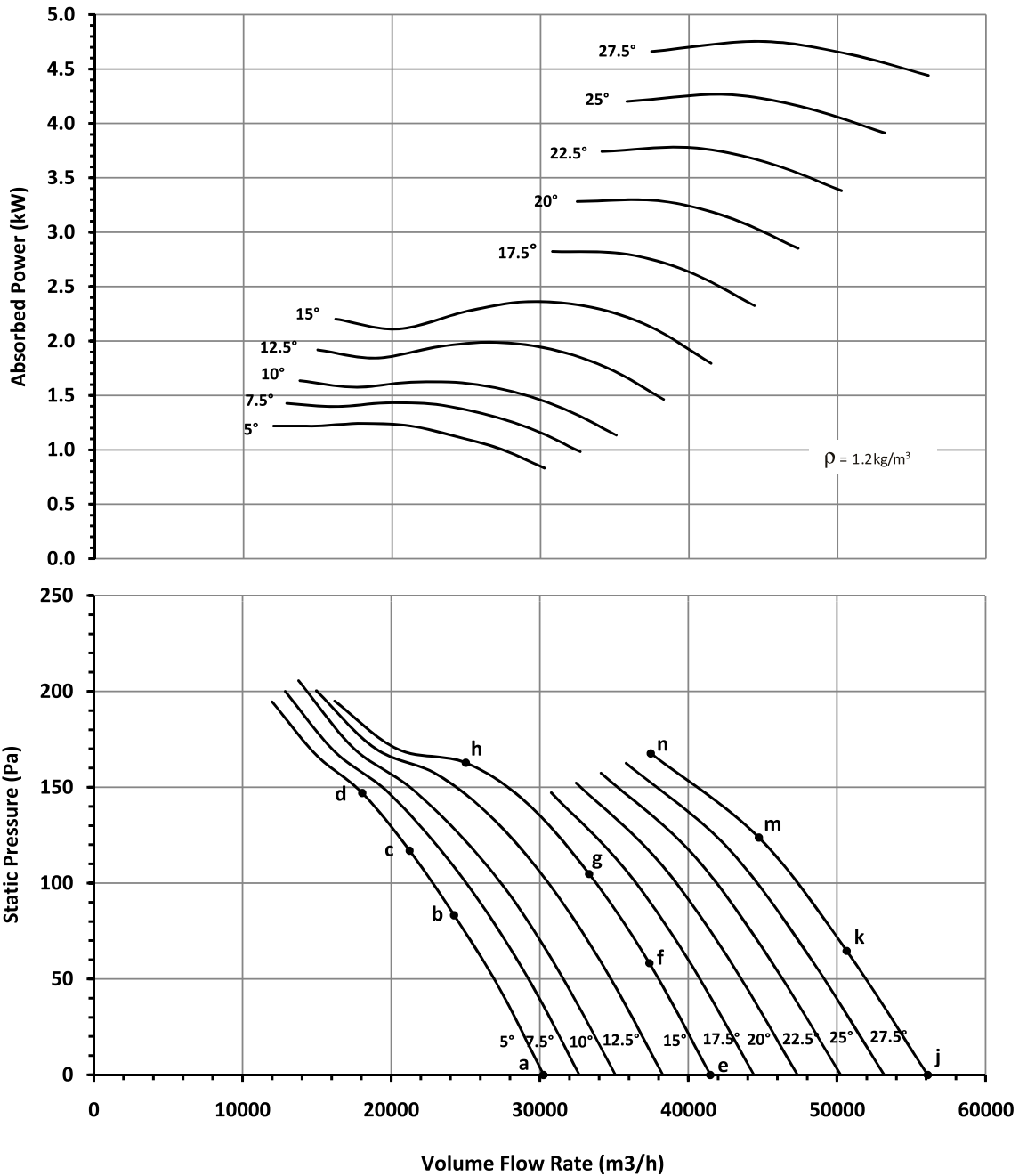

Ref	Full Octave Band Center Frequency								L _{WA} dB(A)
	63	125	250	500	1K	2K	4K	8K	
a	76	80	83	82	78	76	76	76	85
b	76	84	89	90	87	82	75	68	91
c	80	90	90	90	85	80	73	66	91
d	86	92	92	88	83	78	72	66	90
e	80	86	86	82	77	75	73	71	85
f	79	84	85	81	79	77	73	69	85
g	81	87	87	87	84	81	76	71	89
h	98	96	97	89	85	80	74	68	92
j	92	89	87	86	82	79	77	74	88
k	95	90	87	86	83	80	78	75	89
m	93	90	86	86	83	81	79	76	89
n	94	95	91	90	86	82	78	74	92



Performance certified is for Installation type D: Ducted Inlet- Ducted Outlet. Performance ratings do not include the effects of appurtenances (accessories). Power rating kW is fan input power. The Sound Power Level ratings shown are in decibels, referred to 10⁻¹² watts, calculated per AMCA International Standard 301. Values shown are for outlet L_{WD} and L_{WA} sound power levels for Installation type D: Ducted Inlet-Ducted Outlet. Ratings include the effects of duct end correction. The A-weighted sound ratings shown have been calculated per AMCA International Standard 301.

Performance Curve FEG 75

ADTA 1250-400-08
ADTA-F 1250-400-08

50Hz 720rpm

Outlet Area: 1.227 m²

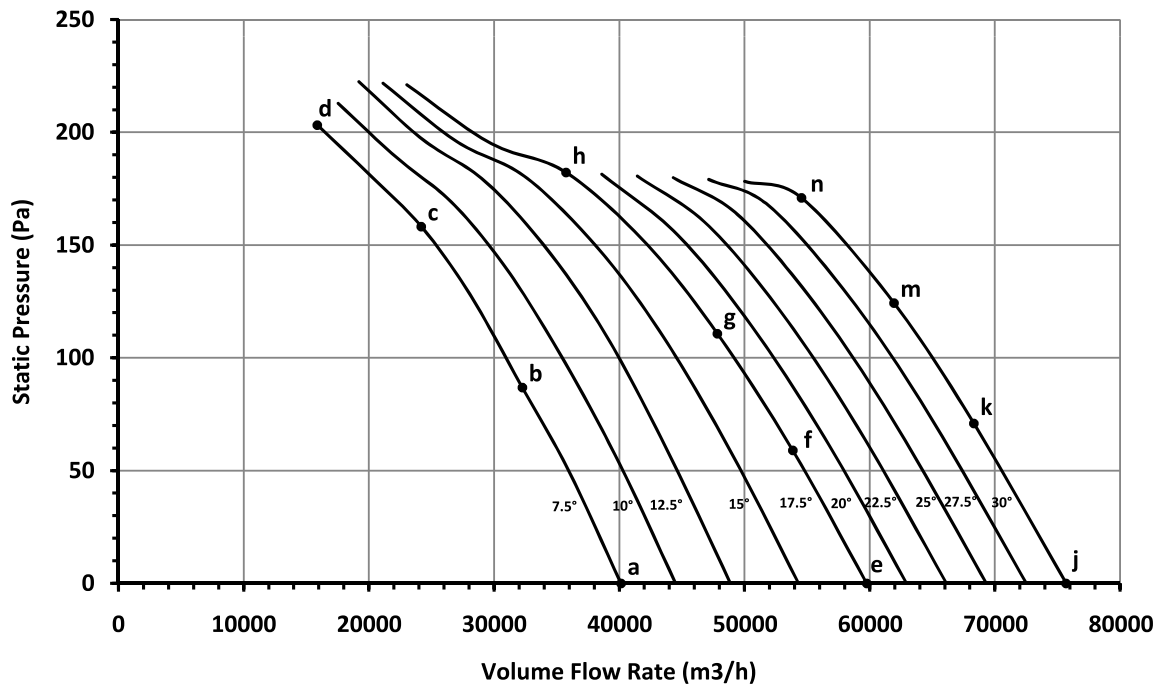
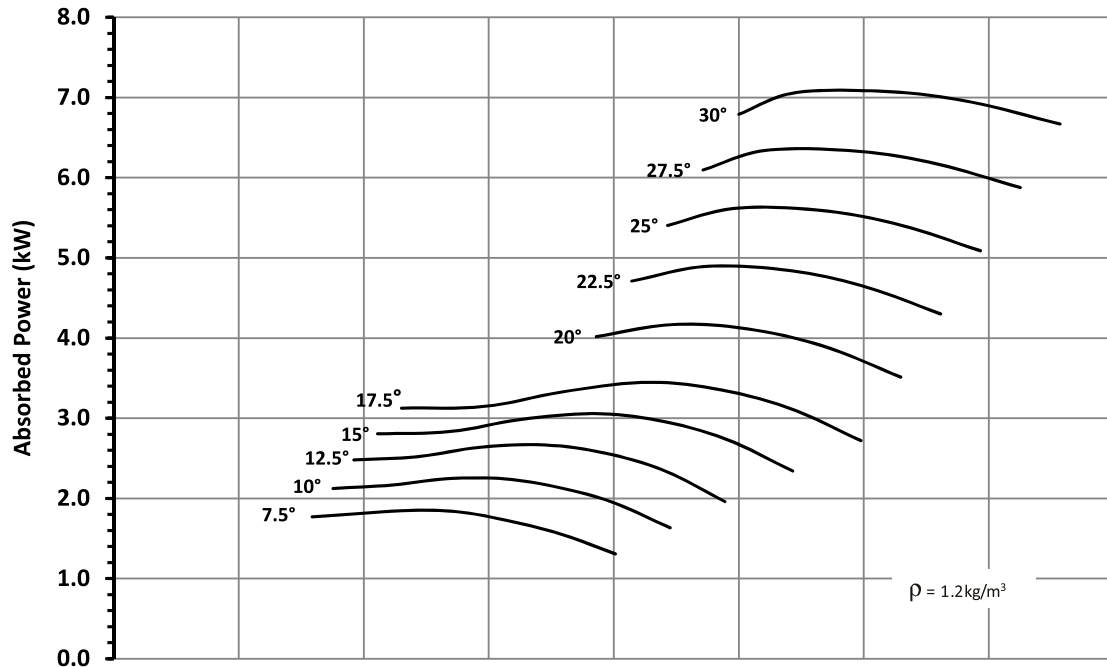

Ref	Full Octave Band Center Frequency								L _{W0} A dB(A)
	63	125	250	500	1K	2K	4K	8K	
a	78	83	87	86	82	79	80	81	89
b	78	87	92	93	89	84	78	72	94
c	87	94	94	91	86	81	76	71	92
d	95	92	92	87	83	80	76	72	90
e	85	90	87	86	81	79	79	79	89
f	82	90	88	87	84	81	79	77	90
g	87	93	93	92	89	85	80	75	94
h	92	102	97	94	89	84	79	74	96
j	100	95	90	89	86	82	80	78	91
k	99	94	90	89	86	83	81	79	92
m	97	94	90	89	87	84	82	80	92
n	98	98	97	95	91	86	82	77	96



Performance certified is for Installation type D: Ducted Inlet- Ducted Outlet. Performance ratings do not include the effects of appurtenances (accessories) Power rating kW is fan input power. The Sound Power Level ratings shown are in decibels, referred to 10⁻¹² watts, calculated per AMCA International Standard 301. Values shown are for outlet L_{W0} and L_{W0}A sound power levels for Installation type D: Ducted Inlet-Ducted Outlet. Ratings include the effects of duct end correction. The A-weighted sound ratings shown have been calculated per AMCA International Standard 301.

Performance Curve FEG 75

ADTA 1250-400-12
ADTA-F 1250-400-12

50Hz 720rpm

Outlet Area: 1.227 m²

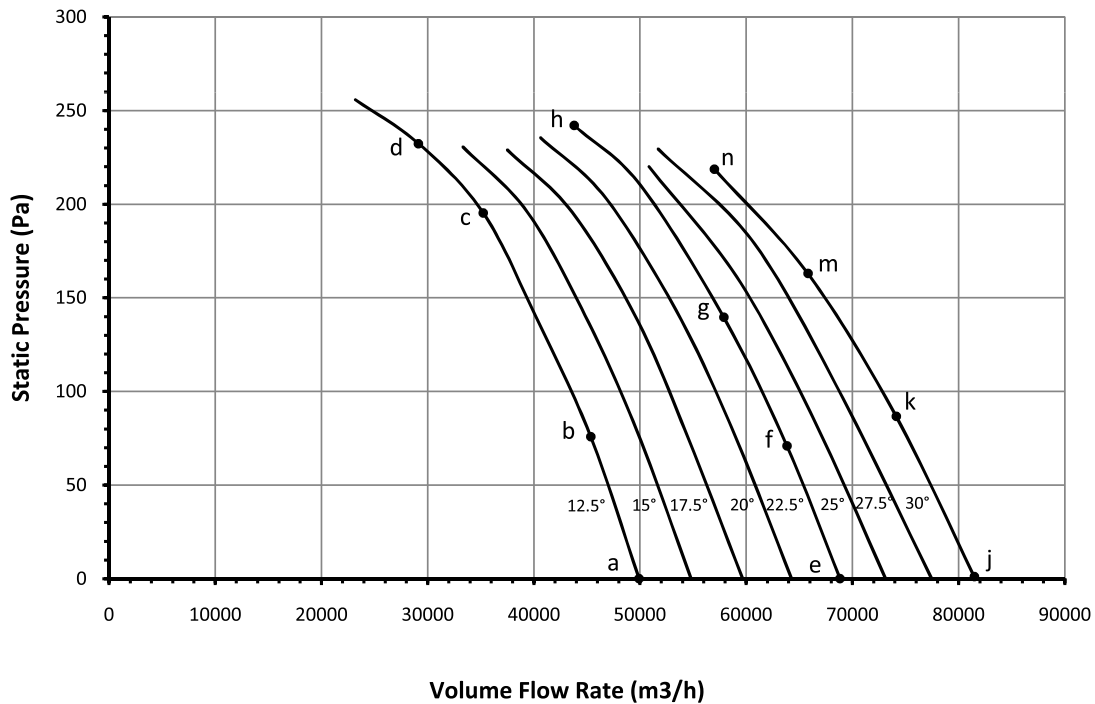
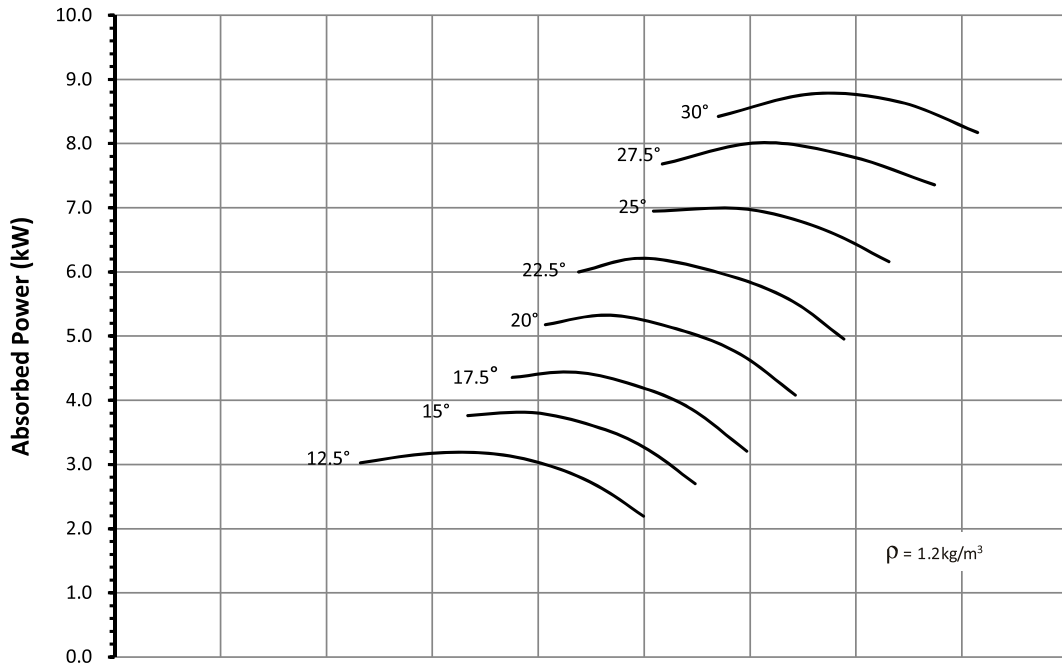

Ref	Full Octave Band Center Frequency								L _{W0A} dB(A)
	63	125	250	500	1K	2K	4K	8K	
a	87	90	90	86	85	84	81	75	93
b	86	89	89	87	87	86	81	74	94
c	86	99	98	94	90	85	79	72	98
d	92	103	102	92	89	84	78	72	98
e	92	92	92	88	85	83	80	77	93
f	93	91	91	87	85	82	80	77	93
g	90	91	91	89	87	84	81	78	94
h	95	99	98	96	92	87	82	77	97
j	94	93	92	89	87	84	81	79	94
k	95	91	92	90	87	84	82	80	93
m	92	94	93	91	89	86	83	80	96
n	99	102	97	97	93	89	83	79	98



Performance certified is for Installation type D: Ducted Inlet- Ducted Outlet. Performance ratings do not include the effects of appurtenances (accessories) Power rating kW is fan input power. The Sound Power Level ratings shown are in decibels, referred to 10-12 watts, calculated per AMCA International Standard 301. Values shown are for outlet L_{w0} and L_{w0A} sound power levels for Installation type D: Ducted Inlet-Ducted Outlet. Ratings include the effects of duct end correction. The A-weighted sound ratings shown have been calculated per AMCA International Standard 301.

Performance Curve
FEG 67

ADTA 1400-400-08
ADTA-F 1400-400-08

50Hz 720rpm

Outlet Area: 1.550 m²

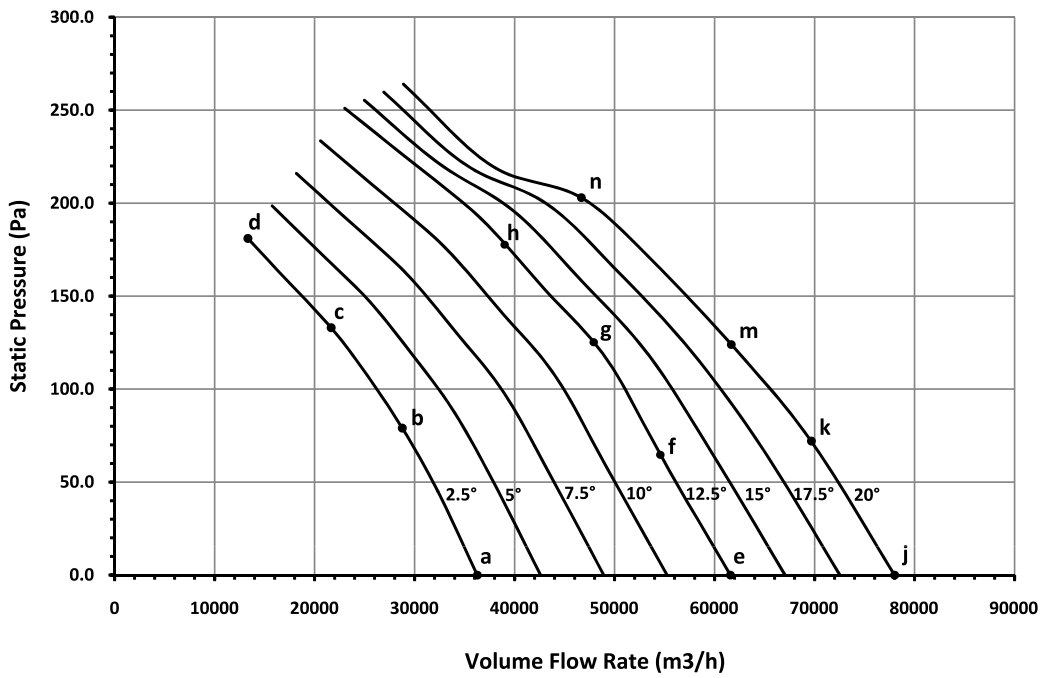
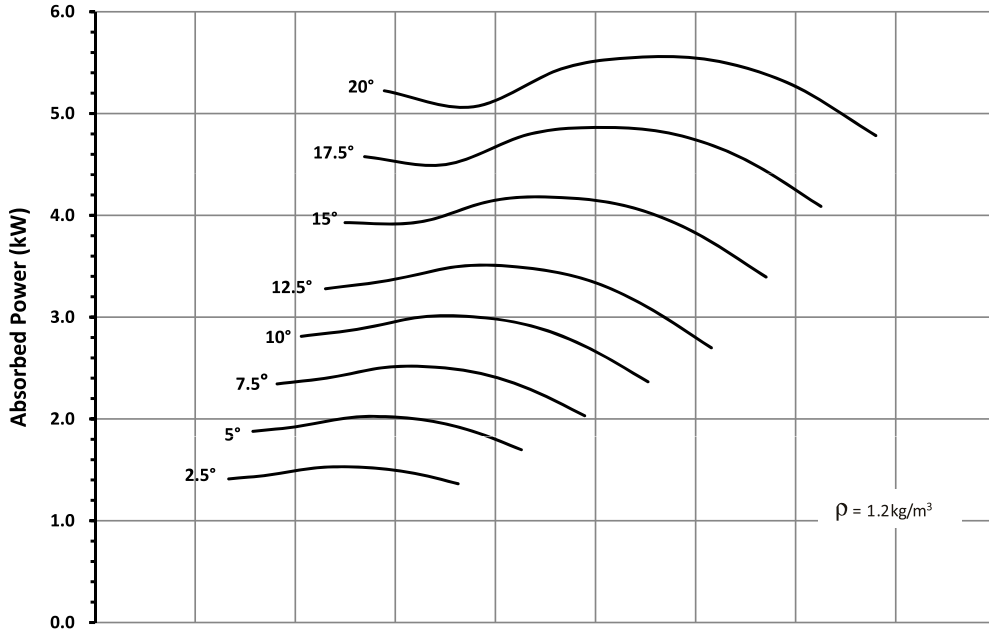

Ref	Full Octave Band Center Frequency								L _{W0A} db(A)
	63	125	250	500	1k	2k	4k	8k	
a	83	85	92	92	89	86	83	71	94
b	83	90	95	92	88	84	80	69	94
c	86	94	92	88	86	82	77	69	91
d	89	90	86	84	83	80	77	70	88
e	86	86	86	91	93	89	85	75	96
f	86	86	89	91	93	89	84	75	96
g	86	89	94	94	93	87	83	75	96
h	86	97	97	94	91	86	82	76	96
j	89	92	88	91	93	89	84	76	96
k	87	91	92	94	94	89	84	78	97
m	88	92	97	97	94	89	85	78	99
n	101	99	96	92	91	87	83	77	96



Performance certified is for Installation type A: Free Inlet - Free Outlet. Performance ratings do not include the effects of appurtenances (accessories)
Power rating kW is fan input power.
The Sound Power Level ratings shown are in decibels, referred to 10⁻¹² watts, calculated per AMCA International Standard 301. Values shown are for outlet L_{W0} and L_{W0A} sound power levels for Installation type A: Free Inlet - Free Outlet. The A-weighted sound ratings shown have been calculated per AMCA International Standard 301.

Performance Curve FEG 60

ADTA 1400-400-12
ADTA-F 1400-400-12

50Hz 720 rpm

Outlet Area: 1.550 m²

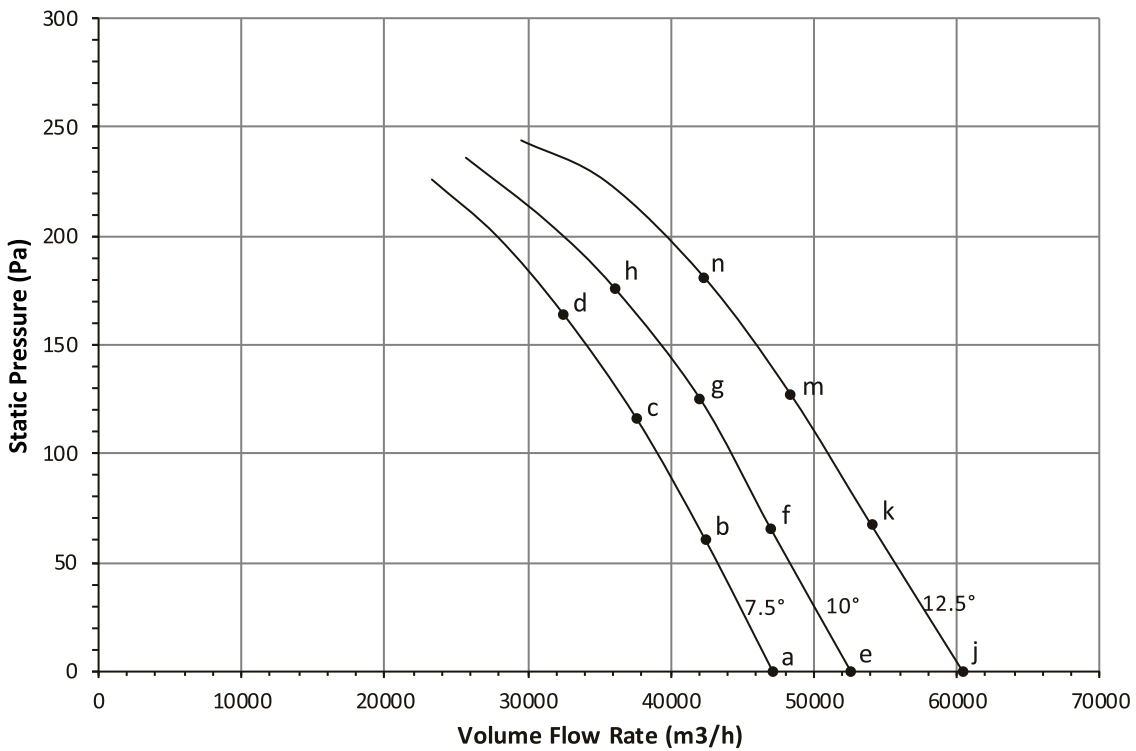
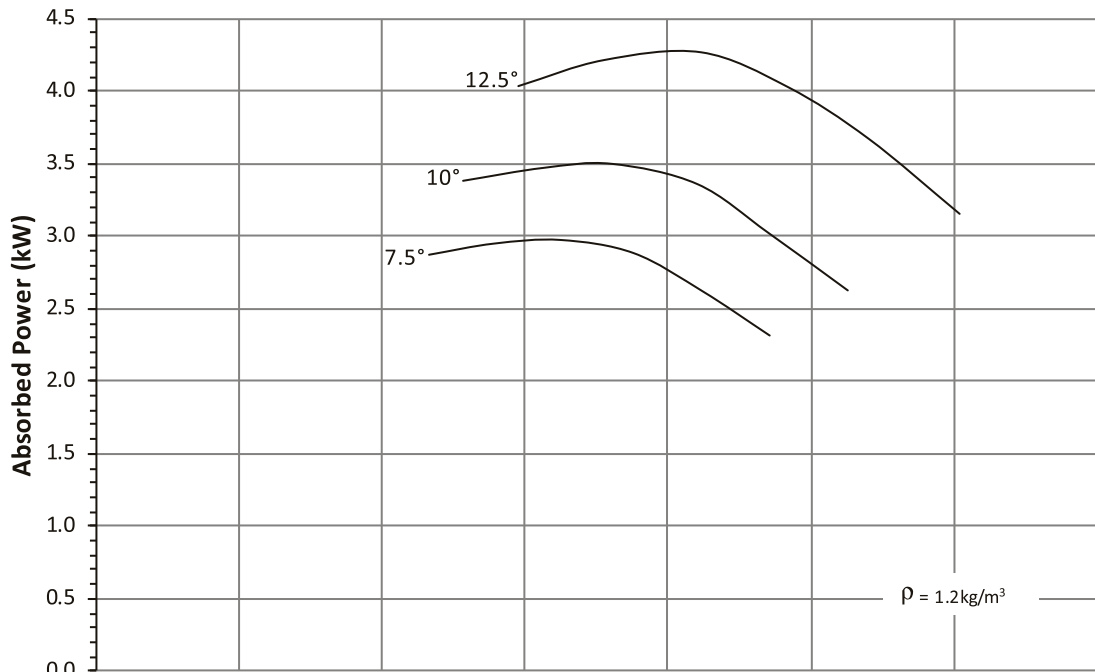

Ref	Full Octave Band Center Frequency								L _{WA} dB(A)
	63	125	250	500	1K	2K	4K	8K	
a	81	89	91	94	93	88	86	74	97
b	82	92	94	96	93	88	83	73	97
c	85	95	96	96	92	87	82	71	97
d	86	97	97	94	91	86	80	70	96
e	84	89	90	94	94	89	86	75	98
f	86	93	93	97	94	88	84	74	98
g	86	97	96	97	93	88	82	72	98
h	87	97	97	95	92	87	81	71	97
j	84	88	89	93	95	91	87	76	98
k	85	93	93	97	95	89	84	74	99
m	87	99	97	98	94	88	83	73	99
n	89	99	98	96	93	88	82	72	98



Performance certified is for Installation type A: Free Inlet-Free Outlet. Performance ratings do not include the effects of appurtenances (accessories)

Power rating kW is fan input power.

The Sound Power Level ratings shown are in decibels, referred to 10⁻¹² watts, calculated per AMCA International Standard 301. Values shown are for outlet L_{WA} and L_{WA}A sound power levels for Installation type A: Free Inlet - Free Outlet. The A-weighted sound ratings shown have been calculated per AMCA International Standard 301.

Performance Curve
FEG 67

ADTA 1600-400-08
ADTA-F 1600-400-08

50Hz 720 rpm

Outlet Area: 2.023 m²

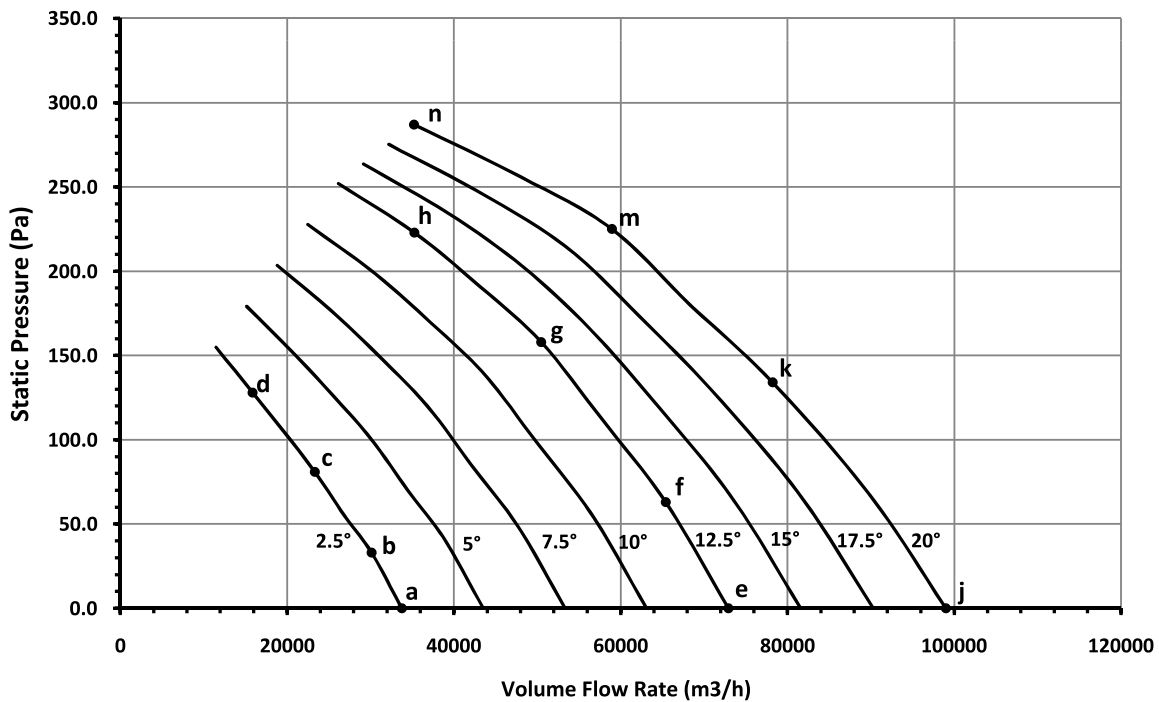
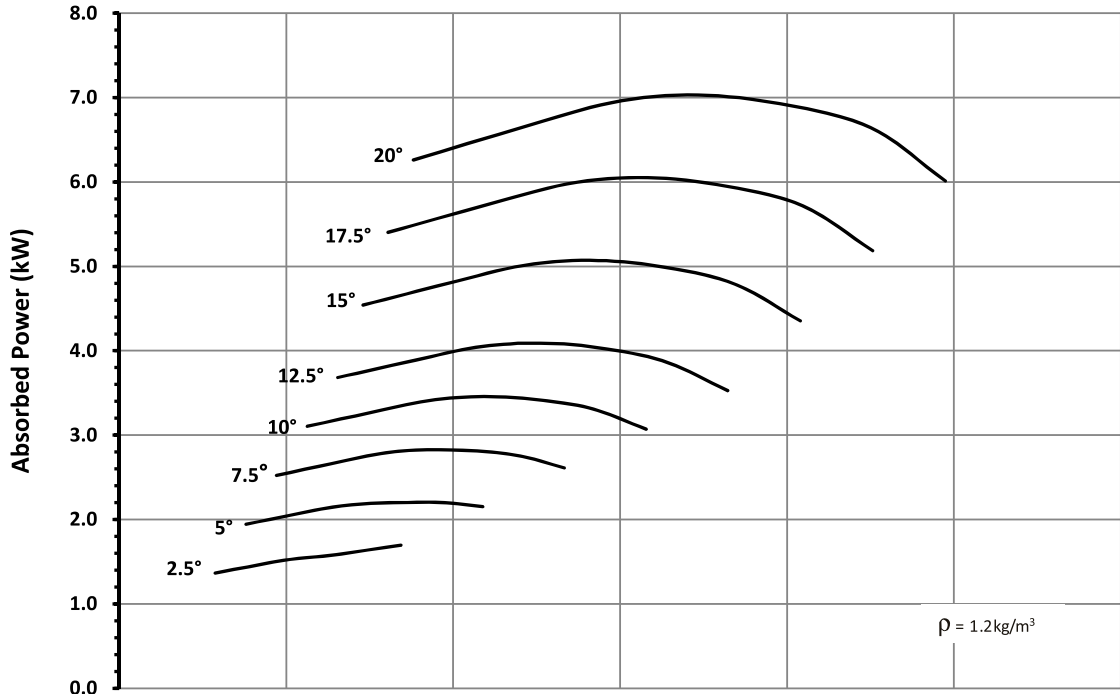

Ref	Full Octave Band Center Frequency								L _{WA} dB(A)
	63	125	250	500	1K	2K	4K	8K	
a	90	94	96	94	92	87	84	74	96
b	89	93	94	93	92	87	84	73	96
c	88	90	90	90	90	86	84	74	94
d	89	90	89	89	89	85	85	77	93
e	88	90	94	96	96	90	89	77	99
f	87	92	96	97	95	89	87	75	99
g	85	93	98	96	92	87	83	75	97
h	89	96	95	91	89	85	82	76	94
j	91	91	93	96	97	92	89	80	100
k	91	93	99	99	96	91	86	79	100
m	89	96	99	98	94	90	86	81	99
n	95	96	95	93	91	89	85	82	96



Performance certified is for Installation type A: Free Inlet-Free Outlet. Performance ratings do not include the effects of appurtenances (accessories). Power rating kW is fan input power. The Sound Power Level ratings shown are in decibels, referred to 10⁻¹² watts, calculated per AMCA International Standard 301. Values shown are for outlet L_{WA} and L_{WA}A sound power levels for Installation type A: Free Inlet - Free Outlet. The A-weighted sound ratings shown have been calculated per AMCA International Standard 301.

Performance Curve FEG 56

ADTA 1600-400-16
ADTA-F 1600-400-16

50Hz 720 rpm

Outlet Area: 2.023 m²

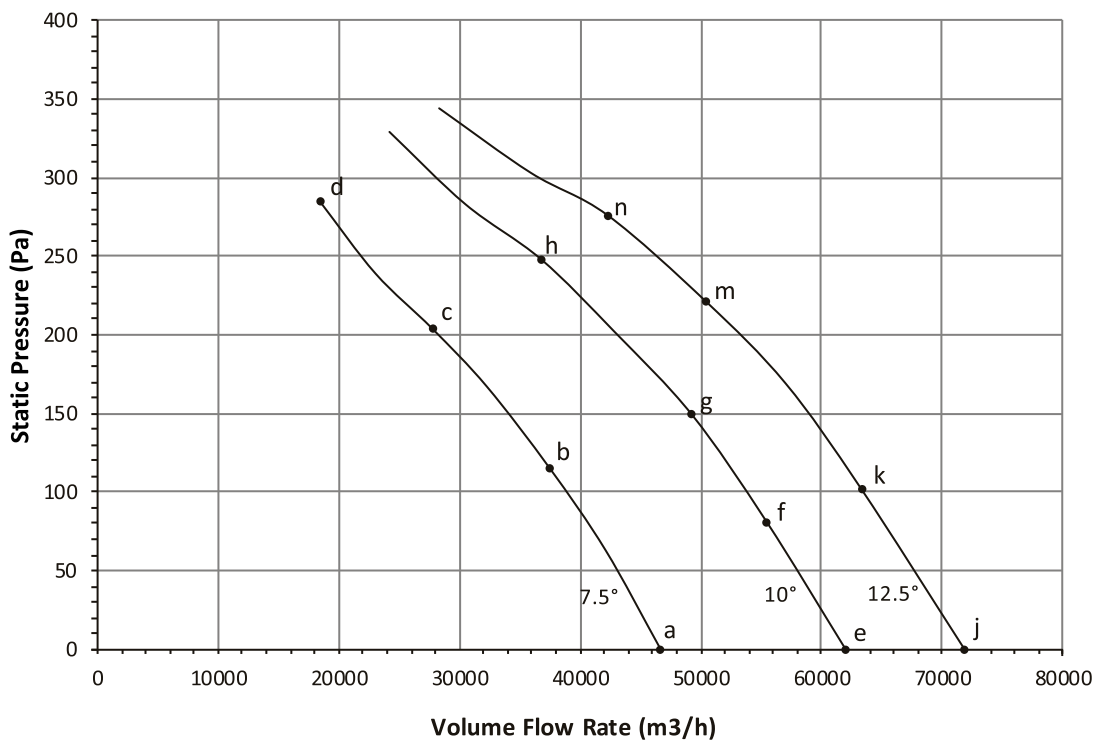
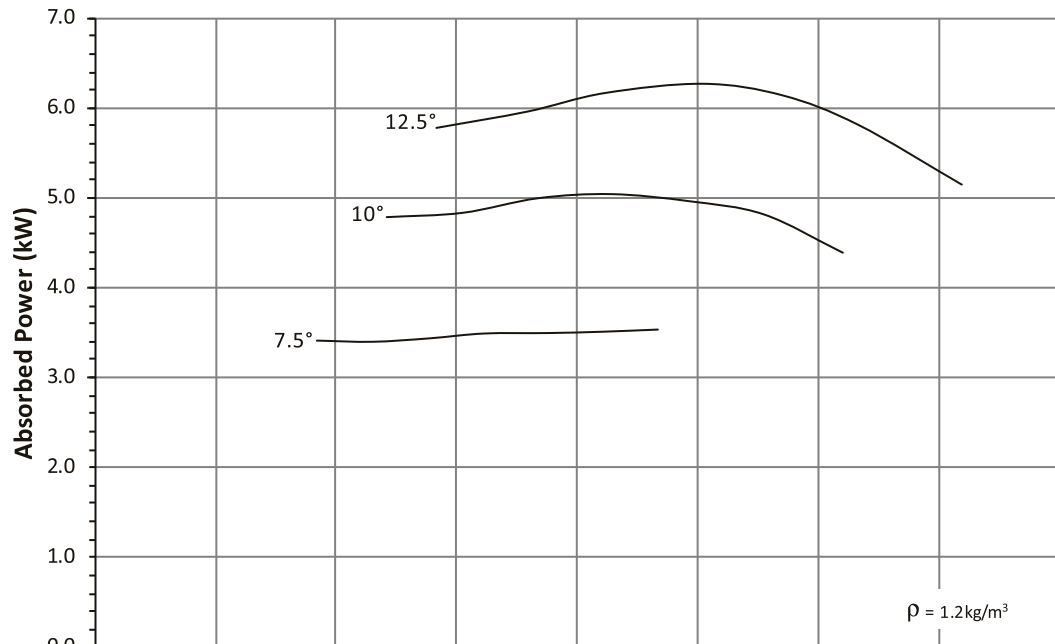

Ref	Full Octave Band Center Frequency								L _{WcA} dB(A)
	63	125	250	500	1K	2K	4K	8K	
a	87	96	99	96	95	91	89	81	99
b	87	105	97	95	94	90	86	77	99
c	86	101	95	93	93	88	83	78	97
d	84	94	93	91	91	87	83	79	95
e	86	91	100	99	96	92	90	80	101
f	85	96	101	98	96	92	89	78	101
g	86	101	100	97	96	91	87	76	100
h	87	106	98	95	95	89	84	74	99
j	88	91	99	100	97	92	91	80	102
k	88	95	102	100	97	92	88	78	102
m	87	103	101	97	96	91	86	76	101
n	88	106	99	96	95	90	84	76	99



Performance certified is for Installation type A: Free Inlet - Free Outlet. Performance ratings do not include the effects of appurtenances (accessories). Power rating kW is fan input power. The Sound Power Level ratings shown are in decibels, referred to 10⁻¹² watts, calculated per AMCA International Standard 301. Values shown are for outlet L_{Wc} and L_{WcA} sound power levels for Installation type A: Free Inlet - Free Outlet. The A-weighted sound ratings shown have been calculated per AMCA International Standard 301.

Nomenclature

When ordering Nicotra Gebhardt Axial fans, please specify your requirements in the followings sequence to avoid confusion.

1. Fan Type and Performance Data
 - Fan Type: ADTA, ADTA-F
 - Capacity
 - Static Pressure

2. Electric Motor Details
 - Power, main supply, voltage, frequency, 50 Hz or 60 Hz type
 - Motor Speed, Polarity
 - Insulation (Class F, Class H, etc)

3. Impeller Material
 - Glass Reinforced Nylon, GRN
 - Aluminium, ALU
 - Anti Static GRN

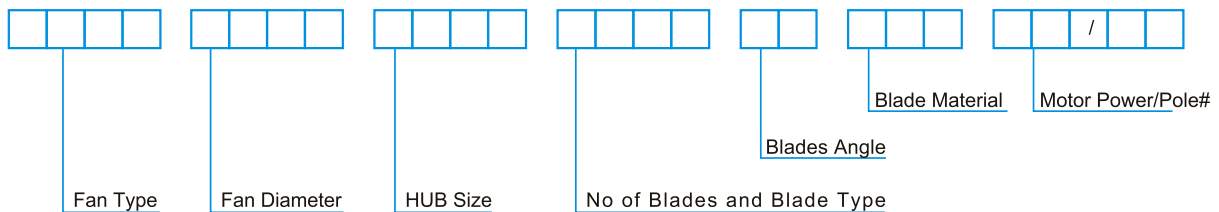

Description (Sample)

ADTA1000/400/08C/20.0/ALU-18.5/4P

ADTA	Long Case Drive
1000	Fan Diameter = 1000mm
400T	Hub Size
8C	Blade type C, Qty = 8
20°	Blade Angle 20 Deg
ALU	ALU Material



Appendix

Wiring Diagram For Various Application

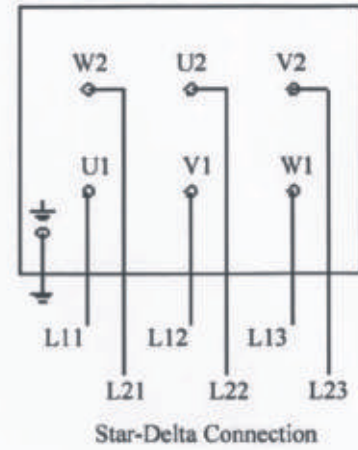
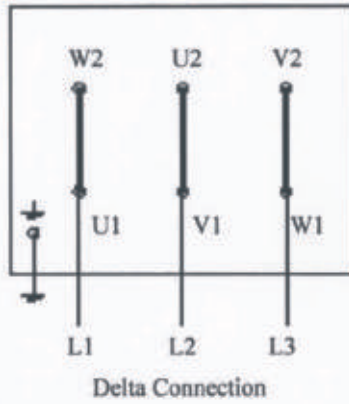
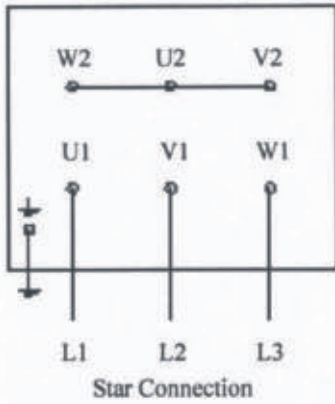

Multi-speed with 2 separate Windings

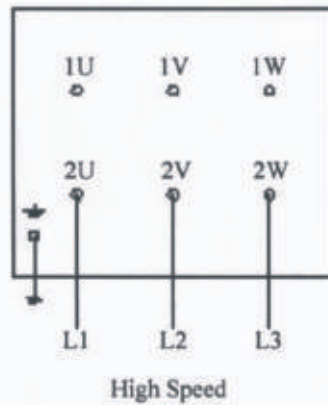
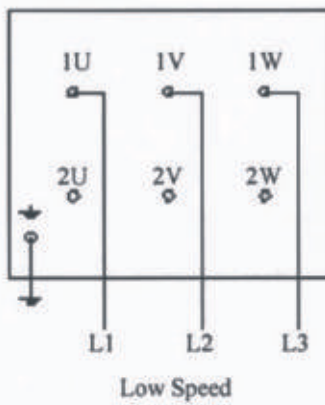

Multi-speed motors in Dahlander Connection (tapped winding)

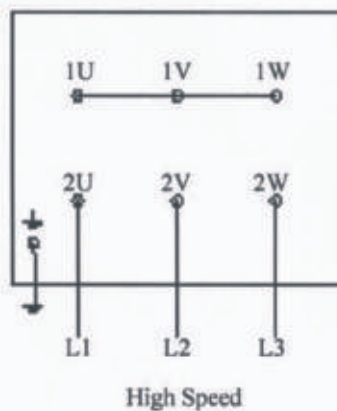
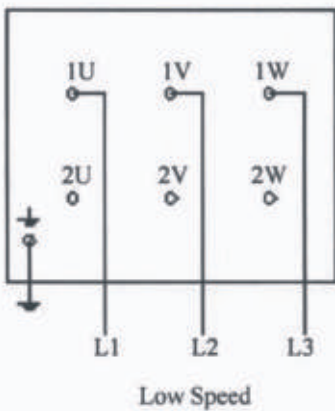

WORLDWIDE LOCATIONS

NICOTRA-GEGBHARDT.COM

AUSTRALIA

Regal Beloit Australia Pty Ltd
Melbourne Office
19 Corporate Ave (PO Box 2340)
Rowville VIC 3178
Phone 1 300 888 853
Fax +61 3 9237 4050

BELGIUM

Nicotra Gebhardt Belgique
Allée des Artisan, 18
4130 Esneux
Phone +32 (0)42288580
Fax +32 (0)42288580
E-mail info@nicotra.be

CHINA

Nicotra Gebhardt (Guangzhou) Co. Ltd. - China
88 Tai'An Road, XinQiao, ShiJi, Panyu
Guangzhou 511450
PR CHINA
Phone +86 (0)20-2293 5700
Fax +86 (0)20-2293 5701
E-mail sales@nicotra-china.com

FRANCE

Nicotra Gebhardt S.p.A.
Leader's Park Bat A1
3 chemin des Cytises
69340 Francheville
Phone +33 (0)4 72 79 01 20
Fax +33 (0)4 72 79 01 21
E-mail ngfrance@nicotra-gebhardt.com

GREAT BRITAIN

Nicotra Gebhardt Ltd - UK
Unit D, Rail Mill Way
Parkgate Business Park
Rotherham
South Yorkshire
S62 6JQ
Phone +044 01709-780760
Fax +044 01709-780762
E-mail sales@nicotra.co.uk

INDIA

Nicotra India PVT Ltd - India
Plot no 28F & 29, Sector-31,Kasna,
Greater Noida-201 308 U.P (India)
Phone +91 120 4783400
Phone +91 22 65702056 (Mumbai)
Phone +91 80 25727830 (Bangalore)
E-mail info@nicotraindia.com

NEW ZEALAND

Regal Beloit New Zealand Limited
Auckland office
18 Jomac Place
Avondale, Auckland 1026
Phone 0800 676722
Fax +64 9 820 8504



SPAIN

Nicotra Gebhardt Espana
C/ Jamaica, 5
Apdo. Correos 5077
28806 Alcalá de Henares
Phone +34 918-846110
Fax +34 918-859450
E-mail info.es@nicotra-gebhardt.com

SINGAPORE

Nicotra Gebhardt PTE LTD
12 Tuas Loop
Singapore 637346
Phone +65 6863 3473
Fax +65 6863 3476
E-mail info_singapore@nicotra-gebhardt.com

SWEDEN

Nicotra Gebhardt A.B
Box 237
Kratetorpsgatan 30
43153 Mölndal
Phone +46 (0)311302610
E-mail info.se@nicotra-gebhardt.com

THAILAND

Nicotra Gebhardt Co LTD
6/29 Soi Suksawadi 2, Moo 4, Suksawadi Road,
Kwang Jomthong, Khet Jomthong,
Bangkok 10150
Phone +662 476-1823-6
Fax +662 476-1827
E-mail sales@nicotra.co.th

UNITED STATES

Regal Beloit Corporation
200 State St.
Beloit, WI 53511
Phone 001(608) 364-8800
E-mail info.ng.us@regalbeloit.com
Web www.regalbeloit.com

NICOTRA||Gebhardt®

Nicotra Gebhardt Germany

Nicotra Gebhardt GmbH
Gebhardtstraße 19-25
74638 Waldenburg (Germany)
Phone +49 7942 1010
Fax +49 7942 101 170
E-Mail info.ng.de@regalbeloit.com
Web www.nicotra-gebhardt.com

Nicotra Gebhardt Italy

Regal Beloit Italy S.p.A.
Via Modena, 18
24040 Zingonia (BG) (Italy)
Phone +39 035 873 111
Fax +39 035 884 319
E-mail info.ng.it@regalbeloit.com
Web www.nicotra-gebhardt.com

APPLICATION CONSIDERATIONS

The proper selection and application of products and components, including the related area of product safety, is the responsibility of the customer. Operating and performance requirements and potential associated issues will vary appreciably depending upon the use and application of such products and components. The scope of the technical and application information included in this publication is necessarily limited. Unusual operating environments and conditions, lubrication requirements, loading supports, and other factors can materially affect the application and operating results of the products and components and the customer should carefully review its requirements. Any technical advice or review furnished by Regal Beloit America, Inc. and/or its affiliates ("Regal Rexnord Corp") with respect to the use of products and components is given in good faith and without charge, and Regal Rexnord Corp assumes no obligation or liability for the advice given, or results obtained, all such advice and review being given and accepted at customer's risk.

For a copy of our Standard Terms and Conditions of Sale, please visit <https://www.regalbeloit.com/Terms-and-Conditions-of-Sale>. These terms and conditions of sale, disclaimers and limitations of liability apply to any person who may buy, acquire or use a Regal Rexnord Corp product referred to herein, including any person who buys from a licensed distributor of these branded products.