



Range of low profile in-line mixed-flow fans for circular ducts. The range comprises seven diameters and covers a flow range from 210 to 1840 m<sup>3</sup>/h. The unique design of the support bracket allows the motor and impeller assembly to be fitted or removed without dismantling the adjacent ducting.

Low profile compact casing manufactured in tough reinforced plastic. Optimised design of the impeller, guide vane and outlet diffuser, to increase performance and lower the sound level. Airtight construction with double-injection sealing between the main body and the support bracket to avoid air leaks. Rubber gaskets on the flanges to improve airtightness with the ducts. Silent-block between the motor and the guide vane to reduce the motor's vibrations and lower the sound level of the installation, even in terms of speed regulation.

**Motor**

- Fitted with a 3-speed single-phase AC motor:
- 220-240V 50/60Hz, Class F, IP 44.
- Motor also speed controllable by voltage in high speed.
- Thermal protection with manual reset.
- Working temperature: -20/60°C.

**TD EVO-T models**

TD EVO version fitted with a run-on-timer adjustable within 1 and 30 minutes and a 3-speed motor not suitable for speed control.

**TD EVO-VAR models**

TD EVO version fitted with one-speed AC motor with integrated variable speed drive, adjustable run-on timer and analogic input 0-10V. The maximum speed performance curve correspond to the "HS" performance curves shown on the graphs.



DESIGNED FOR AN EASY INSTALLATION



S&P certifies that the TD-EVO shown herein are licensed to bear the AMCA Seal. The ratings shown are based on tests and procedures performed in accordance with AMCA Publication 211 and AMCA Publication 311 and comply with the requirements of the AMCA Certified Ratings Program

The TD EVO fans offer the ideal in-line duct fan solution for a wide range of general residential or commercial ventilation application into.



**VERY LOW PROFILE**

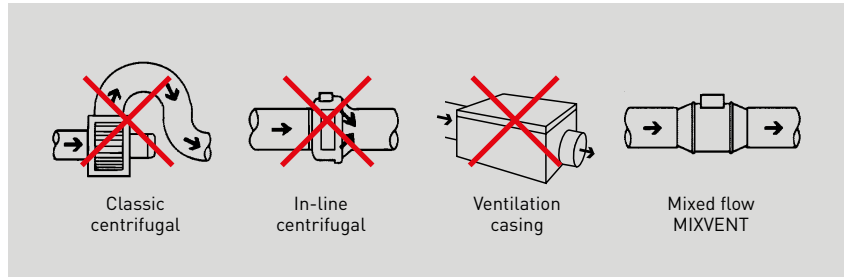

The low profile of the TD-EVO fans makes them the most effective solution for installations where the space of installation is limited such as false ceilings.

**EASY INSTALLATION AND MAINTENANCE**



Articulated fixing clamps with the possibility of mounting them from one side or the other, with conical profile for better airtightness with the main fan body and fixing by screws.

To reverse the direction of the airflow simply return the main fan body without having to disassemble the support foot. The rotation of the main fan body also allows to position the terminal box to allow the best accessibility.

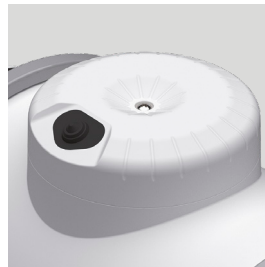

Circular duct connection with integrated rubber seals to allow airtight installation with duct system.

Pre-assembly of the main fan body on the support foot to ease handling / orientation of the product leaving the hands free to the installer.

Large size terminal box, closed by a single screw.

**HIGH PERFORMANCES**



**Silent-block**  
Silent-block between the motor and the support to reduce motor vibrations and lower the sound level of the fan.

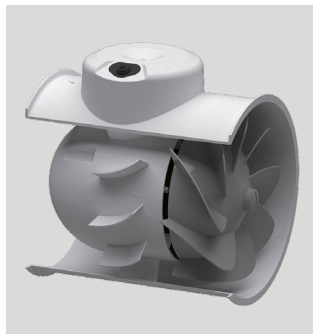

**Guide vane - outlet fairing**  
Optimised guide vane with outlet fairing to increase performance, efficiency and lower sound levels.

**EASY MAINTENANCE**



The unique design of the support bracket allows the motor and impeller assembly to be fitted or removed.

### TECHNICAL CHARACTERISTICS SPEED

Before installation check that the product electrical characteristics listed on the data plate label (voltage, power, frequency, etc.) match those of the intended electrical supply.

TD EVO Series	Speed (r.p.m.)	Maximum absorbed power (W)	Maximum absorbed current (A-230V)	Maximum air volume (m <sup>3</sup> /h)	Sound pressure level* (dB(A))			Max. Air temp. (°C @ 50Hz)	Weight (kg)	Speed controller	
					Inlet	Radiated	Outlet			REB	RMB
TD EVO-100	2450	16	0,1	210	32	19	31	-20/+60	1,7	REB-1 N	RMB-1,5
	2170	13	0,1	170	28	16	28				
	1960	12	0,1	150	25	13	25				
TD EVO-125	2320	29	0,1	310	36	26	37	-20/+60	1,8	REB-1 N	RMB-1,5
	1810	21	0,1	240	29	19	31				
	1600	19	0,1	210	27	17	28				
TD EVO-150	2610	45	0,2	560	44	32	45	-20/+60	3	REB-1 N	RMB-1,5
	2350	38	0,2	490	42	29	42				
	2110	33	0,1	430	39	26	39				
TD EVO-160	2600	45	0,2	560	44	32	45	-20/+60	3	REB-1 N	RMB-1,5
	2330	37	0,2	500	41	29	42				
	2090	33	0,1	440	38	26	39				
TD EVO-200	2700	107	0,5	900	47	33	47	-20/+60	4,1	REB-1 N	RMB-1,5
	2500	76	0,3	790	45	31	45				
	2280	64	0,3	710	42	28	43				
TD EVO-250	2710	181	0,8	1400	52	37	53	-20/+60	6,2	REB-1 N	RMB-1,5
	2520	153	0,6	1310	50	35	51				
	2290	132	0,5	1180	48	33	48				
TD EVO-315	2640	273	1,1	1840	56	40	55	-20/+60	8,4	REB-2,5 N	RMB-1,5
	2500	231	0,9	1730	55	38	53				
	2290	200	0,8	1620	53	36	51				

\* Sound pressure level measured at 3 m in free field condition, at the duty points 2, 5 and 8 of the performance curves.

TD EVO T Series	Speed (r.p.m.)	Maximum absorbed power (W)	Maximum absorbed current (A-230V)	Maximum air volume (m <sup>3</sup> /h)	Sound pressure level* (dB(A))			Max. Air temp. (°C @ 50Hz)	Weight (kg)	Timer (min.)
					Inlet	Radiated	Outlet			
TD EVO-100 T	2450	16	0,1	210	32	19	31	-20/+60	1,7	1-30
	2170	13	0,1	170	28	16	28			
	1960	12	0,1	150	25	13	25			
TD EVO-125 T	2320	29	0,1	310	36	26	37	-20/+60	1,8	1-30
	1810	21	0,1	240	29	19	31			
	1600	19	0,1	210	27	17	28			
TD EVO-150 T	2610	45	0,2	560	44	32	45	-20/+60	3	1-30
	2350	38	0,2	490	42	29	42			
	2110	33	0,1	430	39	26	39			
TD EVO-160 T	2600	45	0,2	560	44	32	45	-20/+60	3	1-30
	2330	37	0,2	500	41	29	42			
	2090	33	0,1	440	38	26	39			
TD EVO-200 T	2700	107	0,5	900	47	33	47	-20/+60	4,1	1-30
	2500	76	0,3	790	45	31	45			
	2280	64	0,3	710	42	28	43			
TD EVO-250 T	2710	181	0,8	1400	52	37	53	-20/+60	6,2	1-30
	2520	153	0,6	1310	50	35	51			
	2290	132	0,5	1180	48	33	48			
TD EVO-315 T	2640	273	1,1	1840	56	40	55	-20/+60	8,4	1-30
	2500	231	0,9	1730	55	38	53			
	2290	200	0,8	1620	53	36	51			

\* Sound pressure level measured at 3 m in free field condition, at the duty points 2, 5 and 8 of the performance curves.

# IN-LINE MIXED FLOW DUCT FANS TD-EVO Series



TD EVO VAR Series	Speed (r.p.m.)	Maximum absorbed power (W)	Maximum absorbed current (A-230V)	Maximum air volume (m³/h)	Sound pressure level* (dB(A))			Max. Air temp. (°C @ 50Hz)	Weight (kg)
					Inlet	Radiated	Outlet		
TD EVO-100 VAR	2450	16	0,1	210	32	19	31	-20/+60	1,7
TD EVO-125 VAR	2320	29	0,1	310	36	26	37	-20/+60	1,8
TD EVO-150 VAR	2610	45	0,2	560	44	32	45	-20/+60	3
TD EVO-160 VAR	2600	45	0,2	560	44	32	45	-20/+60	3
TD EVO-200 VAR	2700	107	0,5	900	47	33	47	-20/+60	4,1
TD EVO-250 VAR	2710	181	0,8	1400	52	37	53	-20/+60	6,2
TD EVO-315 VAR	2640	273	1,1	1840	56	40	55	-20/+60	8,4

\* Sound pressure level measured at 3 m in free field condition, at the duty points 2, 5 and 8 of the performance curves.

## DIMENSIONS (mm)

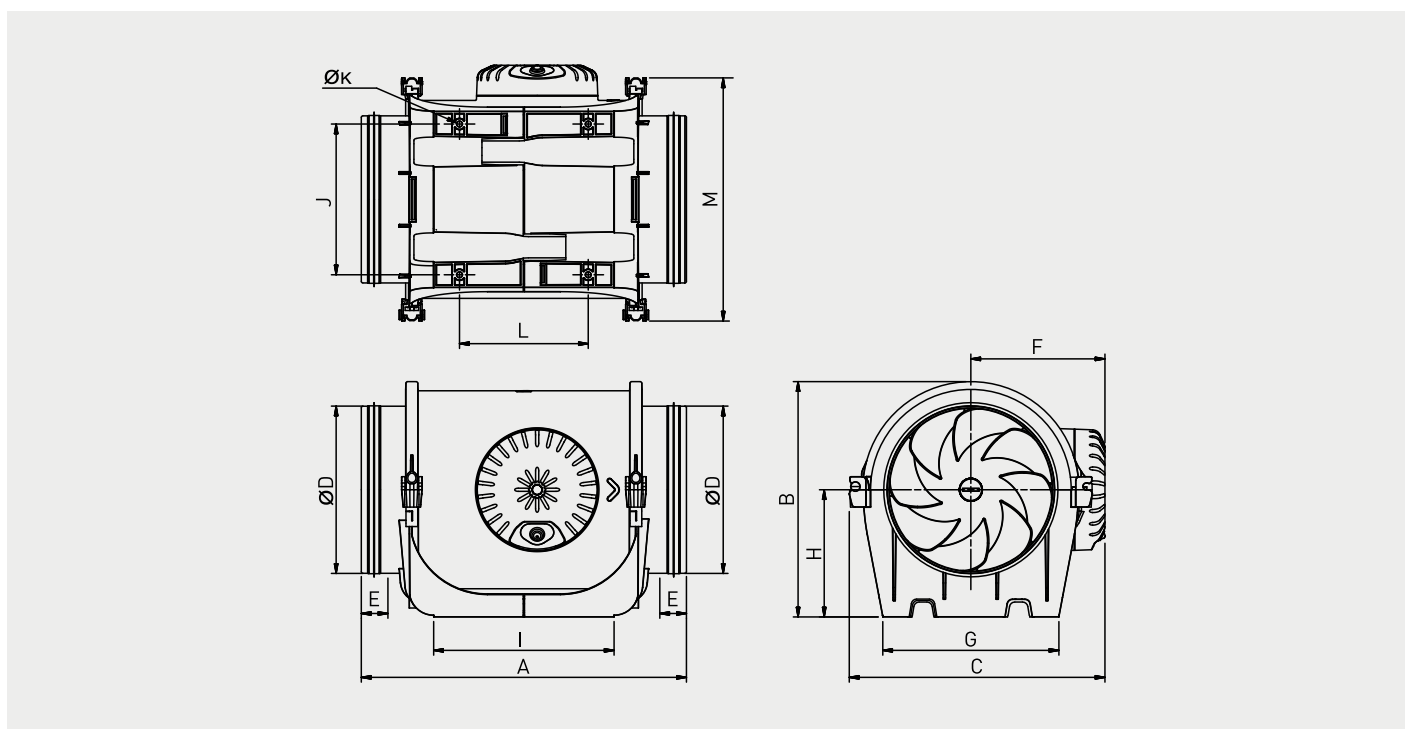

Model	A	B	C	ØD	E	F	G	H	I	J	ØK	L	M
TD EVO-100	302	181	201	97	28,5	107	133	100	168	100	4,5	89	189
TD EVO-125	302	191	221	122,5	28,5	117	132	100	172	104,5	4,5	91	209
TD EVO-150	326	221	240	147	25	126	165	120	170	142	5,5	121	229
TD EVO-160	306	221	240	157	25	126	165	120	170	142	5,5	121	229
TD EVO-200	346	238	263	197	28	137	190	124	211	161	5,5	161	253
TD EVO-250	390	289	306	247	40	159	230	155	231	194	7	182	295
TD EVO-315	485	353	371	312	40	192	278	188	317	242	7	206	358



### PERFORMANCE CURVES

- $q_v$ : Airflow in  $m^3/h$ .
- $p_{sf}$ : Static pressure in Pa.
- Dry air at 20°C and 760 mmHg.
- Performance data in accordance with ISO 5801 and AMCA 210-99 Standards.
- SFP: Specific fan power in  $W/m^3/s$  (blue curves).

HS: High speed  
MS: Medium speed  
LS: Low speed

Air performance certified by AMCA is for installation type D – Ducted inlet, Ducted outlet.  
Performance ratings do not include the effects of appurtenances (accessories).

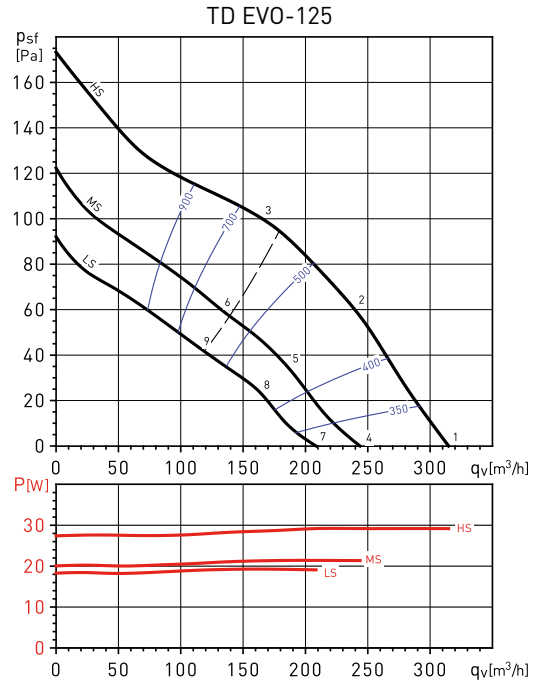
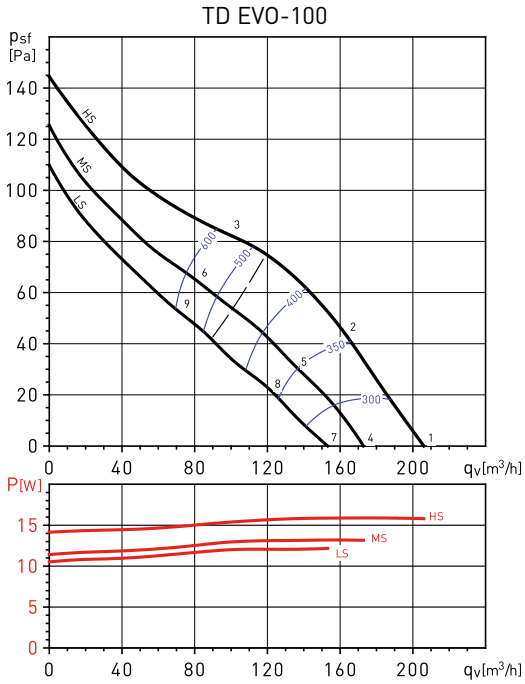

### Sound data

Working point	1	2	3	4	5	6	7	8	9
LwiA	60	60	61	57	57	58	54	54	55

Sound performance certified by AMCA. Values shown are for inlet LwiA sound power levels for installation type D: ducted inlet, ducted outlet. Ratings include the effects of duct end correction.

The following sound data is a complementary data taken from S&P sound laboratory according ISO 13347-3, this data is not licensed by AMCA International.

### Sound power level spectrums in dB(A)

Working point		63	125	250	500	1000	2000	4000	8000	LwA
1	Inlet	23	25	42	47	49	45	38	27	52
	Outlet	21	26	51	45	49	46	38	25	54
	Break-Out	22	19	33	27	35	36	29	21	40
2	Inlet	24	25	40	47	48	44	39	27	52
	Outlet	23	27	44	45	48	44	38	25	52
	Break-Out	24	20	32	27	35	35	30	21	40
3	Inlet	24	35	45	48	48	42	36	27	53
	Outlet	23	38	48	45	47	42	36	25	53
	Break-Out	23	29	36	27	34	33	28	20	41
4	Inlet	19	21	39	43	45	41	34	23	49
	Outlet	18	23	48	41	46	42	34	22	51
	Break-Out	19	16	30	23	31	33	26	17	37
5	Inlet	21	22	37	44	45	40	35	24	49
	Outlet	20	23	41	41	44	41	35	21	48
	Break-Out	20	16	28	23	31	31	27	18	36
6	Inlet	21	32	43	45	45	39	33	24	50
	Outlet	21	35	45	43	45	39	33	22	50
	Break-Out	21	26	34	25	31	31	25	18	38
7	Inlet	17	18	36	41	43	39	32	21	46
	Outlet	15	20	45	38	43	39	31	19	48
	Break-Out	16	13	27	20	29	30	23	15	34
8	Inlet	18	19	34	41	42	37	32	21	46
	Outlet	17	20	38	38	41	38	32	18	45
	Break-Out	17	13	25	20	28	28	24	15	33
9	Inlet	19	30	40	43	43	37	31	22	47
	Outlet	18	33	43	40	42	36	31	20	47
	Break-Out	18	24	31	22	29	28	22	15	36

### Sound data

Working point	1	2	3	4	5	6	7	8	9
LwiA	65	63	64	59	57	59	56	54	56

Sound performance certified by AMCA. Values shown are for inlet LwiA sound power levels for installation type D: ducted inlet, ducted outlet. Ratings include the effects of duct end correction.

The following sound data is a complementary data taken from S&P sound laboratory according ISO 13347-3, this data is not licensed by AMCA International.

### Sound power level spectrums in dB(A)

Working point		63	125	250	500	1000	2000	4000	8000	LwA
1	Inlet	24	29	47	53	53	51	45	32	58
	Outlet	24	32	51	54	55	50	44	32	59
	Break-Out	20	19	31	36	45	43	36	25	48
2	Inlet	24	27	47	52	52	48	43	30	56
	Outlet	24	30	48	51	55	47	40	27	57
	Break-Out	20	18	31	34	44	41	34	22	46
3	Inlet	26	34	47	52	53	51	45	45	57
	Outlet	27	37	49	53	55	51	45	42	59
	Break-Out	21	25	31	34	44	43	36	37	48
4	Inlet	18	23	41	47	47	45	39	26	52
	Outlet	18	25	45	48	48	44	38	26	53
	Break-Out	14	13	25	30	39	37	30	18	42
5	Inlet	18	21	40	45	46	42	36	23	50
	Outlet	18	23	42	45	48	40	34	21	51
	Break-Out	14	11	25	28	37	34	28	15	40
6	Inlet	20	29	41	46	47	45	40	39	52
	Outlet	21	32	43	47	49	45	39	36	53
	Break-Out	16	19	25	29	39	37	31	31	42
7	Inlet	15	20	38	44	44	42	36	23	49
	Outlet	15	23	42	45	46	41	35	23	50
	Break-Out	11	10	22	27	36	34	27	16	39
8	Inlet	15	18	38	42	43	39	34	20	47
	Outlet	15	21	39	42	46	37	31	18	48
	Break-Out	11	9	22	25	35	31	25	12	37
9	Inlet	17	26	38	43	44	42	37	36	49
	Outlet	18	29	41	45	46	42	36	33	50
	Break-Out	13	16	22	26	36	34	28	29	39

# IN-LINE MIXED FLOW DUCT FANS TD-EVO Series



## PERFORMANCE CURVES

- $q_v$ : Airflow in  $m^3/h$ .
- $p_{st}$ : Static pressure in Pa.
- Dry air at 20°C and 760 mmHg.
- Performance data in accordance with ISO 5801 and AMCA 210-99 Standards.
- SFP: Specific fan power in  $W/m^3/s$  (blue curves).

HS: High speed  
MS: Medium speed  
LS: Low speed

Air performance certified by AMCA is for installation type D – Ducted inlet, Ducted outlet.  
Performance ratings do not include the effects of appurtenances (accessories).

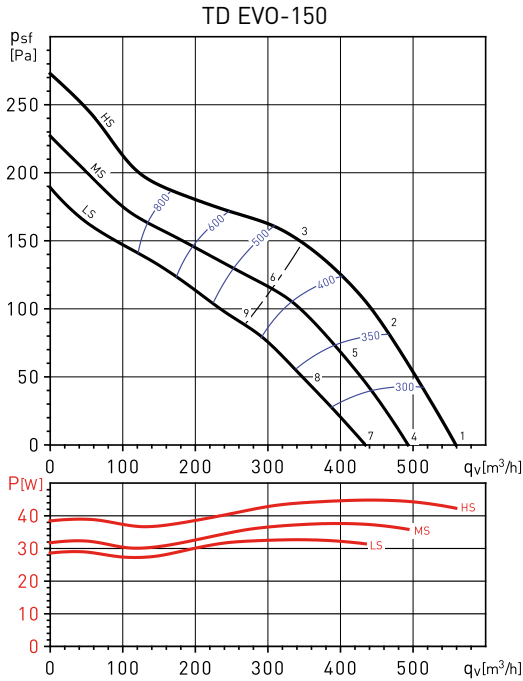

### Sound data

Working point	1	2	3	4	5	6	7	8	9
LwiA	68	69	70	70	67	68	67	64	65

Sound performance certified by AMCA. Values shown are for inlet LwiA sound power levels for installation type D: ducted inlet, ducted outlet. Ratings include the effects of duct end correction.

The following sound data is a complementary data taken from S&P sound laboratory according ISO 13347-3, this data is not licensed by AMCA International.

### Sound power level spectrums in dB(A)

Working point		63	125	250	500	1000	2000	4000	8000	LwA
1	Inlet	34	36	51	59	62	63	58	46	67
	Outlet	35	35	52	60	62	62	59	47	67
	Break-Out	34	29	36	41	49	53	42	32	55
2	Inlet	35	36	51	56	60	61	54	42	65
	Outlet	32	36	51	57	62	60	54	42	65
	Break-Out	35	29	36	37	47	50	39	28	53
3	Inlet	37	40	55	60	60	60	53	42	65
	Outlet	34	38	51	61	63	58	52	42	66
	Break-Out	37	33	40	42	47	49	37	29	52
4	Inlet	31	34	49	56	59	60	56	44	65
	Outlet	33	32	49	58	60	59	57	44	65
	Break-Out	31	27	33	38	46	50	40	30	52
5	Inlet	33	33	49	53	57	58	52	39	62
	Outlet	29	33	48	55	59	57	52	39	63
	Break-Out	33	26	33	35	44	48	36	26	50
6	Inlet	34	37	52	57	57	57	50	40	63
	Outlet	31	35	48	59	60	55	50	39	64
	Break-Out	34	30	37	39	44	47	34	26	50
7	Inlet	29	31	46	54	57	58	53	41	62
	Outlet	30	30	47	55	57	56	54	42	62
	Break-Out	29	24	31	35	44	47	37	27	50
8	Inlet	30	30	46	50	55	55	49	36	59
	Outlet	26	30	45	52	56	54	49	36	60
	Break-Out	30	23	30	32	41	45	33	23	47
9	Inlet	31	34	50	54	54	54	48	37	60
	Outlet	29	33	45	56	57	53	47	36	61
	Break-Out	31	27	34	36	41	44	32	23	47

## TD EVO-160

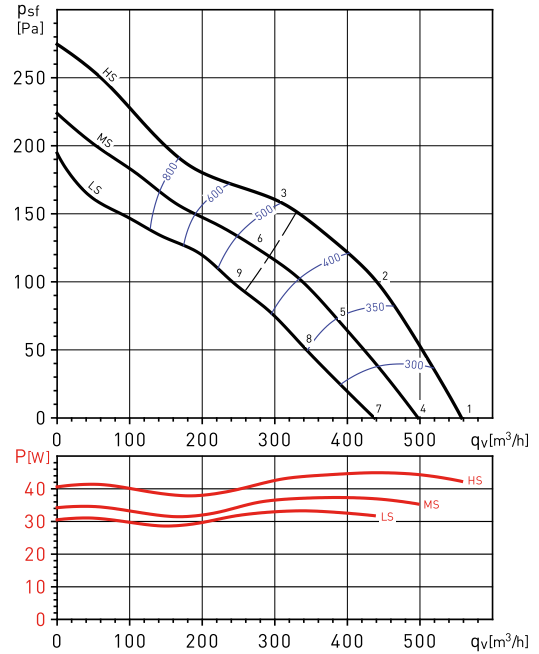

### Sound data

Working point	1	2	3	4	5	6	7	8	9
LwiA	72	69	71	70	67	68	67	63	66

Sound performance certified by AMCA. Values shown are for inlet LwiA sound power levels for installation type D: ducted inlet, ducted outlet. Ratings include the effects of duct end correction.

The following sound data is a complementary data taken from S&P sound laboratory according ISO 13347-3, this data is not licensed by AMCA International.

### Sound power level spectrums in dB(A)

Working point		63	125	250	500	1000	2000	4000	8000	LwA
1	Inlet	29	35	51	57	62	64	59	46	67
	Outlet	29	36	51	60	64	63	60	47	68
	Break-Out	25	33	40	37	49	54	43	31	55
2	Inlet	29	35	50	54	60	60	54	42	64
	Outlet	28	36	49	57	63	60	54	42	66
	Break-Out	25	32	39	33	47	50	39	27	52
3	Inlet	31	39	57	59	60	61	54	42	66
	Outlet	30	38	56	62	64	59	52	41	67
	Break-Out	26	36	45	39	47	51	38	27	53
4	Inlet	27	33	49	55	59	61	56	44	65
	Outlet	27	34	49	57	61	60	57	44	66
	Break-Out	23	30	37	35	46	51	41	28	53
5	Inlet	26	32	47	51	57	58	51	40	62
	Outlet	26	33	46	54	60	57	51	39	63
	Break-Out	22	29	36	31	44	47	36	24	50
6	Inlet	28	36	54	57	58	58	51	40	63
	Outlet	27	36	53	60	62	57	50	39	65
	Break-Out	24	34	43	36	45	48	36	25	51
7	Inlet	24	30	46	52	57	59	53	41	62
	Outlet	24	31	46	55	59	58	55	42	63
	Break-Out	20	28	34	32	43	48	38	26	50
8	Inlet	23	29	44	48	54	54	48	36	58
	Outlet	22	30	43	51	57	54	48	36	60
	Break-Out	20	26	33	27	41	44	33	21	47
9	Inlet	26	34	52	54	55	56	49	38	61
	Outlet	25	34	51	57	59	54	47	36	63
	Break-Out	22	31	40	34	42	46	33	22	49

# IN-LINE MIXED FLOW DUCT FANS TD-EVO Series



## PERFORMANCE CURVES

- $q_v$ : Airflow in  $m^3/h$ .
- $p_{st}$ : Static pressure in Pa.
- Dry air at 20°C and 760 mmHg.
- Performance data in accordance with ISO 5801 and AMCA 210-99 Standards.
- SFP: Specific fan power in  $W/m^3/s$  (blue curves).

HS: High speed  
MS: Medium speed  
LS: Low speed

Air performance certified by AMCA is for installation type D – Ducted inlet, Ducted outlet.  
Performance ratings do not include the effects of appurtenances (accessories).

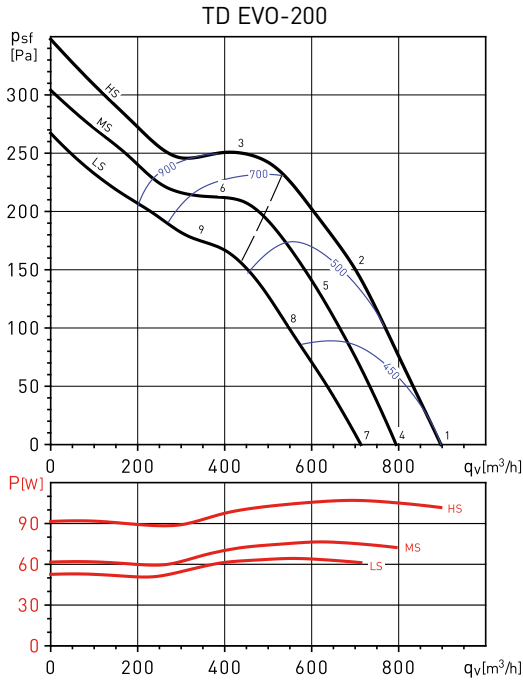

### Sound data

Working point	1	2	3	4	5	6	7	8	9
LwiA	74	72	73	72	70	72	70	67	70

Sound performance certified by AMCA. Values shown are for inlet LwiA sound power levels for installation type D: ducted inlet, ducted outlet. Ratings include the effects of duct end correction.

The following sound data is a complementary data taken from S&P sound laboratory according ISO 13347-3, this data is not licensed by AMCA International.

### Sound power level spectrums in dB(A)

Working point		63	125	250	500	1000	2000	4000	8000	LwA
1	Inlet	32	43	54	61	64	66	63	51	70
	Outlet	30	44	52	61	64	67	64	51	71
	Break-Out	23	43	40	39	51	52	43	30	56
2	Inlet	30	40	51	59	63	63	59	51	68
	Outlet	29	41	55	61	63	63	58	47	68
	Break-Out	21	40	37	37	50	50	39	30	53
3	Inlet	37	53	60	63	64	63	58	50	69
	Outlet	36	60	59	65	63	62	55	48	70
	Break-Out	28	53	46	41	51	50	38	29	57
4	Inlet	30	41	52	59	62	64	61	49	68
	Outlet	28	42	50	59	62	65	62	49	69
	Break-Out	21	41	38	37	49	50	41	28	54
5	Inlet	28	38	49	57	61	61	57	49	66
	Outlet	27	39	53	59	61	61	55	45	66
	Break-Out	20	38	35	35	48	47	37	28	51
6	Inlet	35	51	58	61	63	61	56	48	68
	Outlet	34	58	58	63	61	61	53	46	68
	Break-Out	26	51	44	40	50	48	36	27	55
7	Inlet	27	39	49	56	60	61	59	47	66
	Outlet	26	39	47	57	60	63	60	47	67
	Break-Out	20	39	35	34	47	48	39	26	51
8	Inlet	25	35	46	54	58	58	54	46	63
	Outlet	24	36	50	56	58	58	53	43	63
	Break-Out	20	35	32	32	45	45	34	25	49
9	Inlet	33	49	56	59	61	59	54	46	66
	Outlet	32	56	56	61	59	59	52	44	66
	Break-Out	24	49	42	38	48	46	34	26	53

## TD EVO-250

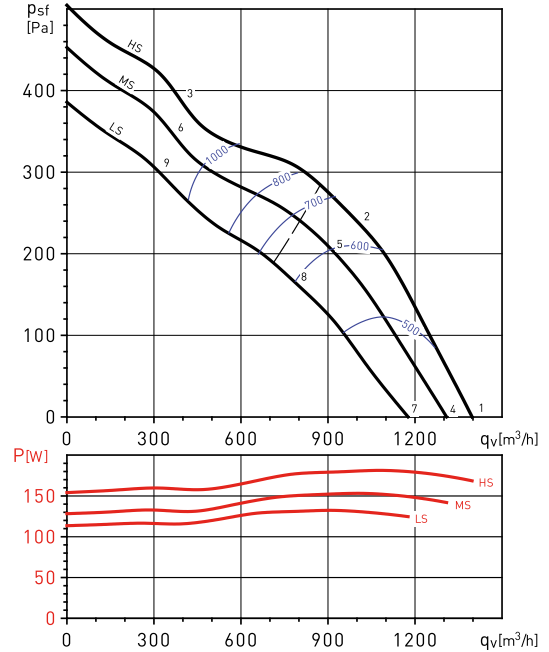

### Sound data

Working point	1	2	3	4	5	6	7	8	9
LwiA	79	76	77	77	74	75	75	71	73

Sound performance certified by AMCA. Values shown are for inlet LwiA sound power levels for installation type D: ducted inlet, ducted outlet. Ratings include the effects of duct end correction.

The following sound data is a complementary data taken from S&P sound laboratory according ISO 13347-3, this data is not licensed by AMCA International.

### Sound power level spectrums in dB(A)

Working point		63	125	250	500	1000	2000	4000	8000	LwA
1	Inlet	37	47	57	65	71	72	67	59	76
	Outlet	36	49	62	66	72	73	68	59	77
	Break-Out	32	39	41	47	57	57	42	34	60
2	Inlet	32	45	56	63	69	68	61	55	73
	Outlet	35	46	59	65	70	69	61	52	73
	Break-Out	27	38	41	45	55	53	37	29	58
3	Inlet	39	57	65	67	69	67	62	56	74
	Outlet	41	59	67	67	68	66	60	54	74
	Break-Out	34	50	49	49	55	52	38	30	59
4	Inlet	36	45	56	64	70	70	65	58	74
	Outlet	34	47	60	64	71	72	67	58	76
	Break-Out	30	38	40	46	56	55	41	32	59
5	Inlet	30	44	55	61	67	66	59	53	71
	Outlet	33	44	57	63	68	67	60	50	72
	Break-Out	25	36	39	43	53	52	35	27	56
6	Inlet	38	56	63	66	67	66	60	55	72
	Outlet	40	58	66	65	67	65	59	53	72
	Break-Out	33	49	48	47	53	51	36	29	57
7	Inlet	34	43	53	62	67	68	63	56	72
	Outlet	32	45	58	62	69	70	65	56	73
	Break-Out	28	36	38	44	53	53	39	30	57
8	Inlet	28	41	52	58	64	64	57	50	68
	Outlet	30	42	55	60	65	65	57	48	69
	Break-Out	22	34	36	40	50	49	33	25	53
9	Inlet	36	54	62	64	66	64	59	53	70
	Outlet	38	56	64	63	65	63	57	51	71
	Break-Out	31	47	46	46	52	49	35	27	56

## PERFORMANCE CURVES

- $q_v$ : Airflow in  $m^3/h$ .
- $p_{st}$ : Static pressure in Pa.
- Dry air at 20°C and 760 mmHg.
- Performance data in accordance with ISO 5801 and AMCA 210-99 Standards.
- SFP: Specific fan power in  $W/m^3/s$  (blue curves).

HS: High speed  
MS: Medium speed  
LS: Low speed

Air performance certified by AMCA is for installation type D – Ducted inlet, Ducted outlet.  
Performance ratings do not include the effects of appurtenances (accessories).

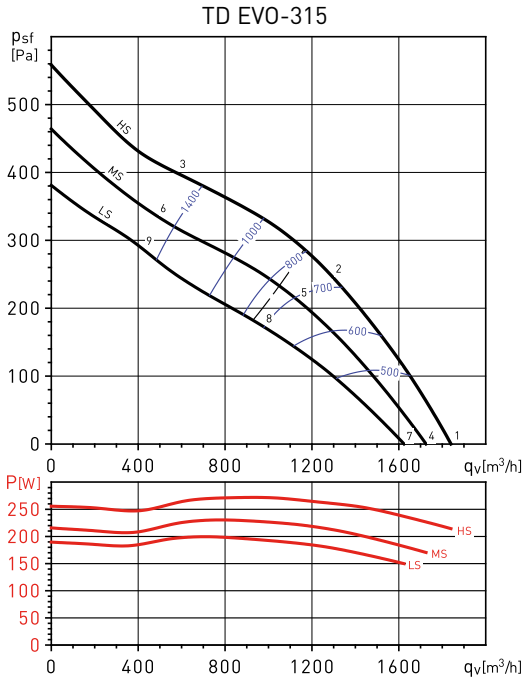

### Sound data

Working point	1	2	3	4	5	6	7	8	9
LwiA	79	80	81	78	78	80	77	76	78

Sound performance certified by AMCA. Values shown are for inlet LwiA sound power levels for installation type D: ducted inlet, ducted outlet. Ratings include the effects of duct end correction.

The following sound data is a complementary data taken from S&P sound laboratory according ISO 13347-3, this data is not licensed by AMCA International.

### Sound power level spectrums in dB(A)

Working point		63	125	250	500	1000	2000	4000	8000	LwA
1	Inlet	34	57	63	68	72	68	68	55	76
	Outlet	34	55	60	71	74	69	68	56	77
	Break-Out	20	42	41	50	56	52	45	31	59
2	Inlet	33	64	66	70	72	70	65	57	77
	Outlet	35	52	64	67	72	69	62	55	75
	Break-Out	20	49	45	52	56	54	42	32	60
3	Inlet	46	62	72	72	73	71	64	57	78
	Outlet	51	65	69	70	71	71	62	55	77
	Break-Out	20	47	50	55	57	55	42	32	61
4	Inlet	33	56	62	67	71	67	67	54	75
	Outlet	34	54	60	70	74	69	68	56	77
	Break-Out	20	41	41	50	56	51	44	30	58
5	Inlet	32	62	65	69	71	69	63	55	75
	Outlet	33	50	62	65	70	68	60	53	74
	Break-Out	20	48	43	51	55	53	41	31	59
6	Inlet	45	61	70	71	71	69	63	55	77
	Outlet	50	64	68	68	70	69	61	54	75
	Break-Out	20	46	49	53	56	53	41	31	60
7	Inlet	32	55	61	66	70	66	66	53	74
	Outlet	32	53	59	69	72	67	67	55	76
	Break-Out	20	40	40	49	54	50	43	29	57
8	Inlet	29	60	62	67	68	67	61	53	73
	Outlet	31	48	60	63	68	66	58	51	71
	Break-Out	20	45	41	49	53	51	39	29	56
9	Inlet	42	59	68	69	69	67	61	53	75
	Outlet	48	61	66	66	68	67	59	52	73
	Break-Out	20	44	47	51	54	51	38	29	58



## GENERAL INSTALLATION ACCESSORIES



**MCA**  
**Back-draft shutters** mounted at the outlet of the fans, to prevent external air entry and to limit heat leakage, when the fan are not in use.

Model	Type of TD EVO
MCA-250	TD EVO 100
MCA-350	TD EVO 125
MCA-500/150 S	TD EVO 150
MCA-500/160 S	TD EVO 160
MCA-800	TD EVO 200
MCA-1000	TD EVO 250
MCA-2000	TD EVO 315

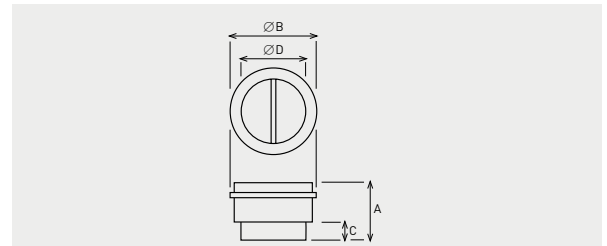

Model	A	Ø B	C	Ø D
MCA-250	107	109	31,5	94,5
MCA-350	107	136	31,5	119,5
MCA-500/150 S	121	163,5	35	147
MCA-500/160 S	121	173,5	35	157
MCA-800	131,5	214	35	197,5
MCA-1000	164	264,5	42	248
MCA-2000	205	330	50	312



**MAR**  
**Rectangular duct adapters** enable TD EVO to be connected to rectangular ducting.

Model	Type of TD EVO	Nominal dim. of ducting LxH
MAR-250	TD EVO 100	224x140
MAR-250-350 S	TD EVO 125	224x140
MAR-500 S	TD EVO 150	280x180
MAR-500/160	TD EVO 160	280x180
MAR-800-1000 S	TD EVO 200	315x200
MAR-1000	TD EVO 250	400x250
MAR-2000	TD EVO 315	500x315

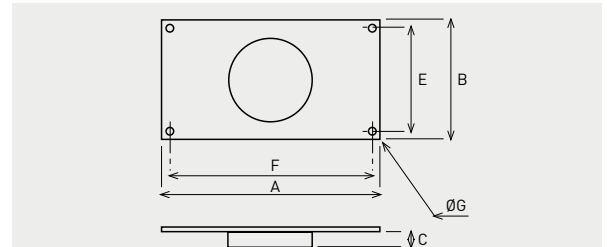

Model	A	B	C	E	F	Ø G
MAR-250	264	180	33,3	160	244	9
MAR-250-350 S	264	180	33,5	160	244	9
MAR-500 S	320	220	37	200	300	9
MAR-500/160	320	220	37	200	300	9
MAR-800-1000 S	355	240	37	220	335	9
MAR-1000	440	290	42	270	420	9
MAR-2000	540	355	52	355	520	9



**MRJ**  
**Grilles** mounted at the inlet or outlet of the fan, to prevent the entry of any foreign objects that could damage the fan.

Model	Type of TD EVO
MRJ-250	TD EVO 100
MRJ-250-350 S	TD EVO 125
MRJ-500 S	TD EVO 150
MRJ-500/160	TD EVO 160
MRJ-800-1000 S	TD EVO 200
MRJ-1000	TD EVO 250
MRJ-2000	TD EVO 315



**MFL-G4**  
Filtration box with G4 grade filter included.



**MFL-F**  
Box in galvanized sheet steel to incorporate filters MFR F5, F6 or F7.



**MBE**  
Electric heater attenuators.



**SIL**  
Circular sound attenuators.



**GSA-M0**  
Flexible aluminium ducting.



**GSI-M0**  
Flexible acoustic ducting.

GENERAL INSTALLATION ACCESSORIES

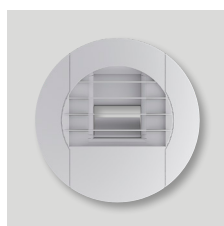

**BEH**  
Circular air valves.



**EC AIR ENTRY**  
Reducer.

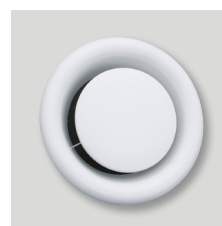

**BOC**  
Circular air valves.



**PER-W**  
Outdoor plastic  
louvre shutters.

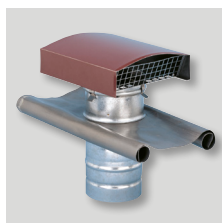

**CT**  
Roof terminal kits.



**GRA**  
Aluminium external  
grilles.



**GRI**  
Internal extract gri-  
lles.

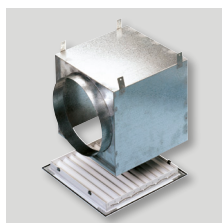

**RP**  
Terminal connectors for  
GRI internal gri-  
lles.



**GCI**  
Interior circular gri-  
lles.

ELECTRICAL ACCESSORIES



**INTER-4P**  
3-speed switch.



**REB**  
Single-phase  
electronic speed  
controller.



**RMB**  
Single-phase  
auto-transformer  
speed controller.



**REB-ECOWATT**  
Remote speed  
control.



**CVF-ECOWATT**  
Remote speed  
control.



**VAPZ**  
Single-phase speed  
controller.



**CONTROL ECOWATT  
AC/4A**  
Control element for  
demand controlled  
ventilation systems.



**CPTA-S/CPTA-E**  
Presence detector.



**AIRSENS**  
Single-phase speed  
controller



**TDP-S/TDP-D/  
TDP-PI**  
Pressure sensor.



**SC02-A/SC02-AD**  
Ambient CO<sub>2</sub> and  
temperature sensor.  
SC02-AD with  
display.  
**SCHT-AD**  
Ambient CO<sub>2</sub>,  
temperature and  
relative humidity  
with display.



**REMP**  
Motorised damper.

**ELECTRICAL ACCESSORIES**



**PULSER**  
Single phase electric  
heater controller.



**TTC-2000 and  
TTC-25**  
Three phase electric  
heater controller.

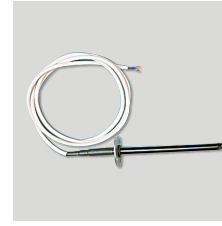

**TG-K**  
Duct temperature  
sensor.