

AS6D37HP

STANDARD MATERIALS AND CONSTRUCTION

FRAME: .081" thick (nominal) extruded aluminum, 6063-T52/T6 alloy. Frame also available in .125" thickness (nominal).

BLADE: .081" thick (nominal) extruded aluminum, 6063-T52/T6 alloy. Blades approximately 4" on centers.

LOUVER FACE: Full width sill, with blades and head contained in jambs.

SCREEN: (When indicated.)

½" flattened aluminum (.051" thick),

-or- ½" sq. mesh, intermediate double-crimped aluminum wire, .063" dia.,

-or- ¾" mesh, .011" dia. aluminum wire, insect screen.

FINISH: Mill

OPTIONS

Finish - Baked Enamel, Kynar, Anodize

NOTES

1. Nominal deductions shall be made to the opening size given.
2. Approximate shipping weight is 4.0 lbs./sq.ft.

LOUVER SIZES

Min Panel	Max Single Panel
12"W x 12"H	60"W x 96"H

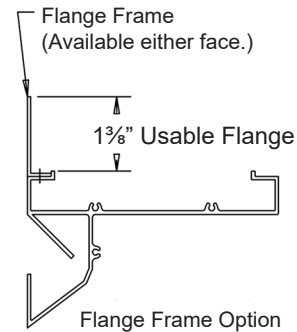
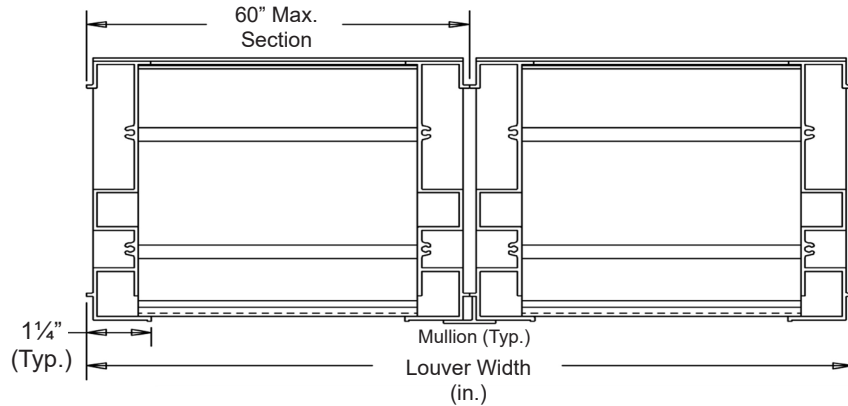
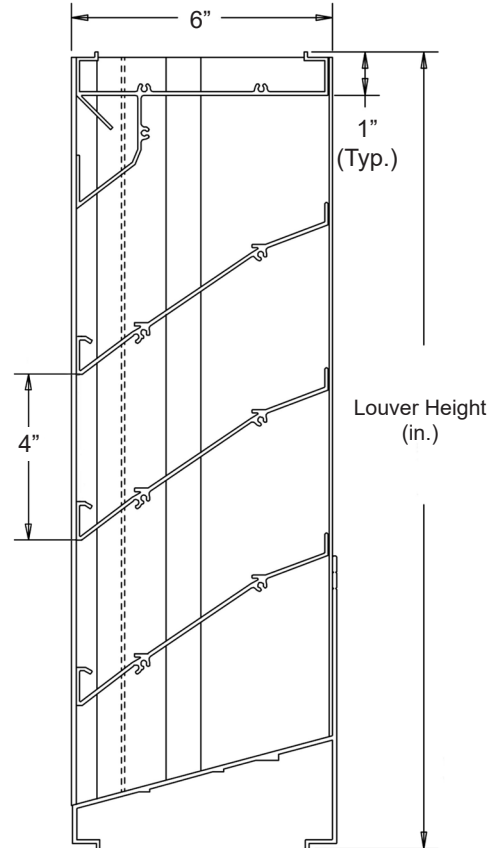

In the interest of product development, Airline Louvers reserves the right to make changes without notice.

											
Item #	Qty	Width	Height	Width	Height	Mullion	Type	Location			
		Opening Size		Louver Size			Screens				Union Made
Arch. / Eng. :						EDR:		ECN:		Job:	
Contractor:											
Project:						Date:		DWN:		DWG:	

AS6D37HP

PERFORMANCE DATA

Pressure Drop: .13 in. w.g. at 1000 fpm (intake)

Free Area: 10.06 sq.ft. = 63% for 48"W x 48"H sample tested in accordance with AMCA Standard 500-L.

Beginning Point of Water Penetration: 908 fpm

Ratings do not include effects of a screen.

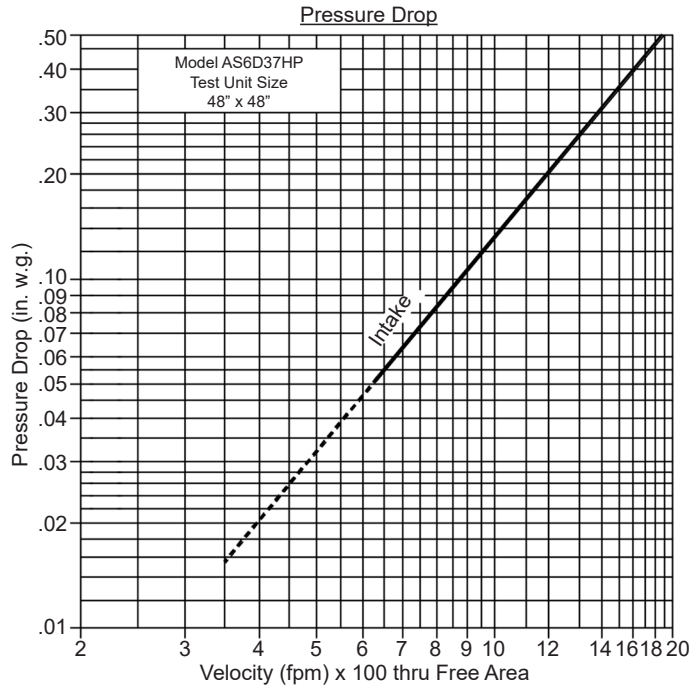

Intake air converted to standard air density.
Tested to AMCA Standard 500-L, Figure 5.5.

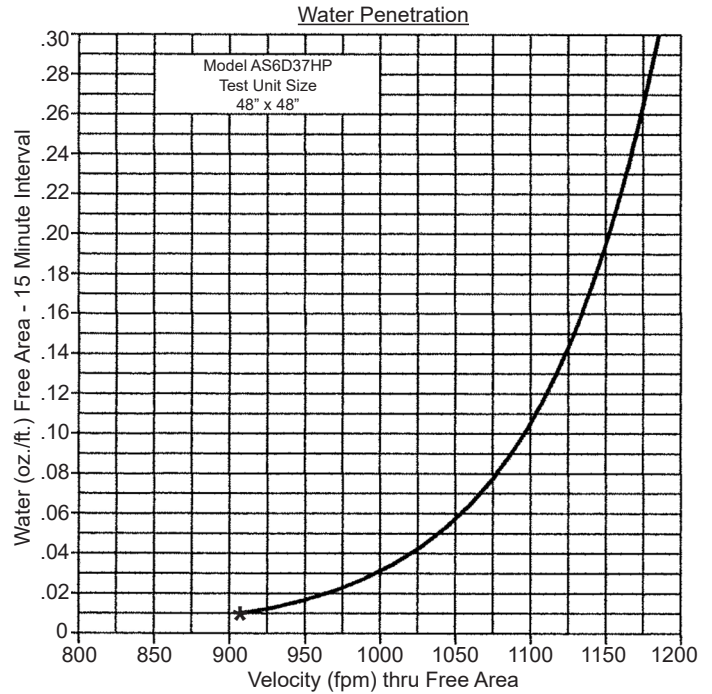

908 (FPM) Beginning Point of Water Penetration

Free Area (sq.ft.)

		Width (in.)								
		12"	18"	24"	30"	36"	42"	48"	54"	60"
Height (in.)	12"	.29	.47	.66	.84	1.03	1.21	1.39	1.58	1.76
	24"	.90	1.47	2.04	2.60	3.17	3.74	4.31	4.88	5.45
	36"	1.51	2.46	3.41	4.37	5.32	6.27	7.23	8.18	9.13
	48"	2.10	3.43	4.76	6.09	7.42	8.75	10.06	11.41	12.73
	60"	2.68	4.38	6.07	7.76	9.46	11.15	12.84	14.54	16.23
	72"	3.29	5.37	7.45	9.52	11.60	13.68	15.76	17.84	19.92
	84"	3.90	6.36	8.82	11.29	13.75	16.21	18.67	21.14	23.60
	96"	4.51	7.35	10.20	13.05	15.90	18.74	21.59	24.44	27.28



Airline Louvers certifies that the Model AS6D37HP shown herein is licensed to bear the AMCA Seal. The ratings shown are based on tests and procedures performed in accordance with AMCA Publication 511 and comply with the requirements of the AMCA Certified Ratings Program. The AMCA Certified Ratings Seal applies to Water Penetration and Air Performance ratings only.