

MODEL EAV-66

Miami-Dade HVHZ Louver • 6" Deep • Chevron Blades • Stationary • Vertical • Extruded Aluminum

Standard Materials and Construction

- FRAME:** Head and Sill: .125" thick (nominal) extruded aluminum alloy 6063-T52/T6.
Jamb: .080" thick (nominal) extruded aluminum alloy 6063-T52/T6.
- BLADE:** .081" thick (nominal) extruded aluminum, 6063-T52/T6 alloy.
- SILL PAN:** .060" thick (nominal) formed aluminum.
- SCREEN:** (Located on interior.)
½" removable expanded aluminum bird screen.
- FINISH:** Mill

Withstands pressures up to ±150 PSF.

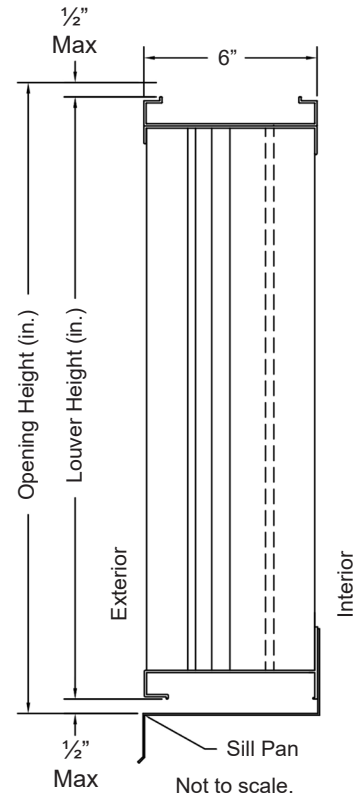

Test Methods

Miami-Dade County Florida Test Protocols:

- TAS-100(A)-95
- TAS (PA) 201
- TAS (PA) 202
- TAS (PA) 203

Options

Finish - Baked Enamel, Kynar, Anodize
Concealed Mullion

Notes

1. Nominal deductions will be made to the opening size given.
2. Panel width not to exceed 96". Panel height not to exceed 96". Panel square footage not to exceed 32 sq. ft.
3. Unlimited assembly width utilizing standard mullions or optional concealed mullions. Assembly height limited to a single panel. Consult factory for openings greater than 96" high.
4. Approximate shipping weight is 7.0 lbs./sq.ft.

Louver Sizes

Min Panel	Max Single Panel
18"W x 18"H	See Note 2

Windload requirements may limit panel sizes.

Substrates

Qualified substrates are steel, 3000-PSI concrete, or southern pine.

This louver has been tested to **AMCA Standard 540 for Wind Borne Debris Impact Resistance** and **AMCA Standard 550 for High Velocity Wind Driven Rain**.
See Page 2 for seal and listing information.

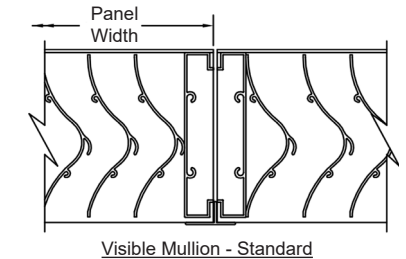
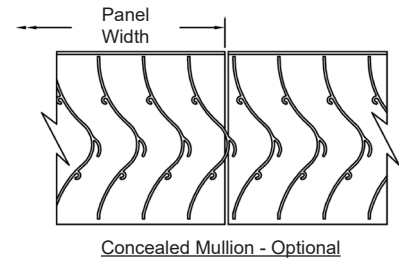
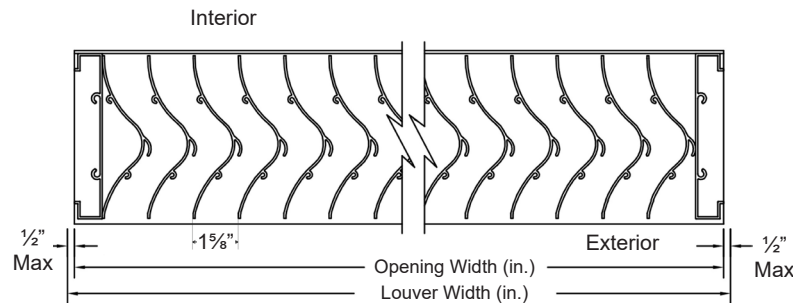

Item #	Qty	Width	Height	Width	Height	Mullion	Type	Location	Union Made
		Opening Size		Louver Size			Screens		
Arch. / Eng.:						EDR:	ECN:	Job:	
Contractor:									
Project:						Date:	DWN:	DWG:	



Visit our Miami-Dade Listing Page for the latest NOA information:
<https://goo.gl/DJ5Utm>

In the interest of product development, Arrow United reserves the right to make changes without notice.
450 Riverside Dr • Wyalusing PA, 18853 • Phone 570-746-1888 • Fax 570-746-9286
AUI-09-01-06

Performance Data

Pressure Drop: .164 in. w.g. (40.6 Pa) at 1250 fpm (6.35 m/s)
 Free Area: 7.85 sq.ft. (0.729 m²) = 49.1% for 48"W x 48"H (1.22m x 1.22m) sample tested in accordance with AMCA Standard 500-L.
 Missile Impact: "Enhanced Protection" Rated at 55 mph (80 m/s) per ASTM 1886/1996.

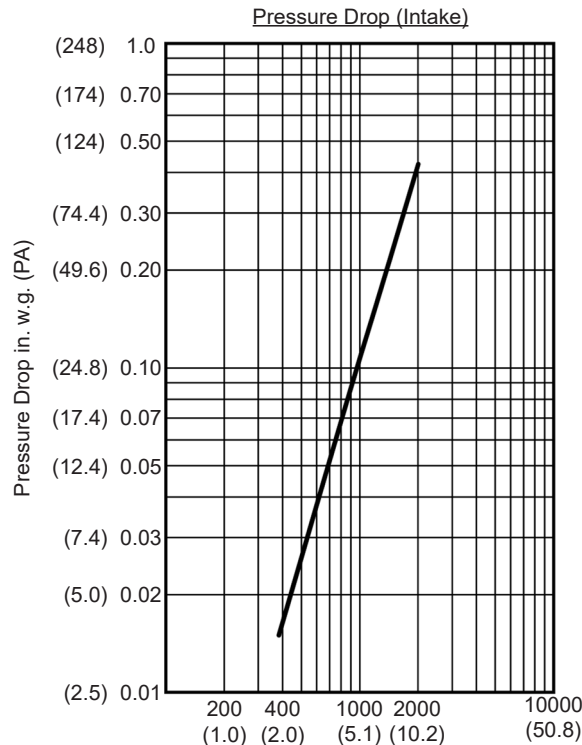

		Free Area sq.ft. (sq. meters)							
		Width in. (mm)							
		18" (457)	24" (610)	36" (914)	48" (1219)	60" (1524)	72" (1829)	84" (2134)	96" (2438)
Height in. (mm)	18" (457)	0.88 (0.082)	1.22 (0.113)	1.95 (0.181)	2.64 (0.245)	3.38 (0.314)	4.11 (0.381)	4.80 (0.446)	5.55 (0.516)
	24" (610)	1.23 (0.114)	1.59 (0.148)	2.61 (0.242)	3.63 (0.337)	4.55 (0.423)	5.56 (0.516)	6.48 (0.602)	7.50 (0.697)
	36" (914)	1.93 (0.179)	2.52 (0.234)	4.13 (0.384)	5.74 (0.533)	7.19 (0.668)	8.80 (0.817)	10.25 (0.952)	11.86 (1.102)
	48" (1219)	2.63 (0.244)	3.44 (0.320)	5.65 (0.525)	7.85 (0.729)	9.83 (0.913)	12.04 (1.118)	14.02 (1.302)	16.22 (1.507)
	60" (1524)	3.33 (0.309)	4.37 (0.406)	7.16 (0.665)	9.96 (0.925)	12.48 (1.159)	15.27 (1.418)	17.79 (1.653)	20.59 (1.913)
	72" (1829)	4.03 (0.374)	5.30 (0.492)	8.68 (0.806)	12.07 (1.121)	15.12 (1.405)	18.51 (1.719)	21.56 (2.003)	24.95 (2.318)
	84" (2134)	4.73 (0.439)	6.22 (0.578)	10.20 (0.948)	14.18 (1.317)	17.77 (1.651)	21.75 (2.020)	25.33 (2.353)	29.31 (2.723)
	96" (2438)	5.43 (0.504)	7.15 (0.664)	11.72 (1.089)	16.29 (1.513)	20.41 (1.896)	24.98 (2.320)	29.11 (2.704)	33.68 (3.129)

Wind-Driven Rain Penetration Classes		Discharge Loss Coefficient Classes	
Class	Effectiveness	Class	Coefficient
A	100% to 99%	1	0.4 and above
B	98.9% to 95%	2	0.3 to 0.399
C	94.9% to 80%	3	0.2 to 0.299
D	Below 80%	4	0.199 and below

Wind Driven Rain Performance - 29 mph (46.7 kph) with 3 in/h (76 mm/h)

Water Penetration Class	Effectiveness Ratio Percentage	Coefficient of Discharge Class	Core Velocity FPM (m/s)	Ventilation Airflow CFM (cm/min)	Free Area Velocity FPM (m/s)
Class A	100.0%	Class I	980 (5)	10,546 (299)	2,170 (11)

Wind Driven Rain Performance - 50 mph (80.5 kph) with 8 in/h (203 mm/h)

Water Penetration Class	Effectiveness Ratio Percentage	Coefficient of Discharge Class	Core Velocity FPM (m/s)	Ventilation Airflow CFM (cm/min)	Free Area Velocity FPM (m/s)
Class A	99.2%	Class I	784 (4)	8,440 (239)	1,736 (8.8)
Class A	99.1%	Class I	877 (4.5)	9,445 (267)	1,943 (9.9)
Class A	99.1%	Class I	982 (5)	10,578 (300)	2,176 (11)

Wind driven rain performance tests based on 1 m x 1 m (39.37" x 39.37") Louver with 7.85 sq.ft. (0.729 m²) free area.



HIGH VELOCITY RAIN RESISTANT WITH BLADES FULLY OPEN AND IMPACT RESISTANT LOUVER Basic Protection Level D
See www.AMCA.org for all certified or listed products

This label does not signify AMCA airflow performance certification.

Arrow United Industries certifies that the Model EAV-66 shown herein is approved to bear the AMCA Listing Label. The ratings shown are based on tests and procedures performed in accordance with AMCA Publications and comply with the requirements of the AMCA Listing Label Program.

The AMCA Listing Label applies to High Velocity Rain Resistant and Wind Borne Debris Impact Resistant Louvers.



Arrow United Industries certifies that the Model EAV-66 shown herein is licensed to bear the AMCA seal. The ratings shown are based on tests and procedures performed in accordance with AMCA Publication 511 and comply with the requirements of the AMCA Certified Ratings Program. The AMCA Certified Ratings Seal applies to Air Performance and Wind Driven Rain Ratings only.



Visit our Miami-Dade Listing Page for the latest NOA information:

<https://goo.gl/DJ5UtM>

450 Riverside Dr • Wyalusing PA, 18853 • Phone 570-746-1888 • Fax 570-746-9286

MODEL EAV-66

Miami-Dade HVHZ Louver • 6" Deep • Chevron Blades • Stationary • Vertical • Extruded Aluminum

Standard Boxed Frame Louver Model EAV-66

Installation Instructions

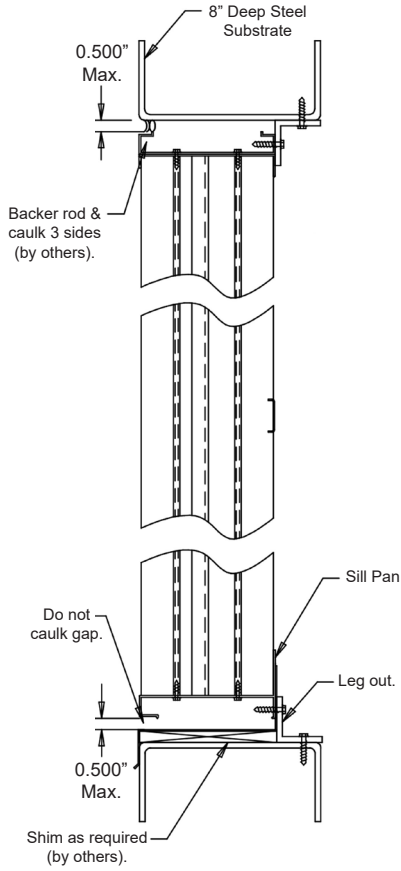

Standard Boxed Frame with Steel Substrate

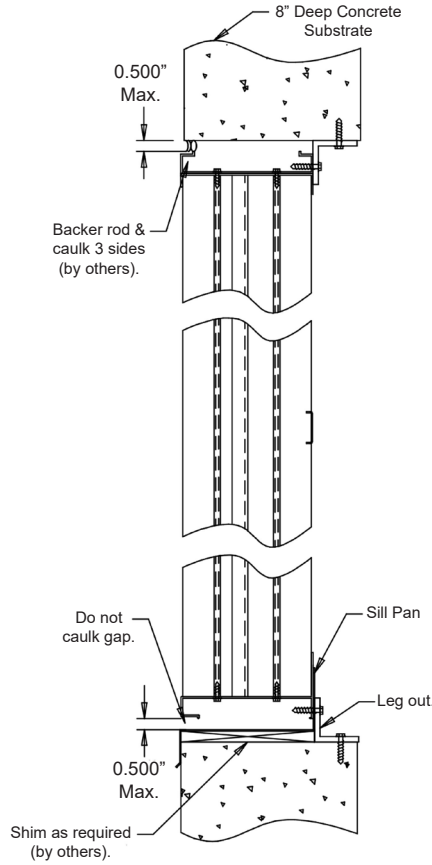

Standard Boxed Frame with Concrete Substrate

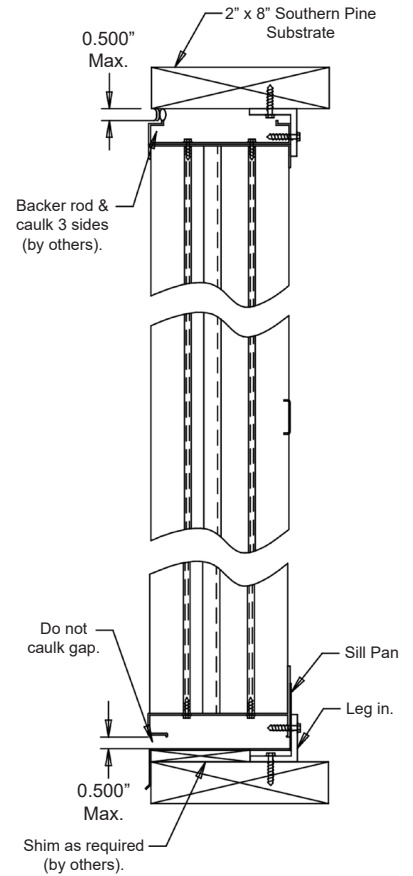

Standard Boxed Frame with Southern Pine Substrate

Notes

1. Mounting angles can be installed with "legs in" or "legs out" for any approved substrate.
2. "Legs out" is the standard construction, "legs in" is optional.
3. The Flanged Sleeve option can be used with any approved substrate.
4. Use shims to obtain uniform clearance between the louver and the louver opening on all sides. Shims are provided by others.
5. Sealant between flanged angle sleeve and the substrate provided by installer.
6. Two mounting angles run the full width of the louver.

MODEL EAV-66

Miami-Dade HVHZ Louver • 6" Deep • Chevron Blades • Stationary • Vertical • Extruded Aluminum

Flanged Frame Louver Model EAV-66

Installation Instructions

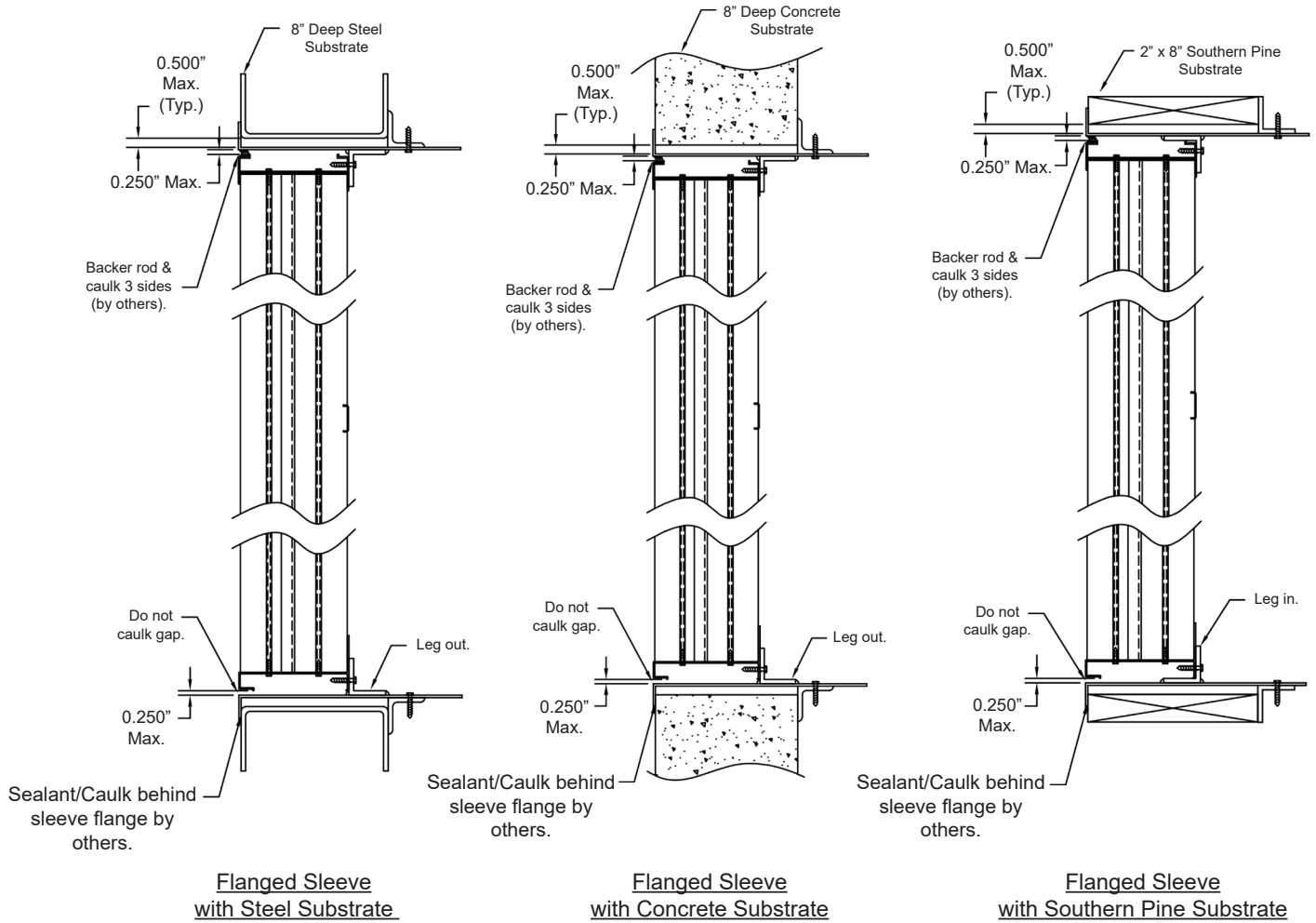

Notes

1. Mounting clip angles can be installed with "legs in" or "legs out" for any approved substrate.
2. "Legs out" is the standard construction, "legs in" is optional.
3. The Flanged Sleeve can be used with any approved substrate.
4. Use shims to obtain uniform clearance between the louver and the louver opening on all sides. Shims are provided by others.
5. Sealant between flanged angle sleeve and the substrate provided by installer.
6. Two mounting angles run the full height and length of louver.

MODEL EAV-66

Miami-Dade HVHZ Louver • 6" Deep • Chevron Blades • Stationary • Vertical • Extruded Aluminum

Flanged Frame Louver Model EAV-66

Installation Instructions

For TAS-100 Approved Model EAV-66 Louver/Damper

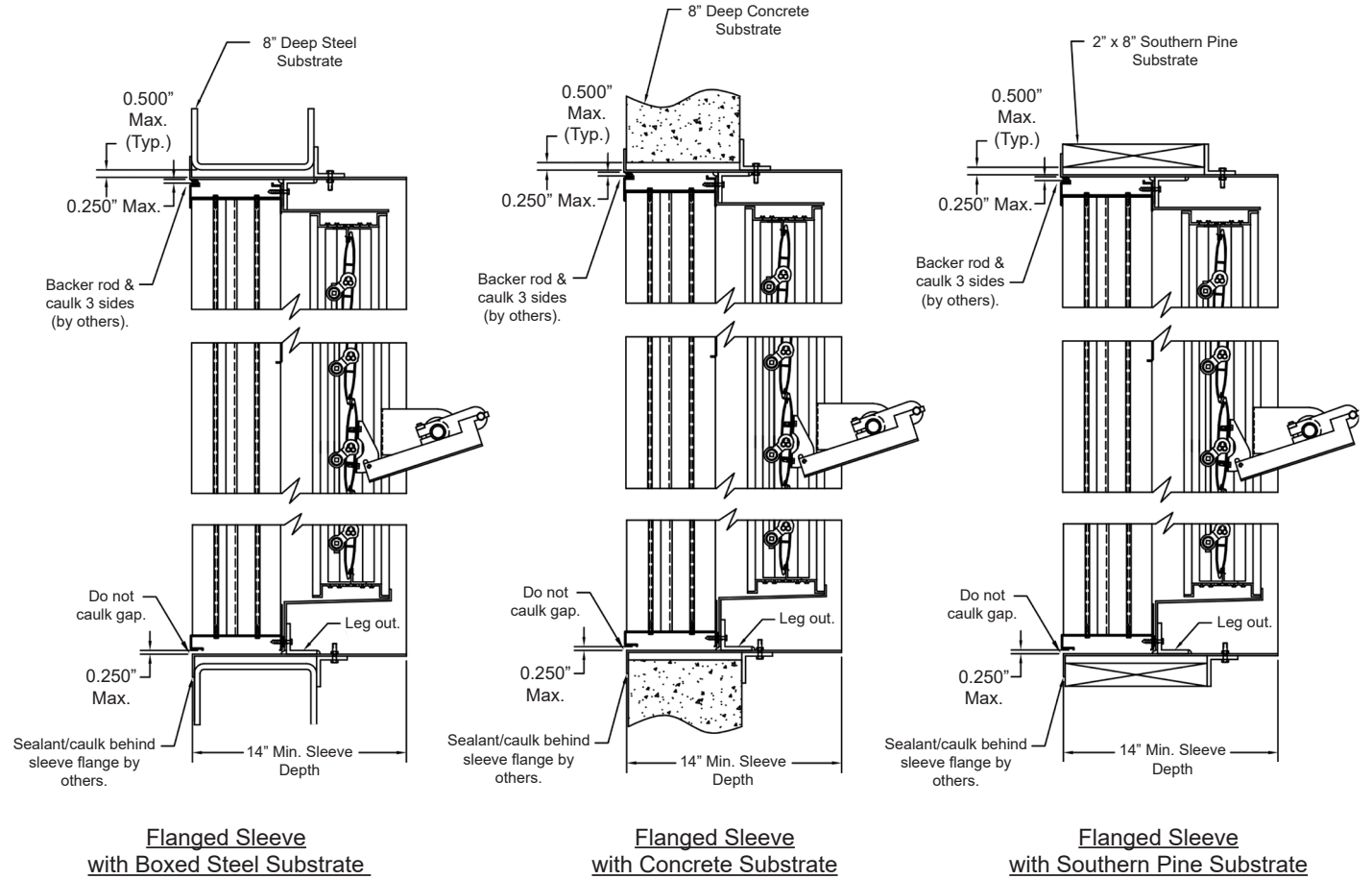

Notes

1. The Flanged Sleeve option can be used with any approved substrate.
2. Use shims to obtain uniform clearance between the louver and the louver opening on all sides. Shims are provided by others.
3. Sealant between flanged angle sleeve and the substrate provided by installer.
4. Two mounting angles run the full width of the louver.