

FRP GENERAL-PURPOSE FUME EXHAUSTERS

- Capacities to 73,000 CFM
- Two wheel choices
- Static pressures to 17"WG
- Temperatures to 250°F.

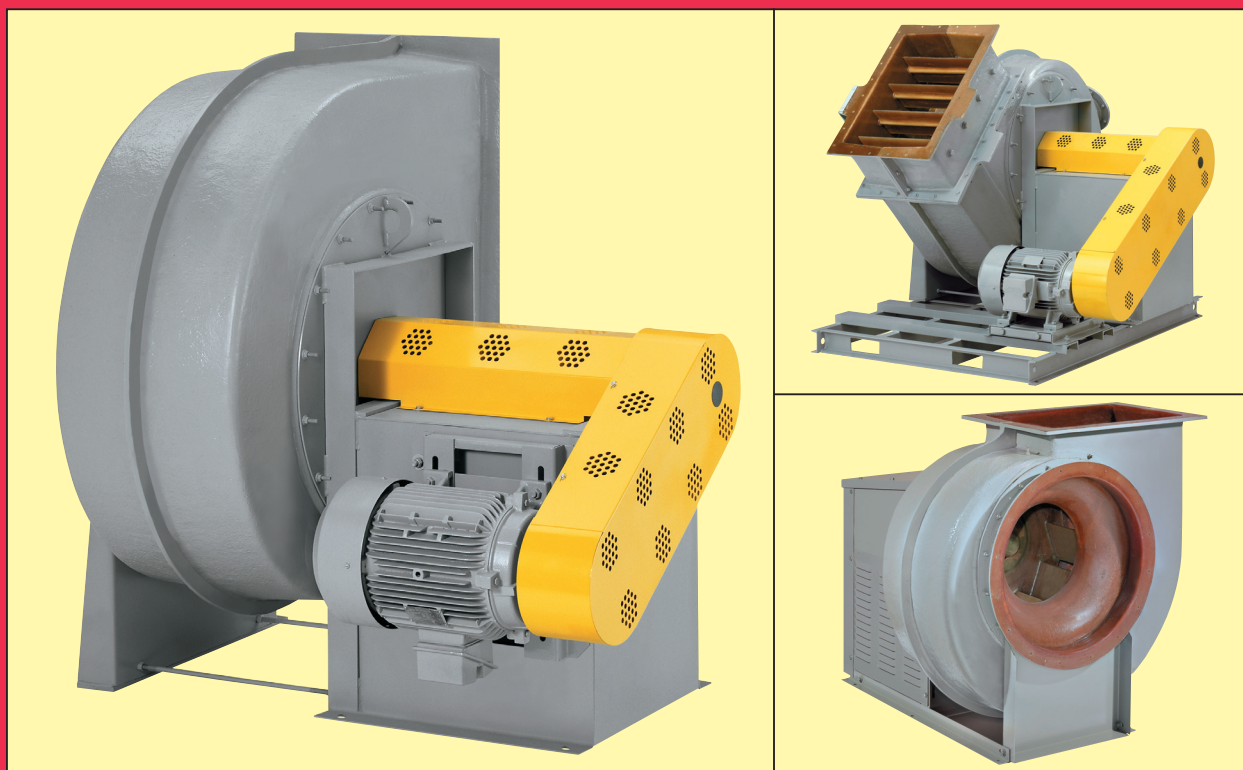

Fiberglass-reinforced-plastic fans for handling corrosive gas streams in a wide variety of process applications...



THE NEW YORK BLOWER COMPANY
7660 Quincy Street
Willowbrook, IL 60527-5530

Visit us on the Web: <http://www.nyb.com>
Phone: (800) 208-7918 Email: nyb@nyb.com

FRP GENERAL-PURPOSE FUME EXHAUSTERS



Arrangement 9 GFE, counterclockwise, Top Horizontal, with outlet flange drilling, and guards.

BACKWARDLY INCLINED WHEELS

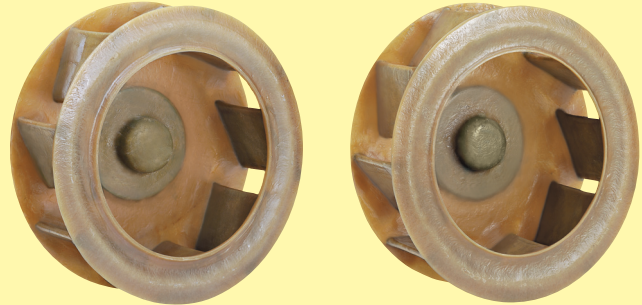

MEDIUM PRESSURE [MP] HIGH PRESSURE [HP]

FRP General-Purpose Fume Exhauster backwardly inclined wheels provide high efficiency and quiet operation with a non-overloading horsepower characteristic. Made of premium-quality, corrosion-resistant vinyl ester resin. Metal hub, shaft, and stainless-steel fasteners are encapsulated in full-thickness FRP.

DESIGN FEATURES

The New York Blower Company's FRP General-Purpose Fume Exhauster [GFE] is designed so that all parts exposed to the airstream are constructed of high-quality corrosion-resistant fiberglass reinforced plastic. The GFE is resistant to attack from most chemicals and is ideally suited to applications in the chemical, pulp and paper, wastewater-treatment, fertilizer, pharmaceutical, and metals industries.

- Ten sizes: 12", 15", 18", 24", 30", 36", 42", 48", 54" and 60" wheel diameters.
- Capacities to 73,000 CFM.
- Static pressures to 17"WG.
- Temperatures to 250°F.
- Choice of arrangements: Sizes 121 and 151 available in Arrangements 1, 8, 9, and 10. Sizes 181 through 361 [medium pressure fans only] available in Arrangement 10. Sizes 181 through 601 available in Arrangements 1, 8, 9, and 9-E. Sizes 361 through 601 also available in Arrangement 9-F.

CONSTRUCTION FEATURES

- Housing is made of premium-quality, corrosion-resistant polyester resin. By using male molds, housing interior surfaces are smooth, improving efficiency and reducing the potential for material build-up.
- Flanged outlet for easy in-duct connection.
- Slip inlet suitable for flexible-sleeve inlet connection.
- All Arrangement 10 fans, and all other arrangements up to Size 301, are rotatable to any of five discharge positions.
- Lifting eyes on all fans for ease of handling.
- Welded steel base is constructed of heavy-gauge components for structural strength and durability. Arrangement 10 base features self-contained motor platform.
- Neoprene gasketing at all bolted FRP joints.
- Fan exterior is coated with gray epoxy enamel.
- Close-fitting, Teflon® shaft-hole closure limits the free exchange of gases through the shaft-hole opening. [Teflon is a registered trademark of DuPont.]
- GFE wheels are dynamically balanced before final assembly. After assembly, all fans are given a final trim balance check at the specified running speed.
- Sizes 181 and larger meet ASTM D 4167 when fan is purchased with surface veil.



AMCA SEAL

The New York Blower Company certifies that the FRP General-Purpose Fume Exhausters shown herein are licensed to bear the AMCA Seal. The ratings shown are based on tests and procedures performed in accordance with AMCA Publication 211 and comply with the requirements of the AMCA Certified Ratings Program.

ACCESSORIES/MODIFICATIONS

- **Parallel-blade outlet damper**—for Sizes 181 and larger for flow control. All airstream parts are constructed of FRP.
- **Flanged outlet drilling**—for ease of direct connection; dimensions shown on page 12.
- **Unitary base**—available with spring or rubber-in-shear [R-I-S] isolators. Isolation rails are available for Arrangement 10 fans without inlet boxes.
- **Flanged inlet**—plain or drilled [see page 12 for drilling pattern].
- **Drain**—threaded FRP drain with PVC plug, 1" npt, at lowest point of housing scroll.
- **Inspection port**—allows examination of fan interior. Located on drive-side half of housing at 2 or 10 o'clock, opposite discharge. Opening is 4" diameter on Sizes 121 and 151, 6" diameter on Sizes 181 and 241, 8" on Sizes 301 through 421, and 12" on Sizes 481 through 601.
- **Positive screw adjustment**—two threaded rods provide easy motor platform/V-belt adjustment. [Arrangement 10 fans only].
- **Arrangement 10 weather cover/belt guard**—provides motor and drive protection, and can be easily removed for inspection and maintenance. Louvered side panels provide ample motor ventilation.
- **Safety equipment**—belt guards and shaft and bearing guards are available for Arrangements 1, 9, 9-E, and 9-F fans, and coupling guards for Arrangement 8 fans.
- **Inlet box** [includes support leg]—for Sizes 181 through 541. Minimizes losses at inlet. See pages 4 and 13 for details.
- **Cleanout door**—provides access for cleaning and inspecting fan interior for Sizes 181 and larger.
- **Shaft seal**—Viton® elements in FRP casing. Type 316 SST sleeve covers shaft for use with seal. Teflon seal and Hastelloy C-276 sleeve available.
[Viton is a registered trademark of DuPont Dow Elastomers.]
- **Surface veil**—for added protection against certain corrosives. Provides compliance to ASTM D 4167 for Sizes 181 and larger.
- **All-vinyl ester airstream**—provides additional protection from certain corrosives.
- **Graphite impregnation**—to control static electricity. The gas-stream surfaces are grounded to the fan base.
- **Narrow-width construction**—to optimize the point of operation. Available on Sizes 181 and larger to 75% of full width on medium pressure fans and 67% on high pressure fans. Maximum safe wheel speed increases as width decreases.



Arrangement 1 GFE, clockwise, Bottom Angular Up, with optional inspection port, unitary base, discharge damper, outlet flange drilling, motor, and guards.

Arrangement 10 GFE, clockwise, Up Blast, with optional weather cover/belt guard.



SAFETY EQUIPMENT

Safety accessories are available from **nyb**, but selection of the appropriate devices is the responsibility of the system-designer who is familiar with the particular installation, or application, and can provide for guards for all exposed moving parts as well as protection from access to high-velocity airstreams. Neither **nyb** nor its sales representatives is in a position to make such a determination. Users and/or installers should read "Recommended Safety Practices for Air Moving Devices" as published by the Air Movement and Control Association International, Arlington Heights, Illinois.

INLET BOXES

FOR FRP GENERAL-PURPOSE FUME EXHAUSTERS

When airflow is turned 90° to enter a fan, there is a loss of fan performance due to eccentric loading of the fan's inlet. Use of **nyb's** aerodynamically designed inlet box reduces the entry loss to a minimum and allows accurate prediction of the loss so it can be included in system calculations. See page 13 for dimensions. Refer to the FRP Fume Exhauster Bulletin 571, pages 4 and 5, or the **nyb** fan-selection program to determine inlet box entry losses.

STANDARD FEATURES

FRP inlet boxes are offered for Sizes 181 through 541 FRP General-Purpose Fume Exhausters. The inlet box is designed to attach to the inlet flange of the fan. A support leg with mounting plate is standard on all inlet boxes. When furnished complete with a unitary base or isolation base, the base must be extended to meet the support leg. The inlet box/support leg assembly is not intended to support additional weight from ductwork or any other system components.

The use of male molds and smooth resin-rich surfaces ensures efficient performance and excellent corrosion resistance.

The resin system is the same high-quality, corrosion-resistant system used in **nyb** FRP General-Purpose Fume Exhauster housings.

FRP inlet boxes are made in two sections, gasketed and bolted together with 316 stainless-steel hardware. Boxes can be fitted with drains.

An epoxy-based coating is applied to the exterior surface to be consistent with the finish on the exterior surface of the fan.

FRP inlet boxes will normally be shipped separately to prevent damage to inlet box or fan.



INLET BOX POSITIONS

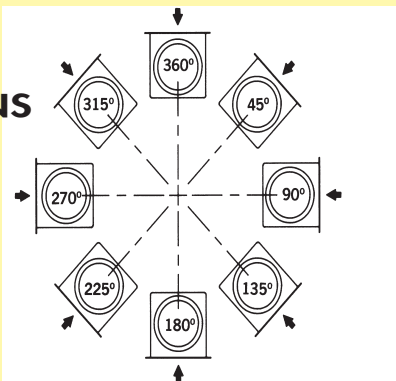

Position of inlet box is determined from drive side of fan.

Inlet-box positions 135°, 180°, and 225° often require special construction to avoid interference with the fan support structure. When other accessories such as unitary base are required, a special layout is necessary.

CHART I CORRECTION FACTORS FOR TEMPERATURE [°F.]	
Temperature	Factor
-50	.77
-25	.82
0	.87
20	.91
40	.94
70	1.00
100	1.06
130	1.11
160	1.17
200	1.25
250	1.34

CHART II CORRECTION FACTORS FOR ALTITUDE [feet above sea level]	
Altitude	Factor
0	1.00
1000	1.04
2000	1.08
3000	1.12
4000	1.16
5000	1.20
6000	1.25
7000	1.30
8000	1.35
9000	1.40
10000	1.45

CHART III MAXIMUM SAFE WHEEL SPEED AT 70°F. [RPM]		
Size	All Arrangements	
	MP	HP
121	3800	—
151	3315	—
181	2900	3570
241	2090	2470
301	1610	1985
361	1360	1680
421	1150	1420
481	975	1200
541	815	1000
601	735	905

CHART IV TEMPERATURE [°F.] SAFE SPEED FACTORS	
Temperature	Factor
70-150	1.00
200	.94
225	.86
250	.73

Note: 250°F. is maximum allowable temperature.

NOTE: If correction factor for both temperature and altitude is required, multiply factors from Chart I and II together: 3000 and 200°F. 1.12 x 1.25 = 1.40 [combined factor].

How to Use Performance Tables

For a given fan size, CFM, and static pressure, performance tables can be used to obtain outlet velocity, wheel RPM, and BHP. If capacities are at conditions other than 70°F., sea level, or standard density [.075 lbs./cu.ft.], correction factors must be applied to static pressure and BHP.

STEPS TO FOLLOW	STEPS	EXAMPLE: Size 121 fan to handle 1600 CFM at 4"WG at 200°F. at sea level.
Determine fan static pressure at standard conditions. If temperature or altitude is involved, correct for air density [see Charts I and II on page 4].	1	Chart I on page 4 shows 1.25 correction factor for 200°F. 4"WG x 1.25 = 5"WG at 70°F.
Select size, RPM, and BHP of fan from capacity tables.	2	Capacity table shows 3484 RPM, 1.9 BHP for Size 121 fan at 1600 CFM at 5"WG at 70°F.
Check the maximum safe speed of the fan shown in Chart III on page 4.	3	Maximum safe speed of Size 121 fan is 3800 RPM at 70°F.
Apply temperature maximum safe speed factors from Chart IV on page 4 to maximum safe speed of fan from Step 3 to determine new maximum safe speed when temperature is involved.	4	Chart IV on page 4 shows .94 correction factor for 200°F. .94 x 3800 RPM = 3572 RPM at 200°F.
Determine actual performance by dividing static pressure and BHP* from Step 2 by the correction factor in Step 1.	5	Actual performance: 1600 CFM at 4"WG at 3484 RPM at 1.52 BHP at 200°F.

*NOTE: Motor should be selected for BHP @ 70°F. to insure proper operation during "cold starts."

PERFORMANCE FOR FRP GENERAL-PURPOSE FUME EXHAUSTERS WITH WHEELS

SIZE 121		MP		Wheel diameter: 12½" Wheel circumference: 3.21'				Inlet diameter: 12½" I.D. Fan outlet area = 0.85 sq. ft.				Maximum BHP = .048 $\left[\frac{\text{RPM}}{1000}\right]^3$									
CFM	OV	1"SP		2"SP		3"SP		4"SP		4½"SP		5"SP		5½"SP		6"SP		6½"SP		7"SP	
		RPM	BHP	RPM	BHP	RPM	BHP	RPM	BHP	RPM	BHP	RPM	BHP	RPM	BHP	RPM	BHP	RPM	BHP	RPM	BHP
800	941	1619	0.64	2068	0.79	2447	0.97	2778	1.17	2950	1.28	3109	1.39								
900	1059	1691	0.66	2126	0.82	2485	1.00	2812	1.21	2963	1.32	3117	1.44	3255	1.56	3406	1.69				
1000	1176	1766	0.69	2192	0.85	2540	1.04	2858	1.26	3006	1.38	3144	1.49	3281	1.62	3415	1.75	3544	1.88	3682	2.03
1100	1294	1848	0.71	2261	0.89	2601	1.09	2903	1.31	3049	1.43	3186	1.55	3323	1.68	3445	1.81	3575	1.95	3700	2.12
1200	1412	1934	0.74	2339	0.93	2667	1.14	2957	1.36	3102	1.49	3228	1.61	3365	1.74	3489	1.88	3608	2.02	3721	2.20
1300	1529	2024	0.77	2412	0.98	2737	1.19	3018	1.42	3153	1.54	3281	1.67	3408	1.81	3533	1.95	3655	2.12	3773	2.32
1400	1647	2111	0.80	2483	1.02	2811	1.25	3086	1.49	3222	1.62	3342	1.75	3471	1.89	3577	2.02	3701	2.23		
1500	1765	2202	0.84	2567	1.07	2883	1.31	3167	1.57	3288	1.70	3410	1.83	3531	1.97	3641	2.14	3758	2.35		
1600	1882	2299	0.88	2653	1.12	2959	1.38	3237	1.65	3360	1.78	3484	1.92	3591	2.07	3704	2.27				
1700	2000	2394	0.92	2742	1.18	3033	1.44	3305	1.73	3438	1.88	3548	2.01	3666	2.21	3773	2.41				
1800	2118	2494	0.97	2825	1.24	3117	1.52	3379	1.81	3506	1.96	3626	2.16	3739	2.36						

SIZE 151		MP		Wheel diameter: 15" Wheel circumference: 3.93'				Inlet diameter: 15½" I.D. Fan outlet area = 1.29 sq. ft.				Maximum BHP = .140 $\left[\frac{\text{RPM}}{1000}\right]^3$									
CFM	OV	1"SP		2"SP		3"SP		4"SP		5"SP		6"SP		6½"SP		7"SP		7½"SP		8"SP	
		RPM	BHP	RPM	BHP	RPM	BHP	RPM	BHP	RPM	BHP	RPM	BHP	RPM	BHP	RPM	BHP	RPM	BHP	RPM	BHP
1000	775	1309	0.72	1701	0.96	2009	1.24	2274	1.54	2512	1.88	2734	2.31	2842	2.57	2949	2.83	3053	3.11	3153	3.40
1100	853	1353	0.74	1738	1.00	2039	1.28	2303	1.60	2532	1.94	2749	2.41	2863	2.70	2960	2.95	3064	3.24	3154	3.50
1200	930	1400	0.77	1779	1.04	2068	1.33	2330	1.65	2566	2.02	2780	2.53	2877	2.79	2982	3.08	3067	3.33	3167	3.64
1300	1008	1452	0.81	1811	1.07	2111	1.39	2367	1.73	2598	2.12	2809	2.65	2907	2.92	2996	3.18	3091	3.47	3191	3.79
1400	1085	1509	0.84	1848	1.11	2152	1.45	2402	1.80	2629	2.22	2838	2.76	2929	3.02	3026	3.31	3114	3.59	3207	3.90
1500	1163	1566	0.88	1888	1.16	2191	1.51	2436	1.86	2659	2.33	2866	2.87	2964	3.16	3055	3.44	3152	3.76	3239	4.06
1600	1240	1624	0.93	1932	1.21	2222	1.56	2477	1.94	2698	2.45	2894	2.99	2998	3.30	3084	3.57	3174	3.88	3271	4.22
1700	1318	1680	0.97	1983	1.27	2258	1.62	2516	2.03	2736	2.58	2933	3.14	3031	3.44	3124	3.75	3210	4.05	3301	4.38
1800	1395	1738	1.02	2033	1.34	2293	1.68	2547	2.12	2772	2.70	2970	3.28	3063	3.59	3151	3.89	3245	4.22		
1900	1473	1795	1.07	2090	1.41	2340	1.76	2584	2.23	2808	2.82	3006	3.43	3105	3.76	3190	4.06	3279	4.39		
2000	1550	1853	1.13	2146	1.49	2385	1.84	2621	2.34	2844	2.94	3051	3.60	3146	3.93	3227	4.23	3312	4.55		

Performance certified is for installation Type B: Free inlet, Ducted outlet. Power rating (BHP) does not include transmission losses. Performance ratings do not include the effects of appurtenances (accessories).

PERFORMANCE FOR FRP GENERAL-PURPOSE FUME EXHAUSTERS WITH **MP** WHEELS

SIZE 421		MP		Wheel diameter: 42" Wheel circumference: 11.0'								Inlet diameter: 44" I.D. Fan outlet area = 10.15 sq. ft.				Maximum BHP = 30.2 $\left[\frac{\text{RPM}}{1000}\right]^3$					
CFM	OV	1"SP		2"SP		3"SP		4"SP		5"SP		6"SP		6½"SP		7"SP		7½"SP		8"SP	
		RPM	BHP	RPM	BHP	RPM	BHP	RPM	BHP	RPM	BHP	RPM	BHP	RPM	BHP	RPM	BHP	RPM	BHP	RPM	BHP
16000	1576	523	4.04	619	6.77	710	9.76	798	13.2	885	17.3	964	21.6	1003	23.9	1040	26.3				
17200	1695	548	4.57	636	7.39	724	10.6	808	14.0	890	18.1	968	22.5	1008	25.0	1042	27.2				
18400	1813	572	5.14	657	8.15	740	11.4	820	15.0	896	18.9	972	23.3	1009	25.7	1045	28.2	1079	30.6		
19600	1931	597	5.76	679	9.00	756	12.3	834	16.1	907	20.0	979	24.4	1014	26.7	1048	29.1	1084	31.8	1114	34.2
20800	2049	624	6.47	703	9.90	775	13.4	850	17.2	920	21.2	986	25.4	1023	28.0	1055	30.3	1090	33.0	1122	35.6
22000	2167	651	7.27	727	10.9	795	14.5	867	18.5	932	22.5	999	26.9	1031	29.2	1062	31.5	1095	34.1	1126	36.7
23200	2286	678	8.10	752	11.9	817	15.7	883	19.7	949	24.0	1012	28.4	1043	30.7	1072	33.0	1104	35.6	1133	38.1
24400	2404	706	9.02	776	13.0	839	16.9	900	21.0	966	25.6	1026	30.1	1057	32.5	1085	34.8	1116	37.4	1144	39.9
25600	2522	734	10.0	801	14.1	863	18.3	922	22.5	981	27.0	1043	32.0	1070	34.2	1098	36.5	1127	39.2		
26800	2640	761	11.1	825	15.3	888	19.8	944	24.2	999	28.6	1057	33.5	1086	36.1	1113	38.5	1142	41.2		
28000	2759	790	12.3	852	16.6	912	21.3	966	25.9	1020	30.6	1075	35.6	1104	38.2	1130	40.8				

SIZE 481		MP		Wheel diameter: 48" Wheel circumference: 12.6'								Inlet diameter: 50" I.D. Fan outlet area = 13.27 sq. ft.				Maximum BHP = 58.9 $\left[\frac{\text{RPM}}{1000}\right]^3$					
CFM	OV	1"SP		2"SP		3"SP		4"SP		5"SP		5½"SP		6"SP		6½"SP		7"SP		7½"SP	
		RPM	BHP	RPM	BHP	RPM	BHP	RPM	BHP	RPM	BHP	RPM	BHP	RPM	BHP	RPM	BHP	RPM	BHP	RPM	BHP
20000	1507	446	4.88	533	8.38	616	12.2	696	16.8	773	22.1										
21400	1613	464	5.46	546	9.10	626	13.1	700	17.5	775	22.8	810	25.6	847	28.8						
22800	1718	484	6.10	561	9.91	637	14.1	709	18.6	781	23.8	813	26.5	848	29.6	879	32.5	913	35.9		
24200	1824	503	6.79	576	10.7	650	15.1	719	19.8	785	24.8	819	27.7	849	30.4	882	33.5	914	36.8		
25600	1929	523	7.52	594	11.7	662	16.1	729	20.9	793	26.0	825	28.9	857	31.8	888	34.9	918	38.1	947	41.2
27000	2035	544	8.37	614	12.8	676	17.3	742	22.4	805	27.7	833	30.3	864	33.2	894	36.3	923	39.4	953	42.9
28400	2140	565	9.25	632	13.9	692	18.6	755	23.8	814	29.0	844	31.9	871	34.6	899	37.7	927	40.7	956	44.1
29800	2246	586	10.2	651	15.1	709	20.0	767	25.2	827	30.8	854	33.6	883	36.6	910	39.7	934	42.4	962	45.8
31200	2351	608	11.3	670	16.3	726	21.4	781	26.7	839	32.6	866	35.4	894	38.5	918	41.3	944	44.4	971	47.8
32600	2457	629	12.4	689	17.6	745	23.0	796	28.3	851	34.3	877	37.2	905	40.4	931	43.6	957	46.8		
34000	2562	651	13.6	708	19.0	764	24.7	812	30.1	865	36.2	891	39.2	915	42.2	941	45.5	966	48.7		

SIZE 541		MP		Wheel diameter: 54¼" Wheel circumference: 14.2'								Inlet diameter: 56" I.D. Fan outlet area = 16.92 sq. ft.				Maximum BHP = 108 $\left[\frac{\text{RPM}}{1000}\right]^3$					
CFM	OV	1"SP		2"SP		3"SP		4"SP		4½"SP		5"SP		5½"SP		6"SP		6½"SP		7"SP	
		RPM	BHP	RPM	BHP	RPM	BHP	RPM	BHP	RPM	BHP	RPM	BHP	RPM	BHP	RPM	BHP	RPM	BHP	RPM	BHP
24000	1418	379	5.52	462	9.92	539	14.8	612	20.5	648	23.7	683	27.0	714	30.3						
26000	1537	397	6.32	474	10.8	546	15.9	616	21.6	650	24.7	684	28.2	717	31.6						
28000	1655	416	7.18	488	11.9	557	17.2	623	22.9	656	26.2	686	29.3	719	33.0	748	36.6	777	40.3		
30000	1773	436	8.17	503	13.1	570	18.7	632	24.6	662	27.7	690	30.8	721	34.4	752	38.2	779	41.7	808	45.8
32000	1891	455	9.21	519	14.2	582	20.1	641	26.2	670	29.4	699	32.7	728	36.3	755	39.7	783	43.6	810	47.6
34000	2009	476	10.4	536	15.6	596	21.7	654	28.1	681	31.4	707	34.6	735	38.3	761	41.7	787	45.5		
36000	2128	496	11.7	555	17.2	610	23.3	665	29.9	692	33.4	719	37.0	744	40.5	771	44.3	794	47.8		
38000	2246	517	13.0	573	18.8	625	25.0	679	32.1	704	35.5	731	39.3	755	42.9	781	46.8	803	50.4		
40000	2364	538	14.5	593	20.7	643	27.1	693	34.1	718	37.7	742	41.4	767	45.5	790	49.2	814	53.3		
42000	2482	559	16.1	612	22.7	660	29.1	708	36.3	732	40.2	756	44.1	779	48.0	801	51.9				
44000	2600	581	17.8	632	24.7	678	31.4	724	38.8	746	42.5	770	46.6	792	50.8	814	54.9				

SIZE 601		MP		Wheel diameter: 60" Wheel circumference: 15.7'								Inlet diameter: 62" I.D. Fan outlet area = 20.7 sq. ft.				Maximum BHP = 179 $\left[\frac{\text{RPM}}{1000}\right]^3$					
CFM	OV	1"SP		2"SP		3"SP		4"SP		4½"SP		5"SP		5½"SP		6"SP		6½"SP		7"SP	
		RPM	BHP	RPM	BHP	RPM	BHP	RPM	BHP	RPM	BHP	RPM	BHP	RPM	BHP	RPM	BHP	RPM	BHP	RPM	BHP
29000	1401	341	6.69	416	12.0	486	18.0	555	25.3	585	29.1										
31500	1522	358	7.67	427	13.1	493	19.4	557	26.6	588	30.5	617	34.5	647	38.9	676	43.6	701	48.0		
34000	1643	375	8.74	440	14.4	502	20.9	562	28.1	593	32.2	620	36.1	650	40.7	677	45.2	703	49.9		
36500	1763	393	9.93	454	15.9	514	22.7	570	29.9	599	34.1	625	38.0	653	42.5	678	46.9	706	51.9	729	56.4
39000	1884	411	11.2	470	17.5	525	24.4	580	32.2	605	35.9	631	40.2	658	44.7	682	49.0	708	53.9	733	58.9
41500	2005	430	12.7	486	19.3	538	26.4	590	34.3	616	38.5	640	42.5	665	47.2	688	51.5	713	56.4		
44000	2126	449	14.3	503	21.3	552	28.5	602	36.6	626	40.9	649	45.1	674	49.9	696	54.3	720	59.3		
46500	2246	468	16.0	520	23.4	566	30.8	614	39.1	638	43.7	660	48.0	682	52.5	706	57.5	726	62.0		
49000	2367	488	17.8	538	25.7	582	33.4	627	41.8	649	46.2	671	50.8	694	55.8	715	60.5				
51500	2488	508	19.9	555	27.9	600	36.3	641	44.7	663	49.4	684	54.2	705	59.0	726	63.9				
54000	2609	527	22.0	573	30.5	616	39.1	656	47.9	676	52.5	695	57.1	716	62.1						

Performance certified is for installation Type B: Free inlet, Ducted outlet. Power rating (BHP) does not include transmission losses. Performance ratings do not include the effects of appurtenances (accessories).

PERFORMANCE FOR FRP GENERAL-PURPOSE FUME EXHAUSTERS WITH **HP** WHEELS

SIZE 421		HP		Wheel diameter: 42" Wheel circumference: 11.0'				Inlet diameter: 44" I.D. Fan outlet area = 8.99 sq. ft.				Maximum BHP = 22.8 $\left[\frac{\text{RPM}}{1000}\right]^3$									
CFM	OV	2"SP		4"SP		5"SP		6"SP		7"SP		8"SP		9"SP		10"SP		11"SP		12"SP	
		RPM	BHP	RPM	BHP	RPM	BHP	RPM	BHP	RPM	BHP	RPM	BHP	RPM	BHP	RPM	BHP	RPM	BHP	RPM	BHP
14000	1557	653	6.02	830	11.7	908	14.7	981	17.9	1052	21.4	1118	25.0	1187	29.0						
15200	1691	676	6.71	845	12.6	922	15.9	994	19.3	1061	22.7	1127	26.4	1190	30.4	1249	34.3				
16400	1824	700	7.42	862	13.6	938	17.0	1006	20.5	1073	24.2	1135	27.9	1194	31.7	1253	35.9	1313	40.3	1372	45.1
17600	1958	725	8.23	882	14.7	953	18.2	1021	21.9	1084	25.6	1147	29.6	1207	33.8	1264	37.9	1320	42.3	1375	46.8
18800	2091	753	9.16	904	15.9	972	19.5	1038	23.4	1099	27.2	1159	31.3	1216	35.4	1274	39.9	1327	44.2	1378	48.6
20000	2225	781	10.2	926	17.2	994	21.0	1055	24.8	1116	29.0	1174	33.1	1233	37.7	1284	41.8	1339	46.5	1388	51.0
21200	2358	810	11.2	951	18.6	1014	22.5	1073	26.4	1133	30.7	1192	35.2	1245	39.5	1298	44.0	1350	48.8	1402	53.7
22400	2492	839	12.4	974	20.0	1036	24.0	1097	28.4	1152	32.6	1209	37.2	1260	41.6	1316	46.6	1367	51.5	1416	56.5
23600	2625	869	13.7	998	21.5	1059	25.8	1117	30.1	1174	34.7	1226	39.2	1279	44.0	1329	48.7	1382	54.1		
24800	2759	898	14.9	1024	23.2	1085	27.7	1141	32.2	1194	36.7	1245	41.4	1297	46.3	1345	51.1	1397	56.6		
26000	2892	926	16.2	1051	25.0	1109	29.6	1165	34.3	1217	39.0	1268	43.8	1315	48.6	1365	53.9	1411	59.0		

SIZE 481		HP		Wheel diameter: 48" Wheel circumference: 12.6'				Inlet diameter: 50" I.D. Fan outlet area = 11.75 sq. ft.				Maximum BHP = 44.4 $\left[\frac{\text{RPM}}{1000}\right]^3$									
CFM	OV	2"SP		4"SP		5"SP		6"SP		7"SP		8"SP		9"SP		10"SP		10 1/2"SP		11"SP	
		RPM	BHP	RPM	BHP	RPM	BHP	RPM	BHP	RPM	BHP	RPM	BHP	RPM	BHP	RPM	BHP	RPM	BHP	RPM	BHP
17000	1447	554	7.14	714	14.2	786	18.1	851	22.1	918	26.8										
18400	1566	571	7.86	727	15.3	796	19.4	860	23.6	922	28.2	980	32.8	1035	37.7	1091	43.0				
19800	1685	590	8.68	739	16.4	804	20.5	868	25.0	927	29.5	985	34.4	1041	39.6	1093	44.7	1121	47.7	1144	50.2
21200	1804	611	9.62	753	17.6	818	22.0	879	26.6	935	31.1	990	36.0	1047	41.5	1096	46.5	1122	49.3	1149	52.4
22600	1923	631	10.6	768	18.8	831	23.4	890	28.1	946	33.0	999	37.9	1053	43.4	1103	48.8	1128	51.6	1153	54.6
24000	2043	652	11.6	784	20.2	846	25.0	902	29.8	957	34.8	1011	40.1	1062	45.6	1110	51.1	1134	53.8	1158	56.8
25400	2162	672	12.7	802	21.7	860	26.5	917	31.7	970	36.8	1022	42.3	1072	47.8	1117	53.2	1144	56.5	1167	59.5
26800	2281	692	13.7	819	23.2	878	28.3	932	33.5	986	39.1	1033	44.3	1084	50.4	1128	55.9	1154	59.2	1176	62.2
28200	2400	714	15.0	837	24.8	893	29.9	948	35.5	998	41.0	1046	46.6	1096	52.8	1143	59.0	1164	61.8	1185	64.8
29600	2519	736	16.2	858	26.7	912	32.0	963	37.5	1015	43.5	1063	49.3	1108	55.2	1153	61.4	1177	64.8	1198	67.9
31000	2638	758	17.6	877	28.5	930	34.0	981	39.7	1029	45.5	1075	51.5	1122	58.0	1166	64.3	1186	67.2		

SIZE 541		HP		Wheel diameter: 54 1/4" Wheel circumference: 14.2'				Inlet diameter: 56" I.D. Fan outlet area = 14.95 sq. ft.				Maximum BHP = 81.9 $\left[\frac{\text{RPM}}{1000}\right]^3$									
CFM	OV	2"SP		3"SP		4"SP		5"SP		6"SP		7"SP		8"SP		9"SP		9 1/2"SP		10"SP	
		RPM	BHP	RPM	BHP	RPM	BHP	RPM	BHP	RPM	BHP	RPM	BHP	RPM	BHP	RPM	BHP	RPM	BHP	RPM	BHP
22000	1472	494	9.34	567	13.7	634	18.4	695	23.3	756	28.7	811	34.3	866	40.5						
24000	1605	511	10.4	583	15.1	647	20.0	704	25.0	760	30.4	815	36.2	869	42.6	917	48.8	941	52.1		
26000	1739	530	11.6	598	16.5	660	21.7	718	27.1	771	32.6	822	38.4	873	44.7	921	51.3	943	54.4		
28000	1873	549	12.9	613	17.9	675	23.4	730	29.0	783	35.0	832	41.0	880	47.2	929	54.3	950	57.3	971	60.7
30000	2007	569	14.3	632	19.6	690	25.3	744	31.1	795	37.3	844	43.8	890	50.1	937	57.2	956	60.2	980	64.2
32000	2140	590	15.9	649	21.3	707	27.3	759	33.4	808	39.8	856	46.4	902	53.4	944	60.0	966	63.7	989	67.6
34000	2274	613	17.6	669	23.3	722	29.3	775	35.9	823	42.5	869	49.3	914	56.5	957	63.8	979	67.6	997	70.9
36000	2408	635	19.4	690	25.5	740	31.6	790	38.3	840	45.5	885	52.6	929	60.0	970	67.5	991	71.3		
38000	2542	658	21.4	711	27.8	760	34.2	809	41.2	856	48.4	900	55.7	942	63.4	982	71.0				
40000	2676	680	23.4	732	30.2	780	37.0	825	43.8	871	51.2	916	59.3	958	67.1	997	75.0				
42000	2809	702	25.6	755	32.9	800	39.7	845	47.0	890	54.8	932	62.7	973	70.8						

SIZE 601		HP		Wheel diameter: 60" Wheel circumference: 15.7'				Inlet diameter: 62" I.D. Fan outlet area = 18.38 sq. ft.				Maximum BHP = 135 $\left[\frac{\text{RPM}}{1000}\right]^3$									
CFM	OV	2"SP		3"SP		4"SP		5"SP		6"SP		7"SP		8"SP		9"SP		9 1/2"SP		10"SP	
		RPM	BHP	RPM	BHP	RPM	BHP	RPM	BHP	RPM	BHP	RPM	BHP	RPM	BHP	RPM	BHP	RPM	BHP	RPM	BHP
27000	1469	447	11.5	513	16.8	574	22.6	630	28.6	681	34.9	734	42.2	782	49.5	828	57.1				
29500	1605	463	12.8	528	18.6	584	24.5	639	30.9	690	37.5	739	44.8	785	52.1	829	59.7				
32000	1741	479	14.2	542	20.3	598	26.7	650	33.3	698	40.1	744	47.2	790	55.0	834	63.0	854	66.9	875	71.1
34500	1877	498	15.9	557	22.2	612	29.0	662	35.9	707	42.8	754	50.6	797	58.3	839	66.3	861	70.9	881	75.0
37000	2013	517	17.7	573	24.3	626	31.4	675	38.6	721	46.3	763	53.7	808	62.2	847	70.2	868	74.7	887	78.8
39500	2149	537	19.8	590	26.4	640	33.7	689	41.6	734	49.5	775	57.2	817	65.8	855	73.9	875	78.5	896	83.3
42000	2285	557	21.9	608	28.9	656	36.5	703	44.4	746	52.6	788	61.1	829	69.9	868	78.9	884	82.8	904	87.7
44500	2421	578	24.3	627	31.7	674	39.4	719	47.9	762	56.5	803	65.3	840	73.8	878	83.0	896	87.7		
47000	2557	598	26.8	647	34.7	692	42.7	735	51.2	777	60.2	817	69.4	853	78.2	893	88.4				
49500	2693	619	29.3	666	37.7	709	45.9	750	54.4	791	63.8	831	73.3	868	83.1	904	92.9				
52000	2829	640	32.1	688	41.2	729	49.7	768	58.4	807	67.8	846	77.7	883	87.8						

Performance certified is for installation Type B: Free inlet, Ducted outlet. Power rating (BHP) does not include transmission losses. Performance ratings do not include the effects of appurtenances (accessories).

QUICK-SELECTION CURVES

The following charts show comparative performance curves for full-width and 75% narrow-width Medium Pressure [MP], and full-width and 67% narrow-width High Pressure [HP] FRP General-Purpose Fume Exhausters. These curves represent the maximum static pressure and capacity available at each fan's maximum safe operating speed. The charts are intended to assist in initially selecting the proper fan size and design.

Narrow-width fans can generate higher static pressures through higher operating speeds. Maximum safe fan

speeds increase as the wheel width decreases [see maximum safe wheel speed chart for narrow-width wheels on page 11].

For specific operating points of full-width Medium Pressure and High Pressure FRP General-Purpose Fume Exhausters, refer to the performance tables on pages 6 through 9. For points of operation not shown in those tables, or for performance of narrow-width fans, refer to The New York Blower Company Electronic Catalog for further details.

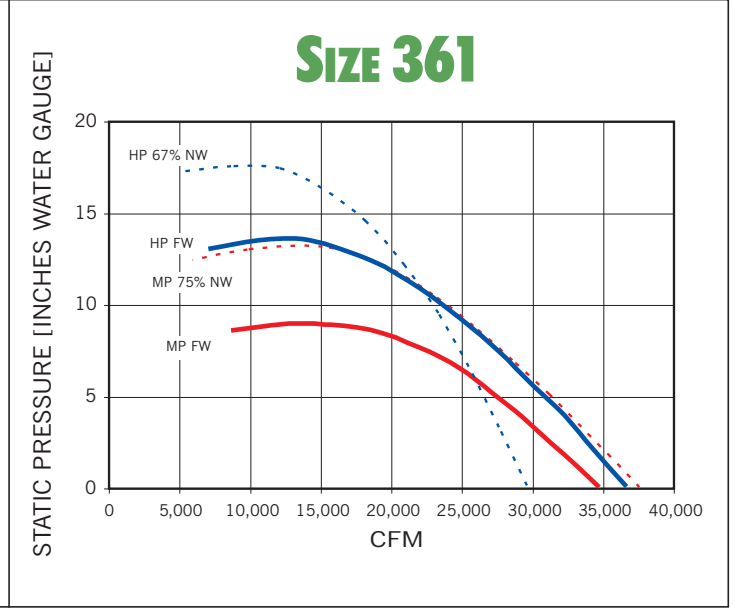
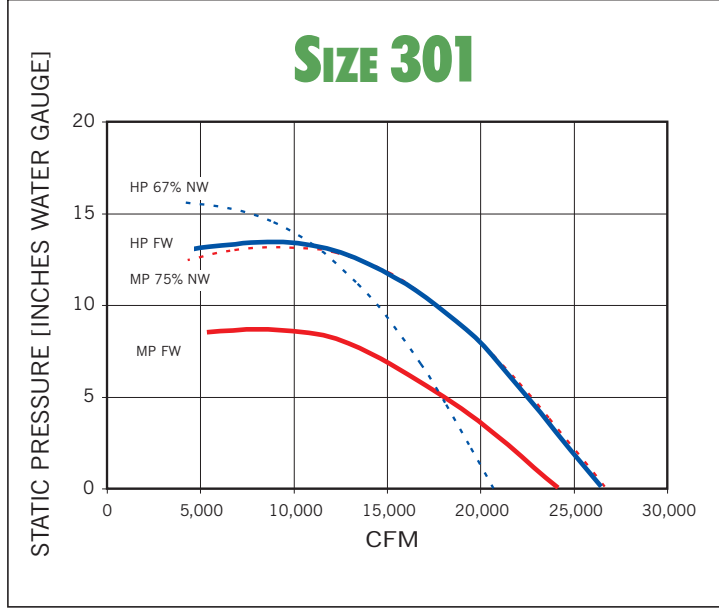
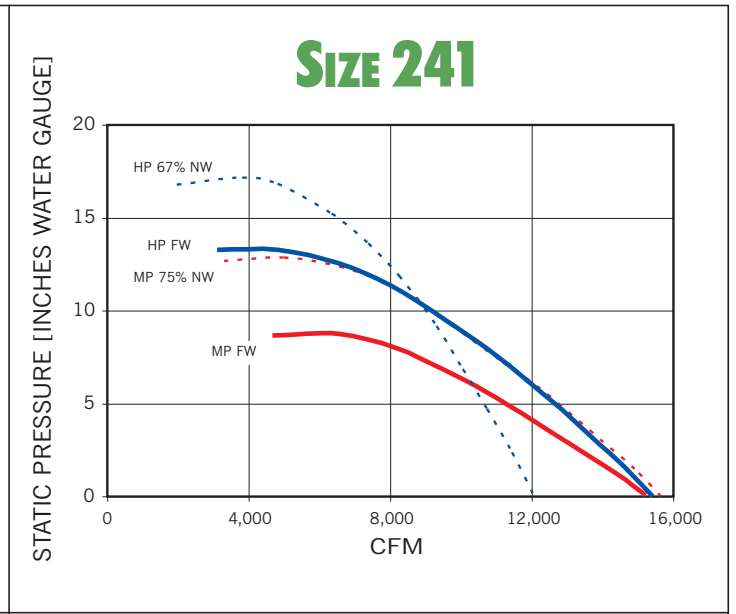
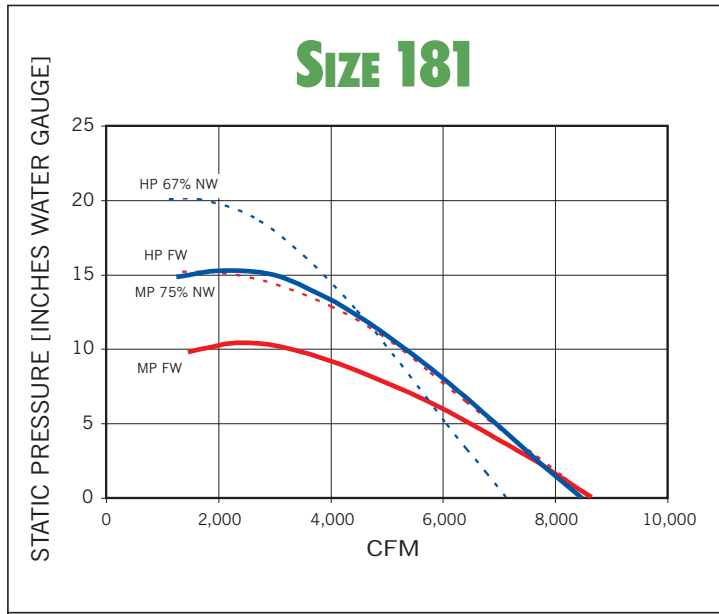

LEGEND

- MP full-width
- HP full-width
- - - - MP 75% narrow-width
- - - - HP 67% narrow-width

Performance shown is installation Type B: Free inlet, Ducted outlet.
Performance ratings do not include the effects of appurtenances in airstream.

NARROW-WIDTH CONSTRUCTION

Narrow-width wheel construction is available on FRP General-Purpose Fume Exhausters, Sizes 181 to 601, to 75% of full-width on Medium Pressure Fans and to 67% of full-width on High Pressure Fans. Narrow-width construction permits “fine tuning” of fan performance, which is especially critical for Arrangement 8 fans.

Using state-of-the-art design software, narrow-width construction now also enables higher static pressures through higher operating speeds. Chart V shows the maximum safe speed for narrow-width wheels. The maximum safe speed of wheels increases as the width decreases. Contact your New York Blower representative or refer to your **nyb** Electronic Catalog for additional information.

CHART V MAXIMUM SAFE WHEEL SPEED FOR NARROW-WIDTH WHEELS AT 70°F

Size	RPM	
	75% NW-MP	67% NW-HP
181	3570	4200
241	2470	2920
301	1985	2320
361	1680	1960
421	1420	1620
481	1200	1400
541	1000	1180
601	905	1030

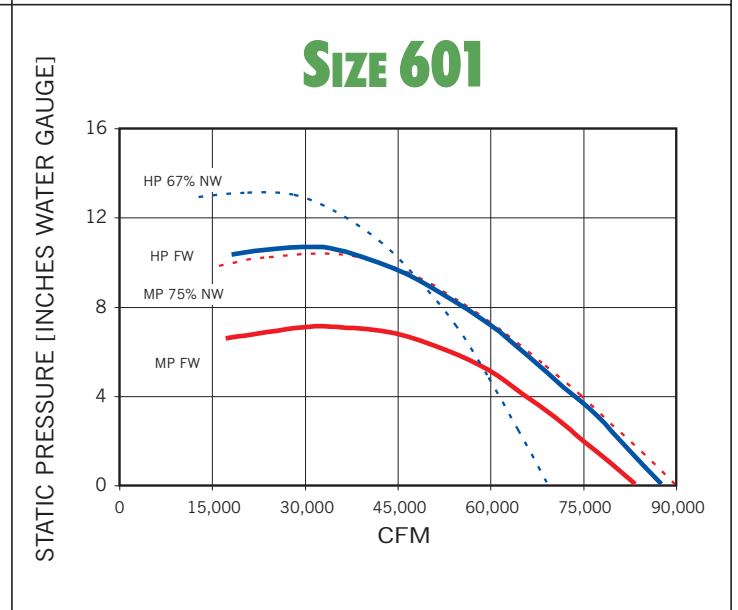
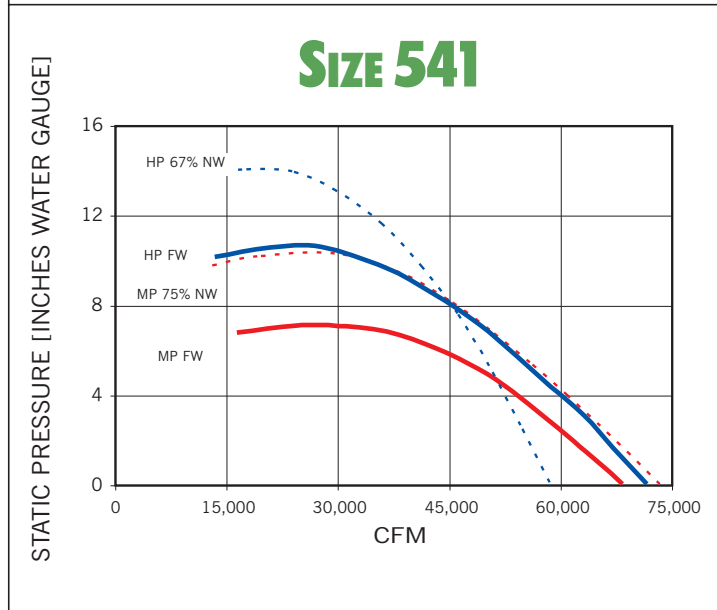
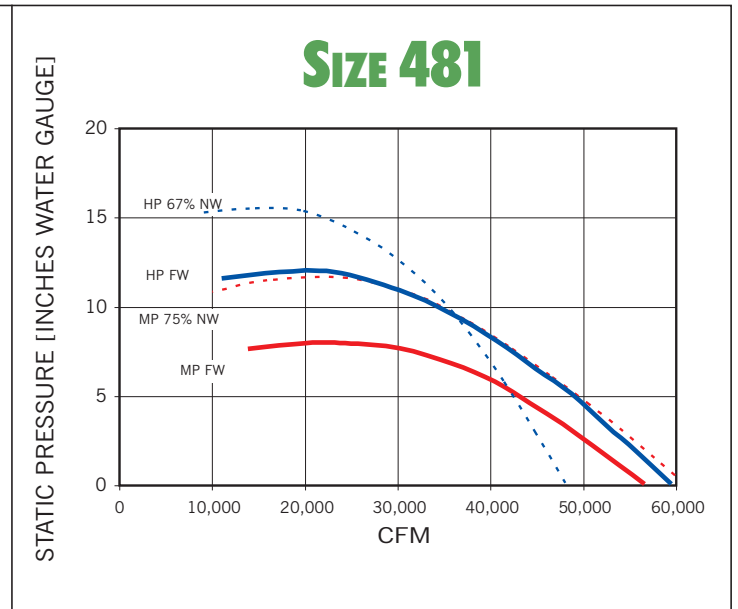
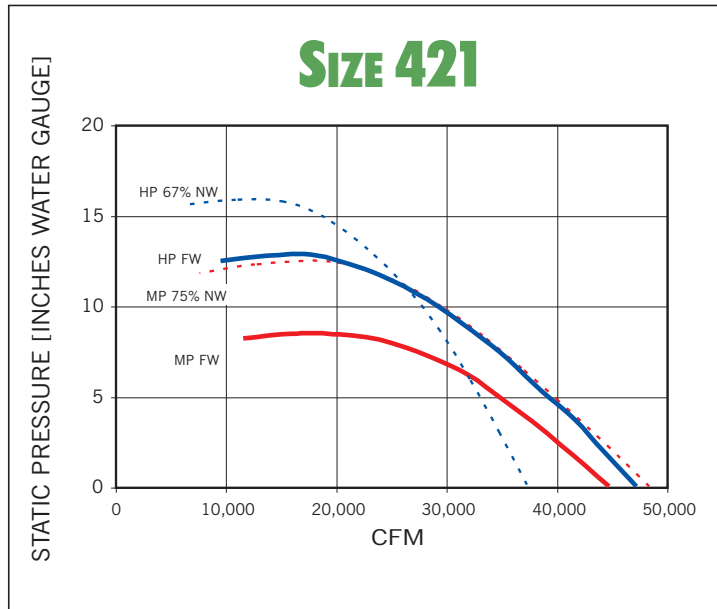

LEGEND

- MP full-width
- HP full-width
- - - MP 75% narrow-width
- - - HP 67% narrow-width

Performance shown is installation Type B: Free inlet, Ducted outlet.
Performance ratings do not include the effects of appurtenances in airstream.

SPECIFICATIONS

Size	Fan type	Shaft diameter [inches]			Bearings					
		Arr. 1, 8, 9	Arr. 9-E, 9-F	Arr. 10	Arr. 1, 9		Arr. 8	Arr. 9-E, 9-F		Arr. 10
					Inboard	Outboard	Inboard/outboard	Inboard	Outboard	Inboard/outboard
121	MP	1 ³ / ₁₆	—	1 ³ / ₁₆	A	A	A	—	—	A
151	MP	1 ⁷ / ₁₆	—	1 ⁷ / ₁₆	A	A	A	—	—	A
181	MP	1 ¹¹ / ₁₆	1 ¹¹ / ₁₆	1 ¹¹ / ₁₆	A	A	A	A	A	A
	HP	1 ¹⁵ / ₁₆	1 ¹⁵ / ₁₆	—	A	A	A	A	A	—
241	MP	1 ¹⁵ / ₁₆	1 ¹⁵ / ₁₆	1 ¹⁵ / ₁₆	A	A	A	A	A	A
	HP	1 ¹⁵ / ₁₆	1 ¹⁵ / ₁₆	—	A	E	A	A	E	—
301	MP	1 ¹⁵ / ₁₆	1 ¹⁵ / ₁₆	2 ³ / ₁₆	A	E	A	A	E	C
	HP	2 ³ / ₁₆	2 ³ / ₁₆	—	A	E	A	A	E	—
361	MP	1 ¹⁵ / ₁₆	2 ³ / ₁₆	2 ³ / ₁₆	A	E	A	A	E	C
	HP	2 ³ / ₁₆	2 ³ / ₁₆	—	E	E	C	E	E	—
421	MP	2 ¹¹ / ₁₆	2 ¹¹ / ₁₆	—	A	E	A	A	E	—
	HP	2 ¹¹ / ₁₆	2 ¹⁵ / ₁₆	—	E	E	C	E	E	—
481	MP	2 ¹¹ / ₁₆	2 ¹¹ / ₁₆	—	A	E	A	A	E	—
	HP	2 ¹⁵ / ₁₆	2 ¹⁵ / ₁₆	—	E	E	C	E	E	—
541	MP	3 ⁷ / ₁₆	3 ⁷ / ₁₆	—	A	E	C	A	E	—
	HP	3 ⁷ / ₁₆	3 ⁷ / ₁₆	—	E	E	C	E	E	—
601	MP	3 ⁷ / ₁₆	3 ⁷ / ₁₆	—	A	E	C	A	E	—
	HP	3 ⁷ / ₁₆	3 ¹⁵ / ₁₆	—	E	E	C	E	E	—

A—Link Belt P3-U200 ball bearing. C—Sealmaster MPD ball bearing. E—Linkbelt P-B22400 spherical roller bearing. **nyb** reserves the right to substitute bearings of equal quality.

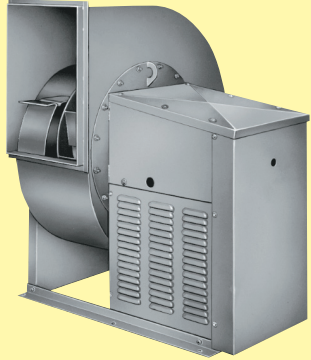

CORROSION-RESISTANT ALTERNATIVES

New York Blower metal fans can be constructed of various alloys including 304 and 316 stainless steel and aluminum. A wide range of corrosion-resistant coatings is also available.

Size	Weights [lbs.]														Wheel WR ² [lb.-ft. ²]	
	Bare fan						Wheel and shaft assembly									
	Arr. 1, 9		Arr. 8		Arr. 9-E		Arr. 9-F		Arr. 10	Arr. 1, 8, 9		Arr. 9-E, 9-F		Arr. 10	MP	HP
MP	HP	MP	HP	MP	HP	MP	HP	MP	MP	HP	MP	HP	MP	MP	HP	
121	135	NA	175	NA	NA	NA	NA	NA	135	18	NA	NA	NA	18	2	NA
151	175	NA	230	NA	NA	NA	NA	NA	170	26	NA	NA	NA	26	4	NA
181	230	195	305	270	270	240	NA	NA	240	35	39	39	44	37	10	9
241	415	375	600	565	490	455	NA	NA	410	55	54	60	59	59	26	25
301	690	615	955	880	730	655	NA	NA	605	76	79	80	84	86	57	56
361	1180	1080	OA	OA	1220	1110	1535	1420	795	94	100	108	104	102	117	115
421	1525	1390	OA	OA	1555	1430	1920	1790	NA	192	186	198	207	NA	293	287
481	1875	1690	OA	OA	1910	1725	2295	2115	NA	233	239	239	246	NA	499	489
541	2765	2495	OA	OA	2805	2535	3370	3100	NA	378	366	388	377	NA	922	903
601	3195	2870	OA	OA	3240	3005	3800	3570	NA	461	445	471	505	NA	1445	1416

NA—Not available. OA—On application.

FLANGED OUTLET DIMENSIONS [Inches]

Furnished as standard [without holes].

Available with holes drilled as shown.

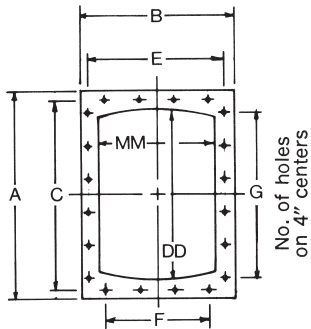

No. of holes on 4" centers

FLANGED INLET DIMENSIONS [Inches]

Furnished as an option [without holes].

Available with holes drilled as shown.

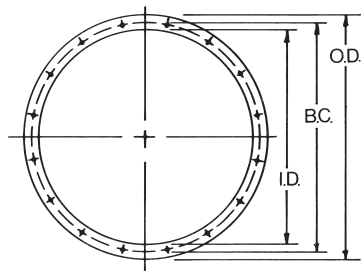

Size	A	B		C	DD	E		F		G	MM		Hole dia.	Flange thickness	Size	O.D.	B.C. [bolt circle]	I.D.	No. and size of holes	Flange thickness
		MP	HP			MP	HP	MP	HP											
121	18 ¹ / ₈	13 ¹ / ₂	—	16 ⁵ / ₈	13 ³ / ₄	12	—	4	—	4	9 ¹ / ₈	—	7 ¹ / ₁₆	3 ⁸ / ₁₆	121	15 ³ / ₄	14 ⁵ / ₈	12 ¹ / ₂	8-7 ¹ / ₁₆	1 ¹ / ₄
151	21 ¹ / ₄	15 ¹ / ₂	—	19 ³ / ₄	16 ⁷ / ₈	14	—	4	—	4	11 ¹ / ₈	—	7 ¹ / ₁₆	3 ⁸ / ₁₆	151	19 ¹ / ₄	17 ⁷ / ₈	15 ¹ / ₂	8-7 ¹ / ₁₆	1 ¹ / ₄
181	25 ¹ / ₈	18	16 ¹ / ₄	23 ³ / ₄	20 ³ / ₄	16 ⁵ / ₈	14 ⁷ / ₈	4	2	6	13 ⁵ / ₈	11 ⁷ / ₈	7 ¹ / ₁₆	1 ¹ / ₂	181	23 ¹ / ₂	21 ³ / ₄	19	16-7 ¹ / ₁₆	1 ¹ / ₄
241	32 ¹ / ₈	22 ⁵ / ₈	20 ³ / ₈	30 ³ / ₄	27 ³ / ₄	21 ¹ / ₄	19	4	4	8	18 ¹ / ₄	16	7 ¹ / ₁₆	1 ¹ / ₂	241	30 ⁷ / ₈	29 ¹ / ₈	26	16-7 ¹ / ₁₆	1 ¹ / ₄
301	38 ³ / ₈	26 ³ / ₄	24	37	34	25 ³ / ₈	22 ⁵ / ₈	6	4	10	22 ³ / ₈	19 ⁵ / ₈	7 ¹ / ₁₆	1 ¹ / ₂	301	37 ¹ / ₈	35 ¹ / ₈	32	16-7 ¹ / ₁₆	5 ¹ / ₁₆
361	45 ⁷ / ₈	31 ⁵ / ₈	28 ¹ / ₂	44 ¹ / ₂	41 ¹ / ₂	30 ³ / ₄	27 ¹ / ₈	6	6	12	27 ¹ / ₄	24 ³ / ₈	7 ¹ / ₁₆	5 ⁸ / ₁₆	361	44 ³ / ₈	42 ³ / ₈	38	16-7 ¹ / ₁₆	5 ¹ / ₁₆
421	54 ¹ / ₈	37 ³ / ₄	34 ¹ / ₈	51 ³ / ₄	47 ³ / ₄	35 ³ / ₈	31 ³ / ₄	8	6	12	31 ³ / ₈	27 ³ / ₄	9 ¹ / ₁₆	5 ⁸ / ₁₆	421	50 ¹ / ₂	48 ¹ / ₂	44	24-9 ¹ / ₁₆	3 ⁸ / ₁₆
481	60 ⁷ / ₈	42 ¹ / ₄	38 ¹ / ₈	58 ¹ / ₂	54 ¹ / ₂	39 ⁷ / ₈	35 ³ / ₄	10	8	14	35 ⁷ / ₈	31 ³ / ₄	9 ¹ / ₁₆	5 ⁸ / ₁₆	481	57	55 ¹ / ₈	50	24-9 ¹ / ₁₆	3 ⁸ / ₁₆
541	68	46 ⁷ / ₈	42 ¹ / ₈	65 ⁵ / ₈	61 ⁵ / ₈	44 ¹ / ₂	39 ³ / ₄	10	8	16	40 ¹ / ₂	35 ³ / ₄	9 ¹ / ₁₆	5 ⁸ / ₁₆	541	64	62 ¹ / ₈	56	24-9 ¹ / ₁₆	1 ¹ / ₂
601	74 ¹ / ₂	51 ¹ / ₄	46 ¹ / ₈	72 ¹ / ₈	68 ¹ / ₈	48 ⁷ / ₈	43 ³ / ₄	12	10	18	44 ⁷ / ₈	39 ³ / ₄	9 ¹ / ₁₆	5 ⁸ / ₁₆	601	70 ¹ / ₂	68 ³ / ₈	62	32-9 ¹ / ₁₆	1 ¹ / ₂

Tolerance: ± 1/32"

Tolerance: ± 1/32"

ARRANGEMENT 10 FANS

L is OD of collar. DD, FF, and MM are inside dimensions. JJ is from centerline over inlet collar.
Dimensions not to be used for construction unless certified.

DIMENSIONS [INCHES] SIZES 121-361 ROTATABLE HOUSINGS

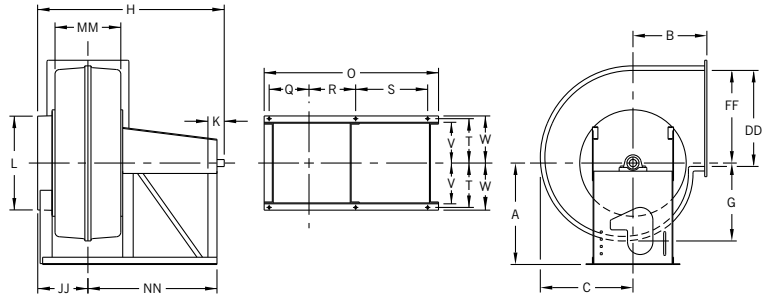

Size	A*	B	C	DD	FF	G	H	JJ	K	L	MM	NN	O
121	15 1/2	12	14 1/4	13 3/4	14 7/8	12 1/4	33 3/8	8 1/8	2 1/2	13	9 1/8	24 5/8	32 1/2
151	17 1/2	14 5/8	17 1/8	16 7/8	17 7/8	14 5/8	37 7/8	9 1/8	3	16	11 1/8	27 5/8	36 1/2
181	21 1/4	16	20 3/8	20 3/4	19 1/2	17 3/8	40 7/8	10 3/8	3 1/2	19 1/2	13 5/8	28 7/8	38 3/4
241	28	20	26 3/4	27 3/4	26 1/4	22 5/8	50 1/8	12 3/4	4 1/2	26 1/2	18 1/4	35 3/8	48 1/8
301	32 1/2	23 1/2	32 3/8	34	32 1/8	27 3/8	57 3/8	15 7/8	5 1/2	32 5/8	22 3/8	38 3/8	53 1/4
361	39 1/2	29	39 1/4	41 1/2	39 1/8	33 1/4	66 3/8	19 3/8	5 1/2	38 5/8	27 1/4	43 7/8	61 1/4

Size	Q	R	S	T	V	W	a	b	c	d	Square key	Base hole dia.	Max. motor frame size		Max. motor limitation C-NW
													Open	TEFC	
121	6 1/8	6 1/2	16 3/8	7 3/8	6 1/2	8	13 1/2	19 3/8	14 3/4	11 1/8	1/4	5/8	215T	184T	14 1/2
151	7 1/8	8 5/8	17 3/8	8 7/8	8	9 1/2	16 1/8	23 1/4	17 5/8	13 3/8	3/8	5/8	215T	215T	16 5/8
181	8 5/8	9 3/8	17 3/8	9 3/8	8 1/4	10 1/4	19 1/8	26 3/4	21	15 3/4	3/8	5/8	215T	215T	16 5/8
241	11 3/8	12 1/2	19 7/8	12 1/4	11	13	25	34 1/4	27 5/8	20 3/8	1/2	5/8	256T	254T	18 5/8
301	13 3/8	14 5/8	20 3/4	13 5/8	11 3/4	14 3/4	30 1/4	40 7/8	33 1/4	24 5/8	1/2	5/8	284T	256T	19 1/2
361	15 7/8	17 1/8	23 3/4	16	14	17	36 3/4	49 3/4	40 5/8	29 7/8	1/2	5/8	284T	284T	22 1/2

*Add 3" for Bottom Horizontal or Bottom Angular Up discharges. C-NW is maximum motor case length [NEMA C minus NEMA NW]. Tolerance: ± 1/16"

INLET BOXES FOR FRP GENERAL-PURPOSE FUME EXHAUSTERS

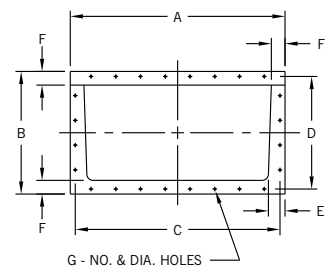
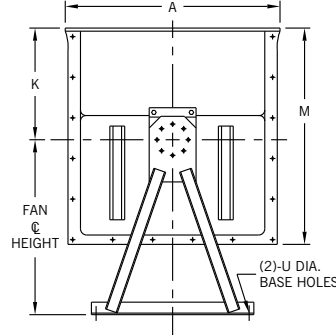
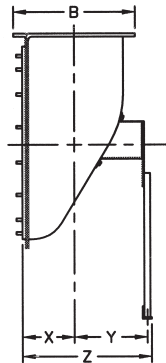
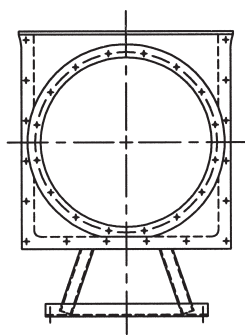

Dimensions not to be used for construction unless certified.

1. Rectangular flange is furnished without holes as standard...available with holes on 4" centers straddling centerlines.
2. Round flange is furnished with holes to match drilling pattern of flanged inlet.
3. Base-bar dimensions match fan base-bar dimensions.

DIMENSIONS [INCHES]

Size	Fan inlet area [ft.²]	A	B	C	D	E	F	G		K	M	U Base hole diameter	X	Y	Z	Wt. [lbs.]
								No.	Dia.							
181	1.97	26 7/8	15 7/8	25 1/2	14 1/2	29 1/16	23 1/16	16	7/16	13 1/2	26 1/2	5/8	6	9 3/4	16 3/8	69
241	3.69	34 3/8	19 5/8	33	18 1/4	21 1/16	23 1/16	24	7/16	17 7/8	34 5/8	5/8	7 7/8	11 1/4	19 3/4	95
301	5.59	41 7/8	23 1/2	40 1/2	22 1/8	27 7/8	23 1/16	28	7/16	22 3/8	42 7/8	5/8	9 7/8	13 3/8	24 1/8	128
361	7.88	49 3/8	27 1/4	48	25 7/8	3	23 1/16	36	7/16	26 7/8	51 1/8	5/8	11 3/4	14 3/4	27 3/8	170
421	10.56	56 7/8	31 1/8	55 1/2	29 3/4	3 1/8	23 1/16	44	7/16	31 3/8	59 1/2	7/8	13 5/8	16 1/2	31	262
481	13.64	66 5/8	37 1/8	64 1/4	34 3/4	4 1/4	33 1/16	48	9/16	35 7/8	67 3/4	7/8	15 3/4	21 5/8	38 3/4	374
541	17.10	74 1/8	40 7/8	71 3/4	38 1/2	4 3/8	33 1/16	56	9/16	40 3/8	76	1	18	23 3/8	42 3/4	575

Tolerance: ± 1/16"

ARRANGEMENTS 1, 8, 9, 9-E FANS

L is OD of collar. DD, FF, and MM are inside dimensions. JJ is from centerline over inlet collar.
Dimensions not to be used for construction unless certified.

DIMENSIONS [INCHES] SIZES 121-301 ROTATABLE HOUSINGS

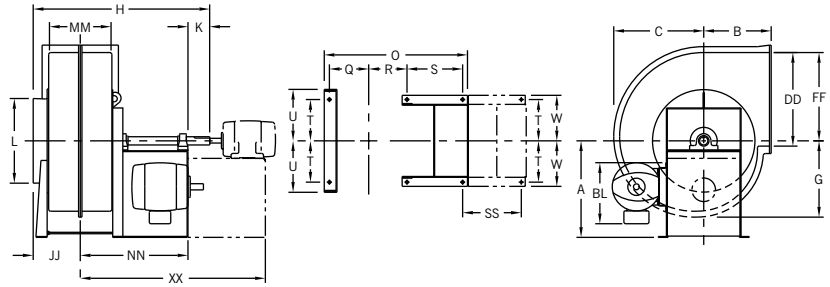

ARRANGEMENTS 1, 8, 9, 9-E FANS

Size	A	B	C		DD	FF	G		JJ		K	L	MM	
			MP	HP			MP	HP	MP	HP			MP	HP
121	16	12	14 ¹ / ₄	NA	13 ³ / ₄	14 ⁷ / ₈	12 ¹ / ₄	NA	8 ¹ / ₈	NA	2 ¹ / ₂	13	9 ¹ / ₈	NA
151	19	14 ⁵ / ₈	17 ¹ / ₈	NA	16 ⁷ / ₈	17 ⁷ / ₈	14 ⁵ / ₈	NA	9 ¹ / ₈	NA	3	16	11 ¹ / ₈	NA
181	21 ³ / ₄	16	20 ³ / ₈	18 ³ / ₄	20 ³ / ₄	19 ¹ / ₂	17 ³ / ₈	15 ³ / ₄	10 ³ / ₈	9 ¹ / ₂	4	19 ¹ / ₂	13 ⁵ / ₈	11 ⁷ / ₈
241	28 ⁵ / ₈	20	26 ³ / ₄	25 ¹ / ₄	27 ³ / ₄	26 ¹ / ₄	22 ⁵ / ₈	21 ¹ / ₈	12 ³ / ₄	11 ⁵ / ₈	4 ¹ / ₂	26 ¹ / ₂	18 ¹ / ₄	16
301	34 ³ / ₄	23 ¹ / ₂	32 ³ / ₈	30 ⁷ / ₈	34	32 ¹ / ₈	27 ³ / ₈	26	15 ⁷ / ₈	14 ¹ / ₂	5	32 ⁵ / ₈	22 ³ / ₈	19 ⁵ / ₈

Size	Q		R		T	U	W	a	b	c	d	BL†	Base hole diameter
	MP	HP	MP	HP									
121	6 ³ / ₈	NA	6 ¹ / ₂	NA	7 ³ / ₈	8 ⁷ / ₈	8	13 ¹ / ₂	19 ³ / ₈	14 ³ / ₄	11 ¹ / ₈	16 ³ / ₈	5/8
151	7 ³ / ₈	NA	7 ¹ / ₂	NA	8 ⁷ / ₈	10 ³ / ₈	9 ¹ / ₂	16 ¹ / ₈	23 ¹ / ₄	17 ⁵ / ₈	13 ³ / ₈	16 ³ / ₈	5/8
181	8 ⁵ / ₈	7 ³ / ₄	8 ³ / ₄	7 ⁷ / ₈	9 ³ / ₈	10 ⁷ / ₈	10 ¹ / ₄	19 ¹ / ₈	26 ³ / ₄	21	15 ³ / ₄	22 ¹ / ₈	5/8
241	11 ¹ / ₂	10 ³ / ₈	11 ⁵ / ₈	10 ¹ / ₂	12 ¹ / ₄	14 ³ / ₈	13 ¹ / ₂	25	34 ¹ / ₄	27 ⁵ / ₈	20 ³ / ₈	26 ³ / ₈	3/4
301	13 ⁵ / ₈	12 ¹ / ₄	13 ³ / ₄	12 ³ / ₈	14 ⁷ / ₈	16 ⁷ / ₈	16 ¹ / ₈	30 ¹ / ₄	40 ⁷ / ₈	33 ¹ / ₄	24 ⁵ / ₈	29 ⁵ / ₈	3/4

† For Arrangements 9 and 9-E fans only. BL = slide base (AL + BT) / 2 + motor AB.

Tolerance: ± 1/8"

ARRANGEMENTS 1, 8, 9 FANS

Size	H		NN		O		S	Max. motor limitation*	
	MP	HP	MP	HP	MP	HP		C-NW	Frame
151	34 ⁷ / ₈	NA	22 ³ / ₄	NA	31 ⁵ / ₈	NA	13 ³ / ₄	15 ¹ / ₂	184T
181	38 ³ / ₈	36 ⁵ / ₈	24	23 ¹ / ₈	34 ¹ / ₈	32 ³ / ₈	13 ³ / ₄	15 ¹ / ₂	184T
241	46	43 ³ / ₄	28 ⁷ / ₈	27 ³ / ₄	42 ¹ / ₄	40	15 ¹ / ₄	18	215T
301	55 ³ / ₄	53	35	33 ⁵ / ₈	50 ¹ / ₂	47 ³ / ₄	19 ¹ / ₄	22	256T

* For Arrangement 9 fans only. C-NW is maximum motor case length [NEMA C minus NEMA NW].

Tolerance: ± 1/8"

ARRANGEMENT 8 FANS

Size	Motor frame	XX		SS
		MP	HP	
121	143T-145T 182T-184T	35 ¹ / ₄	NA	13 ¹ / ₂ 15
		36 ³ / ₄	NA	
151	143T-145T 182T-184T	36 ³ / ₄	NA	14 15 ¹ / ₂
		38 ¹ / ₄	NA	
181	143T-145T 182T-184T 213T-215T 254T-256T	39	38 ¹ / ₈	15 16 ¹ / ₂ 19 ³ / ₈ 23 ³ / ₄
		40 ¹ / ₂	39 ⁵ / ₈	
		43 ³ / ₈	42 ¹ / ₂	
		47 ³ / ₄	46 ⁷ / ₈	
241	182T-184T 213T-215T 254T-256T 284TS-286TS 324TS-326TS	46 ³ / ₈	45 ¹ / ₄	17 ¹ / ₂ 20 ³ / ₈ 24 ³ / ₄ 26 ¹ / ₂ 28 ¹ / ₂
		49 ¹ / ₄	48 ¹ / ₈	
		53 ⁵ / ₈	52 ¹ / ₂	
		55 ³ / ₈	54 ¹ / ₄	
		57 ³ / ₈	56 ¹ / ₄	
301	213T-215T 254T-256T 284TS-286TS 324TS-326TS	56 ³ / ₈	55	21 ³ / ₈ 25 ³ / ₄ 27 ¹ / ₂ 29 ¹ / ₂
		60 ³ / ₄	59 ³ / ₈	
		62 ¹ / ₂	61 ¹ / ₈	
		64 ¹ / ₂	63 ¹ / ₈	

Tolerance: ± 1/8"

ARRANGEMENT 9-E FANS

Size	H		NN		O		S	Max. motor limitation		
	MP	HP	MP	HP	MP	HP		C-NW	Frame	
										181
241	52 ¹ / ₂	50 ¹ / ₄	35 ³ / ₈	34 ¹ / ₄	48 ³ / ₄	46 ¹ / ₂	21 ³ / ₄	24 ¹ / ₂	27	286T
301	60 ³ / ₄	58	40	38 ⁵ / ₈	55 ¹ / ₂	52 ³ / ₄	24 ¹ / ₄	27	326T	

C-NW is maximum motor case length [NEMA C minus NEMA NW].

Tolerance: ± 1/8"

FAN DISCHARGES – VIEWED FROM DRIVE SIDE

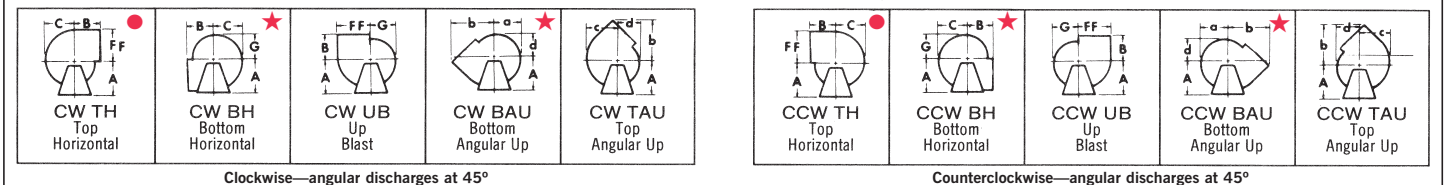

● If inlet box is furnished on Sizes 361 to 601 in Top Horizontal fan position, inlet box may extend below floor line.

★ Arrangement 10 fans with Bottom Horizontal or Bottom Angular Up discharges are equipped with a 3-inch channel sub-base...add 3" to the fan centerline height.

ARRANGEMENTS 1, 9, 9-E, 9-F FANS

L is OD of collar. DD, FF, and MM are inside dimensions. JJ is from centerline over inlet collar.
Dimensions not to be used for construction unless certified.

DIMENSIONS [INCHES]
SIZES 361-601
NON-ROTATABLE
HOUSINGS

ARRANGEMENTS 1, 9 FANS

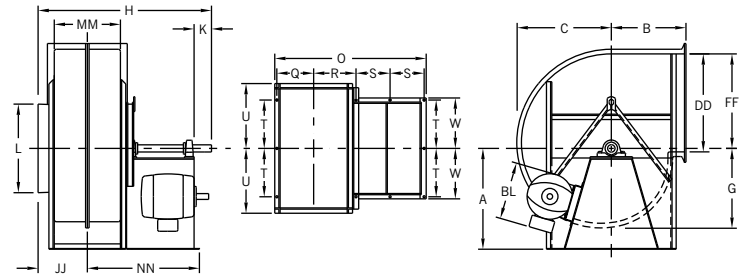

ARRANGEMENTS 1, 9 FANS

Size	H		NN		O		S	Max. motor limitation*	
	MP	HP	MP	HP	MP	HP		C-NW	Frame
	361	68 ¹ / ₄	65 ¹ / ₈	46 ¹ / ₈	44 ⁵ / ₈	63			
421	72 ³ / ₈	68 ³ / ₄	48 ¹ / ₄	46 ³ / ₈	67 ¹ / ₈	63 ¹ / ₂	13	22	256T
481	77	72 ⁷ / ₈	50 ¹ / ₂	48 ¹ / ₂	71 ³ / ₄	67 ⁵ / ₈	13	22	256T
541	91 ¹ / ₄	86 ¹ / ₂	60 ⁷ / ₈	58 ¹ / ₂	85 ¹ / ₂	80 ³ / ₄	16	27	326T
601	95 ⁵ / ₈	90 ¹ / ₂	63 ³ / ₈	60 ¹ / ₂	89 ⁷ / ₈	84 ³ / ₄	16	27	326T

* For Arrangement 9 fans only.
C-NW is maximum motor case length [NEMA C minus NEMA NW].
Tolerance: ± 1/32"

ARRANGEMENTS 9-E, 9-F FANS

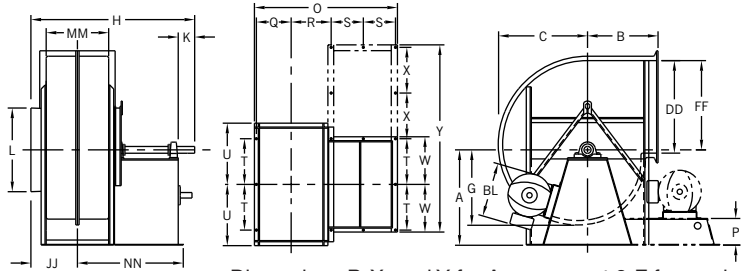

Dimensions P, X, and Y for Arrangement 9-F fans only.

ARRANGEMENTS 1, 9, 9-E, 9-F FANS

Size	A			B	C		DD	FF	G		JJ		K	L	MM	
	TH	BH, BAU	UB, TAU		MP	HP			MP	HP	MP	HP			MP	HP
361	34	44 ¹ / ₂	40	29	39 ¹ / ₄	37 ⁵ / ₈	41 ¹ / ₂	39 ¹ / ₈	33 ¹ / ₄	31 ⁵ / ₈	19 ³ / ₈	17 ³ / ₄	5 ¹ / ₂	38 ⁵ / ₈	27 ¹ / ₄	24 ¹ / ₈
421	39	51	46	32 ¹ / ₂	44 ⁷ / ₈	43 ¹ / ₄	47 ³ / ₄	44 ⁷ / ₈	38	36 ³ / ₈	21 ³ / ₈	19 ⁵ / ₈	5 ¹ / ₂	44 ³ / ₄	31 ³ / ₈	27 ³ / ₄
481	44	57 ¹ / ₂	52	36 ¹ / ₂	51	49 ³ / ₈	54 ¹ / ₂	51 ³ / ₈	43 ¹ / ₈	41 ¹ / ₂	23 ³ / ₄	21 ⁵ / ₈	5 ¹ / ₂	50 ³ / ₄	35 ⁷ / ₈	31 ³ / ₄
541	49 ¹ / ₂	65	59	42 ¹ / ₂	57 ⁵ / ₈	55 ⁷ / ₈	61 ⁵ / ₈	58 ¹ / ₈	48 ³ / ₄	46 ⁷ / ₈	27 ¹ / ₈	24 ³ / ₄	7	57	40 ¹ / ₂	35 ³ / ₄
601	54 ¹ / ₂	71 ¹ / ₂	64 ¹ / ₂	46	63 ¹ / ₂	61 ³ / ₄	68 ¹ / ₈	64 ¹ / ₄	53 ⁵ / ₈	51 ⁷ / ₈	29 ³ / ₈	26 ³ / ₄	7	63	44 ⁷ / ₈	39 ³ / ₄

Size	Q		R		T	U	W	a	b	c	d	BL†	Base hole Dia.
	MP	HP	MP	HP									
361	15 ⁵ / ₈	14	18 ⁵ / ₈	17 ¹ / ₈	17 ¹ / ₂	25	19	36 ³ / ₄	49 ³ / ₄	40 ⁵ / ₈	29 ⁷ / ₈	23 ¹ / ₂	7/8
421	17 ⁵ / ₈	15 ⁷ / ₈	20 ³ / ₄	18 ⁷ / ₈	20	28 ¹ / ₈	21 ¹ / ₂	41 ⁷ / ₈	57	46 ¹ / ₄	34	30 ¹ / ₄	7/8
481	20	17 ⁷ / ₈	23	21	23	31 ³ / ₈	24 ¹ / ₂	47 ¹ / ₂	64 ¹ / ₂	56 ³ / ₄	38 ⁵ / ₈	31 ¹ / ₄	7/8
541	22 ⁷ / ₈	20 ¹ / ₂	26 ⁷ / ₈	24 ¹ / ₂	25	35 ⁷ / ₈	26 ¹ / ₂	53 ⁷ / ₈	73 ³ / ₈	59 ¹ / ₂	43 ⁵ / ₈	35 ¹ / ₄	1
601	25	22 ¹ / ₂	29 ¹ / ₈	26 ¹ / ₂	26 ¹ / ₂	39	28 ¹ / ₂	59	80 ³ / ₈	62 ³ / ₈	45 ³ / ₄	39 ¹ / ₄	1

† For Arrangements 9 and 9-E fans only. BL = slide base (AL + BT) / 2 + motor AB. Tolerance: ± 1/32"

ARRANGEMENTS 9-E, 9-F FANS

Size	H		NN		O		S	Arrangement 9-F fans only			Maximum motor limitations			
	MP	HP	MP	HP	MP	HP		P	X	Y	Arrangement 9-E		Arrangement 9-F	
											C-NW	Motor frame	C-NW	Motor frame
361	72 ¹ / ₄	69 ¹ / ₈	50 ¹ / ₈	48 ⁵ / ₈	67	63 ⁷ / ₈	15	12	19	76	26	326T	29	365T
421	76 ³ / ₈	72 ³ / ₄	52 ¹ / ₄	50 ³ / ₈	71 ¹ / ₈	67 ¹ / ₂	15	15	19	81	26	326T	29	365T
481	81	76 ⁷ / ₈	54 ¹ / ₂	52 ¹ / ₂	75 ³ / ₄	71 ⁵ / ₈	15	15	21	91	26	326T	29	365T
541	95 ¹ / ₄	90 ¹ / ₂	64 ⁷ / ₈	62 ¹ / ₂	89 ¹ / ₂	84 ³ / ₄	18	18	25	104	31	365T	35	405T
601	99 ⁵ / ₈	94 ¹ / ₂	67 ¹ / ₈	64 ¹ / ₂	93 ⁷ / ₈	88 ³ / ₄	18	18	25	107	31	365T	35	405T

NOTE: Sizes 361-601 Arrangement 8 pedestal dimensions are dependent on motor size. Tolerance: ± 1/32"

The New York Blower Company has a policy of continuous product development and reserves the right to change designs and specifications without notice.

IN CORROSION-RESISTANT

FRP FANS...

STANDARDS MAKE A DIFFERENCE!

In FRP Fans, construction quality and accurate air ratings are vital. That's where standards make a big difference.

The American Society for Testing and Materials [ASTM] developed a standard specification for FRP fans and blowers. ASTM D 4167, Standard Specification for FIBER-REINFORCED PLASTIC FANS AND BLOWERS, defines minimum specifications for construction of major fan elements. It is a concise, understandable, readily available standard.

The Air Movement and Control Association's [AMCA] Certified Ratings Program provides assurance of accurate ratings. AMCA Standard 210 describes how fans are to be tested for air performance. The AMCA Certified Ratings Program requires the fan manufacturer to guarantee aerodynamic performance within close tolerances of the manufacturer's published ratings.

The Society of the Plastic Industry's [SPI] Users Guide to RP Industrial Equipment, #2-Fans, Guide for Purchasing or Specifying Reinforced Plastic Fans and Blowers, recommends specification of both the ASTM and AMCA standards.

The New York Blower Company's complete line of FRP Fans—Fume Exhausters, Radial Fume Exhausters, Pressure Blowers, General-Purpose Fume Exhausters—meet these standards.



FRP PRESSURE BLOWERS

5,000 CFM
36" WG

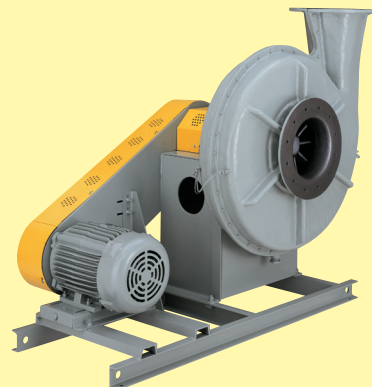

FRP RADIAL FUME EXHAUSTERS

7,500 CFM
14" WG



FRP FUME EXHAUSTERS

84,000 CFM
25" WG

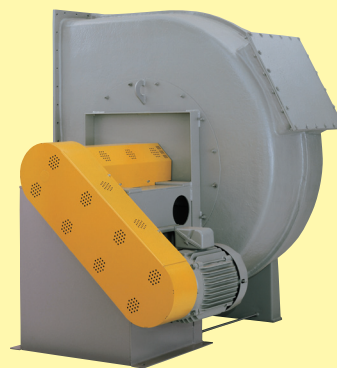

FRP GENERAL-PURPOSE FUME EXHAUSTERS

73,000 CFM
17" WG

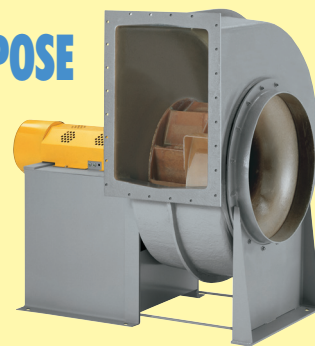

THE BEST FRP FANS STILL KEEP COMING FROM NEW YORK BLOWER!