



WUXI CHIU CHAU ENVIRONMENTAL  
PROTECTION EQUIPMENT CO.,LTD

**SAF-A**

SAF-A(CN) July 2024

**Airfoil Centrifugal Impeller**



Wuxi Chiu Chau Environmental Protection Equipment Co.,Ltd certifies that the SAF-A Airfoil Centrifugal Fan shown herein are licensed to bear the AMCA Seal. The ratings shown are based on tests and procedures performed in accordance with AMCA Publication 211 and AMCA Publication 311 and comply with the requirements of the AMCA Certified Ratings Program.

**Quality Reputation Service**

# Prospectus

---

Idea of operation: Prime in authentication, everlasting operation

Quality policy: Good quality, customer satisfaction

In the beginning of this instruction, first we thank for the support given from all parties, we always keep good contact with old customers and exploit new market aggressively, realize continue, stable and coordinate development. The agreement contracted, proceeds, income after taxed both create peak in history. In order to affirm the foundation, we passed ISO 9001 quality management system accreditation. We prime the motto of “authentication, everlasting operation, good quality, customer satisfaction” as subject of national economy, providing first class product to society.

## Product Feature

---

- Production equipment: dynamic balance calibration unit, hydraulic bending bed, hydraulic shear, level lathe, plasma cutting unit, CO2 electric welding set screw press, Argon welding set.
- Testing equipment: spectrum analyzer, laser aiming unit, thermal linear anemometer, noise decibel gauge, U tube, electronic pressure gauge, thermometer, tachometer, Pitot tube, diaphragm gauge, caliper.
- Education & training: monthly fixed 4 hours on-job training, invited professional lecturer, the contents of the program include professional know-how, production management, quality control and so on. Two or three persons are selected to attend visit and practice in academic unit yearly.
- Quality control: meet ISO 9001 quality management system.
- After sale service and handling of customer complaint: We provide customer service and maintenance service department exclusive for requirement of after sale service and handling of emergency incident., proceed subject to each customer complaint case, failure determination, cause analysis, trouble shooting, case classification and management. Cope with periodical maintenance of the user yearly.



# Wuxi Chiu Chau Environmental Protection Equipment Co., Ltd.



## SAF-A Series



- This is improved turbine model, high efficiency and fixed load, resist to motor overload, with lowest noise in all model Applicable in ordinary ventilation such as air conditioned of common office building, air delivery of various kiln.
- Max air volume up to 100000 CFM.
- Max. static pressure up to 30 inwg.

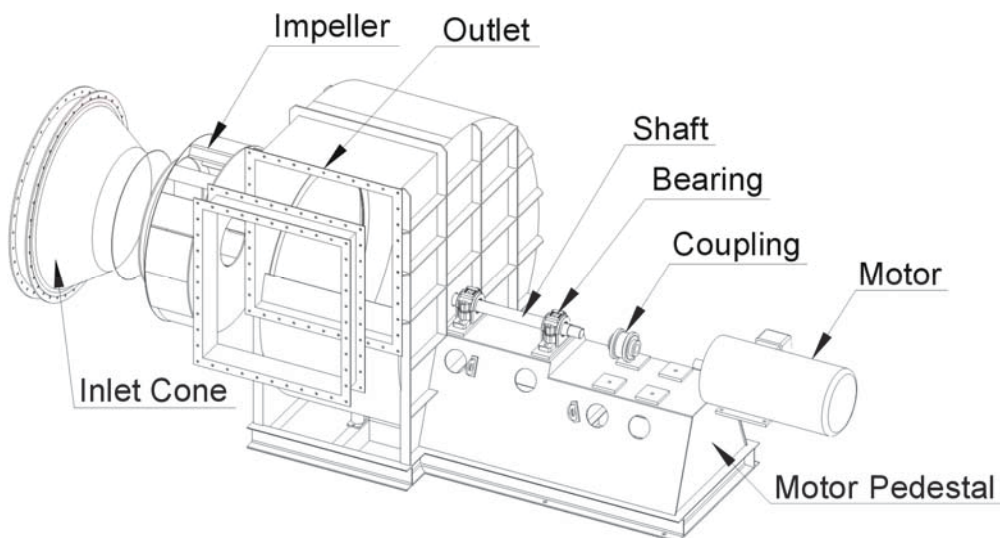

# Example of Fan Curve Reading

## SAF-A-16.5 (Inlet Sound Power)

**Air Flowrate** Q=2.005 CMS  
**Outlet Velocity** V=7.64 m/s  
**Total Pressure** Pt=1553 Pa  
**Velocity Pressure** Pv=93 Pa  
**Static Pressure** Ps=1460 Pa  
**Fan Speed** N=2700 rpm  
**Fan Shaft Power** W=4.124 kW  
**Sound Power** LwiA=88 dB(A)  
**Total Efficiency**  $\eta$ =74.9%

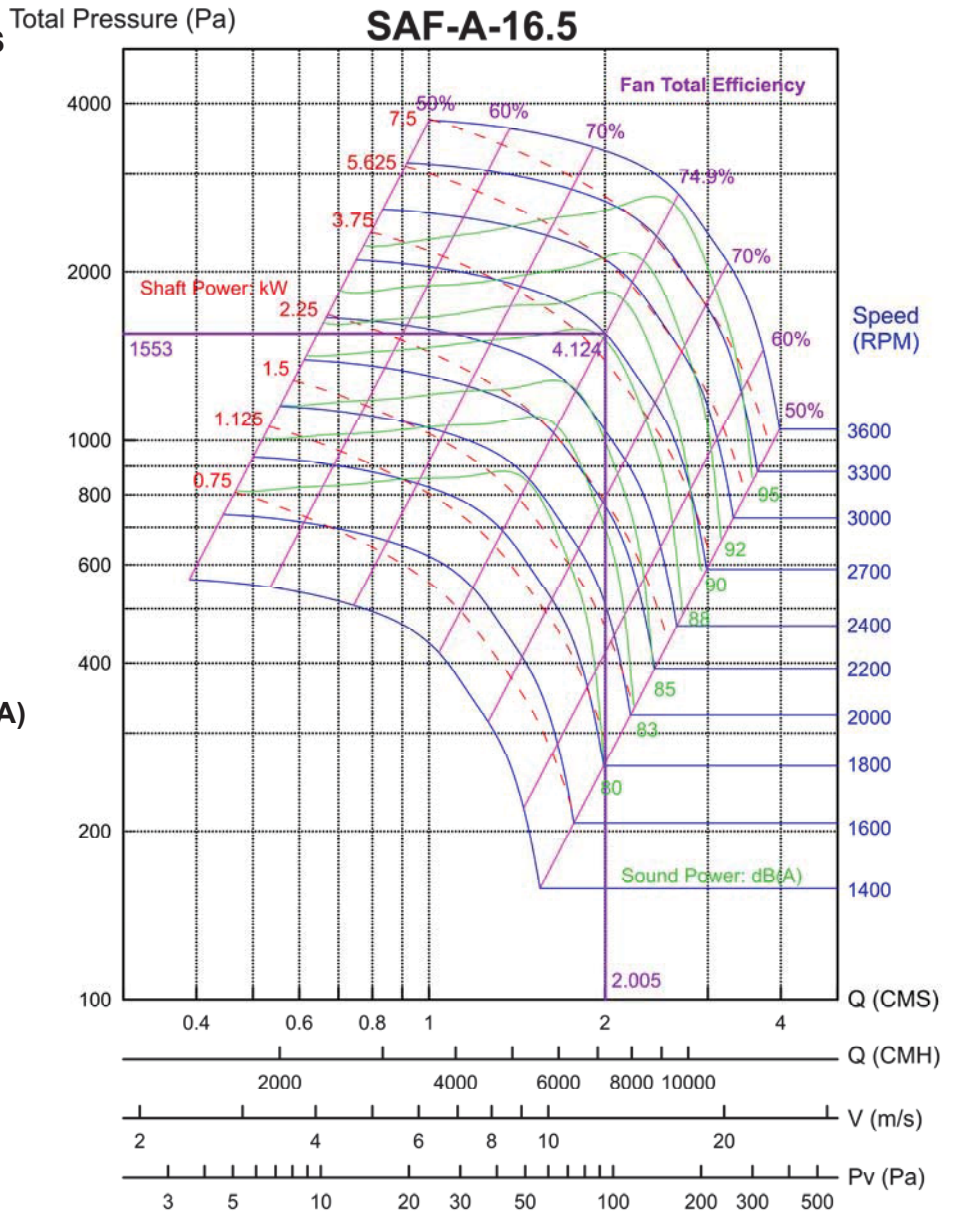

Performance certified is for Installation Type B, free inlet, ducted outlet. Power rating (kW) does not include transmission losses. Performance ratings do not include the effects of appurtenances (accessories). The A-weighted sound ratings shown have been calculated per AMCA International Standard 301. Values shown are for inlet LwiA sound power levels for Installation Type B: free inlet, ducted outlet.

Total Pressure (Pa)

# SAF-A-16.5



FEG 80

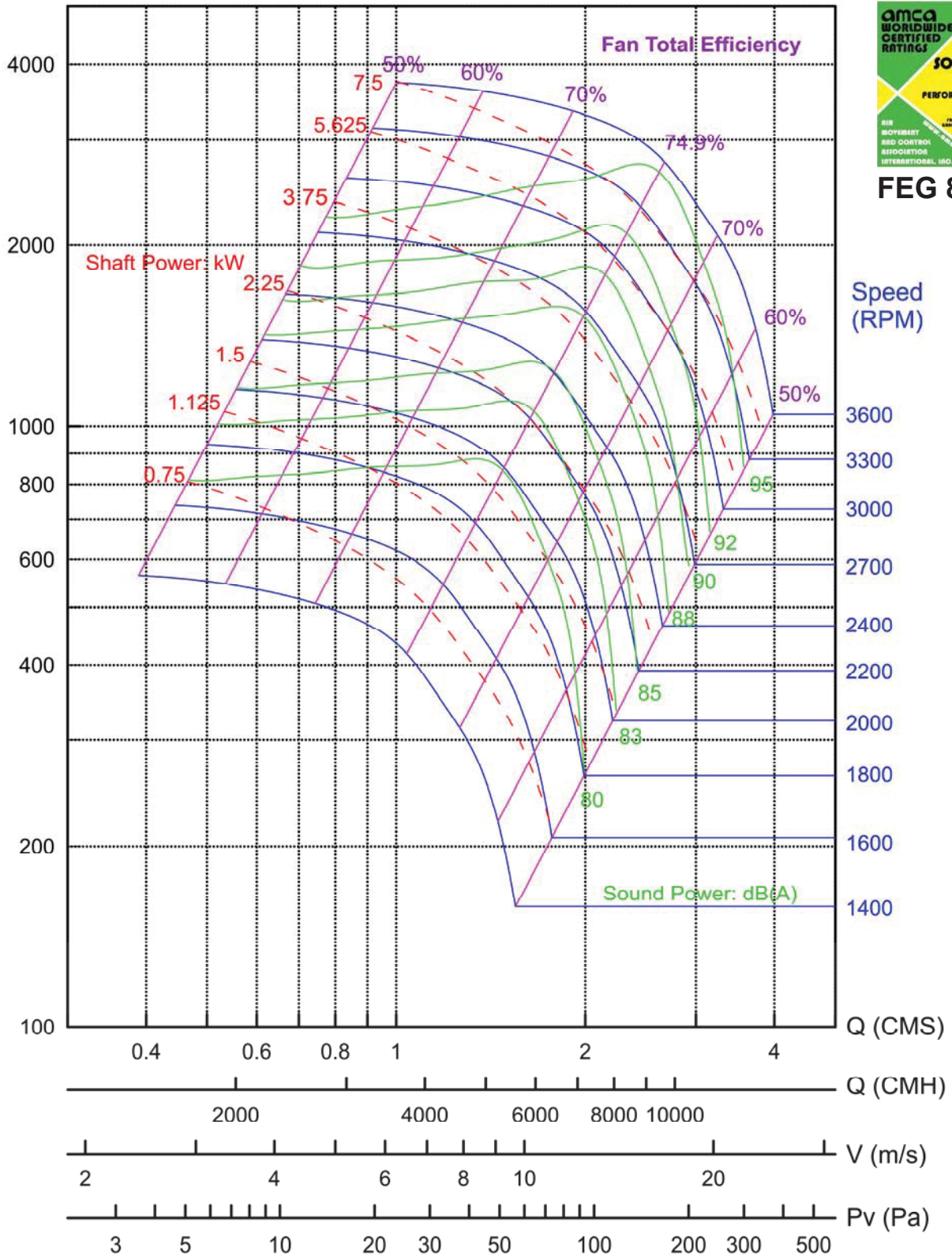

Performance certified is for Installation Type B, free inlet, ducted outlet. Power rating (kW) does not include transmission losses. Performance ratings do not include the effects of appurtenances (accessories). The A-weighted sound ratings shown have been calculated per AMCA International Standard 301. Values shown are for inlet LwiA sound power levels for Installation Type B: free inlet, ducted outlet.

Total Pressure (Pa)

# SAF-A-18.25

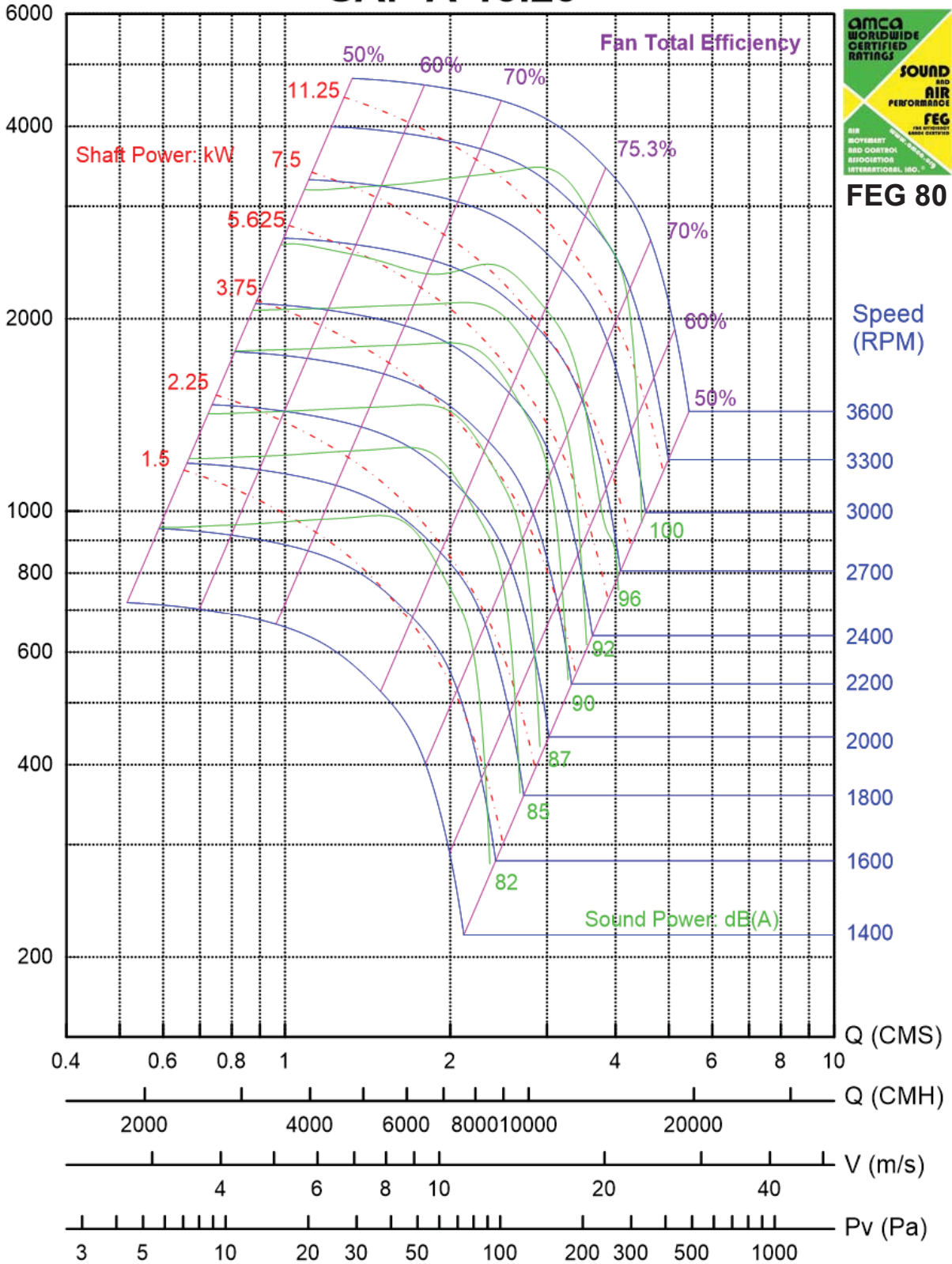

Performance certified is for Installation Type B, free inlet, ducted outlet. Power rating (kW) does not include transmission losses. Performance ratings do not include the effects of appurtenances (accessories). The A-weighted sound ratings shown have been calculated per AMCA International Standard 301. Values shown are for inlet LwIA sound power levels for Installation Type B: free inlet, ducted outlet.

Total Pressure (Pa)

# SAF-A-20

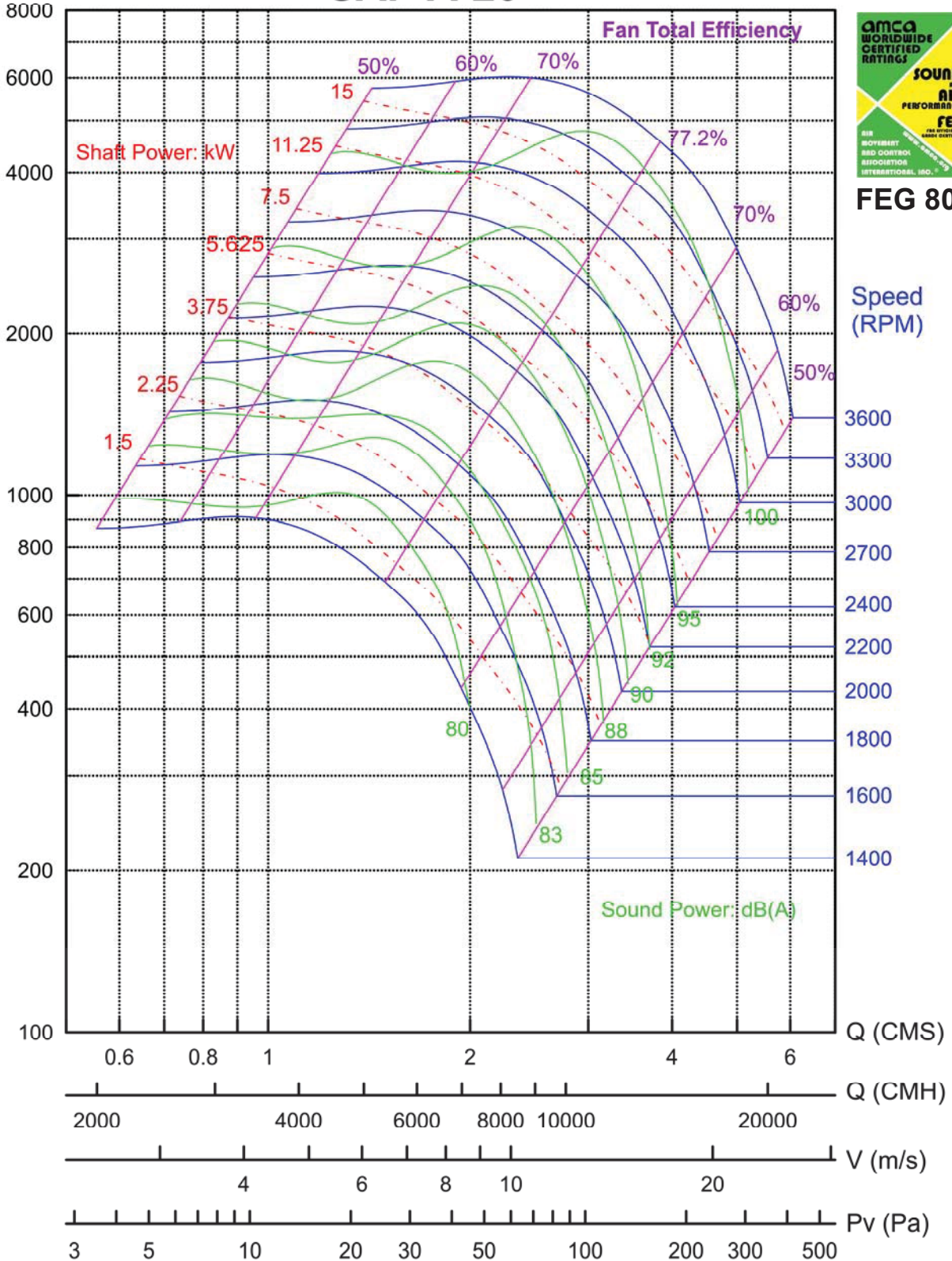

FEG 80

Speed (RPM)

Performance certified is for Installation Type B, free inlet, ducted outlet. Power rating (kW) does not include transmission losses. Performance ratings do not include the effects of appurtenances (accessories). The A-weighted sound ratings shown have been calculated per AMCA International Standard 301. Values shown are for inlet LwIA sound power levels for Installation Type B: free inlet, ducted outlet.

Total Pressure (Pa)

# SAF-A-22.25

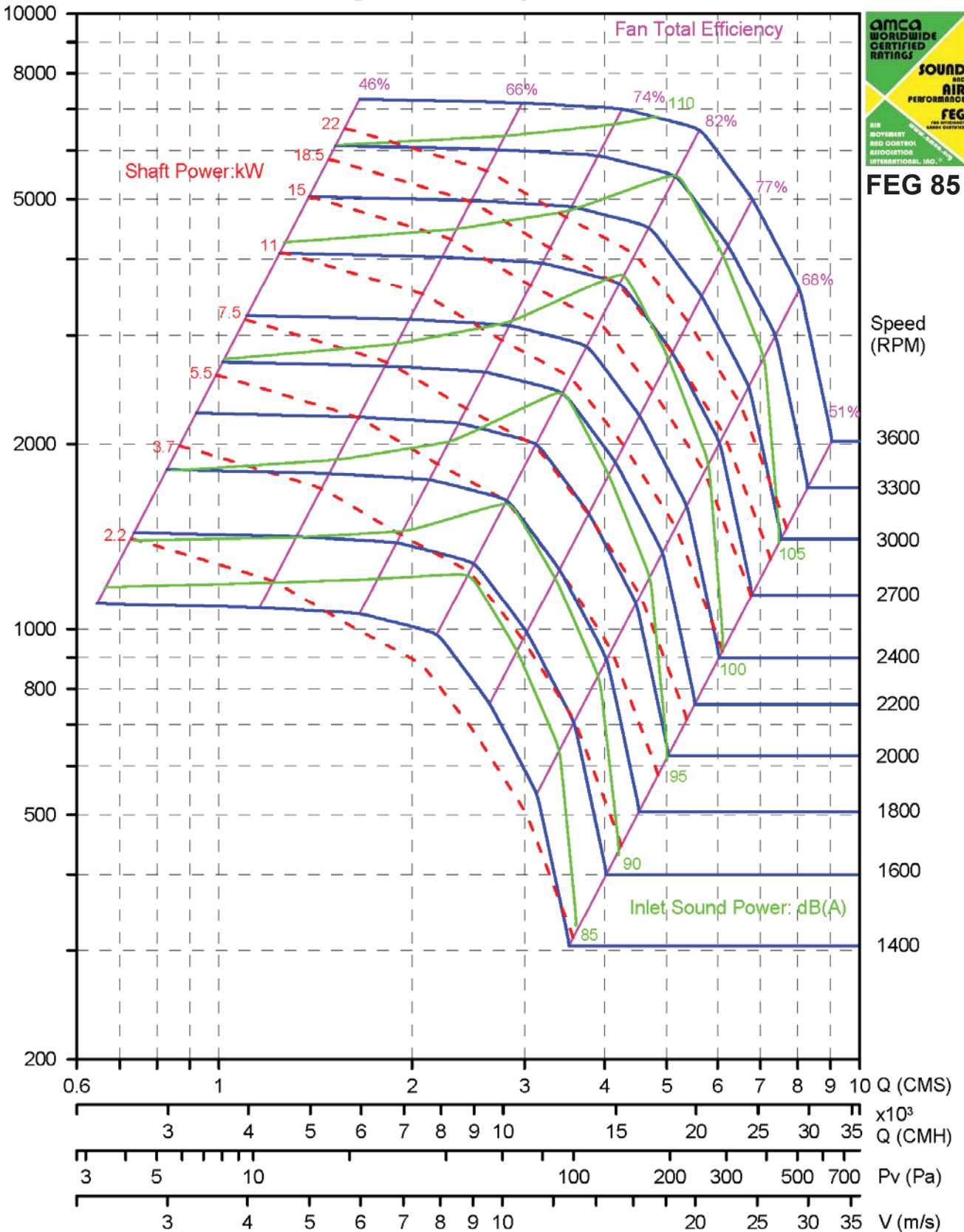

FEG 85

Performance certified is for Installation Type B, free inlet, ducted outlet. Power rating (kW) does not include transmission losses. Performance ratings do not include the effects of appurtenances (accessories). The A-weighted sound ratings shown have been calculated per AMCA International Standard 301. Values shown are for inlet LwA sound power levels for Installation Type B: free inlet, ducted outlet.



Total Pressure (Pa)

# SAF-A-24.5

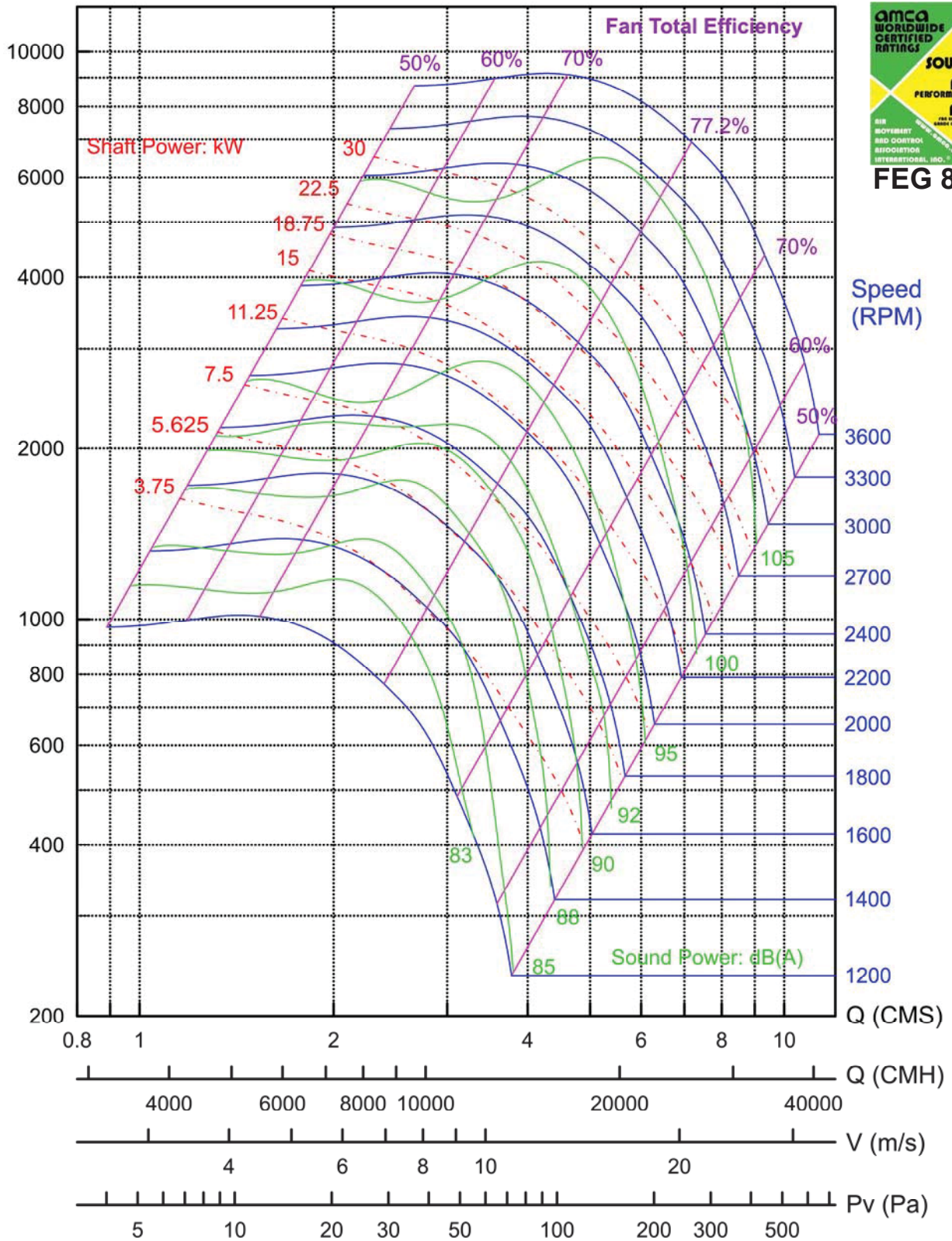

Performance certified is for Installation Type B, free inlet, ducted outlet. Power rating (kW) does not include transmission losses. Performance ratings do not include the effects of appurtenances (accessories). The A-weighted sound ratings shown have been calculated per AMCA International Standard 301. Values shown are for inlet LwiA sound power levels for Installation Type B: free inlet, ducted outlet.

Total Pressure (Pa)

# SAF-A-27

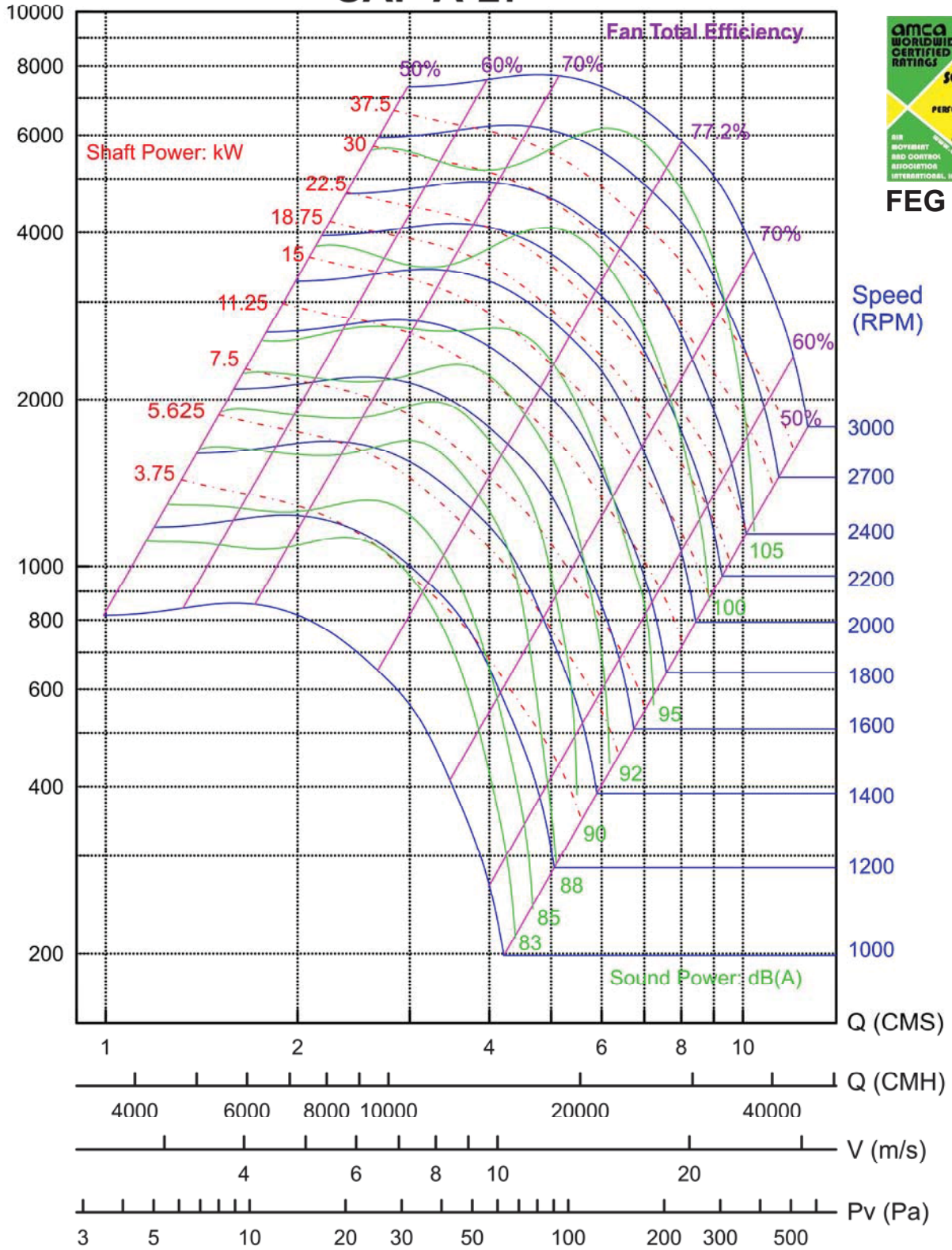

Performance certified is for Installation Type B, free inlet, ducted outlet. Power rating (kW) does not include transmission losses. Performance ratings do not include the effects of appurtenances (accessories). The A-weighted sound ratings shown have been calculated per AMCA International Standard 301. Values shown are for inlet LwIA sound power levels for Installation Type B: free inlet, ducted outlet.

Total Pressure (Pa)

# SAF-A-30

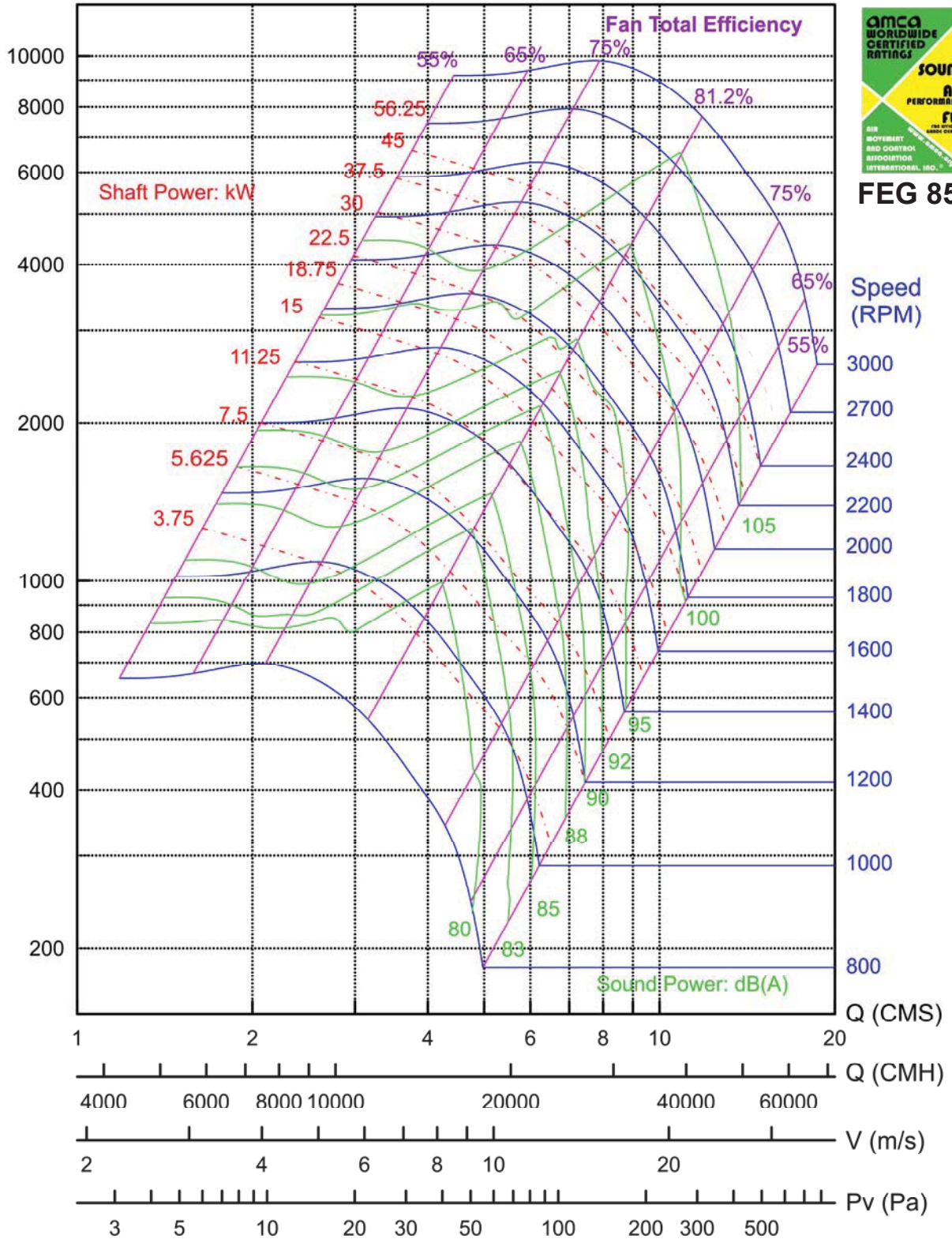

FEG 85

Performance certified is for Installation Type B, free inlet, ducted outlet. Power rating (kW) does not include transmission losses. Performance ratings do not include the effects of appurtenances (accessories). The A-weighted sound ratings shown have been calculated per AMCA International Standard 301. Values shown are for inlet LwIA sound power levels for Installation Type B: free inlet, ducted outlet.

Total Pressure (Pa)

# SAF-A-33

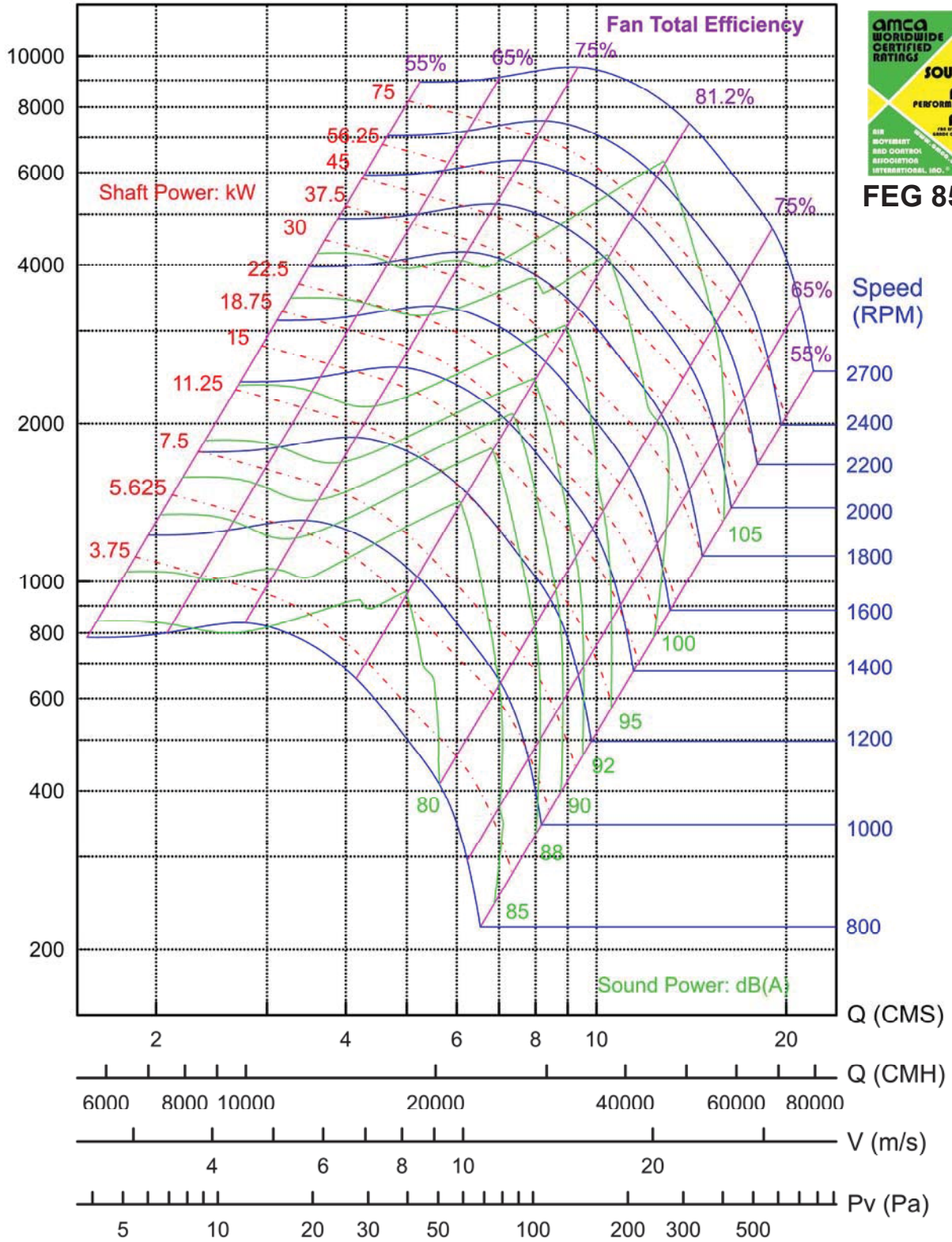

Performance certified is for Installation Type B, free inlet, ducted outlet. Power rating (kW) does not include transmission losses. Performance ratings do not include the effects of appurtenances (accessories). The A-weighted sound ratings shown have been calculated per AMCA International Standard 301. Values shown are for inlet LwIA sound power levels for Installation Type B: free inlet, ducted outlet.

Total Pressure (Pa)

# SAF-A-36.5

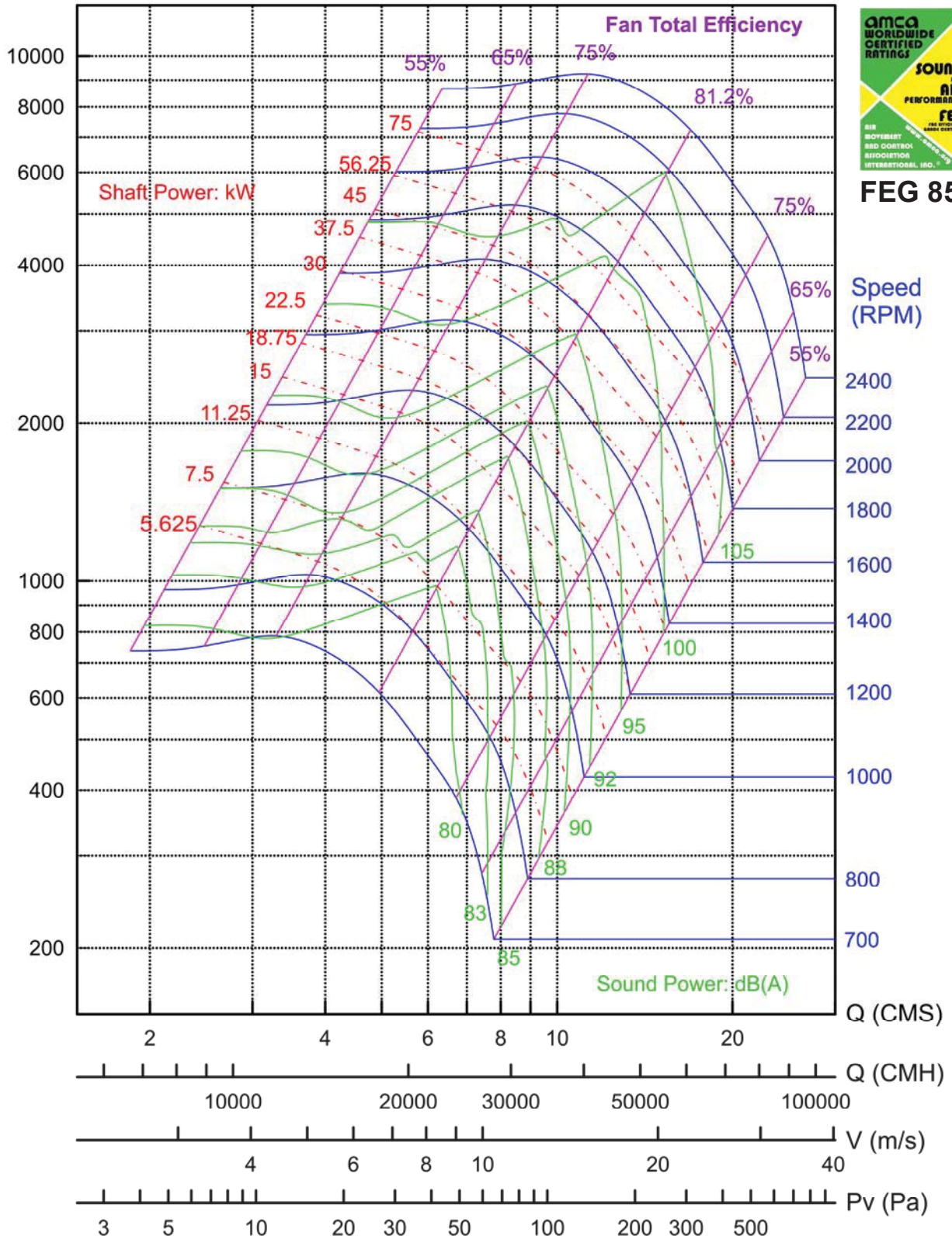

FEG 85

Performance certified is for Installation Type B, free inlet, ducted outlet. Power rating (kW) does not include transmission losses. Performance ratings do not include the effects of appurtenances (accessories). The A-weighted sound ratings shown have been calculated per AMCA International Standard 301. Values shown are for inlet LwiA sound power levels for Installation Type B: free inlet, ducted outlet.

Total Pressure (Pa)

# SAF-A-40.25

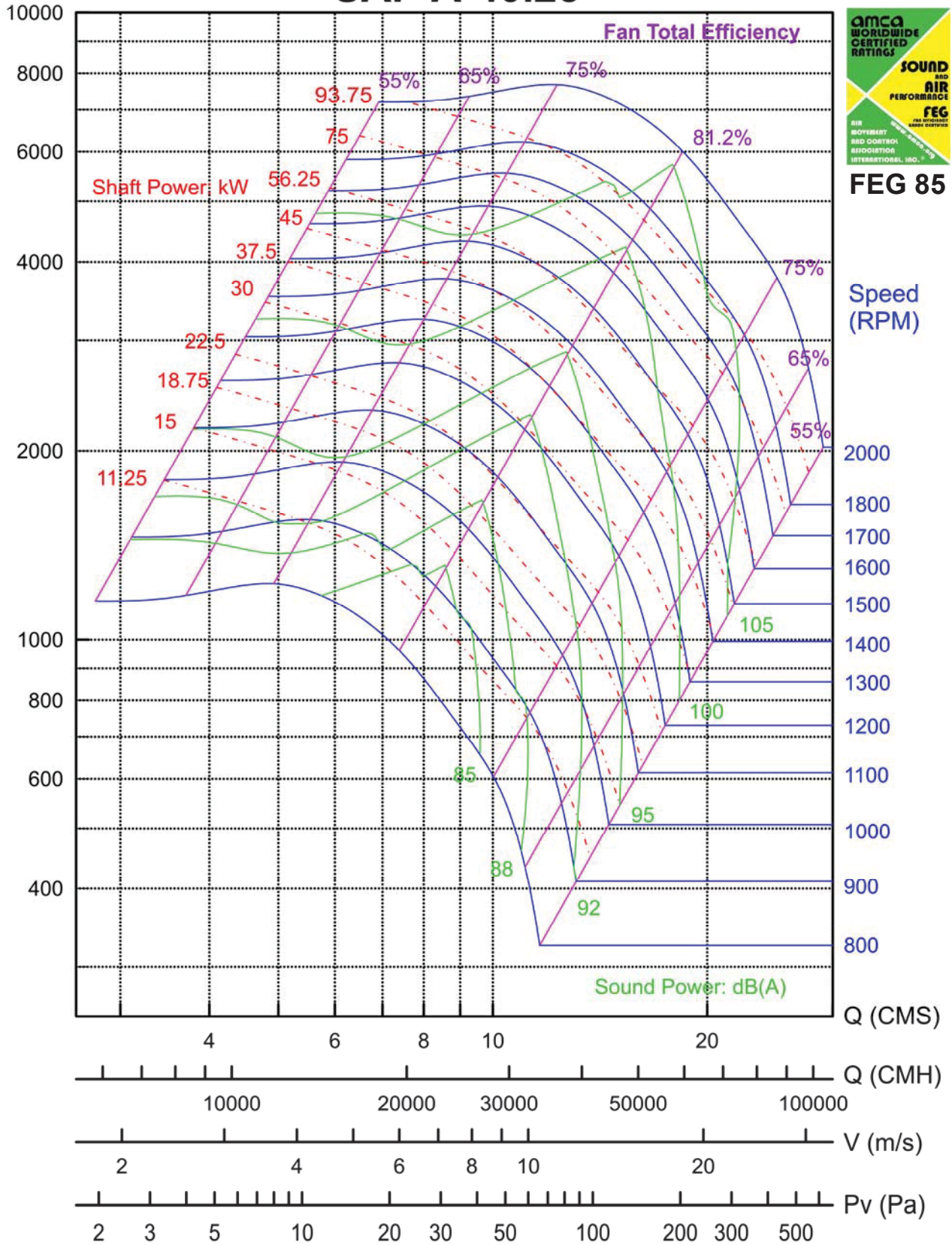

Performance certified is for Installation Type B, free inlet, ducted outlet. Power rating (kW) does not include transmission losses. Performance ratings do not include the effects of appurtenances (accessories). The A-weighted sound ratings shown have been calculated per AMCA International Standard 301. Values shown are for inlet LwiA sound power levels for Installation Type B: free inlet, ducted outlet.

Total Pressure (Pa)

# SAF-A-44.5

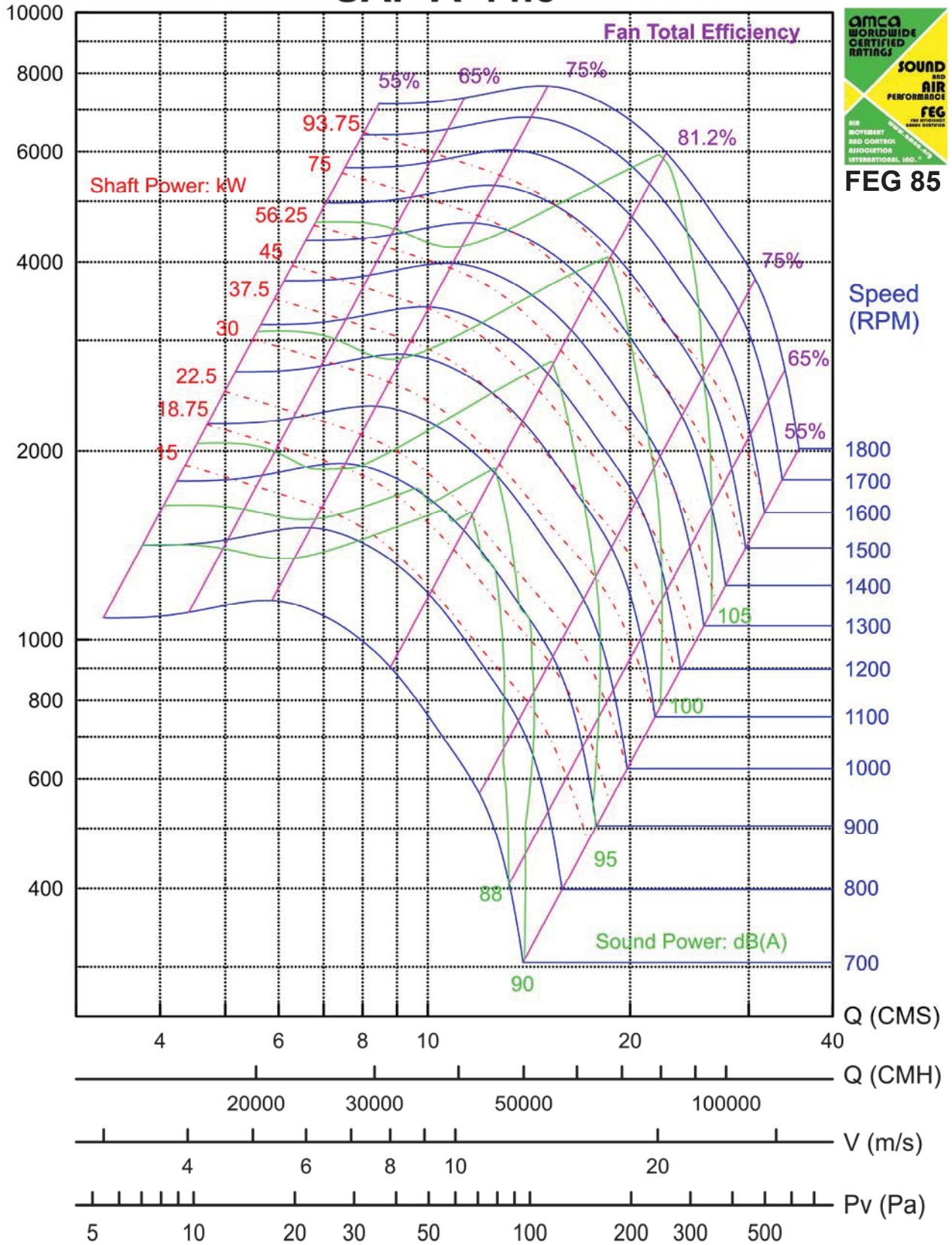

Speed  
(RPM)

1800  
1700  
1600  
1500  
1400  
1300  
1200  
1100  
1000  
900  
800  
700

Q (CMS)  
Q (CMH)  
V (m/s)  
Pv (Pa)

Performance certified is for Installation Type B, free inlet, ducted outlet. Power rating (kW) does not include transmission losses. Performance ratings do not include the effects of appurtenances (accessories). The A-weighted sound ratings shown have been calculated per AMCA International Standard 301. Values shown are for inlet LwIA sound power levels for Installation Type B: free inlet, ducted outlet.

Total Pressure (Pa)

# SAF-A-49

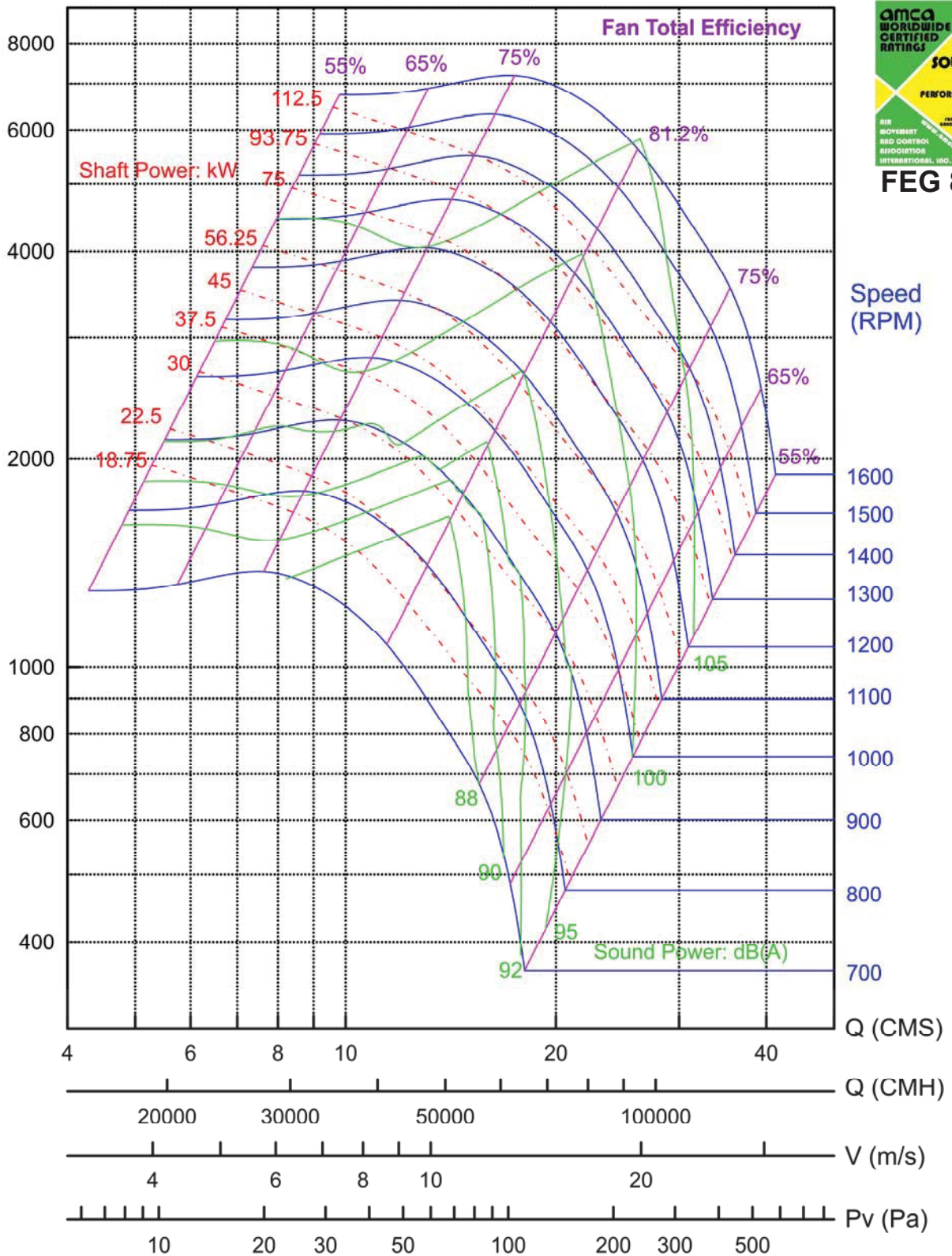

Performance certified is for Installation Type B, free inlet, ducted outlet. Power rating (kW) does not include transmission losses. Performance ratings do not include the effects of appurtenances (accessories). The A-weighted sound ratings shown have been calculated per AMCA International Standard 301. Values shown are for inlet LwIA sound power levels for Installation Type B: free inlet, ducted outlet.



Total Pressure (Pa)

# SAF-A-54.25

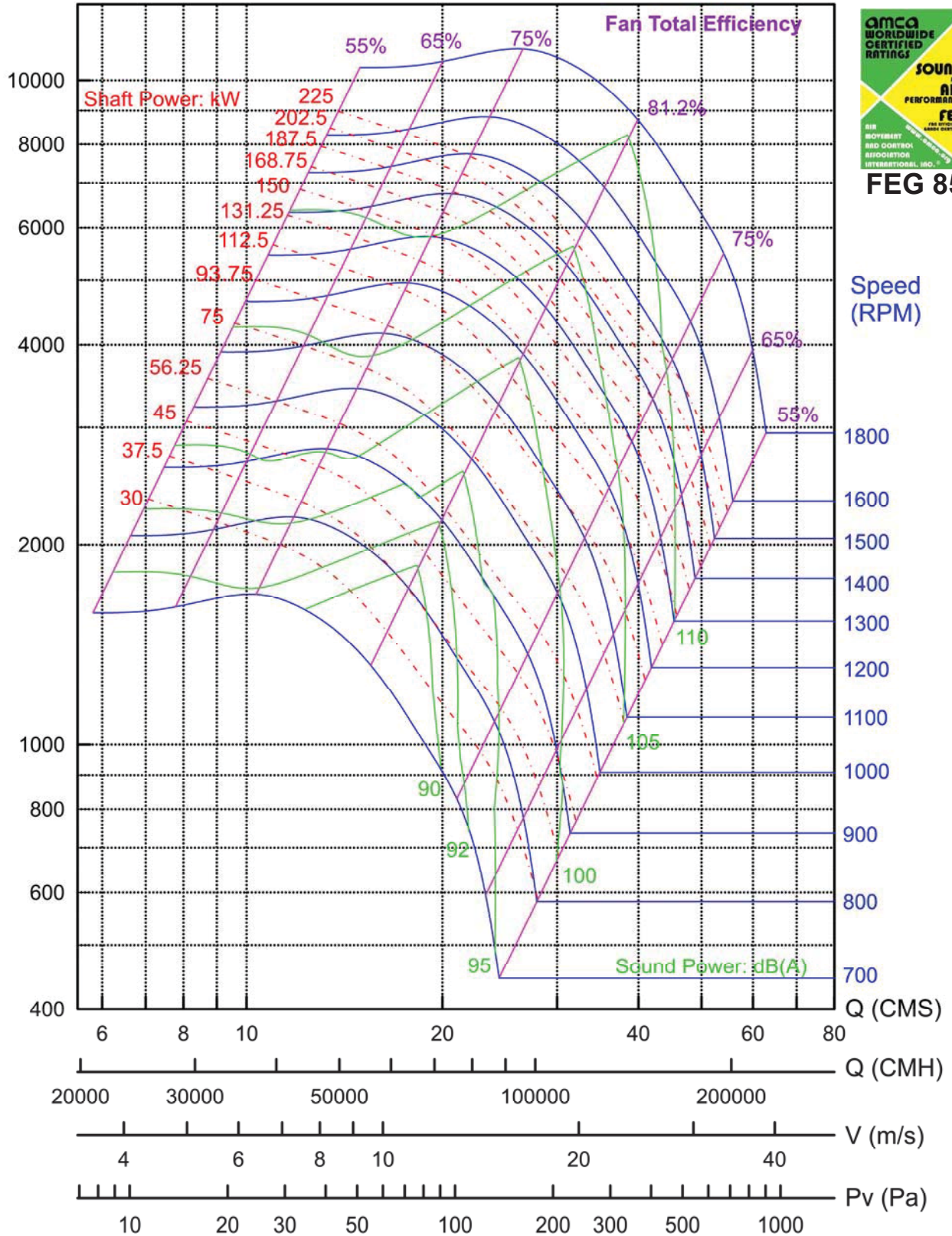

Performance certified is for Installation Type B, free inlet, ducted outlet. Power rating (kW) does not include transmission losses. Performance ratings do not include the effects of appurtenances (accessories). The A-weighted sound ratings shown have been calculated per AMCA International Standard 301. Values shown are for inlet LwIA sound power levels for Installation Type B: free inlet, ducted outlet.

Total Pressure (Pa)

# SAF-A-60

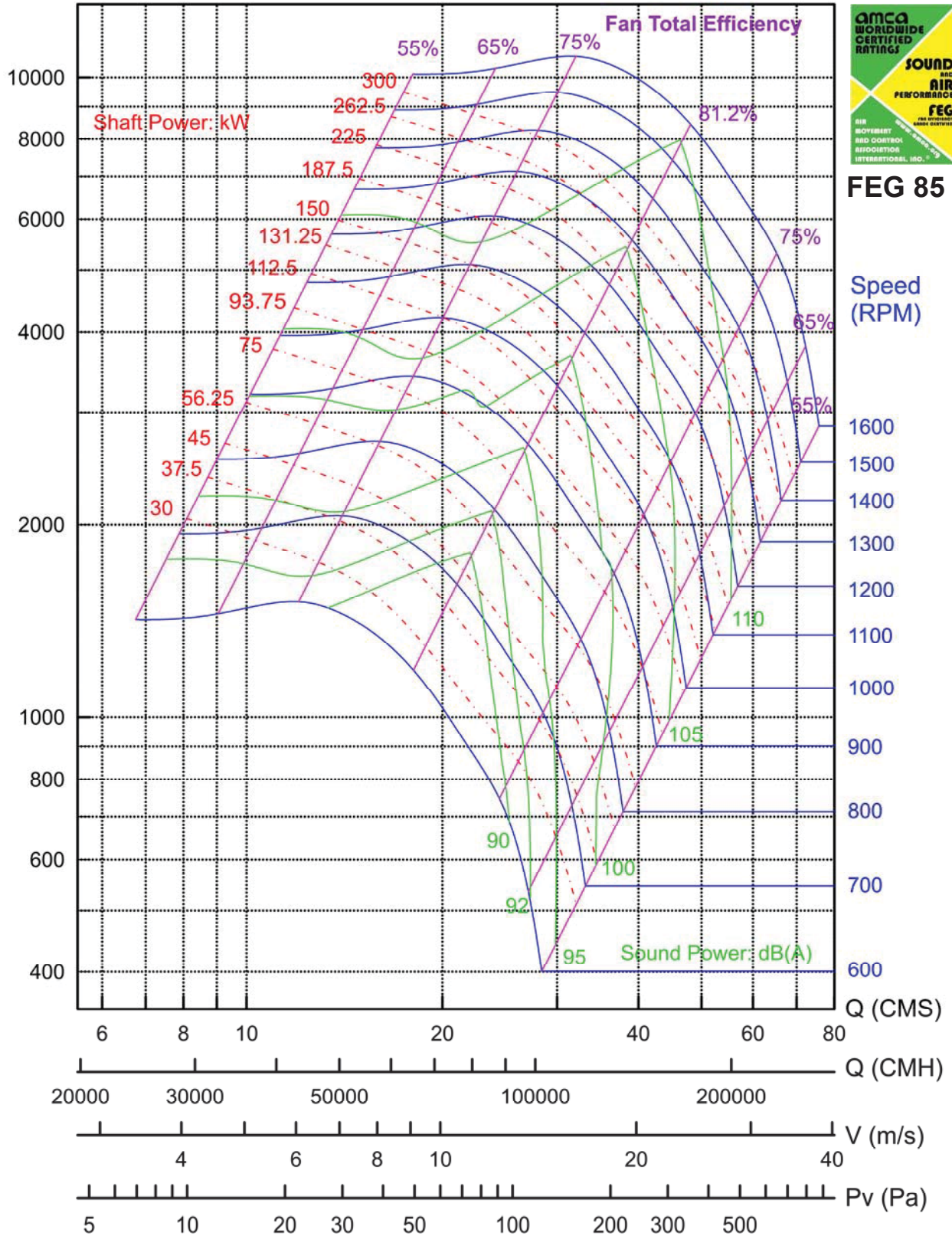

FEG 85

Speed (RPM)

1600  
1500  
1400  
1300  
1200  
1100  
1000  
900  
800  
700  
600

Q (CMS)  
Q (CMH)  
V (m/s)  
Pv (Pa)

Performance certified is for Installation Type B, free inlet, ducted outlet. Power rating (kW) does not include transmission losses. Performance ratings do not include the effects of appurtenances (accessories). The A-weighted sound ratings shown have been calculated per AMCA International Standard 301. Values shown are for inlet LwiA sound power levels for Installation Type B: free inlet, ducted outlet.

Total Pressure (Pa)

# SAF-A-66

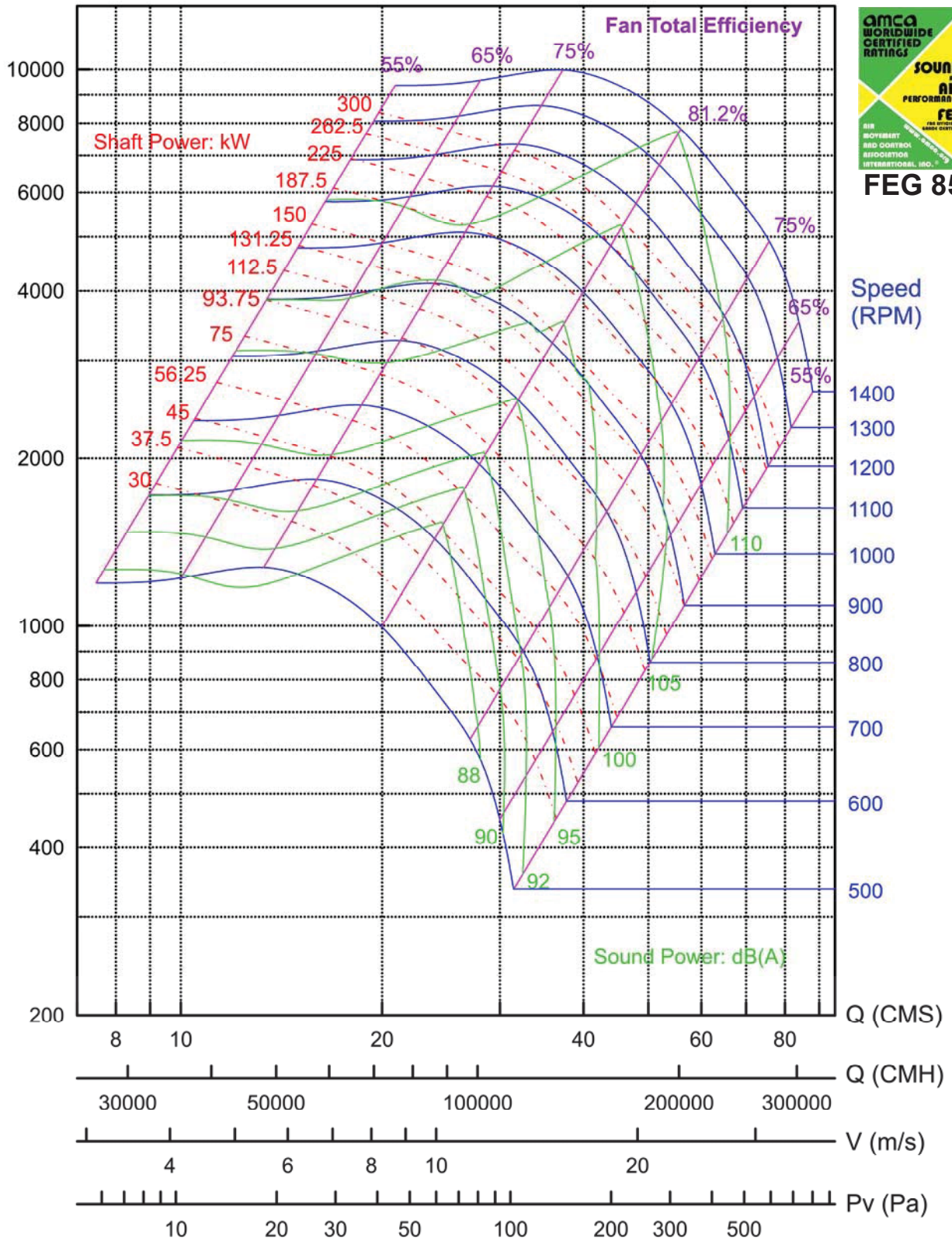

Performance certified is for Installation Type B, free inlet, ducted outlet. Power rating (kW) does not include transmission losses. Performance ratings do not include the effects of appurtenances (accessories). The A-weighted sound ratings shown have been calculated per AMCA International Standard 301. Values shown are for inlet LwiA sound power levels for Installation Type B: free inlet, ducted outlet.



# Wuxi Chiu Chau Environmental Protection Equipment Co., Ltd.

## Fan Dimension

### SAF-A

16.5/18.25/20/22.25/24.5/27/30/33/36.5/40.25/44.5/49/54.25/60/66

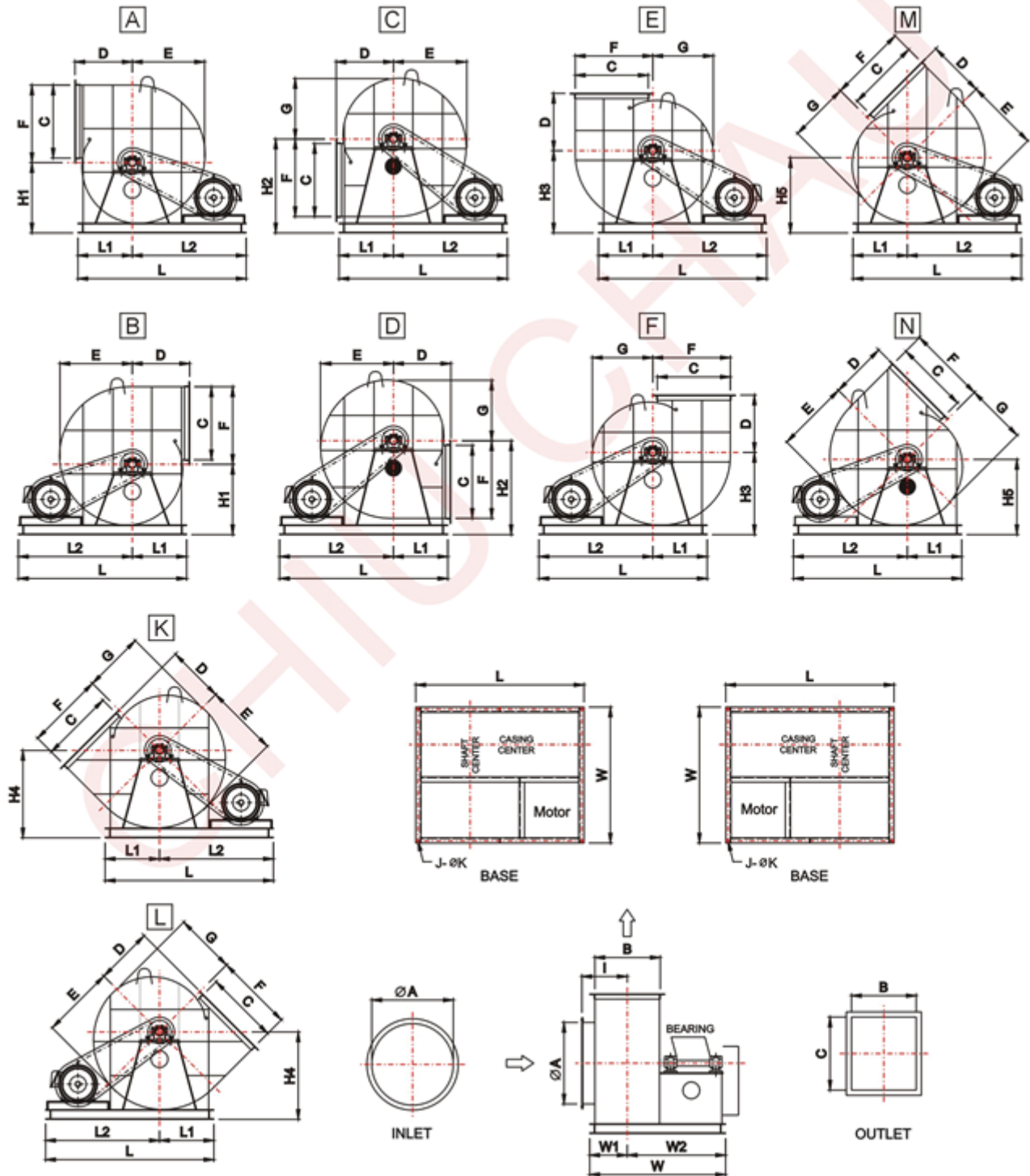



# Wuxi Chiu Chau Environmental Protection Equipment Co., Ltd.

## Fan Dimension

### SAF-A

16.5/18.25/20/22.25/24.5/27/30/33/36.5/40.25/44.5/49/54.25/60/66

### Dimension List

Model	Inlt	Oult		Body					Center Height					*Base	
	$\phi$ A	B	C	D	E	F	G	I	H1	H2	H3	H4	H5	J*	$\phi$ K*
<b>16.5</b>	480	370	420	360	408	457	358	285	408	550	458	482	433	6	15
<b>18.25</b>	530	410	465	405	448	505	392	305	457	620	513	542	485	6	15
<b>20</b>	580	445	505	440	493	552	432	325	497	675	558	587	527	6	15
<b>22.25</b>	640	495	560	443	559	599	468	350	543	720	635	675	580	6	15
<b>24.5</b>	710	550	625	488	616	620	515	375	590	780	690	735	630	8	15
<b>27</b>	785	602	685	537	678	728	567	400	667	870	778	740	630	8	15
<b>30</b>	850	670	760	597	755	809	630	435	730	970	855	820	700	8	15 / 19
<b>33</b>	930	740	830	635	830	889	692	470	792	1065	930	900	770	8	15 / 19
<b>36.5</b>	1030	810	920	699	915	982	764	505	780	1165	1040	1000	850	8	19
<b>40.25</b>	1130	890	1010	768	1007	1081	841	570	860	1280	1132	1100	930	8	19
<b>44.5</b>	1250	990	1110	900	1074	1208	939	620	960	1440	1100	1160	1030	8	22
<b>49</b>	1380	1085	1220	970	1182	1330	1033	695	1055	1570	1210	1280	1130	8	22
<b>54.25</b>	1520	1200	1350	1100	1037	1470	1145	750	1170	1720	1330	1420	1250	8	22
<b>60</b>	1680	1330	1490	1150	1444	1624	1264	815	1446	1856	1625	1716	1536	10	24
<b>66</b>	1850	1460	1650	1300	1588	1786	1390	880	1590	2136	1788	1887	1690	12	24

Model	*Base					
	L*	L1*	L2*	W*	W1*	W2*
<b>16.5</b>	1150	340	810	855	235	620
<b>18.25</b>	1180	385	795	1020	270	750
<b>20</b>	1380	415	965	1065	290	775
<b>22.25</b>	1350	420	930	1100	290	810
<b>24.5</b>	1500	460	1040	1200	325	875
<b>27</b>	1600	500	1100	1300	350	950
<b>30</b>	1750	565	1185	1450	400	1050
<b>33</b>	1800	605	1195	1550	435	1115

Model	*Base					
	L*	L1*	L2*	W*	W1*	W2*
<b>36.5</b>	2000	665	1335	1700	470	1230
<b>40.25</b>	2150	715	1435	1800	510	1290
<b>44.5</b>	2550	795	1755	1970	570	1400
<b>49</b>	2700	855	1845	2060	620	1440
<b>54.25</b>	2900	935	1965	2180	675	1505
<b>60</b>	3000	1015	1985	2500	740	1760
<b>66</b>	3100	1100	2000	2700	805	1895

\*\*\* could be altered due to different motor size



# Wuxi Chiu Chau Environmental Protection Equipment Co., Ltd.

## Technology Data

### ● Drive Type:

Coupling Drive

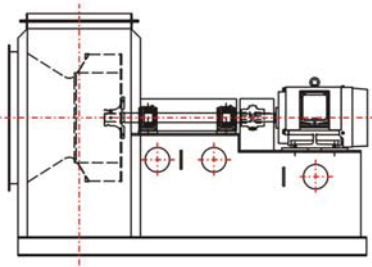

Belt Drive

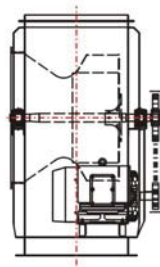

Motor Drive

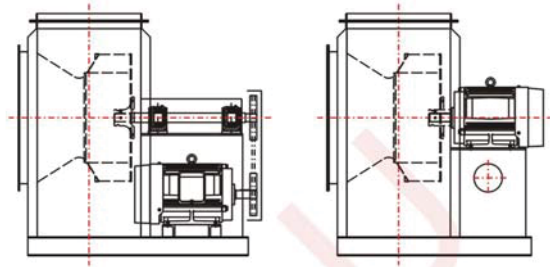

### ● Rotating Orientation:

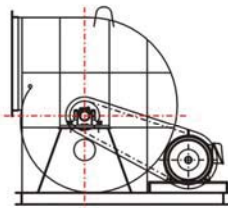

A Counter-Clockwise Top Horizontal

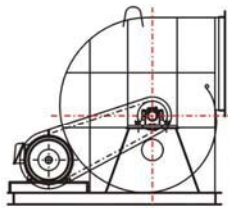

B Clockwise Top Horizontal

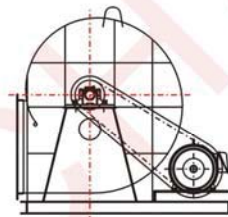

C Clockwise Bottom Horizontal

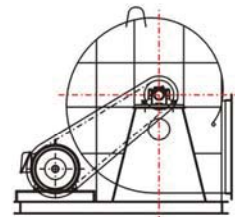

D Counter-Clockwise Bottom Horizontal

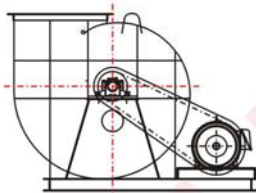

E Clockwise Up Blast

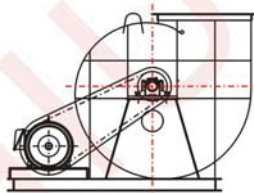

F Counter-Clockwise Up Blast

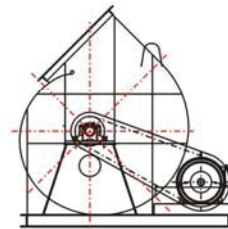

M Counter-Clockwise Top Angular Up

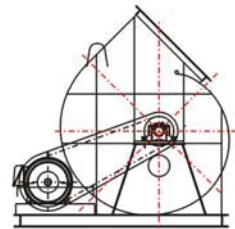

N Clockwise Top Angular Up

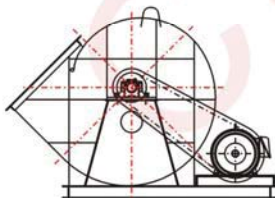

K Clockwise Bottom Angular Up

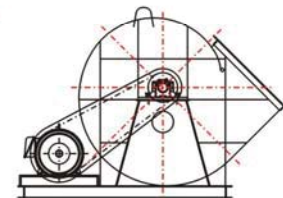

L Counter-Clockwise Bottom Angular Up

- Please faces the pulley or motor to decide the orientation.
- Additionally, made the orientation of the client freely.



## WUXI CHIU CHAU ENVIRONMENTAL PROTECTION EQUIPMENT CO.,LTD

Head Office: No. 233 A South Chengnan Road, New District, Wuxi, Jiangsu,China

Tel: 0510-88550351 Fax: 0510-88550350

Email: c.c.fan@wxchiuchau.com

Http:// www.wxchiuchau.com