



(주) 태일송풍기  
TAE IL BLOWER MFG. Co.,Ltd.

**TDRD**

**DOUBLE INLET CENTRIFUGAL FAN with BACKWARD WHEELS**



# Backward Double Inlet Centrifugal Fan TDRD Series



Tae il Blower Mfg. Co., LTD certifies that the TDRD Series shown herein are licensed to bear the AMCA Seal. The ratings shown are based on tests and procedures performed in accordance with AMCA Publication 211 and AMCA Publication 311 and comply with the requirements of the AMCA Certified Ratings Program.



TDRD Series는 AMCA 인증 제품입니다.

BackWard Type의 양흡입 원심팬으로 150 ~ 250 mmAq의 정압에서 많은 풍량을 요구하는 경우 사용되는 제품입니다.

중앙집중 냉/난방설비에 주로 사용되며, 강제 급/배기, 집진, 제진 등의 설비에 사용됩니다.



# Backward Double Inlet Centrifugal Fan

# TDRD Series

## 1. 표준 외형도

Standard Shape of Backward Double Inlet Centrifugal Fan

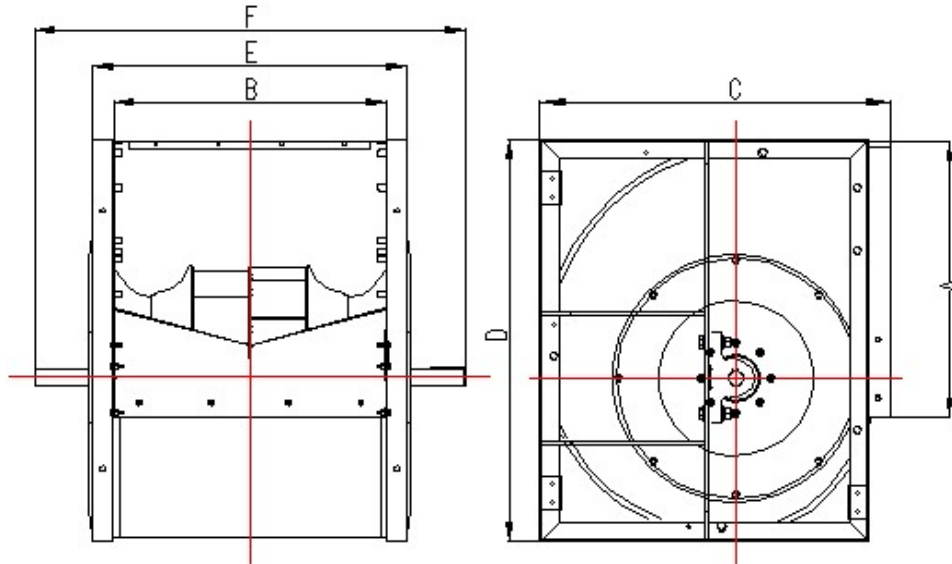

## 2. Fan 치수표

NO	Model Name	Wheel Dia.	A	B	C	D	E	F
1	TDRD-355	355	453	453	578	655	533	725
2	TDRD-400	400	507	507	651	736	587	790
3	TDRD-450	450	569	569	726	827	649	890
4	TDRD-500	500	638	638	800	918	718	960
5	TDRD-560	560	715	715	893	1030	815	1070
6	TDRD-630	630	801	801	999	1157	901	1155
7	TDRD-710	710	898	898	1121	1303	998	1290
8	TDRD-800	800	1007	1007	1250	1468	1107	1450
9	TDRD-900	900	1130	1130	1408	1648	1250	1570
10	TDRD-1000	1000	1267	1267	1541	1810	1387	1700



Wheel dia. 355 mm Tip Speed 0.0186 × rpm Outlet Dim. 453 × 453 Outlet Area 0.2052 m<sup>2</sup> Class 1 3228 rpm Class 2 4304 rpm Not Applicable

Det.	N	Pt	Ps	Q	H	EtaT	EtaS	Lwi	Det.	N	Pt	Ps	Q	H	EtaT	EtaS	Lwi
	[r/min]	[Pa]	[Pa]	[m <sup>3</sup> /min]	[kW]	[%]	[%]	[dB(A)]		[r/min]	[Pa]	[Pa]	[m <sup>3</sup> /min]	[kW]	[%]	[%]	[dB(A)]
1	1000	61	38	75.0	0.225	33.9	21.3	82	1	1200	88	55	90.0	0.389	33.9	21.3	86
2		101	84	65.7	0.225	49.3	40.8	79	2		146	121	78.9	0.389	49.3	40.8	84
3		135	121	58.2	0.222	58.8	52.8	77	3		194	174	69.9	0.384	58.8	52.8	82
4		164	154	50.7	0.215	64.3	60.2	76	4		236	221	60.9	0.372	64.3	60.2	81
5		193	186	41.9	0.202	66.5	64.0	75	5		278	267	50.3	0.349	66.5	64.0	79
6		217	212	32.6	0.184	63.9	62.7	74	6		312	306	39.1	0.317	63.9	62.7	79
7		218	215	25.1	0.158	57.4	56.7	74	7		313	310	30.1	0.274	57.4	56.7	79
1	1400	120	75	104.9	0.617	33.9	21.3	89	1	1600	156	98	119.9	0.922	33.9	21.3	93
2		199	165	92.0	0.618	49.3	40.8	87	2		260	215	105.2	0.922	49.3	40.8	90
3		264	237	81.5	0.609	58.8	52.8	85	3		345	310	93.2	0.909	58.8	52.8	88
4		321	301	71.0	0.590	64.3	60.2	84	4		420	393	81.2	0.881	64.3	60.2	88
5		378	364	58.7	0.554	66.5	64.0	83	5		493	475	67.1	0.827	66.5	64.0	86
6		425	416	45.6	0.504	63.9	62.7	82	6		555	544	52.2	0.752	63.9	62.7	86
7		426	421	35.2	0.435	57.4	56.7	82	7		557	550	40.2	0.649	57.4	56.7	86
1	1800	198	124	134.9	1.312	33.9	21.3	95	1	2000	244	153	149.9	1.800	33.9	21.3	98
2		329	272	118.3	1.313	49.3	40.8	93	2		406	336	131.4	1.802	49.3	40.8	96
3		437	392	104.8	1.295	58.8	52.8	91	3		539	484	116.5	1.776	58.8	52.8	94
4		531	498	91.3	1.255	64.3	60.2	90	4		656	615	101.4	1.721	64.3	60.2	93
5		624	601	75.5	1.178	66.5	64.0	89	5		771	743	83.8	1.615	66.5	64.0	92
6		702	688	58.7	1.071	63.9	62.7	88	6		867	850	65.2	1.469	63.9	62.7	91
7		705	697	45.2	0.924	57.4	56.7	88	7		870	860	50.2	1.267	57.4	56.7	91
1	2200	296	186	164.9	2.396	33.9	21.3	100	1	2400	352	221	179.9	3.111	33.9	21.3	102
2		491	406	144.6	2.398	49.3	40.8	98	2		584	484	157.7	3.113	49.3	40.8	100
3		652	586	128.1	2.364	58.8	52.8	96	3		776	697	139.8	3.069	58.8	52.8	99
4		794	744	111.6	2.291	64.3	60.2	95	4		945	885	121.7	2.974	64.3	60.2	98
5		933	898	92.2	2.150	66.5	64.0	94	5		1110	1069	100.6	2.791	66.5	64.0	96
6		1049	1028	71.7	1.956	63.9	62.7	93	6		1248	1224	78.2	2.539	63.9	62.7	95
7		1053	1041	55.3	1.687	57.4	56.7	93	7		1253	1239	60.3	2.190	57.4	56.7	95
1	2600	413	259	194.9	3.955	33.9	21.3	104	1	2800	479	301	209.9	4.940	33.9	21.3	106
2		686	568	170.9	3.958	49.3	40.8	102	2		795	658	184.0	4.944	49.3	40.8	104
3		911	818	151.4	3.902	58.8	52.8	100	3		1056	949	163.1	4.874	58.8	52.8	102
4		1109	1039	131.9	3.782	64.3	60.2	99	4		1286	1205	142.0	4.723	64.3	60.2	101
5		1303	1255	108.0	3.549	66.5	64.0	98	5		1511	1455	117.4	4.433	66.5	64.0	100
6		1465	1436	84.8	3.228	63.9	62.7	97	6		1699	1665	91.3	4.032	63.9	62.7	99
7		1471	1454	65.3	2.784	57.4	56.7	97	7		1706	1686	70.3	3.477	57.4	56.7	99
1	3000	550	345	224.9	6.076	33.9	21.3	107	1	3200	626	393	239.9	7.374	33.9	21.3	109
2		913	756	197.2	6.081	49.3	40.8	105	2		1039	860	210.3	7.380	49.3	40.8	107
3		1213	1089	174.7	5.994	58.8	52.8	103	3		1380	1240	186.4	7.275	58.8	52.8	105
4		1476	1383	152.2	5.810	64.3	60.2	103	4		1680	1573	162.3	7.051	64.3	60.2	104
5		1735	1671	125.8	5.452	66.5	64.0	101	5		1974	1901	134.1	6.617	66.5	64.0	103
6		1950	1912	97.8	4.959	63.9	62.7	100	6		2219	2175	104.3	6.019	63.9	62.7	102
7		1958	1935	75.4	4.277	57.4	56.7	100	7		2228	2202	80.4	5.190	57.4	56.7	102
1	3400	706	443	254.9	8.844	33.9	21.3	110	1	3600	792	497	269.9	10.499	33.9	21.3	112
2		1173	971	223.4	8.852	49.3	40.8	108	2		1315	1088	236.6	10.508	49.3	40.8	109
3		1558	1399	198.0	8.726	58.8	52.8	106	3		1746	1569	209.7	10.358	58.8	52.8	108
4		1896	1776	172.4	8.457	64.3	60.2	106	4		2126	1991	182.6	10.039	64.3	60.2	107
5		2228	2146	142.5	7.936	66.5	64.0	104	5		2498	2406	150.9	9.421	66.5	64.0	106
6		2505	2456	110.8	7.219	63.9	62.7	103	6		2808	2753	117.4	8.570	63.9	62.7	105
7		2515	2486	85.4	6.226	57.4	56.7	103	7		2820	2787	90.4	7.390	57.4	56.7	105
1	3750	859	539	281.1	11.867	33.9	21.3	113									
2		1426	1181	246.5	11.877	49.3	40.8	110									
3		1895	1702	218.4	11.708	58.8	52.8	109									
4		2307	2161	190.2	11.347	64.3	60.2	108									
5		2710	2611	157.2	10.648	66.5	64.0	107									
6		3047	2987	122.3	9.686	63.9	62.7	106									
7		3060	3024	94.2	8.353	57.4	56.7	106									

- The A-weighted sound ratings shown have been calculated per AMCA International Standard 301.
- Values shown are for inlet LwA sound power levels for installation type B - free inlet, ducted outlet.
- Performance certified is for installation type B - free inlet, ducted outlet.
- Performance ratings do not include the effects of appurtenances(accessories).
- Power rating (kW) does not include transmission losses.



Wheel dia. 355 mm	Tip Speed 0.0186 × rpm	Outlet Dim. 453 × 453	Outlet Area 0.2052 m <sup>2</sup>	Class 1 3228 rpm	Class 2 4304 rpm	Not Applicable
-------------------	------------------------	-----------------------	-----------------------------------	------------------	------------------	----------------

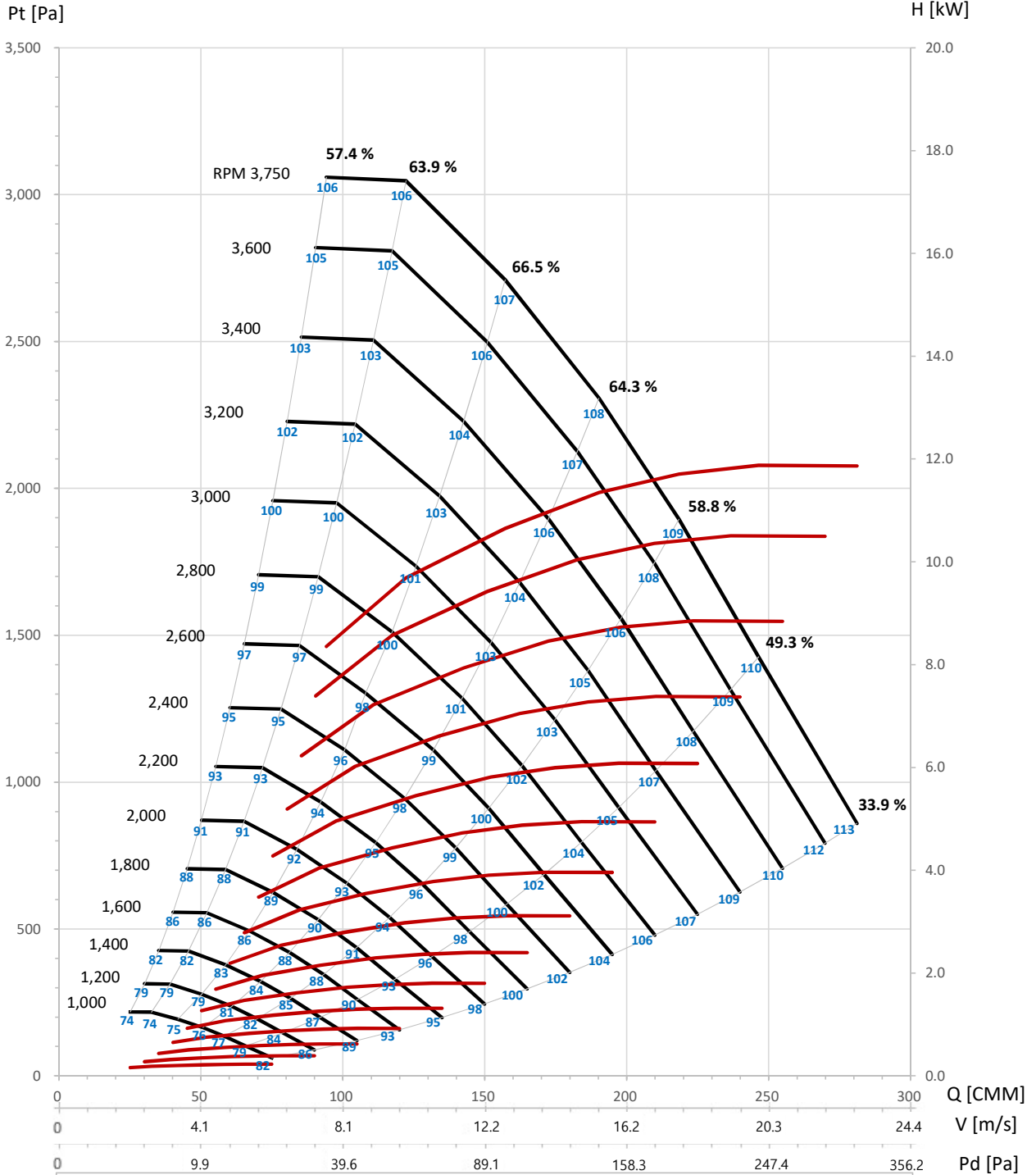

- The A-weighted sound ratings shown have been calculated per AMCA International Standard 301.
- Values shown are for inlet LwIA sound power levels for installation type B - free inlet, ducted outlet.
- Performance certified is for installation type B - free inlet, ducted outlet.
- Performance ratings do not include the effects of appurtenances(accessories).
- Power rating (kW) does not include transmission losses.



Wheel dia. 400 mm	Tip Speed 0.0209 × rpm	Outlet Dim. 507 × 507	Outlet Area 0.2570 m <sup>2</sup>	Class 1 2865 rpm	Class 2 3820 rpm	Not Applicable
-------------------	------------------------	-----------------------	-----------------------------------	------------------	------------------	----------------

Det.	N	Pt	Ps	Q	H	EtaT	EtaS	Lwi	Det.	N	Pt	Ps	Q	H	EtaT	EtaS	Lwi
	[r/min]	[Pa]	[Pa]	[m <sup>3</sup> /min]	[kW]	[%]	[%]	[dB(A)]		[r/min]	[Pa]	[Pa]	[m <sup>3</sup> /min]	[kW]	[%]	[%]	[dB(A)]
1	1400	152	95	150.4	1.125	33.9	21.3	93	1	1600	199	125	171.9	1.679	33.9	21.3	96
2		253	209	131.9	1.126	49.3	40.8	91	2		330	273	150.7	1.680	49.3	40.8	94
3		336	302	116.8	1.110	58.8	52.8	89	3		438	394	133.5	1.656	58.8	52.8	92
4		409	383	101.8	1.075	64.3	60.2	88	4		534	500	116.3	1.605	64.3	60.2	91
5		480	462	84.1	1.009	66.5	64.0	87	5		627	604	96.1	1.507	66.5	64.0	90
6		540	529	65.4	0.918	63.9	62.7	86	6		705	691	74.7	1.370	63.9	62.7	89
7		542	536	50.4	0.792	57.4	56.7	86	7		708	700	57.6	1.182	57.4	56.7	89
1	1800	252	158	193.4	2.390	33.9	21.3	99	1	2000	311	195	214.8	3.279	33.9	21.3	101
2		418	346	169.5	2.393	49.3	40.8	97	2		516	427	188.4	3.282	49.3	40.8	99
3		555	499	150.2	2.359	58.8	52.8	95	3		685	615	166.9	3.235	58.8	52.8	98
4		676	633	130.8	2.286	64.3	60.2	94	4		834	781	145.4	3.135	64.3	60.2	97
5		794	765	108.1	2.145	66.5	64.0	93	5		980	944	120.1	2.942	66.5	64.0	95
6		892	875	84.1	1.951	63.9	62.7	92	6		1102	1080	93.4	2.677	63.9	62.7	94
7		896	886	64.8	1.683	57.4	56.7	92	7		1106	1093	72.0	2.308	57.4	56.7	94
1	2200	376	236	236.3	4.364	33.9	21.3	104	1	2400	447	281	257.8	5.666	33.9	21.3	106
2		624	517	207.2	4.368	49.3	40.8	102	2		743	615	226.0	5.671	49.3	40.8	104
3		829	745	183.6	4.306	58.8	52.8	100	3		987	886	200.3	5.591	58.8	52.8	102
4		1009	945	159.9	4.173	64.3	60.2	99	4		1201	1125	174.4	5.418	64.3	60.2	101
5		1186	1142	132.2	3.916	66.5	64.0	98	5		1411	1359	144.2	5.085	66.5	64.0	100
6		1333	1307	102.8	3.563	63.9	62.7	97	6		1587	1555	112.1	4.625	63.9	62.7	99
7		1338	1323	79.2	3.072	57.4	56.7	97	7		1593	1574	86.4	3.989	57.4	56.7	99
1	2600	525	329	279.3	7.204	33.9	21.3	108	1	2800	609	382	300.8	8.998	33.9	21.3	109
2		872	721	244.9	7.210	49.3	40.8	106	2		1011	837	263.7	9.006	49.3	40.8	107
3		1158	1040	217.0	7.108	58.8	52.8	104	3		1343	1206	233.7	8.878	58.8	52.8	106
4		1409	1320	189.0	6.889	64.3	60.2	103	4		1635	1531	203.5	8.604	64.3	60.2	105
5		1656	1595	156.2	6.465	66.5	64.0	102	5		1921	1850	168.2	8.074	66.5	64.0	103
6		1862	1825	121.5	5.881	63.9	62.7	101	6		2160	2117	130.8	7.345	63.9	62.7	102
7		1869	1848	93.6	5.071	57.4	56.7	101	7		2168	2143	100.8	6.334	57.4	56.7	102
1	3000	699	439	322.3	11.067	33.9	21.3	111	1	3200	795	499	343.7	13.431	33.9	21.3	112
2		1160	960	282.5	11.076	49.3	40.8	109	2		1320	1093	301.4	13.443	49.3	40.8	110
3		1542	1385	250.4	10.919	58.8	52.8	107	3		1754	1576	267.1	13.252	58.8	52.8	109
4		1876	1758	218.1	10.582	64.3	60.2	106	4		2135	2000	232.6	12.843	64.3	60.2	108
5		2205	2124	180.2	9.931	66.5	64.0	105	5		2509	2416	192.2	12.052	66.5	64.0	106
6		2479	2430	140.2	9.034	63.9	62.7	104	6		2821	2765	149.5	10.963	63.9	62.7	106
7		2489	2460	108.0	7.790	57.4	56.7	104	7		2832	2799	115.2	9.455	57.4	56.7	105
1	3400	898	563	365.2	16.110	33.9	21.3	114									
2		1491	1234	320.2	16.124	49.3	40.8	112									
3		1980	1779	283.8	15.895	58.8	52.8	110									
4		2410	2258	247.1	15.405	64.3	60.2	109									
5		2832	2728	204.2	14.456	66.5	64.0	108									
6		3184	3121	158.8	13.150	63.9	62.7	107									
7		3197	3160	122.4	11.340	57.4	56.7	107									

- The A-weighted sound ratings shown have been calculated per AMCA International Standard 301.
- Values shown are for inlet LwiA sound power levels for installation type B - free inlet, ducted outlet.
- Performance certified is for installation type B - free inlet, ducted outlet.
- Performance ratings do not include the effects of appurtenances(accessories).
- Power rating (kW) does not include transmission losses.



Wheel dia. 400 mm	Tip Speed 0.0209 × rpm	Outlet Dim. 507 × 507	Outlet Area 0.2570 m <sup>2</sup>	Class 1 2865 rpm	Class 2 3820 rpm	Not Applicable
-------------------	------------------------	-----------------------	-----------------------------------	------------------	------------------	----------------

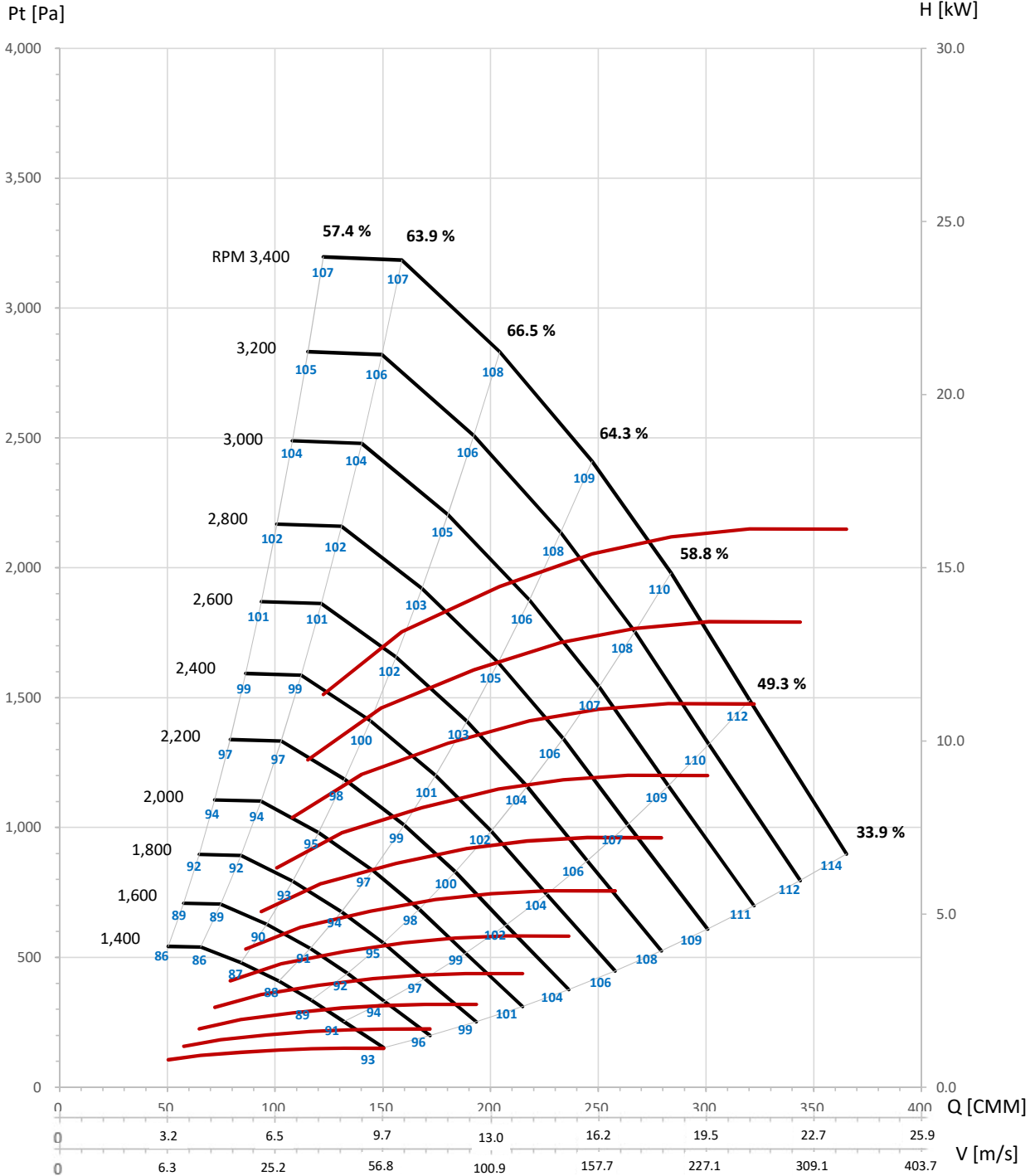

- The A-weighted sound ratings shown have been calculated per AMCA International Standard 301.
- Values shown are for inlet LwA sound power levels for installation type B - free inlet, ducted outlet.
- Performance certified is for installation type B - free inlet, ducted outlet.
- Performance ratings do not include the effects of appurtenances(accessories).
- Power rating (kW) does not include transmission losses.

Pd [Pa]





Wheel dia. 450 mm	Tip Speed 0.0236 × rpm	Outlet Dim. 569 × 569	Outlet Area 0.3238 m <sup>2</sup>	Class 1 2546 rpm	Class 2 3395 rpm	Not Applicable
-------------------	------------------------	-----------------------	-----------------------------------	------------------	------------------	----------------

Det.									Det.								
	N [r/min]	Pt [Pa]	Ps [Pa]	Q [m <sup>3</sup> /min]	H [kW]	EtaT [%]	EtaS [%]	Lwi [dB(A)]		N [r/min]	Pt [Pa]	Ps [Pa]	Q [m <sup>3</sup> /min]	H [kW]	EtaT [%]	EtaS [%]	Lwi [dB(A)]
1	1000	98	62	153.1	0.740	33.9	21.3	89	1	1200	142	89	183.7	1.278	33.9	21.3	93
2		163	135	134.2	0.740	49.3	40.8	87	2		235	195	161.0	1.279	49.3	40.8	91
3		217	195	118.9	0.730	58.8	52.8	85	3		312	281	142.7	1.261	58.8	52.8	89
4		264	247	103.6	0.707	64.3	60.2	84	4		380	356	124.3	1.222	64.3	60.2	88
5		310	299	85.6	0.664	66.5	64.0	82	5		447	430	102.7	1.147	66.5	64.0	87
6		349	342	66.6	0.604	63.9	62.7	82	6		502	492	79.9	1.043	63.9	62.7	86
7		350	346	51.3	0.521	57.4	56.7	82	7		504	498	61.6	0.900	57.4	56.7	86
1	1400	193	121	214.3	2.030	33.9	21.3	97	1	1600	252	158	244.9	3.030	33.9	21.3	100
2		320	265	187.9	2.031	49.3	40.8	94	2		418	346	214.7	3.032	49.3	40.8	97
3		425	382	166.5	2.002	58.8	52.8	93	3		555	499	190.3	2.989	58.8	52.8	96
4		517	485	145.0	1.941	64.3	60.2	92	4		676	633	165.7	2.897	64.3	60.2	95
5		608	586	119.8	1.821	66.5	64.0	90	5		794	765	137.0	2.719	66.5	64.0	93
6		684	670	93.2	1.657	63.9	62.7	90	6		893	875	106.5	2.473	63.9	62.7	93
7		686	678	71.8	1.429	57.4	56.7	90	7		896	886	82.1	2.133	57.4	56.7	93
1	1800	319	200	275.5	4.314	33.9	21.3	103	1	2000	393	247	306.2	5.917	33.9	21.3	105
2		529	438	241.6	4.317	49.3	40.8	100	2		653	541	268.4	5.922	49.3	40.8	103
3		703	631	214.1	4.256	58.8	52.8	99	3		868	779	237.9	5.838	58.8	52.8	101
4		855	801	186.4	4.125	64.3	60.2	98	4		1056	989	207.1	5.658	64.3	60.2	100
5		1005	968	154.1	3.871	66.5	64.0	96	5		1241	1195	171.2	5.310	66.5	64.0	99
6		1130	1108	119.8	3.521	63.9	62.7	96	6		1395	1368	133.1	4.830	63.9	62.7	98
7		1135	1121	92.3	3.036	57.4	56.7	96	7		1401	1384	102.6	4.165	57.4	56.7	98
1	2200	476	299	336.8	7.876	33.9	21.3	107	1	2400	567	355	367.4	10.225	33.9	21.3	109
2		790	654	295.3	7.882	49.3	40.8	105	2		940	778	322.1	10.234	49.3	40.8	107
3		1050	943	261.6	7.770	58.8	52.8	104	3		1249	1122	285.4	10.088	58.8	52.8	106
4		1278	1197	227.9	7.531	64.3	60.2	103	4		1521	1424	248.6	9.777	64.3	60.2	105
5		1501	1446	188.3	7.067	66.5	64.0	101	5		1787	1721	205.5	9.175	66.5	64.0	104
6		1688	1655	146.5	6.429	63.9	62.7	100	6		2009	1969	159.8	8.346	63.9	62.7	102
7		1695	1675	112.9	5.544	57.4	56.7	100	7		2017	1994	123.1	7.197	57.4	56.7	102
1	2600	665	417	398.0	13.000	33.9	21.3	111	1	2800	771	484	428.6	16.237	33.9	21.3	113
2		1104	914	348.9	13.011	49.3	40.8	109	2		1280	1060	375.8	16.250	49.3	40.8	111
3		1466	1317	309.2	12.826	58.8	52.8	108	3		1700	1528	333.0	16.020	58.8	52.8	109
4		1785	1672	269.3	12.431	64.3	60.2	107	4		2070	1939	290.0	15.525	64.3	60.2	108
5		2097	2020	222.6	11.665	66.5	64.0	105	5		2432	2343	239.7	14.570	66.5	64.0	107
6		2358	2311	173.1	10.611	63.9	62.7	104	6		2735	2681	186.4	13.253	63.9	62.7	106
7		2367	2340	133.4	9.151	57.4	56.7	104	7		2746	2713	143.6	11.429	57.4	56.7	106
1	3000	885	555	459.2	19.970	33.9	21.3	115	1	3200	1007	632	489.8	24.237	33.9	21.3	116
2		1469	1216	402.6	19.987	49.3	40.8	112	2		1672	1384	429.5	24.257	49.3	40.8	114
3		1952	1754	356.8	19.703	58.8	52.8	111	3		2221	1995	380.6	23.913	58.8	52.8	112
4		2376	2226	310.7	19.096	64.3	60.2	110	4		2704	2532	331.4	23.175	64.3	60.2	111
5		2792	2689	256.8	17.920	66.5	64.0	109	5		3177	3060	273.9	21.748	66.5	64.0	110
6		3139	3077	199.7	16.301	63.9	62.7	108	6		3572	3501	213.0	19.784	63.9	62.7	109
7		3152	3115	153.9	14.058	57.4	56.7	108	7		3586	3544	164.2	17.061	57.4	56.7	109

- The A-weighted sound ratings shown have been calculated per AMCA International Standard 301.
- Values shown are for inlet LwA sound power levels for installation type B - free inlet, ducted outlet.
- Performance certified is for installation type B - free inlet, ducted outlet.
- Performance ratings do not include the effects of appurtenances(accessories).
- Power rating (kW) does not include transmission losses.



Wheel dia. 450 mm	Tip Speed 0.0236 × rpm	Outlet Dim. 569 × 569	Outlet Area 0.3238 m <sup>2</sup>	Class 1 2546 rpm	Class 2 3395 rpm	Not Applicable
-------------------	------------------------	-----------------------	-----------------------------------	------------------	------------------	----------------

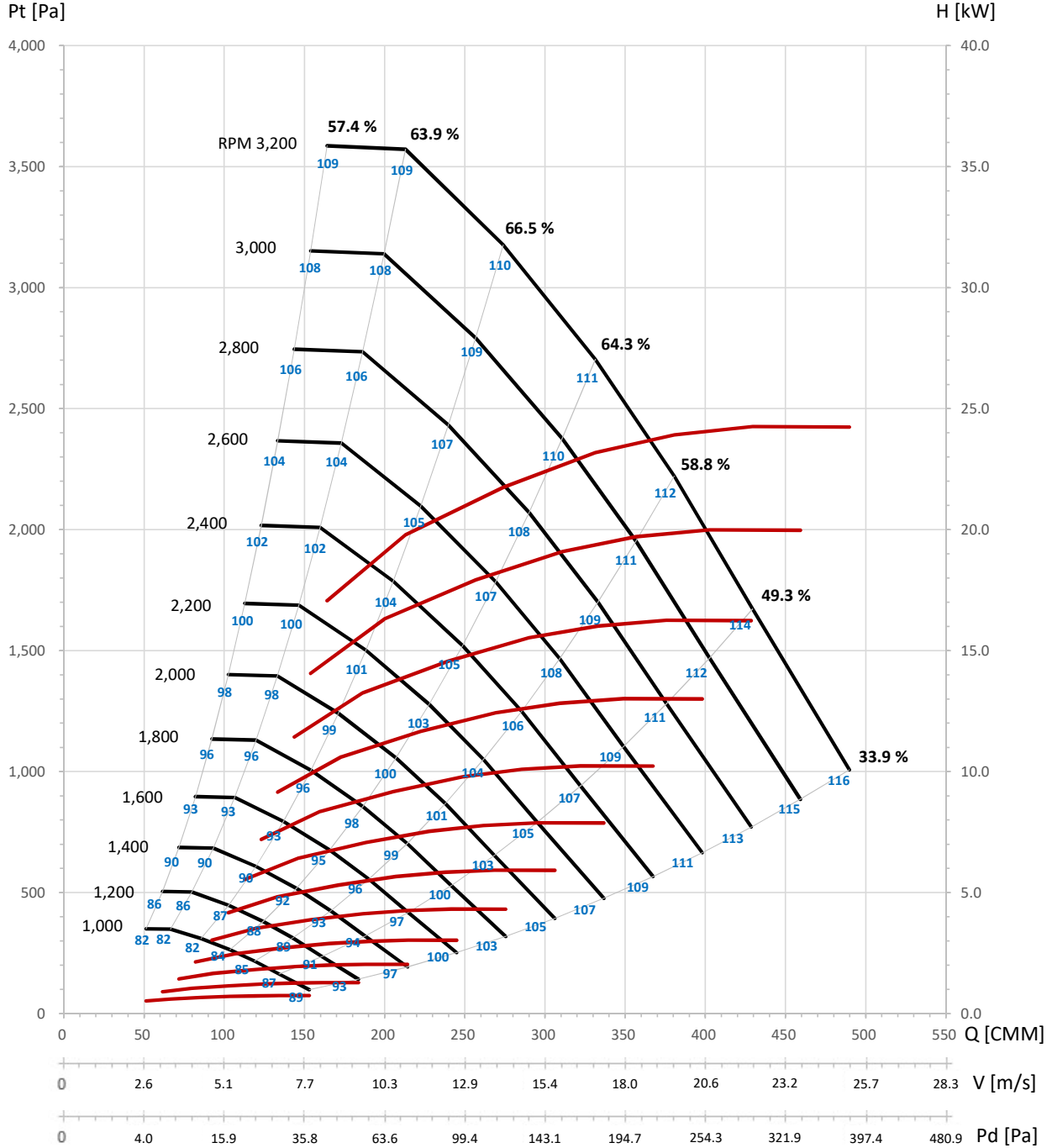

- The A-weighted sound ratings shown have been calculated per AMCA International Standard 301.  
 - Values shown are for inlet LwA sound power levels for installation type B - free inlet, ducted outlet.  
 - Performance certified is for installation type B - free inlet, ducted outlet.  
 - Performance ratings do not include the effects of appurtenances(accessories).  
 - Power rating (kW) does not include transmission losses.



Wheel dia. 500 mm	Tip Speed 0.0262 × rpm	Outlet Dim. 638 × 638	Outlet Area 0.4070 m <sup>2</sup>	Class 1 2292 rpm	Class 2 3056 rpm	Not Applicable
-------------------	------------------------	-----------------------	-----------------------------------	------------------	------------------	----------------

Det.									Det.								
	N [r/min]	Pt [Pa]	Ps [Pa]	Q [m <sup>3</sup> /min]	H [kW]	EtaT [%]	EtaS [%]	Lwi [dB(A)]		N [r/min]	Pt [Pa]	Ps [Pa]	Q [m <sup>3</sup> /min]	H [kW]	EtaT [%]	EtaS [%]	Lwi [dB(A)]
1	1000	154	113	203.9	1.256	41.6	30.5	90	1	1200	222	162	244.7	2.171	41.6	30.5	94
2	1000	219	186	183.4	1.233	54.3	46.1	89	2	1200	316	268	220.1	2.131	54.3	46.1	93
3	1000	288	262	160.1	1.198	63.9	58.3	87	3	1200	414	378	192.1	2.069	63.9	58.3	92
4	1000	352	334	135.1	1.144	69.1	65.5	87	4	1200	506	480	162.2	1.976	69.1	65.5	91
5	1000	391	377	117.0	1.082	70.2	67.7	86	5	1200	562	543	140.4	1.869	70.2	67.7	90
6	1000	435	427	93.4	0.998	67.7	66.4	86	6	1200	627	614	112.1	1.724	67.7	66.4	90
1	1400	302	221	285.4	3.447	41.6	30.5	98	1	1600	394	289	326.2	5.145	41.6	30.5	101
2	1400	430	365	256.8	3.384	54.3	46.1	97	2	1600	562	476	293.5	5.051	54.3	46.1	100
3	1400	564	514	224.1	3.286	63.9	58.3	95	3	1600	736	672	256.1	4.905	63.9	58.3	99
4	1400	689	654	189.2	3.138	69.1	65.5	95	4	1600	900	854	216.2	4.684	69.1	65.5	98
5	1400	766	739	163.8	2.968	70.2	67.7	94	5	1600	1000	965	187.2	4.430	70.2	67.7	97
6	1400	853	836	130.8	2.737	67.7	66.4	94	6	1600	1114	1092	149.5	4.086	67.7	66.4	97
1	1800	499	365	367.0	7.326	41.6	30.5	104	1	2000	616	451	407.8	10.049	41.6	30.5	107
2	1800	711	603	330.2	7.192	54.3	46.1	103	2	2000	877	744	366.9	9.865	54.3	46.1	105
3	1800	932	850	288.1	6.984	63.9	58.3	102	3	2000	1151	1049	320.1	9.580	63.9	58.3	104
4	1800	1139	1081	243.3	6.669	69.1	65.5	101	4	2000	1407	1335	270.3	9.149	69.1	65.5	103
5	1800	1265	1222	210.5	6.308	70.2	67.7	100	5	2000	1562	1508	233.9	8.653	70.2	67.7	102
6	1800	1410	1382	168.2	5.817	67.7	66.4	100	6	2000	1741	1707	186.9	7.980	67.7	66.4	102
1	2200	745	546	448.5	13.375	41.6	30.5	109	1	2400	887	649	489.3	17.365	41.6	30.5	111
2	2200	1062	900	403.5	13.131	54.3	46.1	108	2	2400	1263	1071	440.2	17.047	54.3	46.1	110
3	2200	1392	1270	352.1	12.751	63.9	58.3	106	3	2400	1657	1511	384.1	16.555	63.9	58.3	108
4	2200	1702	1615	297.3	12.177	69.1	65.5	105	4	2400	2026	1922	324.3	15.809	69.1	65.5	107
5	2200	1890	1825	257.3	11.517	70.2	67.7	104	5	2400	2250	2172	280.7	14.953	70.2	67.7	106
6	2200	2107	2065	205.5	10.621	67.7	66.4	104	6	2400	2507	2458	224.2	13.790	67.7	66.4	106
1	2600	1041	762	530.1	22.078	41.6	30.5	113	1	2800	1207	884	570.9	27.574	41.6	30.5	115
2	2600	1483	1257	476.9	21.674	54.3	46.1	111	2	2800	1720	1458	513.6	27.070	54.3	46.1	113
3	2600	1945	1774	416.1	21.048	63.9	58.3	110	3	2800	2255	2057	448.2	26.288	63.9	58.3	112
4	2600	2377	2255	351.4	20.100	69.1	65.5	109	4	2800	2757	2616	378.4	25.104	69.1	65.5	111
5	2600	2640	2549	304.1	19.011	70.2	67.7	108	5	2800	3062	2956	327.5	23.745	70.2	67.7	110
6	2600	2943	2884	242.9	17.532	67.7	66.4	108	6	2800	3413	3345	261.6	21.897	67.7	66.4	110
1	3000	1385	1014	611.7	33.915	41.6	30.5	116									
2	3000	1974	1674	550.3	33.295	54.3	46.1	115									
3	3000	2589	2361	480.2	32.333	63.9	58.3	113									
4	3000	3165	3003	405.4	30.877	69.1	65.5	112									
5	3000	3515	3394	350.9	29.205	70.2	67.7	111									
6	3000	3918	3840	280.3	26.933	67.7	66.4	112									

- The A-weighted sound ratings shown have been calculated per AMCA International Standard 301.
- Values shown are for inlet LwiA sound power levels for installation type B - free inlet, ducted outlet.
- Performance certified is for installation type B - free inlet, ducted outlet.
- Performance ratings do not include the effects of appurtenances(accessories).
- Power rating (kW) does not include transmission losses.



Wheel dia. 500 mm	Tip Speed 0.0262 × rpm	Outlet Dim. 638 × 638	Outlet Area 0.4070 m <sup>2</sup>	Class 1 2292 rpm	Class 2 3056 rpm	Not Applicable
-------------------	------------------------	-----------------------	-----------------------------------	------------------	------------------	----------------

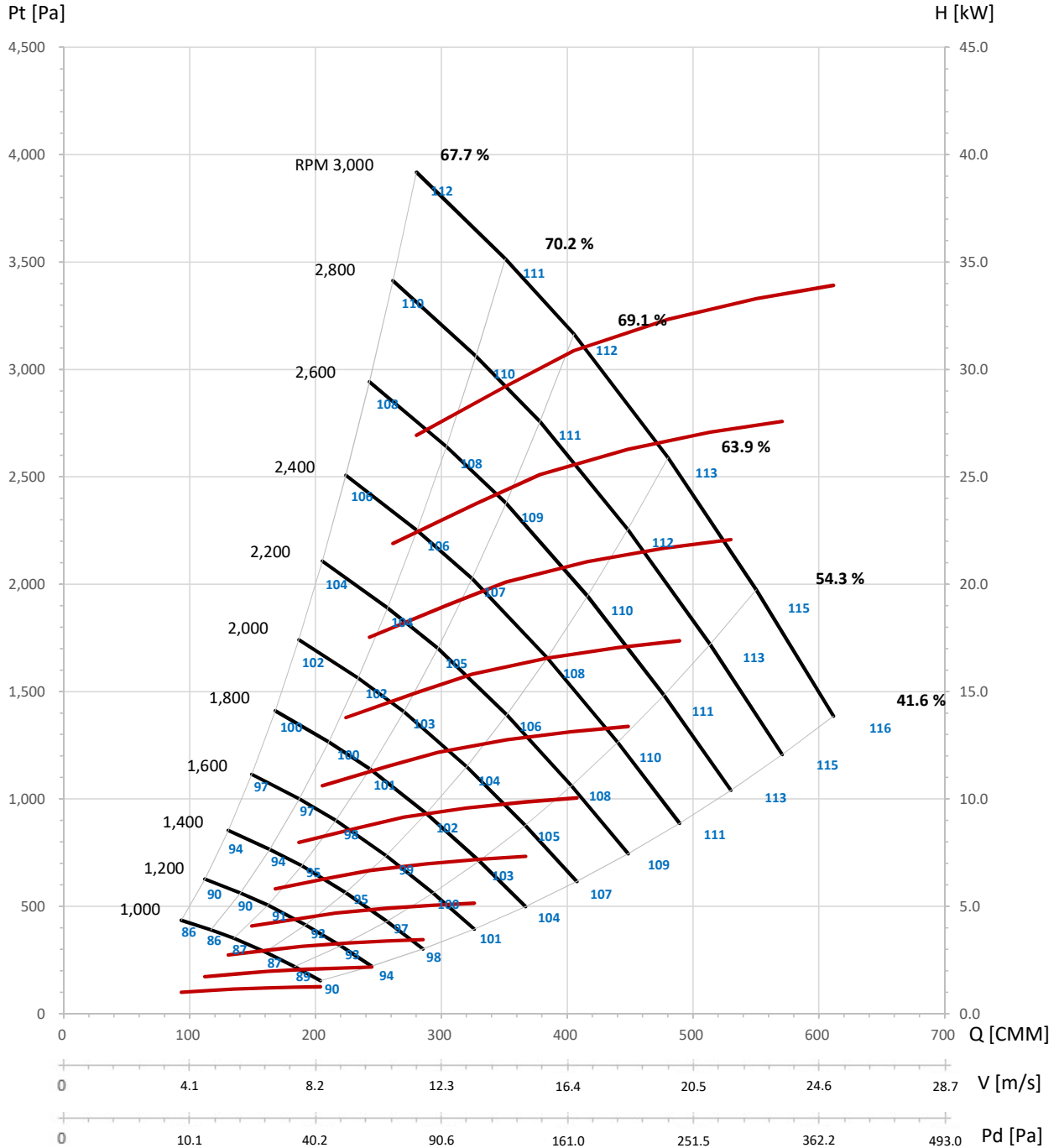

- The A-weighted sound ratings shown have been calculated per AMCA International Standard 301.  
 - Values shown are for inlet LwA sound power levels for installation type B - free inlet, ducted outlet.  
 - Performance certified is for installation type B - free inlet, ducted outlet.  
 - Performance ratings do not include the effects of appurtenances(accessories).  
 - Power rating (kW) does not include transmission losses.



Wheel dia. 560 mm | Tip Speed 0.0293 × rpm | Outlet Dim. 715 × 715 | Outlet Area 0.5112 m<sup>2</sup> | Class 1 2046 rpm | Class 2 2728 rpm | Not Applicable

Det.									Det.								
	N	Pt	Ps	Q	H	EtaT	EtaS	Lwi		N	Pt	Ps	Q	H	EtaT	EtaS	Lwi
	[r/min]	[Pa]	[Pa]	[m <sup>3</sup> /min]	[kW]	[%]	[%]	[dB(A)]		[r/min]	[Pa]	[Pa]	[m <sup>3</sup> /min]	[kW]	[%]	[%]	[dB(A)]
1	155	114	254.7	1.582	41.6	30.5	91	1	192	140	283.0	2.170	41.6	30.5	94		
2	221	187	229.2	1.553	54.3	46.1	90	2	273	231	254.6	2.130	54.3	46.1	92		
3	290	264	200.0	1.508	63.9	58.3	88	3	358	326	222.2	2.069	63.9	58.3	91		
4	354	336	168.8	1.440	69.1	65.5	88	4	438	415	187.6	1.976	69.1	65.5	90		
5	394	380	146.1	1.362	70.2	67.7	87	5	486	469	162.4	1.869	70.2	67.7	89		
6	439	430	116.7	1.256	67.7	66.4	87	6	542	531	129.7	1.723	67.7	66.4	89		
1	276	202	339.6	3.750	41.6	30.5	98	1	375	275	396.2	5.954	41.6	30.5	102		
2	393	333	305.6	3.681	54.3	46.1	96	2	535	454	356.5	5.846	54.3	46.1	100		
3	515	470	266.6	3.575	63.9	58.3	95	3	702	640	311.1	5.677	63.9	58.3	99		
4	630	598	225.1	3.414	69.1	65.5	94	4	858	814	262.6	5.421	69.1	65.5	98		
5	700	676	194.9	3.229	70.2	67.7	93	5	953	920	227.3	5.127	70.2	67.7	97		
6	780	765	155.6	2.978	67.7	66.4	94	6	1062	1041	181.6	4.728	67.7	66.4	97		
1	490	359	452.9	8.888	41.6	30.5	105	1	621	454	509.5	12.655	41.6	30.5	108		
2	699	593	407.4	8.726	54.3	46.1	103	2	884	750	458.3	12.424	54.3	46.1	106		
3	916	836	355.5	8.474	63.9	58.3	102	3	1160	1058	399.9	12.065	63.9	58.3	105		
4	1120	1063	300.2	8.092	69.1	65.5	101	4	1418	1345	337.7	11.522	69.1	65.5	104		
5	1244	1201	259.8	7.654	70.2	67.7	100	5	1575	1520	292.3	10.898	70.2	67.7	103		
6	1387	1359	207.5	7.058	67.7	66.4	101	6	1755	1720	233.5	10.050	67.7	66.4	103		
1	766	561	566.1	17.360	41.6	30.5	110	1	927	679	622.7	23.106	41.6	30.5	112		
2	1092	926	509.3	17.042	54.3	46.1	109	2	1321	1120	560.2	22.684	54.3	46.1	111		
3	1432	1306	444.4	16.550	63.9	58.3	107	3	1733	1580	488.8	22.028	63.9	58.3	109		
4	1750	1661	375.2	15.805	69.1	65.5	106	4	2118	2009	412.7	21.036	69.1	65.5	108		
5	1944	1877	324.8	14.949	70.2	67.7	106	5	2352	2271	357.2	19.897	70.2	67.7	108		
6	2167	2124	259.4	13.786	67.7	66.4	106	6	2622	2570	285.3	18.349	67.7	66.4	108		
1	1103	808	679.3	29.998	41.6	30.5	114	1	1295	948	735.9	38.139	41.6	30.5	116		
2	1572	1333	611.1	29.449	54.3	46.1	113	2	1845	1565	662.1	37.442	54.3	46.1	115		
3	2062	1881	533.3	28.598	63.9	58.3	111	3	2420	2207	577.7	36.360	63.9	58.3	113		
4	2521	2391	450.3	27.311	69.1	65.5	110	4	2958	2807	487.8	34.723	69.1	65.5	112		
5	2800	2703	389.7	25.831	70.2	67.7	110	5	3286	3172	422.2	32.842	70.2	67.7	111		
6	3120	3058	311.3	23.822	67.7	66.4	110	6	3662	3589	337.2	30.287	67.7	66.4	112		
1	1396	1023	764.2	42.711	41.6	30.5	117										
2	1990	1687	687.5	41.931	54.3	46.1	116										
3	2610	2380	599.9	40.719	63.9	58.3	114										
4	3190	3027	506.5	38.886	69.1	65.5	113										
5	3543	3421	438.4	36.779	70.2	67.7	112										
6	3949	3871	350.2	33.918	67.7	66.4	112										

- The A-weighted sound ratings shown have been calculated per AMCA International Standard 301.
- Values shown are for inlet LwiA sound power levels for installation type B - free inlet, ducted outlet.
- Performance certified is for installation type B - free inlet, ducted outlet.
- Performance ratings do not include the effects of appurtenances(accessories).
- Power rating (kW) does not include transmission losses.



Wheel dia. 560 mm	Tip Speed 0.0293 × rpm	Outlet Dim. 715 × 715	Outlet Area 0.5112 m <sup>2</sup>	Class 1 2046 rpm	Class 2 2728 rpm	Not Applicable
-------------------	------------------------	-----------------------	-----------------------------------	------------------	------------------	----------------

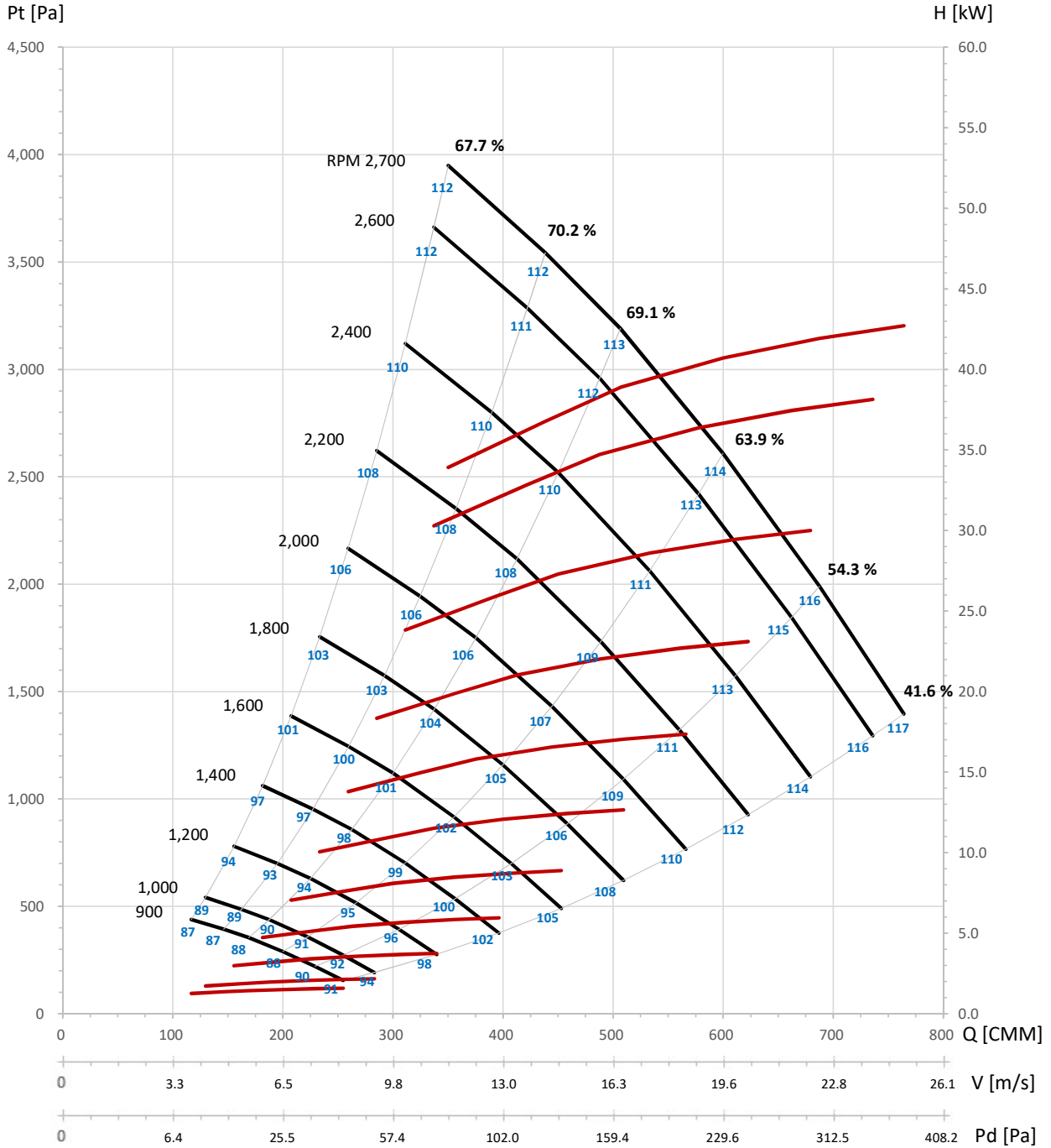

- The A-weighted sound ratings shown have been calculated per AMCA International Standard 301.
- Values shown are for inlet LwA sound power levels for installation type B - free inlet, ducted outlet.
- Performance certified is for installation type B - free inlet, ducted outlet.
- Performance ratings do not include the effects of appurtenances(accessories).
- Power rating (kW) does not include transmission losses.



Wheel dia. 630 mm | Tip Speed 0.033 × rpm | Outlet Dim. 801 × 801 | Outlet Area 0.6416 m<sup>2</sup> | Class 1 1819 rpm | Class 2 2425 rpm | Not Applicable

Det.									Det.								
	N	Pt	Ps	Q	H	EtaT	EtaS	Lwi		N	Pt	Ps	Q	H	EtaT	EtaS	Lwi
	[r/min]	[Pa]	[Pa]	[m <sup>3</sup> /min]	[kW]	[%]	[%]	[dB(A)]		[r/min]	[Pa]	[Pa]	[m <sup>3</sup> /min]	[kW]	[%]	[%]	[dB(A)]
1	155	114	322.4	2.002	41.6	30.5	92	1	242	178	403.0	3.910	41.6	30.5	97		
2	221	187	290.0	1.966	54.3	46.1	90	2	345	293	362.6	3.839	54.3	46.1	96		
3	290	264	253.1	1.909	63.9	58.3	89	3	453	413	316.4	3.728	63.9	58.3	94		
4	354	336	213.7	1.823	69.1	65.5	88	4	554	525	267.1	3.560	69.1	65.5	94		
5	394	380	185.0	1.724	70.2	67.7	88	5	615	594	231.2	3.367	70.2	67.7	93		
6	439	430	147.7	1.590	67.7	66.4	88	6	686	672	184.7	3.105	67.7	66.4	93		
1	349	256	483.6	6.757	41.6	30.5	101	1	475	348	564.2	10.730	41.6	30.5	105		
2	497	422	435.1	6.634	54.3	46.1	100	2	677	574	507.6	10.534	54.3	46.1	104		
3	652	595	379.6	6.442	63.9	58.3	99	3	888	810	442.9	10.229	63.9	58.3	102		
4	798	757	320.5	6.152	69.1	65.5	98	4	1086	1030	374.0	9.769	69.1	65.5	101		
5	886	855	277.4	5.819	70.2	67.7	97	5	1206	1164	323.7	9.240	70.2	67.7	101		
6	987	968	221.6	5.366	67.7	66.4	97	6	1344	1317	258.5	8.521	67.7	66.4	101		
1	621	454	644.8	16.017	41.6	30.5	108	1	785	575	725.4	22.805	41.6	30.5	111		
2	884	750	580.1	15.724	54.3	46.1	107	2	1119	949	652.6	22.388	54.3	46.1	110		
3	1160	1058	506.2	15.270	63.9	58.3	106	3	1468	1339	569.5	21.741	63.9	58.3	108		
4	1418	1345	427.4	14.582	69.1	65.5	105	4	1795	1703	480.8	20.762	69.1	65.5	108		
5	1575	1520	369.9	13.792	70.2	67.7	104	5	1993	1924	416.2	19.638	70.2	67.7	107		
6	1755	1720	295.5	12.719	67.7	66.4	104	6	2221	2177	332.4	18.110	67.7	66.4	107		
1	970	710	806.0	31.283	41.6	30.5	114	1	1069	783	846.3	36.214	41.6	30.5	115		
2	1382	1172	725.1	30.711	54.3	46.1	112	2	1524	1292	761.4	35.552	54.3	46.1	113		
3	1812	1653	632.7	29.824	63.9	58.3	111	3	1998	1822	664.4	34.525	63.9	58.3	112		
4	2215	2102	534.2	28.481	69.1	65.5	110	4	2443	2317	560.9	32.970	69.1	65.5	111		
5	2461	2376	462.4	26.938	70.2	67.7	109	5	2713	2619	485.5	31.184	70.2	67.7	110		
6	2742	2688	369.3	24.842	67.7	66.4	109	6	3023	2964	387.8	28.758	67.7	66.4	110		
1	1173	859	886.6	41.637	41.6	30.5	116	1	1282	939	926.9	47.577	41.6	30.5	117		
2	1672	1418	797.6	40.877	54.3	46.1	114	2	1828	1550	833.9	46.708	54.3	46.1	116		
3	2193	2000	696.0	39.695	63.9	58.3	113	3	2397	2186	727.6	45.358	63.9	58.3	114		
4	2681	2543	587.7	37.908	69.1	65.5	112	4	2930	2780	614.4	43.315	69.1	65.5	113		
5	2977	2874	508.6	35.854	70.2	67.7	111	5	3254	3142	531.8	40.969	70.2	67.7	112		
6	3318	3253	406.3	33.065	67.7	66.4	111	6	3627	3555	424.7	37.782	67.7	66.4	112		
1	1396	1023	967.2	54.056	41.6	30.5	118										
2	1990	1687	870.1	53.069	54.3	46.1	117										
3	2610	2380	759.3	51.535	63.9	58.3	115										
4	3190	3027	641.1	49.215	69.1	65.5	114										
5	3543	3421	554.9	46.549	70.2	67.7	113										
6	3949	3871	443.2	42.927	67.7	66.4	113										

- The A-weighted sound ratings shown have been calculated per AMCA International Standard 301.
- Values shown are for inlet LwiA sound power levels for installation type B - free inlet, ducted outlet.
- Performance certified is for installation type B - free inlet, ducted outlet.
- Performance ratings do not include the effects of appurtenances(accessories).
- Power rating (kW) does not include transmission losses.

Taeil Blower Co., LTD  
TDRD Series

TDRD-630

BACKWARD FAN  
FEG75



Wheel dia. 630 mm Tip Speed 0.033 x rpm Outlet Dim. 801 x 801 Outlet Area 0.6416 m<sup>2</sup> Class 1 1819 rpm Class 2 2425 rpm Not Applicable

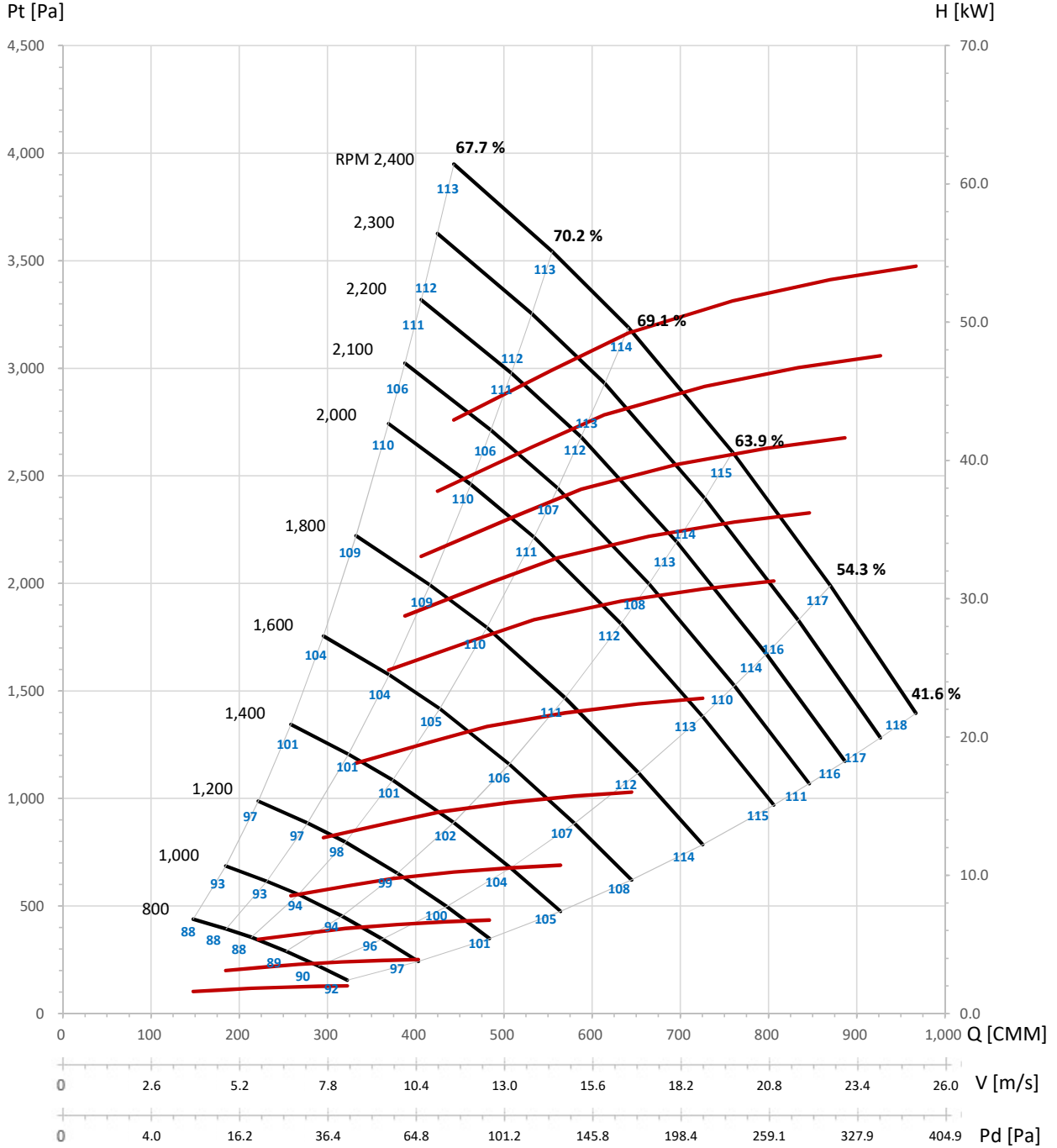

- The A-weighted sound ratings shown have been calculated per AMCA International Standard 301.  
 - Values shown are for inlet LwA sound power levels for installation type B - free inlet, ducted outlet.  
 - Performance certified is for installation type B - free inlet, ducted outlet.  
 - Performance ratings do not include the effects of appurtenances(accessories).  
 - Power rating (kW) does not include transmission losses.





Wheel dia. 710 mm Tip Speed 0.0372 × rpm Outlet Dim. 898 × 898 Outlet Area 0.8064 m<sup>2</sup> Class 1 1614 rpm Class 2 2152 rpm Not Applicable

Det.	N	Pt	Ps	Q	H	EtaT	EtaS	Lwi	Det.	N	Pt	Ps	Q	H	EtaT	EtaS	Lwi		
	[r/min]	[Pa]	[Pa]	[m <sup>3</sup> /min]	[kW]	[%]	[%]	[dB(A)]		[r/min]	[Pa]	[Pa]	[m <sup>3</sup> /min]	[kW]	[%]	[%]	[dB(A)]		
1	800	182	119	491.1	3.848	38.6	25.3	94		1000	284	186	613.9	7.516	38.6	25.3	100		
2		266	217	436.7	3.633	53.3	43.4	93			416	339	545.9	7.096	53.3	43.4	99		
3		356	318	383.2	3.571	63.6	56.8	91			557	497	479.1	6.975	63.6	56.8	97		
4		430	403	327.0	3.390	69.0	64.5	90			672	629	408.7	6.621	69.0	64.5	96		
5		496	476	273.8	3.184	70.8	68.0	88			774	744	342.2	6.219	70.8	68.0	94		
6		508	496	216.3	2.936	62.2	60.7	88			793	774	270.4	5.735	62.2	60.7	94		
7		520	512	179.3	2.514	61.6	60.6	87			812	799	224.1	4.910	61.6	60.6	93		
1	1200	409	268	736.7	12.987	38.6	25.3	105		1400	556	364	859.5	20.623	38.6	25.3	109		
2		600	488	655.1	12.262	53.3	43.4	103			816	665	764.3	19.472	53.3	43.4	107		
3		801	716	574.9	12.053	63.6	56.8	102			1091	974	670.7	19.140	63.6	56.8	106		
4		968	906	490.4	11.441	69.0	64.5	101			1317	1233	572.2	18.168	69.0	64.5	104		
5		1115	1071	410.6	10.746	70.8	68.0	99			1518	1458	479.1	17.064	70.8	68.0	103		
6		1142	1115	324.4	9.910	62.2	60.7	98			1555	1518	378.5	15.737	62.2	60.7	102		
7		1170	1151	269.0	8.485	61.6	60.6	98			1592	1567	313.8	13.474	61.6	60.6	102		
1	1500	639	418	920.9	25.365	38.6	25.3	110		1600	726	476	982.3	30.784	38.6	25.3	112		
2		937	763	818.9	23.949	53.3	43.4	109			1066	868	873.5	29.065	53.3	43.4	110		
3		1252	1119	718.6	23.541	63.6	56.8	107			1425	1273	766.5	28.570	63.6	56.8	109		
4		1512	1415	613.0	22.346	69.0	64.5	106			1721	1610	653.9	27.119	69.0	64.5	107		
5		1742	1674	513.3	20.988	70.8	68.0	104			1982	1905	547.5	25.472	70.8	68.0	106		
6		1785	1742	405.5	19.355	62.2	60.7	104			2031	1982	432.6	23.490	62.2	60.7	105		
7		1828	1798	336.2	16.572	61.6	60.6	103			2079	2046	358.6	20.113	61.6	60.6	105		
1	1700	820	537	1043.6	36.924	38.6	25.3	113		1800	919	602	1105.0	43.831	38.6	25.3	115		
2		1203	980	928.1	34.863	53.3	43.4	112			1349	1099	982.7	41.384	53.3	43.4	113		
3		1608	1437	814.4	34.269	63.6	56.8	110			1803	1611	862.3	40.679	63.6	56.8	112		
4		1942	1818	694.8	32.529	69.0	64.5	109			2178	2038	735.6	38.613	69.0	64.5	110		
5		2238	2150	581.7	30.553	70.8	68.0	107			2509	2411	616.0	36.268	70.8	68.0	109		
6		2292	2238	459.6	28.176	62.2	60.7	107			2570	2509	486.6	33.446	62.2	60.7	108		
7		2347	2310	381.0	24.124	61.6	60.6	106			2632	2590	403.4	28.637	61.6	60.6	108		
1	1900	1024	671	1166.4	51.550	38.6	25.3	116		2000	1135	743	1227.8	60.125	38.6	25.3	117		
2		1503	1224	1037.3	48.672	53.3	43.4	115			1665	1357	1091.9	56.769	53.3	43.4	116		
3		2009	1795	910.2	47.842	63.6	56.8	113			2226	1989	958.1	55.801	63.6	56.8	115		
4		2426	2270	776.5	45.413	69.0	64.5	112			2688	2516	817.4	52.968	69.0	64.5	113		
5		2795	2686	650.2	42.654	70.8	68.0	110			3097	2976	684.4	49.750	70.8	68.0	111		
6		2864	2796	513.7	39.336	62.2	60.7	110			3173	3098	540.7	45.880	62.2	60.7	111		
7		2932	2886	425.9	33.680	61.6	60.6	109			3249	3197	448.3	39.282	61.6	60.6	110		
1	2100	1251	820	1289.2	69.602	38.6	25.3	119											
2		1836	1496	1146.5	65.717	53.3	43.4	117											
3		2454	2192	1006.0	64.597	63.6	56.8	116											
4		2964	2774	858.3	61.317	69.0	64.5	114											
5		3414	3281	718.6	57.592	70.8	68.0	113											
6		3498	3415	567.7	53.111	62.2	60.7	112											
7		3582	3525	470.7	45.474	61.6	60.6	112											

- The A-weighted sound ratings shown have been calculated per AMCA International Standard 301.
- Values shown are for inlet LwA sound power levels for installation type B - free inlet, ducted outlet.
- Performance certified is for installation type B - free inlet, ducted outlet.
- Performance ratings do not include the effects of appurtenances(accessories).
- Power rating (kW) does not include transmission losses.



Wheel dia. 710 mm	Tip Speed 0.0372 × rpm	Outlet Dim. 898 × 898	Outlet Area 0.8064 m <sup>2</sup>	Class 1 1614 rpm	Class 2 2152 rpm	Not Applicable
-------------------	------------------------	-----------------------	-----------------------------------	------------------	------------------	----------------

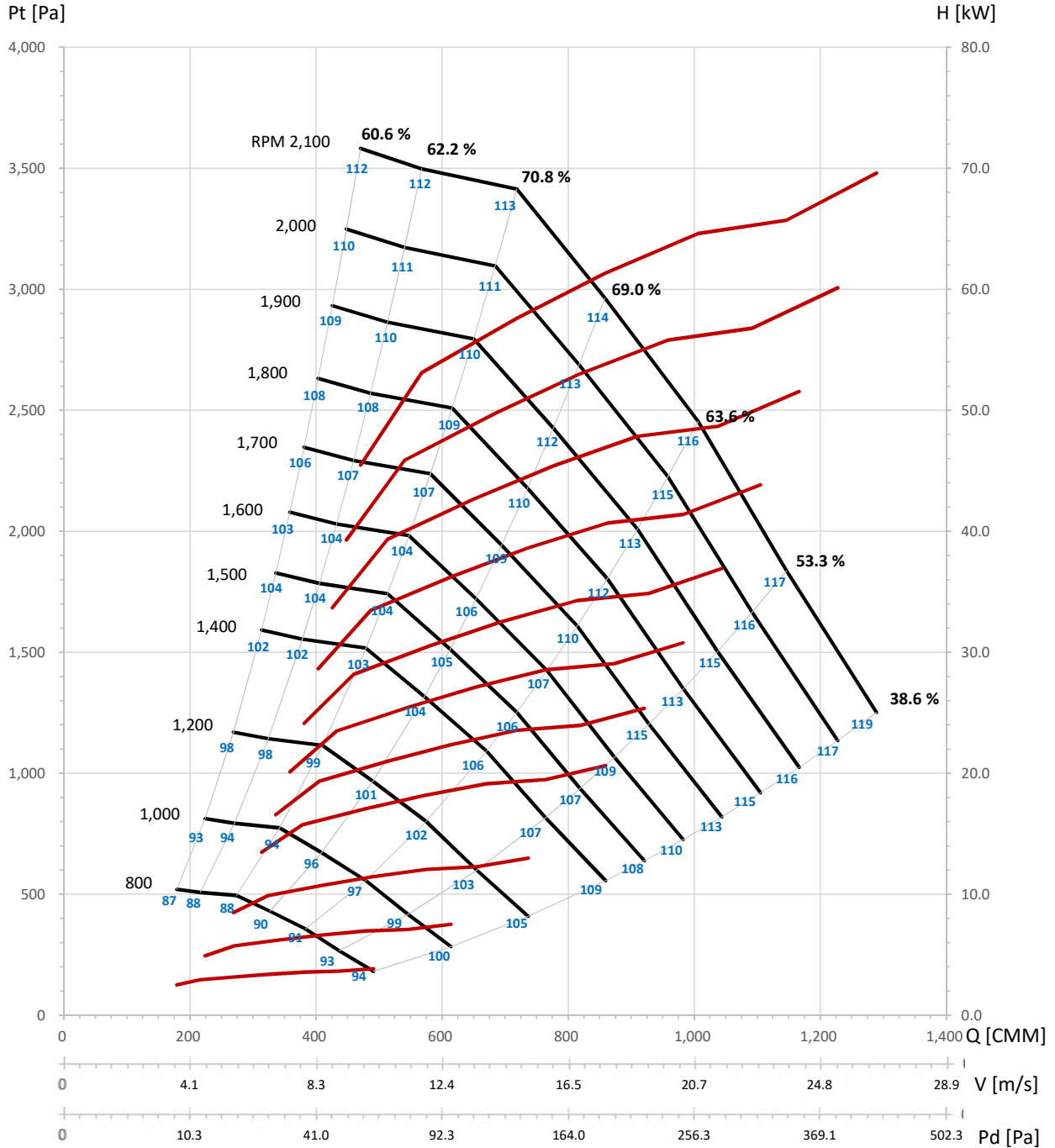

- The A-weighted sound ratings shown have been calculated per AMCA International Standard 301.  
 - Values shown are for inlet LwA sound power levels for installation type B - free inlet, ducted outlet.  
 - Performance certified is for installation type B - free inlet, ducted outlet.  
 - Performance ratings do not include the effects of appurtenances(accessories).  
 - Power rating (kW) does not include transmission losses.



Wheel dia. 800 mm	Tip Speed 0.0419 × rpm	Outlet Dim. 1007 × 1007	Outlet Area 1.0140 m <sup>2</sup>	Class 1 1432 rpm	Class 2 1910 rpm	Not Applicable
-------------------	------------------------	-------------------------	-----------------------------------	------------------	------------------	----------------

Det.	N	Pt	Ps	Q	H	EtaT	EtaS	Lwi	Det.	N	Pt	Ps	Q	H	EtaT	EtaS	Lwi
	[r/min]	[Pa]	[Pa]	[m <sup>3</sup> /min]	[kW]	[%]	[%]	[dB(A)]		[r/min]	[Pa]	[Pa]	[m <sup>3</sup> /min]	[kW]	[%]	[%]	[dB(A)]
1	700	176	115	612.2	4.649	38.6	25.3	95	1	800	230	151	699.6	6.940	38.6	25.3	98
2		258	210	544.4	4.389	53.3	43.4	93	2		337	275	622.1	6.552	53.3	43.4	96
3		345	308	477.7	4.315	63.6	56.8	92	3		451	403	545.9	6.441	63.6	56.8	95
4		417	390	407.5	4.096	69.0	64.5	90	4		545	510	465.7	6.114	69.0	64.5	94
5		480	462	341.2	3.847	70.8	68.0	89	5		627	603	390.0	5.742	70.8	68.0	92
6		492	480	269.6	3.548	62.2	60.7	88	6		643	627	308.1	5.295	62.2	60.7	91
7		504	496	223.5	3.037	61.6	60.6	88	7		658	648	255.4	4.534	61.6	60.6	91
1	900	291	191	787.1	9.881	38.6	25.3	101	1	1000	359	235	874.5	13.554	38.6	25.3	104
2		427	348	699.9	9.329	53.3	43.4	99	2		527	429	777.7	12.797	53.3	43.4	102
3		571	510	614.2	9.170	63.6	56.8	98	3		705	629	682.4	12.579	63.6	56.8	101
4		689	645	524.0	8.705	69.0	64.5	97	4		851	796	582.2	11.940	69.0	64.5	99
5		794	763	438.7	8.176	70.8	68.0	95	5		980	942	487.5	11.215	70.8	68.0	98
6		813	794	346.6	7.540	62.2	60.7	94	6		1004	980	385.1	10.343	62.2	60.7	97
7		833	820	287.3	6.456	61.6	60.6	94	7		1028	1012	319.3	8.855	61.6	60.6	97
1	1100	435	285	962.0	18.040	38.6	25.3	106	1	1200	517	339	1049.4	23.421	38.6	25.3	108
2		638	520	855.4	17.033	53.3	43.4	105	2		759	618	933.2	22.114	53.3	43.4	107
3		853	762	750.6	16.743	63.6	56.8	103	3		1015	906	818.9	21.737	63.6	56.8	106
4		1030	963	640.4	15.893	69.0	64.5	102	4		1225	1147	698.6	20.633	69.0	64.5	104
5		1186	1140	536.2	14.927	70.8	68.0	100	5		1412	1356	585.0	19.380	70.8	68.0	102
6		1215	1186	423.6	13.766	62.2	60.7	100	6		1446	1412	462.1	17.872	62.2	60.7	102
7		1244	1224	351.2	11.787	61.6	60.6	100	7		1481	1457	383.1	15.302	61.6	60.6	102
1	1300	607	398	1136.9	29.778	38.6	25.3	110	1	1400	704	461	1224.3	37.192	38.6	25.3	112
2		891	726	1011.0	28.116	53.3	43.4	109	2		1033	842	1088.8	35.116	53.3	43.4	111
3		1191	1064	887.1	27.637	63.6	56.8	108	3		1381	1234	955.4	34.517	63.6	56.8	109
4		1438	1346	756.8	26.233	69.0	64.5	106	4		1668	1561	815.1	32.765	69.0	64.5	108
5		1657	1592	633.7	24.640	70.8	68.0	104	5		1921	1846	682.4	30.774	70.8	68.0	106
6		1697	1657	500.6	22.723	62.2	60.7	104	6		1968	1922	539.2	28.380	62.2	60.7	106
7		1738	1710	415.1	19.455	61.6	60.6	104	7		2016	1983	447.0	24.299	61.6	60.6	106
1	1500	808	529	1311.8	45.745	38.6	25.3	114	1	1600	920	602	1399.2	55.517	38.6	25.3	115
2		1186	966	1166.5	43.191	53.3	43.4	112	2		1349	1099	1244.3	52.418	53.3	43.4	114
3		1585	1416	1023.6	42.455	63.6	56.8	111	3		1804	1611	1091.8	51.524	63.6	56.8	113
4		1914	1792	873.3	40.299	69.0	64.5	109	4		2178	2038	931.5	48.908	69.0	64.5	111
5		2205	2119	731.2	37.851	70.8	68.0	108	5		2509	2411	779.9	45.937	70.8	68.0	109
6		2260	2206	577.7	34.906	62.2	60.7	107	6		2571	2510	616.2	42.363	62.2	60.7	109
7		2314	2277	478.9	29.887	61.6	60.6	107	7		2633	2591	510.8	36.272	61.6	60.6	109
1	1700	1038	680	1486.7	66.591	38.6	25.3	117	1	1800	1164	762	1574.1	79.047	38.6	25.3	118
2		1523	1241	1322.1	62.873	53.3	43.4	115	2		1708	1391	1399.8	74.634	53.3	43.4	117
3		2036	1819	1160.1	61.802	63.6	56.8	114	3		2283	2039	1228.3	73.362	63.6	56.8	116
4		2459	2301	989.7	58.664	69.0	64.5	113	4		2757	2580	1047.9	69.637	69.0	64.5	114
5		2833	2722	828.7	55.100	70.8	68.0	111	5		3176	3052	877.4	65.407	70.8	68.0	112
6		2902	2833	654.7	50.813	62.2	60.7	110	6		3254	3176	693.2	60.318	62.2	60.7	112
7		2972	2925	542.8	43.507	61.6	60.6	110	7		3332	3279	574.7	51.645	61.6	60.6	112
1	1900	1297	849	1661.6	92.967	38.6	25.3	120									
2		1903	1550	1477.6	87.777	53.3	43.4	118									
3		2544	2272	1296.6	86.281	63.6	56.8	117									
4		3072	2874	1106.1	81.900	69.0	64.5	115									
5		3539	3400	926.2	76.925	70.8	68.0	114									
6		3625	3539	731.7	70.940	62.2	60.7	113									
7		3712	3653	606.6	60.739	61.6	60.6	113									

- The A-weighted sound ratings shown have been calculated per AMCA International Standard 301.
- Values shown are for inlet LwiA sound power levels for installation type B - free inlet, ducted outlet.
- Performance certified is for installation type B - free inlet, ducted outlet.
- Performance ratings do not include the effects of appurtenances(accessories).
- Power rating (kW) does not include transmission losses.



Wheel dia. 800 mm	Tip Speed 0.0419 × rpm	Outlet Dim. 1007 × 1007	Outlet Area 1.0140 m <sup>2</sup>	Class 1 1432 rpm	Class 2 1910 rpm	Not Applicable
-------------------	------------------------	-------------------------	-----------------------------------	------------------	------------------	----------------

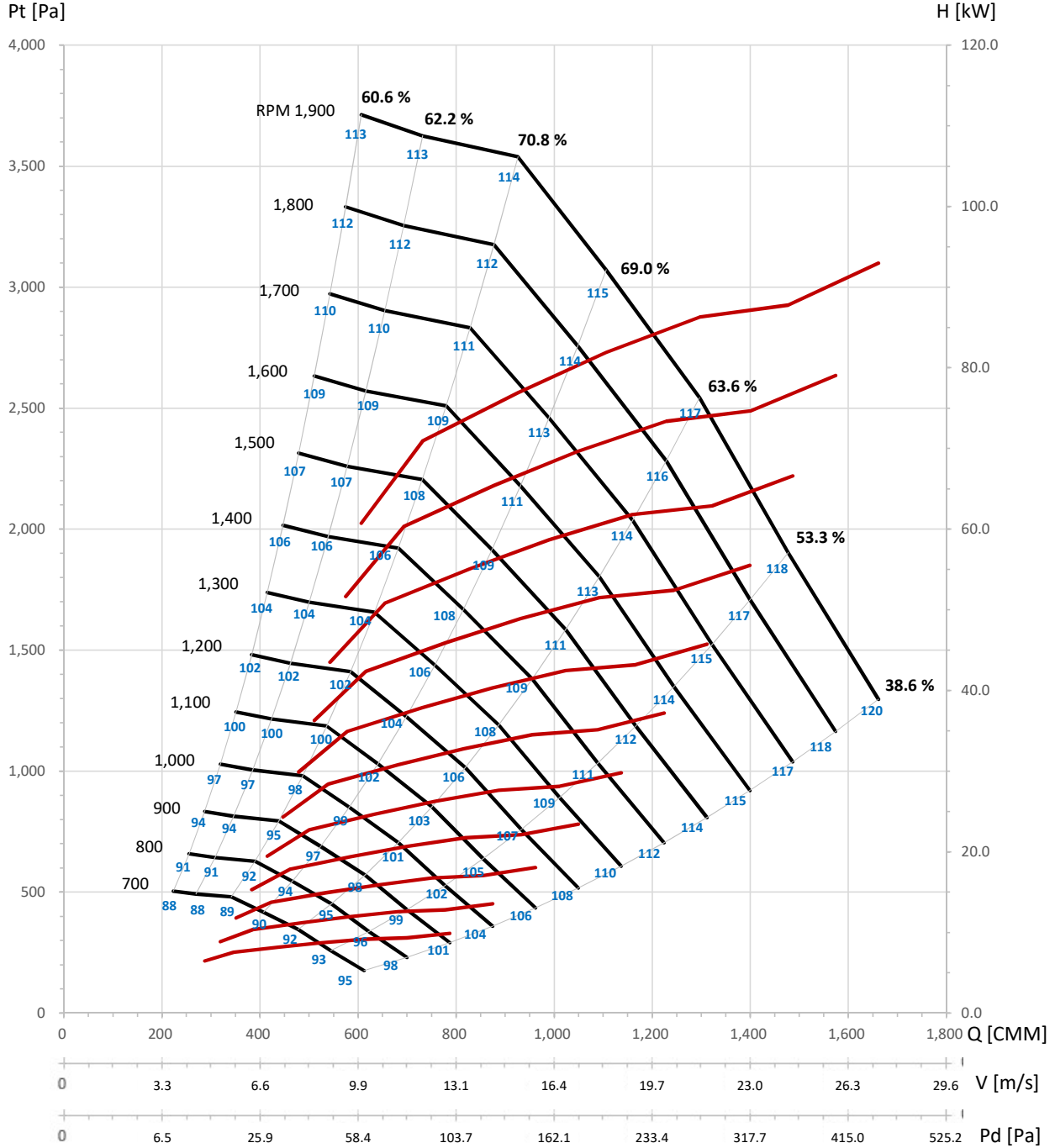

- The A-weighted sound ratings shown have been calculated per AMCA International Standard 301.  
 - Values shown are for inlet LwA sound power levels for installation type B - free inlet, ducted outlet.  
 - Performance certified is for installation type B - free inlet, ducted outlet.  
 - Performance ratings do not include the effects of appurtenances(accessories).  
 - Power rating (kW) does not include transmission losses.



Wheel dia. 900 mm	Tip Speed 0.0471 × rpm	Outlet Dim' 1130 × 1130	Outlet Area 1.2769 m <sup>2</sup>	Class 1 1273 rpm	Class 2 1698 rpm	Not Applicable
-------------------	------------------------	-------------------------	-----------------------------------	------------------	------------------	----------------

Det.	N								Det.	N							
	[r/min]	Pt [Pa]	Ps [Pa]	Q [m <sup>3</sup> /min]	H [kW]	EtaT [%]	EtaS [%]	Lwi [dB(A)]		[r/min]	Pt [Pa]	Ps [Pa]	Q [m <sup>3</sup> /min]	H [kW]	EtaT [%]	EtaS [%]	Lwi [dB(A)]
1	114	74	622.6	3.053	38.6	25.3	90	1	164	107	747.1	5.276	38.6	25.3	94		
2	167	136	553.6	2.883	53.3	43.4	88	2	240	196	664.4	4.981	53.3	43.4	93		
3	223	199	485.8	2.834	63.6	56.8	87	3	321	287	583.0	4.896	63.6	56.8	91		
4	269	252	414.5	2.690	69.0	64.5	86	4	388	363	497.4	4.648	69.0	64.5	90		
5	310	298	347.0	2.526	70.8	68.0	84	5	447	429	416.4	4.365	70.8	68.0	88		
6	318	310	274.2	2.330	62.2	60.7	83	6	458	447	329.0	4.026	62.2	60.7	88		
7	325	320	227.3	1.995	61.6	60.6	83	7	469	461	272.8	3.447	61.6	60.6	88		
1	223	146	871.6	8.378	38.6	25.3	98	1	291	191	996.1	12.505	38.6	25.3	101		
2	327	266	775.1	7.910	53.3	43.4	97	2	427	348	885.8	11.807	53.3	43.4	100		
3	437	390	680.1	7.775	63.6	56.8	95	3	571	510	777.3	11.606	63.6	56.8	99		
4	528	494	580.2	7.380	69.0	64.5	94	4	689	645	663.1	11.017	69.0	64.5	97		
5	608	584	485.8	6.932	70.8	68.0	92	5	794	763	555.3	10.348	70.8	68.0	96		
6	623	608	383.8	6.393	62.2	60.7	92	6	813	794	438.7	9.543	62.2	60.7	95		
7	638	628	318.2	5.474	61.6	60.6	92	7	833	820	363.7	8.170	61.6	60.6	95		
1	368	241	1120.6	17.806	38.6	25.3	104	1	455	298	1245.2	24.425	38.6	25.3	107		
2	540	440	996.6	16.812	53.3	43.4	103	2	667	543	1107.3	23.061	53.3	43.4	106		
3	722	645	874.5	16.525	63.6	56.8	102	3	892	797	971.6	22.668	63.6	56.8	104		
4	872	816	746.0	15.686	69.0	64.5	100	4	1077	1008	828.9	21.517	69.0	64.5	103		
5	1005	966	624.7	14.733	70.8	68.0	99	5	1241	1192	694.1	20.210	70.8	68.0	101		
6	1030	1005	493.5	13.587	62.2	60.7	98	6	1271	1241	548.3	18.638	62.2	60.7	101		
7	1054	1037	409.1	11.633	61.6	60.6	98	7	1301	1281	454.6	15.958	61.6	60.6	101		
1	550	360	1369.7	32.509	38.6	25.3	110	1	655	429	1494.2	42.206	38.6	25.3	112		
2	807	658	1218.0	30.694	53.3	43.4	108	2	961	783	1328.7	39.850	53.3	43.4	111		
3	1079	964	1068.8	30.171	63.6	56.8	107	3	1284	1147	1166.0	39.171	63.6	56.8	109		
4	1303	1219	911.8	28.639	69.0	64.5	105	4	1551	1451	994.7	37.182	69.0	64.5	108		
5	1501	1442	763.5	26.900	70.8	68.0	104	5	1786	1717	832.9	34.923	70.8	68.0	106		
6	1538	1501	603.2	24.807	62.2	60.7	103	6	1830	1787	658.0	32.206	62.2	60.7	106		
7	1575	1550	500.1	21.240	61.6	60.6	103	7	1874	1844	545.5	27.575	61.6	60.6	105		
1	768	503	1618.7	53.661	38.6	25.3	114	1	891	584	1743.2	67.021	38.6	25.3	116		
2	1127	918	1439.5	50.665	53.3	43.4	113	2	1308	1065	1550.2	63.280	53.3	43.4	114		
3	1507	1346	1263.1	49.802	63.6	56.8	111	3	1748	1561	1360.3	62.201	63.6	56.8	113		
4	1820	1703	1077.6	47.273	69.0	64.5	110	4	2111	1975	1160.5	59.043	69.0	64.5	111		
5	2097	2015	902.3	44.402	70.8	68.0	108	5	2432	2337	971.7	55.456	70.8	68.0	110		
6	2148	2097	712.8	40.947	62.2	60.7	107	6	2491	2432	767.7	51.142	62.2	60.7	109		
7	2199	2164	591.0	35.059	61.6	60.6	107	7	2551	2510	636.4	43.788	61.6	60.6	109		
1	1164	762	1992.2	100.044	38.6	25.3	119										
2	1708	1391	1771.7	94.459	53.3	43.4	118										
3	2283	2039	1554.6	92.849	63.6	56.8	116										
4	2757	2580	1326.3	88.134	69.0	64.5	115										
5	3176	3052	1110.5	82.780	70.8	68.0	113										
6	3254	3176	877.3	76.340	62.2	60.7	112										
7	3332	3279	727.4	65.363	61.6	60.6	112										

- The A-weighted sound ratings shown have been calculated per AMCA International Standard 301.
- Values shown are for inlet LwA sound power levels for installation type B - free inlet, ducted outlet.
- Performance certified is for installation type B - free inlet, ducted outlet.
- Performance ratings do not include the effects of appurtenances(accessories).
- Power rating (kW) does not include transmission losses.



Wheel dia. 900 mm	Tip Speed 0.0471 × rpm	Outlet Dim' 1130 × 1130	Outlet Area 1.2769 m <sup>2</sup>	Class 1 1273 rpm	Class 2 1698 rpm	Not Applicable
-------------------	------------------------	-------------------------	-----------------------------------	------------------	------------------	----------------

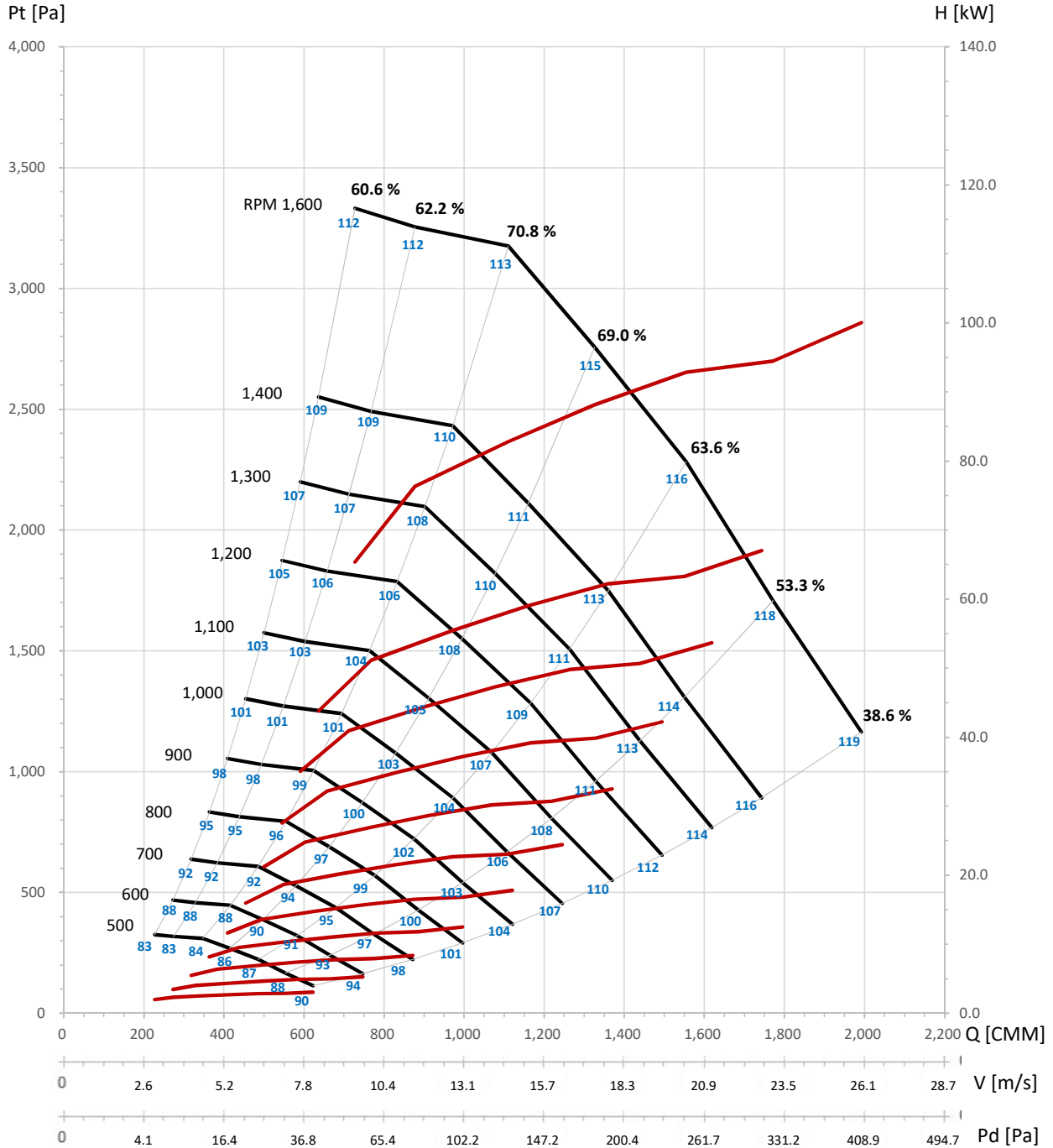

- The A-weighted sound ratings shown have been calculated per AMCA International Standard 301.
- Values shown are for inlet LwA sound power levels for installation type B - free inlet, ducted outlet.
- Performance certified is for installation type B - free inlet, ducted outlet.
- Performance ratings do not include the effects of appurtenances(accessories).
- Power rating (kW) does not include transmission losses.



Wheel dia. 1000 mm | Tip Speed 0.0524 × rpm | Outlet Dim. 1267 × 1267 | Outlet Area 1.6053 m<sup>2</sup> | Class 1 1146 rpm | Class 2 1528 rpm | Not Applicable

Det.	N [r/min]	Pt [Pa]	Ps [Pa]	Q [m <sup>3</sup> /min]	H [kW]	EtaT [%]	EtaS [%]	Lwi [dB(A)]	Det.	N [r/min]	Pt [Pa]	Ps [Pa]	Q [m <sup>3</sup> /min]	H [kW]	EtaT [%]	EtaS [%]	Lwi [dB(A)]
1	140	92	854.0	5.170	38.6	25.3	93	1	202	132	1024.8	8.935	38.6	25.3	98		
2	206	168	759.5	4.882	53.3	43.4	91	2	297	242	911.3	8.436	53.3	43.4	96		
3	275	246	666.4	4.799	63.6	56.8	90	3	396	354	799.7	8.292	63.6	56.8	95		
4	332	311	668.5	4.555	69.0	64.5	89	4	479	448	682.2	7.871	69.0	64.5	93		
5	383	368	476.0	4.278	70.8	68.0	87	5	551	530	571.2	7.393	70.8	68.0	91		
6	392	383	376.1	3.945	62.2	60.7	86	6	565	551	451.3	6.818	62.2	60.7	91		
7	402	395	311.8	3.378	61.6	60.6	86	7	578	569	374.2	5.837	61.6	60.6	91		
1	275	180	1195.6	14.188	38.6	25.3	101	1	359	235	1366.4	21.178	38.6	25.3	105		
2	404	329	1063.2	13.396	53.3	43.4	100	2	527	429	1215.1	19.996	53.3	43.4	103		
3	539	482	933.0	13.167	63.6	56.8	98	3	705	629	1066.3	19.655	63.6	56.8	102		
4	651	610	795.9	12.499	69.0	64.5	97	4	851	796	909.7	18.657	69.0	64.5	101		
5	750	721	666.5	11.739	70.8	68.0	95	5	980	942	761.7	17.524	70.8	68.0	99		
6	769	751	526.5	10.826	62.2	60.7	95	6	1004	980	601.7	16.160	62.2	60.7	98		
7	787	775	436.5	9.269	61.6	60.6	95	7	1028	1012	498.9	13.837	61.6	60.6	98		
1	455	298	1537.2	30.154	38.6	25.3	108	1	561	368	1708.0	41.363	38.6	25.3	110		
2	667	543	1367.0	28.471	53.3	43.4	106	2	824	671	1518.9	39.054	53.3	43.4	109		
3	892	797	1199.5	27.985	63.6	56.8	105	3	1101	983	1332.8	38.389	63.6	56.8	108		
4	1077	1008	1023.4	26.564	69.0	64.5	103	4	1330	1244	1137.1	36.439	69.0	64.5	106		
5	1241	1192	856.9	24.951	70.8	68.0	102	5	1532	1472	952.1	34.226	70.8	68.0	104		
6	1271	1241	677.0	23.010	62.2	60.7	101	6	1569	1532	752.2	31.563	62.2	60.7	104		
7	1301	1281	561.2	19.701	61.6	60.6	101	7	1607	1581	623.6	27.025	61.6	60.6	104		
1	679	445	1878.8	55.055	38.6	25.3	113	1	808	529	2049.6	71.476	38.6	25.3	115		
2	997	812	1670.8	51.981	53.3	43.4	112	2	1186	966	1822.7	67.486	53.3	43.4	114		
3	1332	1190	1466.1	51.095	63.6	56.8	110	3	1585	1416	1599.4	66.336	63.6	56.8	112		
4	1609	1505	1250.8	48.501	69.0	64.5	109	4	1914	1792	1364.5	62.967	69.0	64.5	111		
5	1853	1781	1047.3	45.555	70.8	68.0	107	5	2205	2119	1142.5	59.142	70.8	68.0	109		
6	1899	1854	827.4	42.011	62.2	60.7	106	6	2260	2206	902.6	54.541	62.2	60.7	109		
7	1944	1913	685.9	35.970	61.6	60.6	106	7	2314	2277	748.3	46.699	61.6	60.6	109		
1	949	621	2220.4	90.876	38.6	25.3	117	1	1100	721	2391.2	113.501	38.6	25.3	119		
2	1392	1134	1974.6	85.802	53.3	43.4	116	2	1614	1315	2126.5	107.165	53.3	43.4	117		
3	1861	1662	1732.7	84.340	63.6	56.8	114	3	2158	1928	1866.0	105.339	63.6	56.8	116		
4	2247	2103	1478.2	80.058	69.0	64.5	113	4	2606	2438	1591.9	99.990	69.0	64.5	115		
5	2588	2487	1237.7	75.194	70.8	68.0	111	5	3002	2885	1332.9	93.916	70.8	68.0	113		
6	2652	2589	977.8	69.344	62.2	60.7	111	6	3076	3002	1053.0	86.610	62.2	60.7	112		
7	2715	2672	810.7	59.373	61.6	60.6	111	7	3149	3099	873.0	74.156	61.6	60.6	112		
1	1263	827	2562.0	139.602	38.6	25.3	121										
2	1853	1509	2278.4	131.808	53.3	43.4	119										
3	2477	2213	1999.2	129.562	63.6	56.8	118										
4	2991	2799	1705.6	122.983	69.0	64.5	116										
5	3446	3311	1428.1	115.512	70.8	68.0	115										
6	3531	3447	1128.3	106.526	62.2	60.7	114										
7	3615	3558	935.4	91.208	61.6	60.6	114										

- The A-weighted sound ratings shown have been calculated per AMCA International Standard 301.
- Values shown are for inlet LwA sound power levels for installation type B - free inlet, ducted outlet.
- Performance certified is for installation type B - free inlet, ducted outlet.
- Performance ratings do not include the effects of appurtenances(accessories).
- Power rating (kW) does not include transmission losses.



Wheel dia. 1000 mm	Tip Speed 0.0524 × rpm	Outlet Dim. 1267 × 1267	Outlet Area 1.6053 m <sup>2</sup>	Class 1 1146 rpm	Class 2 1528 rpm	Not Applicable
--------------------	------------------------	-------------------------	-----------------------------------	------------------	------------------	----------------

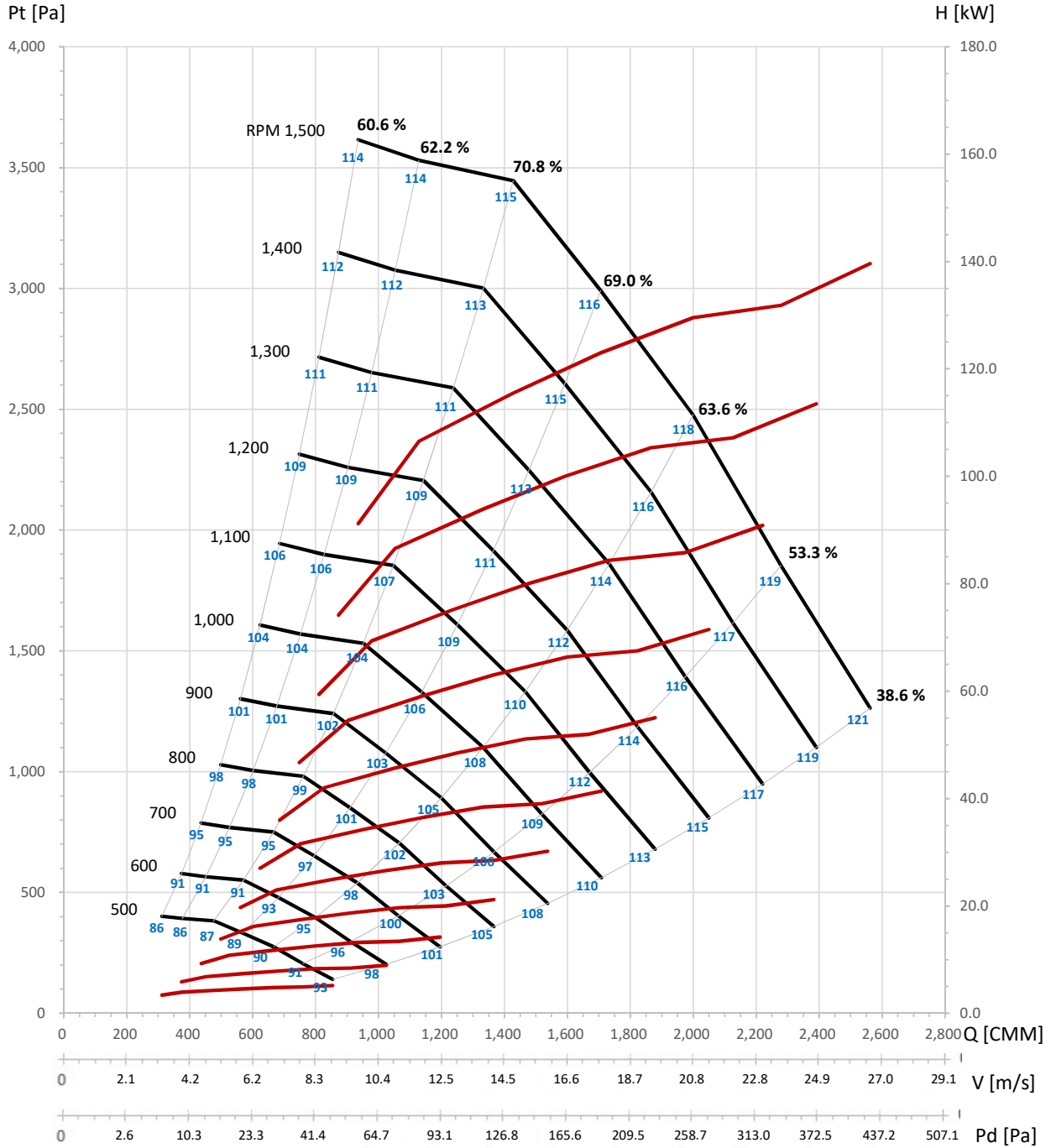

- The A-weighted sound ratings shown have been calculated per AMCA International Standard 301.
- Values shown are for inlet LwA sound power levels for installation type B - free inlet, ducted outlet.
- Performance certified is for installation type B - free inlet, ducted outlet.
- Performance ratings do not include the effects of appurtenances(accessories).
- Power rating (kW) does not include transmission losses.





OFFICE : 50, Jeongmal-gil, Docheon-myeon, Changnyeong-gun, Gyeongsangnam-do, Korea

TEL : 82 055-521-7300 / FAX : 82 055-521-6977

Homepage : [www.tlbfmg.co.kr](http://www.tlbfmg.co.kr) / E-mail : [Sales@tae-il.co.kr](mailto:Sales@tae-il.co.kr)