



(주) 태일송풍기  
TAE IL BLOWER MFG. Co.,Ltd.

**TSFD**

**DOUBLE INLET CENTRIFUGAL FAN With FORWARD WHEELS**

## Forward Double Inlet Centrifugal Fan TSFD Series



Tae il Blower Mfg. Co., LTD certifies that the TSFD Series shown herein are licensed to bear the AMCA Seal. The ratings shown are based on tests and procedures performed in accordance with AMCA Publication 211 and AMCA Publication 311 and comply with the requirements of the AMCA Certified Ratings Program.



TSFD Series는 AMCA 인증 제품입니다.

Forward Type의 양흡입 원심팬으로 50 ~ 150 mmAq의 정압에서 보다 많은 풍량을 요구하는 경우 사용되는 제품입니다.

중앙집중 냉/난방설비에 주로 사용되며, 강제 급/배기, 집진, 제진 등의 설비에 사용됩니다.



# Forward Double Inlet Centrifugal Fan

# TSFD Series

## 1. 표준 외형도

Standard Shape of Forward Double Inlet Centrifugal Fan

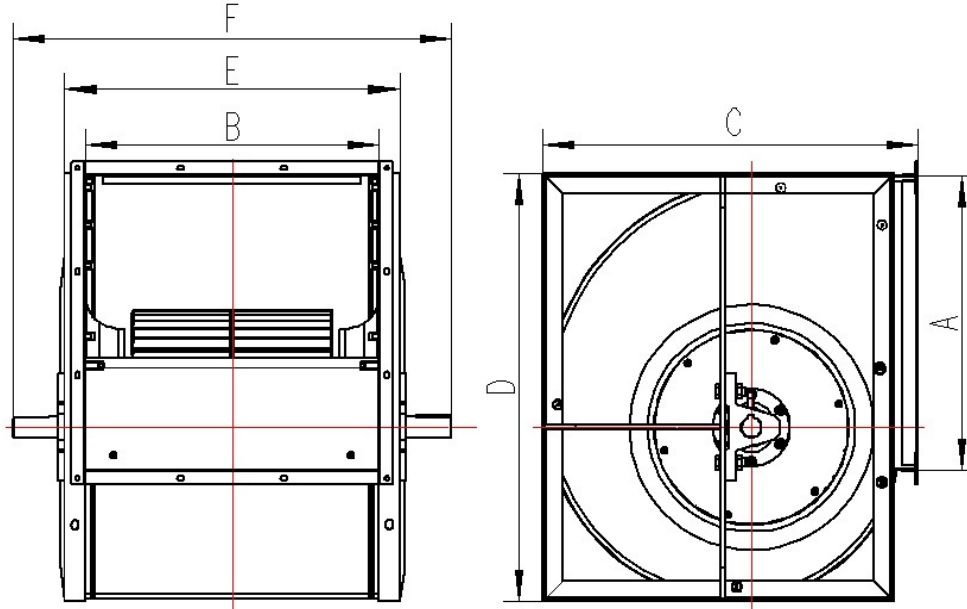

## 2. Fan 치수표

NO	Model Name	Wheel Dia.	A	B	C	D	E	F
1	TSFD-280	280	361	361	466	518	417	580
2	TSFD-315	315	404	404	518	578	460	625
3	TSFD-355	355	453	453	578	655	509	685
4	TSFD-400	400	507	507	651	736	563	790
5	TSFD-450	450	569	569	726	827	625	850
6	TSFD-500	500	638	638	800	918	718	920
7	TSFD-560	560	715	715	893	1030	815	1070
8	TSFD-630	630	801	801	999	1157	901	1155
9	TSFD-710	710	898	898	1121	1303	998	1290
10	TSFD-800	800	1007	1007	1250	1468	1107	1450
11	TSFD-900	900	1130	1130	1408	1648	1250	1570
12	TSFD-1000	1000	1267	1267	1542	1810	1387	1700

Taeil Blower Co., LTD  
TSFD Series

TSFD-280

SIROCCO FAN  
FEG 71



Wheel dia. 280 mm | Tip Speed = 0.0147 × rpm | Outlet Dim. 361×361 | Outlet Area 0.1303 m<sup>2</sup> | Class 1 4093 rpm | Class 2 5457 rpm | Not Applicable

Det.	N	Pt	Ps	Q	H	EtaT	EtaS	Lwi	Det.	N	Pt	Ps	Q	H	EtaT	EtaS	Lwi
	[r/min]	[Pa]	[Pa]	[m <sup>3</sup> /min]	[kW]	[%]	[%]	[dB(A)]		[r/min]	[Pa]	[Pa]	[m <sup>3</sup> /min]	[kW]	[%]	[%]	[dB(A)]
1	700	168	108	78.2	0.475	46.1	29.6	79	1	800	220	141	89.3	0.709	46.1	29.6	82
2		176	129	69.2	0.398	51.0	37.3	77	2		230	168	79.1	0.594	51.0	37.3	80
3		179	142	60.9	0.331	54.8	43.6	75	3		234	186	69.6	0.494	54.8	43.6	78
4		177	152	50.9	0.259	58.0	49.6	73	4		232	198	58.2	0.387	58.0	49.6	76
5		170	151	42.9	0.210	57.5	51.4	73	5		221	198	49.0	0.314	57.5	51.4	76
6		162	150	35.1	0.169	55.9	51.7	73	6		211	195	40.1	0.252	55.9	51.7	76
7		153	146	26.3	0.123	54.3	51.9	74	7		200	191	30.0	0.184	54.3	51.9	77
1	900	278	178	100.5	1.010	46.1	29.6	85	1	1000	344	220	111.7	1.385	46.1	29.6	87
2		291	213	89.0	0.845	51.0	37.3	83	2		359	262	98.9	1.160	51.0	37.3	85
3		296	235	78.3	0.703	54.8	43.6	80	3		365	290	87.0	0.965	54.8	43.6	83
4		293	251	65.5	0.551	58.0	49.6	78	4		362	309	72.8	0.756	58.0	49.6	81
5		280	250	55.1	0.447	57.5	51.4	79	5		346	309	61.3	0.613	57.5	51.4	81
6		267	247	45.1	0.359	55.9	51.7	79	6		330	305	50.1	0.492	55.9	51.7	81
7		253	242	33.8	0.262	54.3	51.9	80	7		312	298	37.5	0.359	54.3	51.9	82
1	1100	416	267	122.8	1.844	46.1	29.6	90	1	1200	495	317	134.0	2.394	46.1	29.6	92
2		435	317	108.8	1.544	51.0	37.3	87	2		517	378	118.7	2.004	51.0	37.3	89
3		442	351	95.7	1.284	54.8	43.6	85	3		526	418	104.4	1.667	54.8	43.6	87
4		438	374	80.0	1.006	58.0	49.6	83	4		521	446	87.3	1.306	58.0	49.6	85
5		419	374	67.4	0.816	57.5	51.4	83	5		498	445	73.5	1.060	57.5	51.4	85
6		399	369	55.1	0.655	55.9	51.7	84	6		475	439	60.1	0.850	55.9	51.7	86
7		378	361	41.3	0.478	54.3	51.9	84	7		450	430	45.0	0.621	54.3	51.9	86
1	1300	581	372	145.2	3.044	46.1	29.6	94	1	1400	673	432	156.3	3.802	46.1	29.6	95
2		607	443	128.6	2.548	51.0	37.3	91	2		704	514	138.5	3.182	51.0	37.3	93
3		617	491	113.1	2.119	54.8	43.6	89	3		716	569	121.8	2.647	54.8	43.6	91
4		611	523	94.6	1.660	58.0	49.6	87	4		709	607	101.9	2.074	58.0	49.6	89
5		585	522	79.6	1.348	57.5	51.4	87	5		678	606	85.8	1.683	57.5	51.4	89
6		558	516	65.1	1.081	55.9	51.7	88	6		647	598	70.1	1.350	55.9	51.7	89
7		528	504	48.8	0.790	54.3	51.9	88	7		612	585	52.5	0.986	54.3	51.9	90
1	1500	773	496	167.5	4.676	46.1	29.6	97	1	1600	880	564	178.7	5.675	46.1	29.6	99
2		808	590	148.4	3.914	51.0	37.3	95	2		919	672	158.3	4.750	51.0	37.3	96
3		822	653	130.5	3.256	54.8	43.6	92	3		935	743	139.2	3.951	54.8	43.6	94
4		814	696	109.1	2.551	58.0	49.6	90	4		926	792	116.4	3.096	58.0	49.6	92
5		779	695	91.9	2.070	57.5	51.4	91	5		886	791	98.0	2.513	57.5	51.4	92
6		742	687	75.1	1.660	55.9	51.7	91	6		845	781	80.1	2.015	55.9	51.7	92
7		703	672	56.3	1.213	54.3	51.9	92	7		800	764	60.0	1.472	54.3	51.9	93
1	1700	993	637	189.8	6.807	46.1	29.6	100	1	1800	1113	714	201.0	8.080	46.1	29.6	101
2		1038	758	168.2	5.698	51.0	37.3	98	2		1164	850	178.1	6.764	51.0	37.3	99
3		1056	839	147.9	4.740	54.8	43.6	95	3		1183	941	156.6	5.626	54.8	43.6	97
4		1046	894	123.7	3.713	58.0	49.6	93	4		1172	1003	131.0	4.408	58.0	49.6	95
5		1000	893	104.1	3.014	57.5	51.4	94	5		1121	1001	110.3	3.578	57.5	51.4	95
6		954	882	85.1	2.417	55.9	51.7	94	6		1069	989	90.2	2.869	55.9	51.7	95
7		903	863	63.8	1.766	54.3	51.9	95	7		1012	967	67.5	2.096	54.3	51.9	96
1	1900	1240	795	212.2	9.503	46.1	29.6	103	1	2000	1374	881	223.3	11.083	46.1	29.6	104
2		1297	947	187.9	7.955	51.0	37.3	100	2		1437	1050	197.8	9.278	51.0	37.3	102
3		1318	1048	165.3	6.617	54.8	43.6	98	3		1461	1162	174.0	7.718	54.8	43.6	99
4		1306	1117	138.2	5.184	58.0	49.6	96	4		1447	1238	145.5	6.046	58.0	49.6	97
5		1249	1115	116.4	4.207	57.5	51.4	96	5		1384	1236	122.5	4.907	57.5	51.4	97
6		1191	1102	95.2	3.374	55.9	51.7	97	6		1320	1221	100.2	3.935	55.9	51.7	98
7		1128	1078	71.3	2.465	54.3	51.9	97	7		1250	1194	75.0	2.875	54.3	51.9	99

- The A-weighted sound ratings shown have been calculated per AMCA International Standard 301.
- Values shown are for inlet LwiA sound power levels for installation type B - free inlet, ducted outlet.
- Performance certified is for installation type B - free inlet, ducted outlet.
- Performance ratings do not include the effects of appurtenances(accessories).
- Power rating (kW) does not include transmission losses.

Taeil Blower Co., LTD  
TSFD Series

TSFD-280

SIROCCO FAN  
FEG 71



Wheel dia. 280 mm Tip Speed = 0.0147 × rpm Outlet Dim. 361×361 Outlet Area 0.1303 m<sup>2</sup> Class 1 4099 rpm Class 2 5457 rpm Not Applicable

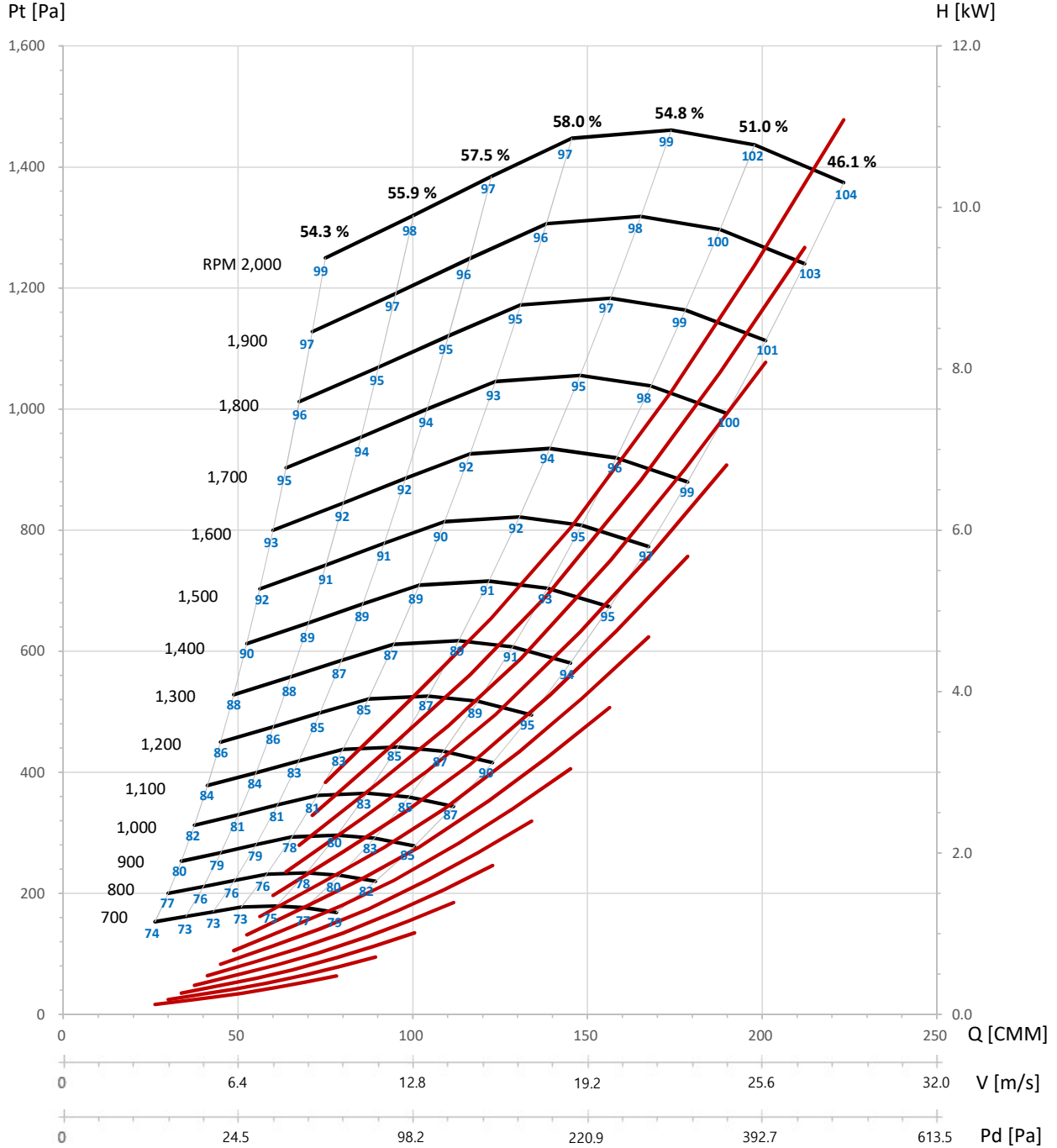

- The A-weighted sound ratings shown have been calculated per AMCA International Standard 301.
- Values shown are for inlet LwA sound power levels for installation type B - free inlet, ducted outlet.
- Performance certified is for installation type B - free inlet, ducted outlet.
- Performance ratings do not include the effects of appurtenances(accessories).
- Power rating (kW) does not include transmission losses.

Taeil Blower Co., LTD  
TSFD Series

TSFD-315

SIROCCO FAN  
FEG 67



Wheel dia. 315 mm | Tip Speed = 0.0165 × rpm | Outlet Dim. 404×404 | Outlet Area 0.1632 m<sup>2</sup> | Class 1 3638 rpm | Class 2 4850 rpm | Not Applicable

Det.	N	Pt	Ps	Q	H	EtaT	EtaS	Lwi	Det.	N	Pt	Ps	Q	H	EtaT	EtaS	Lwi
	[r/min]	[Pa]	[Pa]	[m <sup>3</sup> /min]	[kW]	[%]	[%]	[dB(A)]		[r/min]	[Pa]	[Pa]	[m <sup>3</sup> /min]	[kW]	[%]	[%]	[dB(A)]
1	600	154	99	93.5	0.521	46.1	29.6	79	1	700	210	135	109.1	0.828	46.1	29.6	83
2		161	118	82.8	0.436	51.0	37.3	77	2		220	161	96.6	0.693	51.0	37.3	81
3		164	131	72.8	0.363	54.8	43.6	75	3		223	178	85.0	0.577	54.8	43.6	78
4		163	139	60.9	0.284	58.0	49.6	73	4		221	189	71.1	0.452	58.0	49.6	76
5		156	139	51.3	0.231	57.5	51.4	73	5		212	189	59.8	0.367	57.5	51.4	76
6		148	137	41.9	0.185	55.9	51.7	73	6		202	187	48.9	0.294	55.9	51.7	77
7		140	134	31.4	0.135	54.3	51.9	74	7		191	183	36.6	0.215	54.3	51.9	77
1	800	275	176	124.6	1.236	46.1	29.6	86	1	900	347	223	140.2	1.760	46.1	29.6	88
2		287	210	110.4	1.035	51.0	37.3	84	2		363	265	124.2	1.473	51.0	37.3	86
3		292	232	97.1	0.861	54.8	43.6	81	3		369	294	109.3	1.225	54.8	43.6	84
4		289	247	81.2	0.674	58.0	49.6	79	4		366	313	91.4	0.960	58.0	49.6	82
5		277	247	68.4	0.547	57.5	51.4	79	5		350	313	76.9	0.779	57.5	51.4	82
6		264	244	55.9	0.439	55.9	51.7	80	6		334	309	62.9	0.625	55.9	51.7	82
7		250	239	41.9	0.321	54.3	51.9	80	7		316	302	47.1	0.456	54.3	51.9	83
1	1000	429	275	155.8	2.414	46.1	29.6	91	1	1100	519	333	171.4	3.213	46.1	29.6	93
2		448	328	138.0	2.021	51.0	37.3	89	2		543	396	151.8	2.689	51.0	37.3	91
3		456	363	121.4	1.681	54.8	43.6	86	3		552	439	133.5	2.237	54.8	43.6	88
4		452	386	101.5	1.317	58.0	49.6	84	4		547	468	111.7	1.753	58.0	49.6	86
5		432	386	85.5	1.069	57.5	51.4	84	5		523	467	94.0	1.423	57.5	51.4	87
6		412	381	69.9	0.857	55.9	51.7	85	6		499	461	76.9	1.141	55.9	51.7	87
7		390	373	52.3	0.626	54.3	51.9	85	7		472	451	57.6	0.833	54.3	51.9	88
1	1200	618	396	187.0	4.171	46.1	29.6	95	1	1300	725	465	202.6	5.303	46.1	29.6	97
2		646	472	165.6	3.492	51.0	37.3	93	2		758	554	179.4	4.439	51.0	37.3	95
3		657	522	145.7	2.904	54.8	43.6	90	3		771	613	157.8	3.693	54.8	43.6	92
4		651	556	121.8	2.275	58.0	49.6	89	4		764	653	132.0	2.893	58.0	49.6	90
5		622	556	102.6	1.847	57.5	51.4	89	5		730	652	111.1	2.348	57.5	51.4	90
6		593	549	83.9	1.481	55.9	51.7	89	6		696	644	90.8	1.883	55.9	51.7	91
7		562	537	62.8	1.082	54.3	51.9	90	7		659	630	68.0	1.376	54.3	51.9	92
1	1400	841	539	218.1	6.623	46.1	29.6	99	1	1500	965	619	233.7	8.146	46.1	29.6	100
2		879	642	193.2	5.544	51.0	37.3	97	2		1009	737	207.0	6.819	51.0	37.3	98
3		894	711	169.9	4.612	54.8	43.6	94	3		1026	816	182.1	5.673	54.8	43.6	96
4		886	757	142.1	3.613	58.0	49.6	92	4		1017	869	152.3	4.444	58.0	49.6	94
5		847	756	119.6	2.933	57.5	51.4	92	5		972	868	128.2	3.607	57.5	51.4	94
6		808	747	97.8	2.352	55.9	51.7	93	6		927	857	104.8	2.892	55.9	51.7	94
7		765	731	73.3	1.718	54.3	51.9	93	7		878	839	78.5	2.113	54.3	51.9	95
1	1600	1098	704	249.3	9.887	46.1	29.6	102	1	1700	1240	795	264.9	11.859	46.1	29.6	103
2		1148	839	220.8	8.276	51.0	37.3	100	2		1296	947	234.6	9.927	51.0	37.3	101
3		1167	928	194.2	6.884	54.8	43.6	97	3		1318	1048	206.4	8.258	54.8	43.6	99
4		1157	989	162.4	5.394	58.0	49.6	95	4		1306	1117	172.6	6.469	58.0	49.6	97
5		1106	988	136.7	4.378	57.5	51.4	95	5		1249	1115	145.3	5.251	57.5	51.4	97
6		1055	975	111.8	3.510	55.9	51.7	96	6		1191	1101	118.8	4.211	55.9	51.7	97
7		999	954	83.7	2.565	54.3	51.9	97	7		1128	1077	89.0	3.076	54.3	51.9	98
1	1800	1390	891	280.5	14.077	46.1	29.6	105	1	1900	1549	993	296.0	16.556	46.1	29.6	106
2		1453	1062	248.4	11.784	51.0	37.3	103	2		1619	1183	262.2	13.859	51.0	37.3	104
3		1478	1175	218.5	9.802	54.8	43.6	100	3		1646	1309	230.6	11.528	54.8	43.6	101
4		1464	1252	182.7	7.680	58.0	49.6	98	4		1631	1395	192.9	9.032	58.0	49.6	100
5		1400	1250	153.8	6.233	57.5	51.4	98	5		1560	1393	162.4	7.331	57.5	51.4	100
6		1335	1235	125.8	4.998	55.9	51.7	99	6		1487	1376	132.8	5.878	55.9	51.7	100
7		1264	1208	94.2	3.652	54.3	51.9	99	7		1408	1345	99.4	4.295	54.3	51.9	101

- The A-weighted sound ratings shown have been calculated per AMCA International Standard 301.
- Values shown are for inlet LwiA sound power levels for installation type B - free inlet, ducted outlet.
- Performance certified is for installation type B - free inlet, ducted outlet.
- Performance ratings do not include the effects of appurtenances(accessories).
- Power rating (kW) does not include transmission losses.

Taeil Blower Co., LTD  
TSFD Series

TSFD-315

SIROCCO FAN  
FEG 67



Wheel dia. 315 mm Tip Speed = 0.0165 × rpm Outlet Dim. 404×404 Outlet Area 0.1632 m<sup>2</sup> Class 1 3638 rpm Class 2 4850 rpm Not Applicable

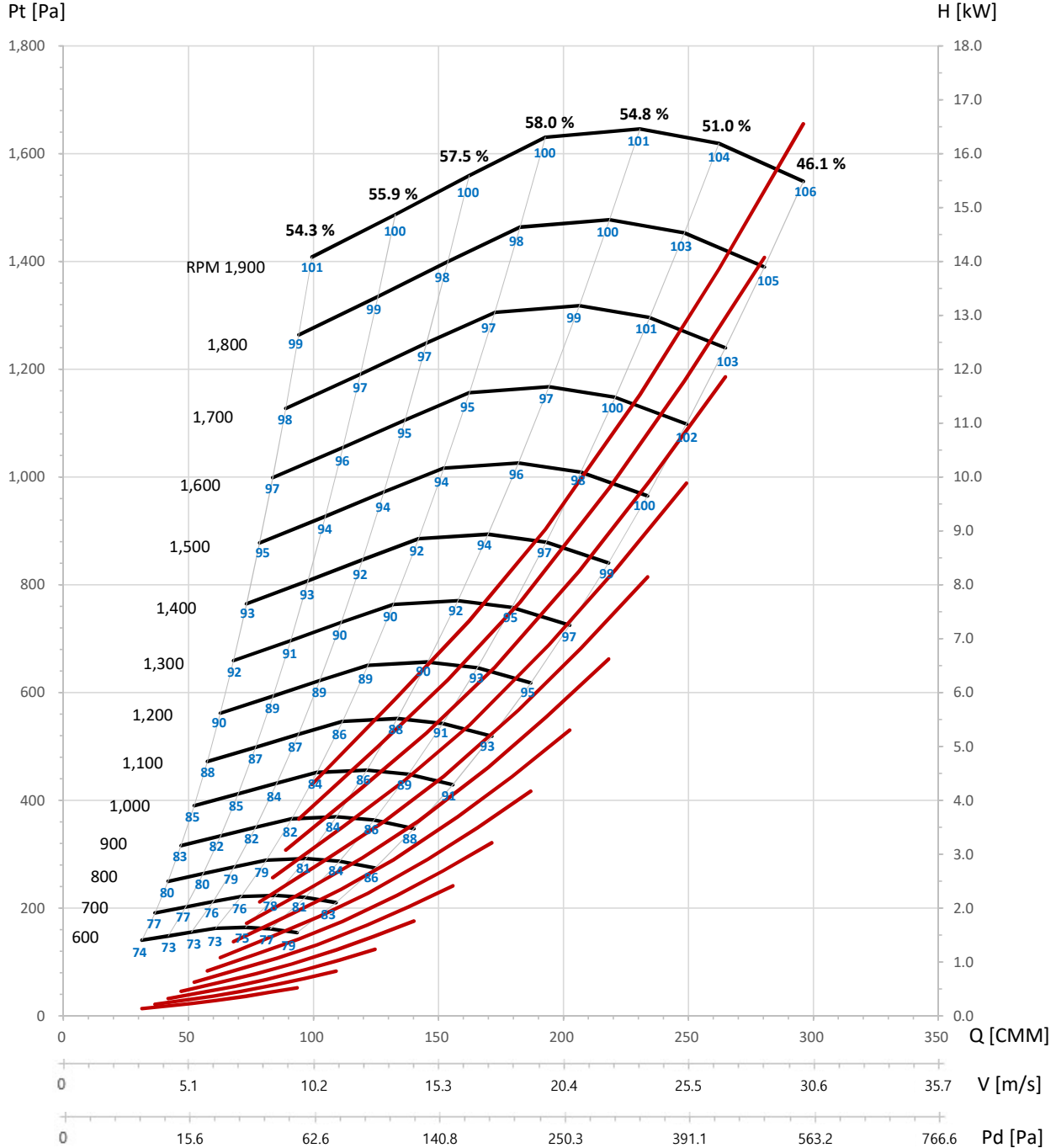

- The A-weighted sound ratings shown have been calculated per AMCA International Standard 301.
- Values shown are for inlet LwA sound power levels for installation type B - free inlet, ducted outlet.
- Performance certified is for installation type B - free inlet, ducted outlet.
- Performance ratings do not include the effects of appurtenances(accessories).
- Power rating (kW) does not include transmission losses.

Taeil Blower Co., LTD  
TSFD Series

TSFD-355

SIROCCO FAN  
FEG 67



Wheel dia. 355 mm | Tip Speed = 0.0186 × rpm | Outlet Dim. 453×453 | Outlet Area 0.2052 m<sup>2</sup> | Class 1 3228 rpm | Class 2 4304 rpm | Not Applicable

Det.	N	Pt	Ps	Q	H	EtaT	EtaS	Lwi	Det.	N	Pt	Ps	Q	H	EtaT	EtaS	Lwi
	[r/min]	[Pa]	[Pa]	[m <sup>3</sup> /min]	[kW]	[%]	[%]	[dB(A)]		[r/min]	[Pa]	[Pa]	[m <sup>3</sup> /min]	[kW]	[%]	[%]	[dB(A)]
1	600	197	127	135.1	0.963	46.1	29.6	83	1	700	269	172	157.6	1.529	46.1	29.6	86
2		206	151	119.7	0.806	51.0	37.3	81	2		281	205	139.6	1.280	51.0	37.3	84
3		210	167	105.3	0.671	54.8	43.6	79	3		286	227	122.8	1.065	54.8	43.6	82
4		208	178	88.0	0.525	58.0	49.6	77	4		283	242	102.7	0.834	58.0	49.6	80
5		199	178	74.1	0.426	57.5	51.4	77	5		271	242	86.5	0.677	57.5	51.4	80
6		190	175	60.6	0.342	55.9	51.7	77	6		258	239	70.7	0.543	55.9	51.7	80
7		180	172	45.4	0.250	54.3	51.9	78	7		244	233	52.9	0.397	54.3	51.9	81
1	800	351	225	180.1	2.283	46.1	29.6	89	1	900	444	285	202.6	3.250	46.1	29.6	92
2		367	268	159.6	1.911	51.0	37.3	87	2		464	339	179.5	2.721	51.0	37.3	90
3		373	297	140.3	1.590	54.8	43.6	85	3		472	375	157.9	2.263	54.8	43.6	88
4		370	316	117.4	1.245	58.0	49.6	83	4		468	400	132.0	1.773	58.0	49.6	86
5		353	316	98.8	1.011	57.5	51.4	83	5		447	399	111.2	1.439	57.5	51.4	86
6		337	312	80.8	0.811	55.9	51.7	83	6		427	395	90.9	1.154	55.9	51.7	86
7		319	305	60.5	0.592	54.3	51.9	84	7		404	386	68.1	0.843	54.3	51.9	87
1	1000	548	352	225.2	4.459	46.1	29.6	95	1	1100	664	425	247.7	5.934	46.1	29.6	97
2		573	419	199.5	3.732	51.0	37.3	92	2		694	507	219.4	4.968	51.0	37.3	95
3		583	463	175.4	3.105	54.8	43.6	90	3		705	561	193.0	4.132	54.8	43.6	92
4		577	494	146.7	2.432	58.0	49.6	88	4		699	598	161.4	3.237	58.0	49.6	90
5		552	493	123.5	1.974	57.5	51.4	88	5		668	597	135.9	2.628	57.5	51.4	90
6		527	487	101.0	1.583	55.9	51.7	88	6		637	589	111.1	2.107	55.9	51.7	91
7		499	476	75.6	1.157	54.3	51.9	89	7		603	576	83.2	1.539	54.3	51.9	91
1	1200	790	506	270.2	7.704	46.1	29.6	99	1	1300	927	594	292.7	9.795	46.1	29.6	101
2		825	603	239.3	6.449	51.0	37.3	97	2		969	708	259.3	8.200	51.0	37.3	98
3		839	667	210.5	5.365	54.8	43.6	94	3		985	783	228.0	6.821	54.8	43.6	96
4		832	711	176.0	4.203	58.0	49.6	92	4		976	835	190.7	5.344	58.0	49.6	94
5		795	710	148.2	3.411	57.5	51.4	92	5		933	833	160.6	4.337	57.5	51.4	94
6		758	701	121.2	2.735	55.9	51.7	93	6		890	823	131.3	3.478	55.9	51.7	95
7		718	686	90.7	1.998	54.3	51.9	93	7		843	805	98.3	2.541	54.3	51.9	95
1	1400	1075	689	315.2	12.234	46.1	29.6	102	1	1500	1234	791	337.7	15.047	46.1	29.6	104
2		1124	821	279.2	10.241	51.0	37.3	100	2		1290	942	299.2	12.596	51.0	37.3	102
3		1143	908	245.6	8.519	54.8	43.6	98	3		1312	1043	263.1	10.478	54.8	43.6	99
4		1132	968	205.4	6.674	58.0	49.6	96	4		1299	1111	220.0	8.209	58.0	49.6	98
5		1082	967	172.9	5.417	57.5	51.4	96	5		1243	1110	185.3	6.663	57.5	51.4	98
6		1032	955	141.4	4.344	55.9	51.7	96	6		1185	1096	151.5	5.343	55.9	51.7	98
7		977	934	105.9	3.174	54.3	51.9	97	7		1122	1072	113.4	3.903	54.3	51.9	99

- The A-weighted sound ratings shown have been calculated per AMCA International Standard 301.
- Values shown are for inlet LwiA sound power levels for installation type B - free inlet, ducted outlet.
- Performance certified is for installation type B - free inlet, ducted outlet.
- Performance ratings do not include the effects of appurtenances(accessories).
- Power rating (kW) does not include transmission losses.



Taeil Blower Co., LTD  
TSFD Series

TSFD-355

SIROCCO FAN  
FEG 67



Wheel dia. 355 mm Tip Speed = 0.0186 × rpm Outlet Dim. 453×453 Outlet Area 0.2052 m<sup>2</sup> Class 1 3228 rpm Class 2 4304 rpm Not Applicable

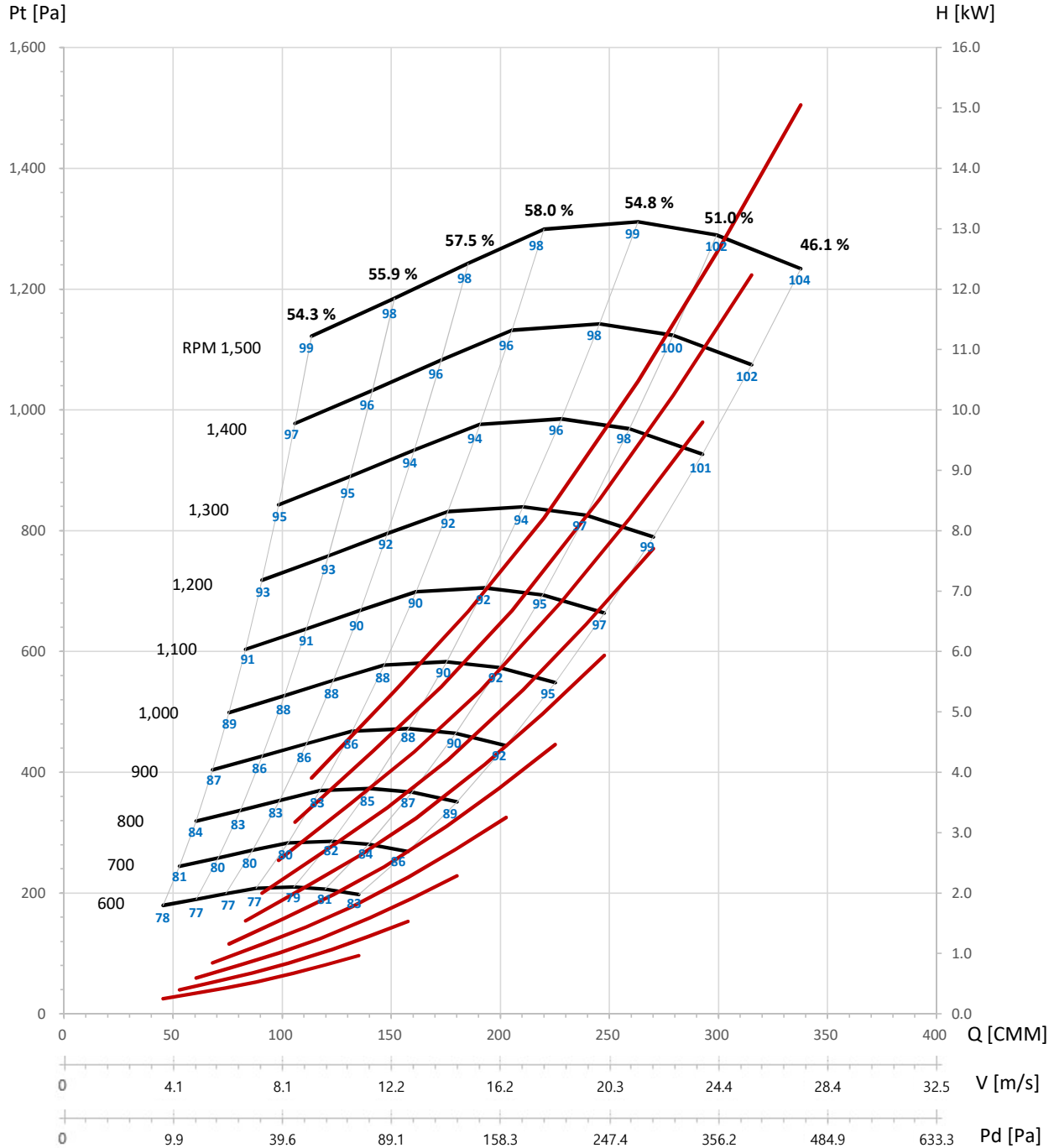

- The A-weighted sound ratings shown have been calculated per AMCA International Standard 301.
- Values shown are for inlet LwA sound power levels for installation type B - free inlet, ducted outlet.
- Performance certified is for installation type B - free inlet, ducted outlet.
- Performance ratings do not include the effects of appurtenances(accessories).
- Power rating (kW) does not include transmission losses.

Taeil Blower Co., LTD  
TSFD Series

TSFD-400

SIROCCO FAN  
FEG 63



Wheel dia. 400 mm    Tip Speed = 0.0209 × rpm    Outlet Dim. 507×507    Outlet Area 0.2570 m<sup>2</sup>    Class 1 2865 rpm    Class 2 3820 rpm    Not Applicable

Det.	N	Pt	Ps	Q	H	EtaT	EtaS	Lwi	Det.	N	Pt	Ps	Q	H	EtaT	EtaS	Lwi
	[r/min]	[Pa]	[Pa]	[m <sup>3</sup> /min]	[kW]	[%]	[%]	[dB(A)]		[r/min]	[Pa]	[Pa]	[m <sup>3</sup> /min]	[kW]	[%]	[%]	[dB(A)]
1	500	174	112	161.0	1.012	46.1	29.6	82	1	600	251	161	193.3	1.749	46.1	29.6	87
2		182	133	142.7	0.847	51.0	37.3	80	2		262	191	171.2	1.464	51.0	37.3	85
3		185	147	125.5	0.705	54.8	43.6	78	3		266	212	150.6	1.218	54.8	43.6	82
4		183	157	104.9	0.552	58.0	49.6	76	4		264	226	125.9	0.954	58.0	49.6	80
5		175	157	88.3	0.448	57.5	51.4	76	5		252	225	106.0	0.774	57.5	51.4	80
6		167	155	72.2	0.359	55.9	51.7	76	6		241	223	86.7	0.621	55.9	51.7	80
7		158	151	54.1	0.263	54.3	51.9	77	7		228	218	64.9	0.454	54.3	51.9	81
1	700	341	219	225.5	2.777	46.1	29.6	90	1	800	446	286	257.7	4.146	46.1	29.6	93
2		357	261	199.7	2.325	51.0	37.3	88	2		466	340	228.3	3.471	51.0	37.3	91
3		363	288	175.7	1.934	54.8	43.6	86	3		474	377	200.8	2.887	54.8	43.6	89
4		359	307	146.9	1.515	58.0	49.6	84	4		469	401	167.9	2.262	58.0	49.6	87
5		344	307	123.7	1.230	57.5	51.4	84	5		449	401	141.3	1.836	57.5	51.4	87
6		328	303	101.1	0.986	55.9	51.7	84	6		428	396	115.6	1.472	55.9	51.7	87
7		310	296	75.7	0.720	54.3	51.9	85	7		405	387	86.5	1.075	54.3	51.9	88
1	900	564	362	289.9	5.903	46.1	29.6	96	1	1000	696	446	322.1	8.097	46.1	29.6	98
2		590	431	256.8	4.941	51.0	37.3	94	2		728	532	285.3	6.778	51.0	37.3	96
3		599	477	225.9	4.110	54.8	43.6	91	3		740	588	250.9	5.638	54.8	43.6	94
4		594	508	188.9	3.220	58.0	49.6	89	4		733	627	209.8	4.417	58.0	49.6	92
5		568	507	159.0	2.614	57.5	51.4	89	5		701	626	176.7	3.585	57.5	51.4	92
6		542	501	130.0	2.096	55.9	51.7	90	6		669	618	144.5	2.875	55.9	51.7	92
7		513	490	97.3	1.531	54.3	51.9	90	7		633	605	108.2	2.100	54.3	51.9	93
1	1100	842	540	354.3	10.778	46.1	29.6	100	1	1200	1003	643	386.5	13.992	46.1	29.6	102
2		881	643	313.9	9.022	51.0	37.3	98	2		1048	766	342.4	11.713	51.0	37.3	100
3		895	712	276.0	7.505	54.8	43.6	96	3		1066	847	301.1	9.743	54.8	43.6	98
4		887	759	230.8	5.880	58.0	49.6	94	4		1056	903	251.8	7.633	58.0	49.6	96
5		848	758	194.3	4.772	57.5	51.4	94	5		1010	902	212.0	6.195	57.5	51.4	96
6		809	748	158.9	3.827	55.9	51.7	94	6		963	890	173.4	4.968	55.9	51.7	96
7		766	732	119.0	2.796	54.3	51.9	95	7		912	871	129.8	3.630	54.3	51.9	97
1	1300	1177	754	418.7	17.790	46.1	29.6	104	1	1400	1365	875	450.9	22.219	46.1	29.6	106
2		1230	899	370.9	14.892	51.0	37.3	102	2		1426	1042	399.4	18.600	51.0	37.3	104
3		1251	994	326.2	12.388	54.8	43.6	100	3		1451	1153	351.3	15.472	54.8	43.6	101
4		1239	1060	272.8	9.705	58.0	49.6	98	4		1437	1229	293.8	12.121	58.0	49.6	100
5		1185	1058	229.7	7.877	57.5	51.4	98	5		1374	1227	247.3	9.838	57.5	51.4	100
6		1130	1045	187.8	6.316	55.9	51.7	98	6		1310	1212	202.2	7.889	55.9	51.7	100
7		1070	1022	140.6	4.615	54.3	51.9	99	7		1241	1185	151.4	5.764	54.3	51.9	101

- The A-weighted sound ratings shown have been calculated per AMCA International Standard 301.
- Values shown are for inlet LwiA sound power levels for installation type B - free inlet, ducted outlet.
- Performance certified is for installation type B - free inlet, ducted outlet.
- Performance ratings do not include the effects of appurtenances(accessories).
- Power rating (kW) does not include transmission losses.

Taeil Blower Co., LTD  
TSFD Series

TSFD-400

SIROCCO FAN  
FEG 63



Wheel dia. 400 mm | Tip Speed = 0.0209 × rpm | Outlet Dim. 507×507 | Outlet Area 0.2570 m<sup>2</sup> | Class 1 2865 rpm | Class 2 3820 rpm | Not Applicable

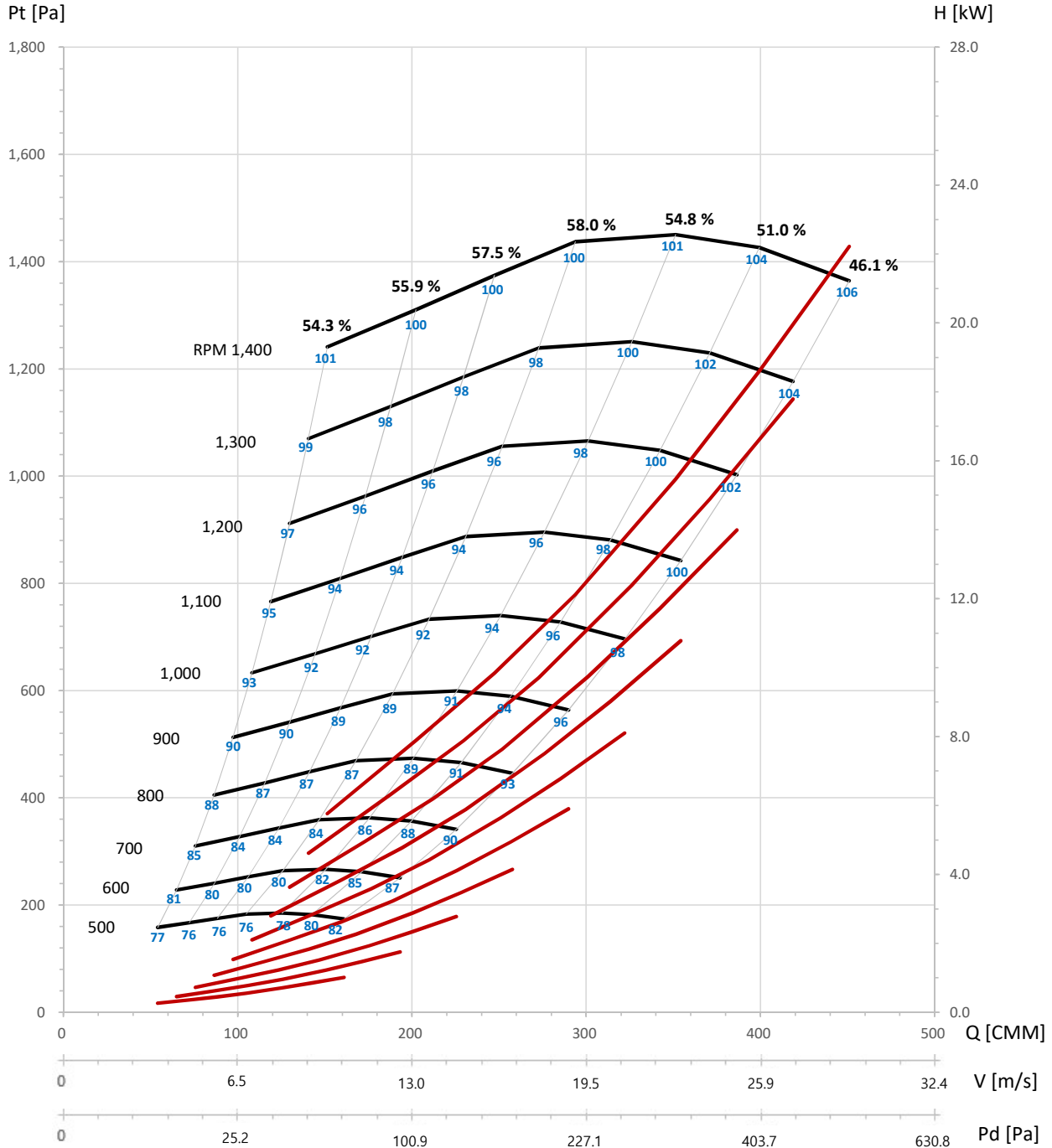

- The A-weighted sound ratings shown have been calculated per AMCA International Standard 301.
- Values shown are for inlet LwA sound power levels for installation type B - free inlet, ducted outlet.
- Performance certified is for installation type B - free inlet, ducted outlet.
- Performance ratings do not include the effects of appurtenances(accessories).
- Power rating (kW) does not include transmission losses.

Taeil Blower Co., LTD  
TSFD Series

TSFD-450

SIROCCO FAN  
FEG 67



Wheel dia. 450 mm | Tip Speed = 0.0236 × rpm | Outlet Dim. 569×569 | Outlet Area 0.3238 m<sup>2</sup> | Class 1 2546 rpm | Class 2 3395 rpm | Not Applicable

Det.	N [r/min]	Pt	Ps	Q	H	EtaT	EtaS	Lwi	Det.	N [r/min]	Pt	Ps	Q	H	EtaT	EtaS	Lwi
		[Pa]	[Pa]	[m <sup>3</sup> /min]	[kW]	[%]	[%]	[dB(A)]			[Pa]	[Pa]	[m <sup>3</sup> /min]	[kW]	[%]	[%]	[dB(A)]
1	500	162	59	255.1	1.857	37.1	13.6	90	1	600	233	85	306.1	3.209	37.1	13.6	94
2		184	104	225.1	1.546	44.6	25.3	86	2		265	150	270.1	2.671	44.6	25.3	90
3		198	136	197.8	1.277	51.0	35.1	83	3		285	196	237.4	2.206	51.0	35.1	88
4		207	163	168.6	1.021	57.0	44.7	80	4		299	234	202.3	1.765	57.0	44.7	84
5		216	185	140.6	0.824	61.3	52.5	78	5		311	266	168.8	1.424	61.3	52.5	82
6		212	193	110.8	0.638	61.2	55.7	76	6		305	277	133.0	1.103	61.2	55.7	80
7		203	190	90.9	0.520	59.1	55.3	77	7		293	274	109.0	0.899	59.1	55.3	81
1	700	318	116	357.1	5.096	37.1	13.6	97	1	800	415	152	408.1	7.607	37.1	13.6	100
2		361	204	315.1	4.241	44.6	25.3	94	2		471	267	360.1	6.331	44.6	25.3	97
3		387	266	277.0	3.503	51.0	35.1	91	3		506	348	316.5	5.229	51.0	35.1	94
4		406	319	236.0	2.802	57.0	44.7	88	4		531	416	269.7	4.183	57.0	44.7	91
5		423	362	196.9	2.261	61.3	52.5	86	5		553	473	225.0	3.375	61.3	52.5	89
6		415	377	155.1	1.751	61.2	55.7	84	6		542	493	177.3	2.614	61.2	55.7	87
7		398	373	127.2	1.427	59.1	55.3	85	7		520	487	145.4	2.130	59.1	55.3	88
1	900	525	192	459.1	10.831	37.1	13.6	103	1	1000	648	237	510.1	14.857	37.1	13.6	106
2		596	337	405.1	9.014	44.6	25.3	100	2		736	416	450.1	12.364	44.6	25.3	102
3		640	440	356.1	7.445	51.0	35.1	97	3		791	544	395.7	10.213	51.0	35.1	100
4		672	527	303.4	5.955	57.0	44.7	94	4		829	650	337.1	8.169	57.0	44.7	97
5		700	599	253.1	4.805	61.3	52.5	92	5		864	739	281.3	6.592	61.3	52.5	94
6		687	624	199.4	3.722	61.2	55.7	90	6		848	770	221.6	5.105	61.2	55.7	93
7		658	616	163.6	3.033	59.1	55.3	91	7		813	761	181.7	4.160	59.1	55.3	93
1	1100	784	287	561.1	19.775	37.1	13.6	108	1	1200	933	342	612.1	25.673	37.1	13.6	110
2		891	504	495.1	16.457	44.6	25.3	105	2		1060	600	540.1	21.366	44.6	25.3	107
3		957	658	435.2	13.593	51.0	35.1	102	3		1138	783	474.8	17.648	51.0	35.1	104
4		1004	787	370.8	10.873	57.0	44.7	99	4		1194	937	404.6	14.116	57.0	44.7	101
5		1045	894	309.4	8.774	61.3	52.5	97	5		1244	1064	337.5	11.391	61.3	52.5	99
6		1026	932	243.8	6.795	61.2	55.7	95	6		1221	1109	265.9	8.821	61.2	55.7	98
7		983	920	199.9	5.537	59.1	55.3	96	7		1170	1095	218.1	7.189	59.1	55.3	98
1	1300	1096	401	663.1	32.641	37.1	13.6	112	1	1400	1271	465	714.2	40.768	37.1	13.6	114
2		1244	704	585.1	27.165	44.6	25.3	109	2		1443	816	630.2	33.928	44.6	25.3	110
3		1336	919	514.4	22.438	51.0	35.1	106	3		1549	1066	553.9	28.024	51.0	35.1	108
4		1402	1099	438.3	17.948	57.0	44.7	103	4		1626	1275	472.0	22.416	57.0	44.7	105
5		1459	1249	365.6	14.482	61.3	52.5	101	5		1693	1449	393.8	18.088	61.3	52.5	103
6		1432	1302	288.1	11.216	61.2	55.7	100	6		1661	1510	310.2	14.008	61.2	55.7	101
7		1374	1286	236.2	9.140	59.1	55.3	100	7		1593	1491	254.4	11.416	59.1	55.3	102

- The A-weighted sound ratings shown have been calculated per AMCA International Standard 301.
- Values shown are for inlet LwiA sound power levels for installation type B - free inlet, ducted outlet.
- Performance certified is for installation type B - free inlet, ducted outlet.
- Performance ratings do not include the effects of appurtenances(accessories).
- Power rating (kW) does not include transmission losses.

Taeil Blower Co., LTD  
TSFD Series

TSFD-450

SIROCCO FAN  
FEG 67



Wheel dia. 450 mm Tip Speed = 0.0236 × rpm Outlet Dim. 569×569 Outlet Area 0.3238 m<sup>2</sup> Class 1 2546 rpm Class 2 3395 rpm Not Applicable

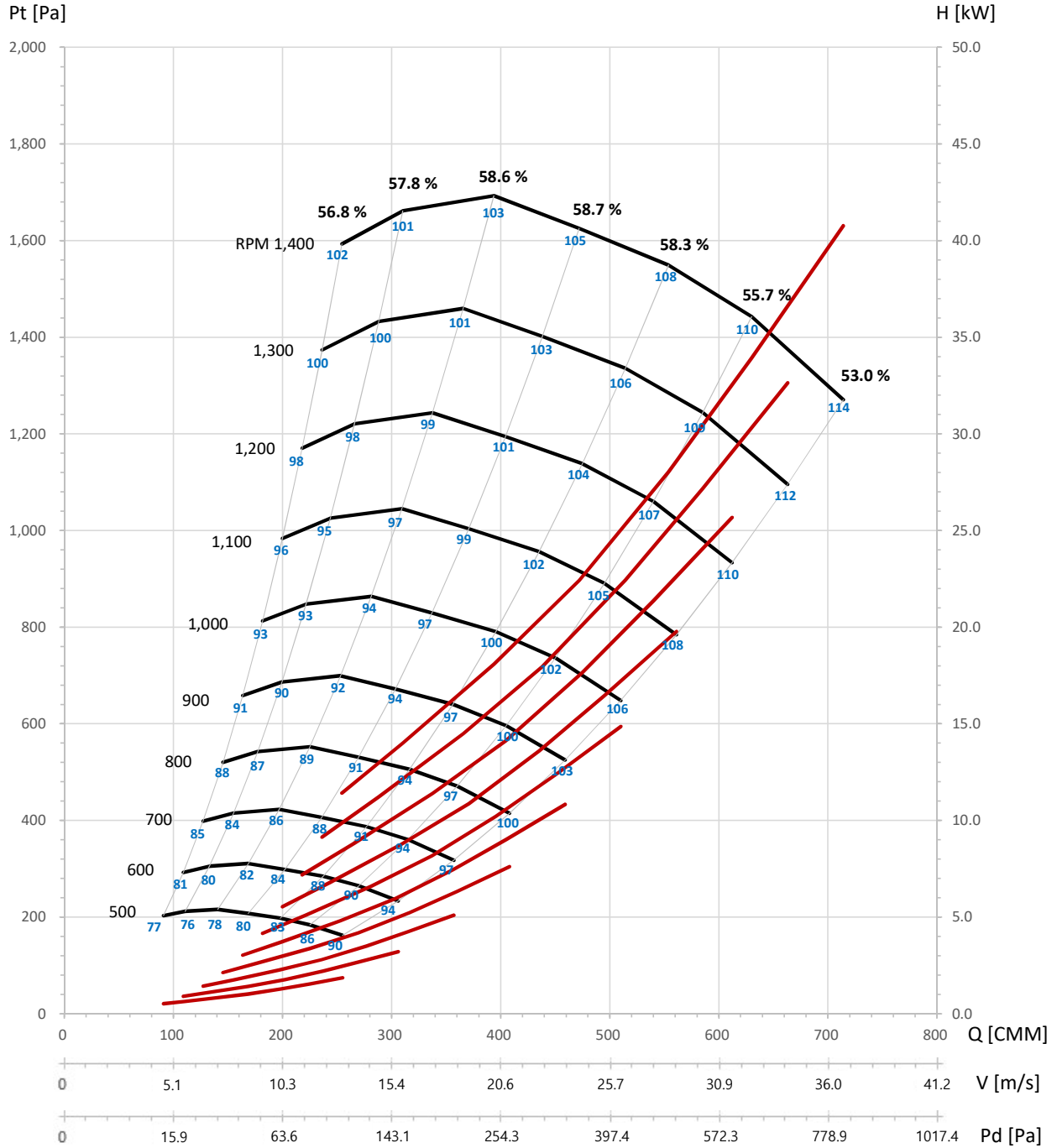

- The A-weighted sound ratings shown have been calculated per AMCA International Standard 301.
- Values shown are for inlet LwA sound power levels for installation type B - free inlet, ducted outlet.
- Performance certified is for installation type B - free inlet, ducted outlet.
- Performance ratings do not include the effects of appurtenances(accessories).
- Power rating (kW) does not include transmission losses.

**Taeil Blower Co., LTD**  
**TSFD Series**

**TSFD-500**

**SIROCCO FAN**  
**FEG 67**



Wheel dia. 500 mm | Tip Speed = 0.0262 × rpm | Outlet Dim. 638×638 | Outlet Area 0.4070 m<sup>2</sup> | Class 1 2292 rpm | Class 2 3056 rpm | Not Applicable

Det.	N	Pt	Ps	Q	H	EtaT	EtaS	Lwi	Det.	N	Pt	Ps	Q	H	EtaT	EtaS	Lwi
	[r/min]	[Pa]	[Pa]	[m <sup>3</sup> /min]	[kW]	[%]	[%]	[dB(A)]		[r/min]	[Pa]	[Pa]	[m <sup>3</sup> /min]	[kW]	[%]	[%]	[dB(A)]
1	400	128	47	279.9	1.610	37.1	13.6	88	1	500	200	73	349.9	3.145	37.1	13.6	93
2		145	82	247.0	1.340	44.6	25.3	84	2		227	129	308.7	2.617	44.6	25.3	89
3		156	107	217.1	1.107	51.0	35.1	81	3		244	168	271.4	2.162	51.0	35.1	86
4		164	128	185.0	0.885	57.0	44.7	78	4		256	201	231.2	1.729	57.0	44.7	83
5		171	146	154.3	0.714	61.3	52.5	76	5		267	228	192.9	1.395	61.3	52.5	81
6		167	152	121.6	0.553	61.2	55.7	74	6		262	238	152.0	1.081	61.2	55.7	79
7		161	150	99.7	0.451	59.1	55.3	75	7		251	235	124.6	0.881	59.1	55.3	80
1	600	288	105	419.8	5.435	37.1	13.6	97	1	700	392	144	489.8	8.630	37.1	13.6	101
2		327	185	370.5	4.523	44.6	25.3	93	2		445	252	432.2	7.182	44.6	25.3	97
3		351	242	325.6	3.736	51.0	35.1	91	3		478	329	379.9	5.932	51.0	35.1	94
4		369	289	277.5	2.988	57.0	44.7	88	4		502	393	323.7	4.745	57.0	44.7	91
5		384	328	231.5	2.411	61.3	52.5	85	5		522	447	270.1	3.829	61.3	52.5	89
6		377	342	182.4	1.867	61.2	55.7	84	6		513	466	212.8	2.965	61.2	55.7	87
7		361	338	149.6	1.522	59.1	55.3	84	7		492	460	174.5	2.417	59.1	55.3	88
1	800	512	188	559.8	12.882	37.1	13.6	104	1	900	648	237	629.8	18.342	37.1	13.6	106
2		582	329	494.0	10.721	44.6	25.3	100	2		736	416	555.7	15.265	44.6	25.3	103
3		625	430	434.2	8.855	51.0	35.1	98	3		791	544	488.5	12.608	51.0	35.1	100
4		655	514	370.0	7.083	57.0	44.7	94	4		829	650	416.2	10.085	57.0	44.7	97
5		682	584	308.6	5.716	61.3	52.5	92	5		864	739	347.2	8.138	61.3	52.5	95
6		670	609	243.2	4.426	61.2	55.7	91	6		848	770	273.6	6.302	61.2	55.7	93
7		642	601	199.4	3.607	59.1	55.3	91	7		813	761	224.4	5.136	59.1	55.3	94
1	1000	800	293	699.7	25.161	37.1	13.6	109	1	1100	968	355	769.7	33.489	37.1	13.6	111
2		909	514	617.4	20.939	44.6	25.3	105	2		1100	622	679.2	27.870	44.6	25.3	108
3		976	671	542.7	17.296	51.0	35.1	103	3		1181	812	597.0	23.020	51.0	35.1	105
4		1024	803	462.5	13.834	57.0	44.7	100	4		1239	972	508.7	18.414	57.0	44.7	102
5		1066	912	385.8	11.163	61.3	52.5	98	5		1290	1104	424.4	14.858	61.3	52.5	100
6		1046	951	304.0	8.645	61.2	55.7	96	6		1266	1151	334.4	11.507	61.2	55.7	99
7		1003	939	249.3	7.046	59.1	55.3	97	7		1214	1136	274.2	9.378	59.1	55.3	99

- The A-weighted sound ratings shown have been calculated per AMCA International Standard 301.
- Values shown are for inlet LwiA sound power levels for installation type B - free inlet, ducted outlet.
- Performance certified is for installation type B - free inlet, ducted outlet.
- Performance ratings do not include the effects of appurtenances(accessories).
- Power rating (kW) does not include transmission losses.

Taeil Blower Co., LTD  
TSFD Series

TSFD-500

SIROCCO FAN  
FEG 67



Wheel dia. 500 mm Tip Speed = 0.0262 × rpm Outlet Dim. 638×638 Outlet Area 0.4070 m<sup>2</sup> Class 1 2292 rpm Class 2 3056 rpm Not Applicable

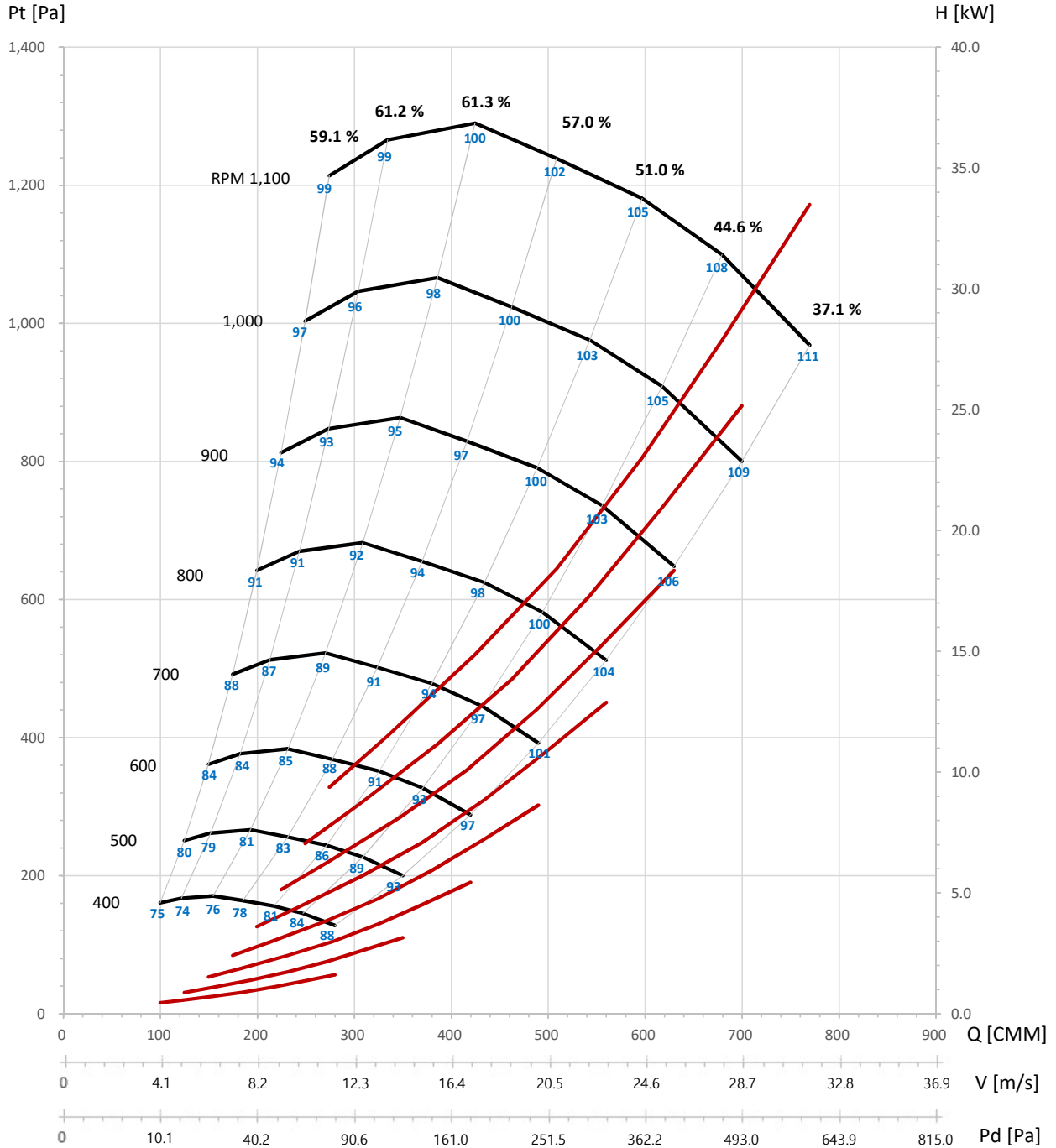

- The A-weighted sound ratings shown have been calculated per AMCA International Standard 301.
- Values shown are for inlet LwA sound power levels for installation type B - free inlet, ducted outlet.
- Performance certified is for installation type B - free inlet, ducted outlet.
- Performance ratings do not include the effects of appurtenances(accessories).
- Power rating (kW) does not include transmission losses.

Taeil Blower Co., LTD  
TSFD Series

TSFD-560

SIROCCO FAN  
FEG 63



Wheel dia. 560 mm    Tip Speed = 0.0293 × rpm    Outlet Dim. 715×715    Outlet Area 0.5112 m<sup>2</sup>    Class 1 2046 rpm    Class 2 2728 rpm    Not Applicable

Det.	300							400								
	N [r/min]	Pt [Pa]	Ps [Pa]	Q [m <sup>3</sup> /min]	H [kW]	EtaT [%]	EtaS [%]	Lwi [dB(A)]	Det.	N [r/min]	Pt [Pa]	Ps [Pa]	Q [m <sup>3</sup> /min]	H [kW]	EtaT [%]	EtaS [%]
1	91	33	296.5	1.208	37.1	13.6	84	1	161	59	395.3	2.863	37.1	13.6	91	
2	103	58	261.6	1.005	44.6	25.3	81	2	183	104	348.8	2.383	44.6	25.3	87	
3	111	76	230.0	0.830	51.0	35.1	78	3	197	135	306.6	1.968	51.0	35.1	85	
4	116	91	196.0	0.664	57.0	44.7	75	4	206	162	261.3	1.574	57.0	44.7	82	
5	121	103	163.5	0.536	61.3	52.5	73	5	215	184	218.0	1.270	61.3	52.5	80	
6	119	108	128.8	0.415	61.2	55.7	71	6	211	192	171.7	0.984	61.2	55.7	78	
7	114	106	105.6	0.338	59.1	55.3	72	7	202	189	140.8	0.802	59.1	55.3	78	
1	252	92	494.2	5.592	37.1	13.6	96	1	363	133	593.0	9.664	37.1	13.6	100	
2	286	162	436.1	4.654	44.6	25.3	93	2	412	233	523.3	8.042	44.6	25.3	97	
3	307	211	383.3	3.844	51.0	35.1	90	3	442	304	460.0	6.643	51.0	35.1	94	
4	322	253	326.6	3.075	57.0	44.7	87	4	464	364	391.9	5.313	57.0	44.7	91	
5	336	287	272.5	2.481	61.3	52.5	85	5	483	414	327.0	4.288	61.3	52.5	89	
6	329	299	214.7	1.922	61.2	55.7	83	6	474	431	257.6	3.320	61.2	55.7	87	
7	316	296	176.1	1.566	59.1	55.3	84	7	455	426	211.3	2.706	59.1	55.3	88	
1	494	181	691.9	15.346	37.1	13.6	104	1	645	236	790.7	22.906	37.1	13.6	107	
2	561	317	610.5	12.771	44.6	25.3	100	2	732	414	697.7	19.063	44.6	25.3	104	
3	602	414	536.6	10.549	51.0	35.1	98	3	786	541	613.3	15.746	51.0	35.1	101	
4	632	495	457.2	8.438	57.0	44.7	95	4	825	647	522.6	12.595	57.0	44.7	98	
5	658	563	381.5	6.809	61.3	52.5	92	5	859	735	436.0	10.163	61.3	52.5	96	
6	645	587	300.6	5.273	61.2	55.7	91	6	843	766	343.5	7.871	61.2	55.7	94	
7	619	579	246.5	4.297	59.1	55.3	91	7	808	757	281.7	6.414	59.1	55.3	95	
1	816	299	889.5	32.615	37.1	13.6	110	1	1007	369	988.4	44.739	37.1	13.6	112	
2	927	524	784.9	27.143	44.6	25.3	106	2	1144	647	872.1	37.233	44.6	25.3	109	
3	995	685	689.9	22.419	51.0	35.1	104	3	1229	845	766.6	30.754	51.0	35.1	107	
4	1044	819	587.9	17.933	57.0	44.7	101	4	1289	1011	653.2	24.599	57.0	44.7	103	
5	1087	930	490.5	14.471	61.3	52.5	98	5	1342	1149	544.9	19.850	61.3	52.5	101	
6	1067	970	386.4	11.207	61.2	55.7	97	6	1317	1197	429.4	15.372	61.2	55.7	100	
7	1023	958	316.9	9.133	59.1	55.3	98	7	1263	1182	352.1	12.528	59.1	55.3	100	

- The A-weighted sound ratings shown have been calculated per AMCA International Standard 301.
- Values shown are for inlet LwiA sound power levels for installation type B - free inlet, ducted outlet.
- Performance certified is for installation type B - free inlet, ducted outlet.
- Performance ratings do not include the effects of appurtenances(accessories).
- Power rating (kW) does not include transmission losses.



Taeil Blower Co., LTD  
TSFD Series

TSFD-560

SIROCCO FAN  
FEG 63



Wheel dia. 560 mm Tip Speed = 0.0293 × rpm Outlet Dim. 715×715 Outlet Area 0.5112 m<sup>2</sup> Class 1 2046 rpm Class 2 2728 rpm Not Applicable

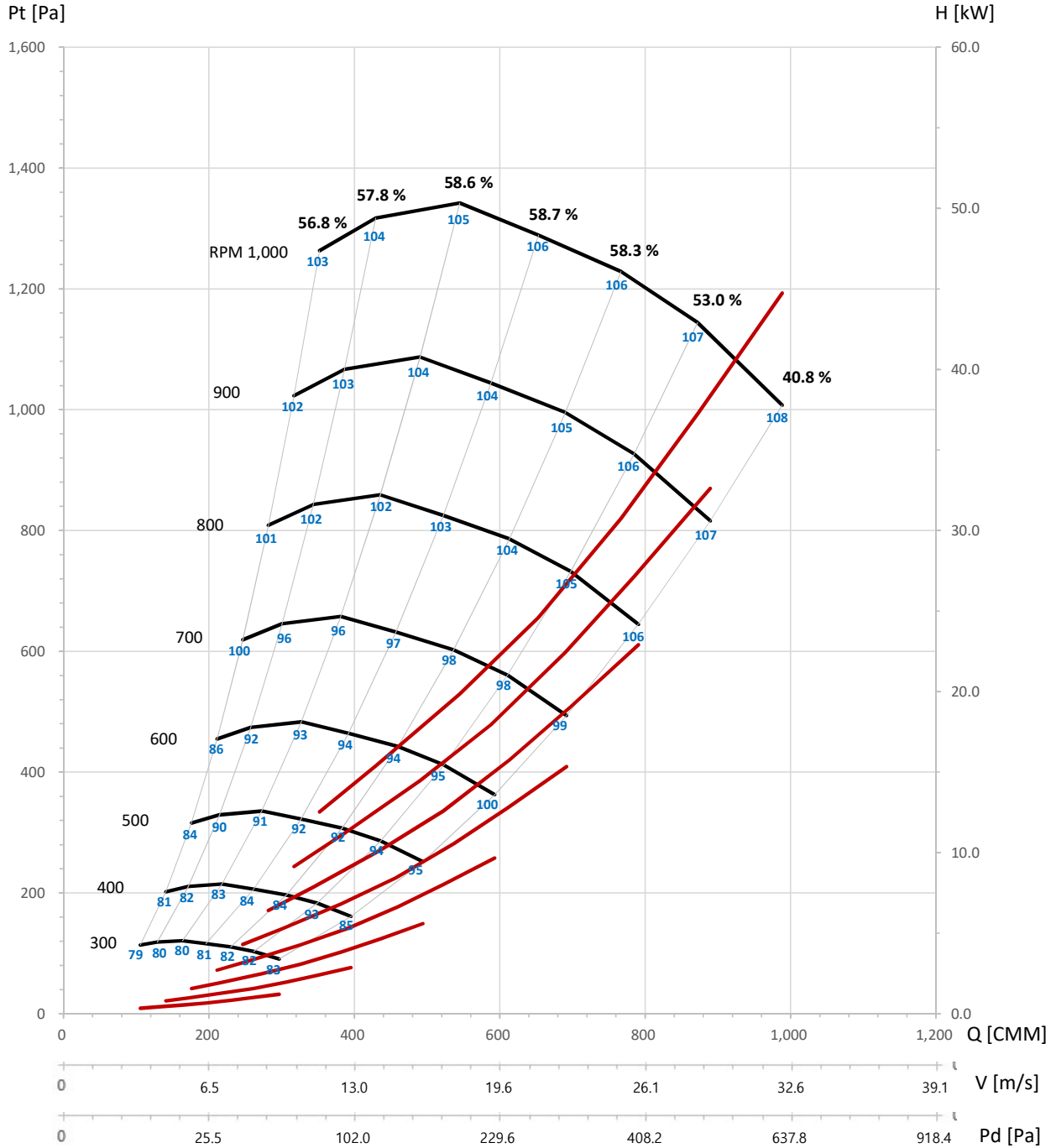

- The A-weighted sound ratings shown have been calculated per AMCA International Standard 301.
- Values shown are for inlet LwiA sound power levels for installation type B - free inlet, ducted outlet.
- Performance certified is for installation type B - free inlet, ducted outlet.
- Performance ratings do not include the effects of appurtenances(accessories).
- Power rating (kW) does not include transmission losses.

Taeil Blower Co., LTD  
TSFD Series

TSFD-630

SIROCCO FAN  
FEG 63



Wheel dia. 630 mm Tip Speed = 0.033 × rpm Outlet Dim. 801×801 Outlet Area 0.6416 m<sup>2</sup> Class 1 1819 rpm Class 2 2425 rpm Not Applicable

Det.	N [r/min]	Pt	Ps	Q	H	EtaT	EtaS	Lwi	Det.	N [r/min]	Pt	Ps	Q	H	EtaT	EtaS	Lwi
		[Pa]	[Pa]	[m <sup>3</sup> /min]	[kW]	[%]	[%]	[dB(A)]			[Pa]	[Pa]	[m <sup>3</sup> /min]	[kW]	[%]	[%]	[dB(A)]
1	300	114	42	419.9	2.157	37.1	13.6	88	1	400	203	74	559.9	5.114	37.1	13.6	95
2		130	73	370.5	1.795	44.6	25.3	84	2		231	131	494.0	4.256	44.6	25.3	91
3		139	96	325.7	1.483	51.0	35.1	81	3		248	171	434.3	3.515	51.0	35.1	88
4		146	115	277.5	1.186	57.0	44.7	79	4		260	204	370.0	2.812	57.0	44.7	85
5		152	130	231.5	0.957	61.3	52.5	76	5		271	232	308.7	2.269	61.3	52.5	83
6		150	136	182.4	0.741	61.2	55.7	74	6		266	242	243.2	1.757	61.2	55.7	81
7		143	134	149.6	0.604	59.1	55.3	75	7		255	239	199.5	1.432	59.1	55.3	82
1	500	318	116	699.9	9.988	37.1	13.6	100	1	600	457	167	839.9	17.260	37.1	13.6	104
2		361	204	617.6	8.312	44.6	25.3	96	2		519	294	741.1	14.364	44.6	25.3	100
3		387	266	542.8	6.866	51.0	35.1	93	3		558	384	651.4	11.864	51.0	35.1	98
4		406	319	462.5	5.492	57.0	44.7	90	4		585	459	555.0	9.490	57.0	44.7	95
5		423	362	385.9	4.432	61.3	52.5	88	5		609	522	463.1	7.658	61.3	52.5	92
6		415	377	304.0	3.432	61.2	55.7	86	6		598	544	364.8	5.930	61.2	55.7	91
7		398	373	249.3	2.797	59.1	55.3	87	7		573	537	299.2	4.833	59.1	55.3	91
1	700	623	228	979.8	27.408	37.1	13.6	108	1	800	813	298	1119.8	40.912	37.1	13.6	111
2		707	400	864.6	22.809	44.6	25.3	104	2		923	522	988.1	34.047	44.6	25.3	107
3		759	522	760.0	18.840	51.0	35.1	101	3		992	682	868.5	28.123	51.0	35.1	105
4		797	625	647.6	15.070	57.0	44.7	98	4		1040	816	740.1	22.495	57.0	44.7	101
5		829	710	540.2	12.160	61.3	52.5	96	5		1083	927	617.4	18.152	61.3	52.5	99
6		814	740	425.6	9.417	61.2	55.7	94	6		1063	966	486.5	14.057	61.2	55.7	98
7		781	731	349.1	7.675	59.1	55.3	95	7		1020	954	398.9	11.456	59.1	55.3	98
1	900	1029	377	1259.8	58.251	37.1	13.6	113	1	1000	1271	465	1399.8	79.905	37.1	13.6	116
2		1169	661	1111.6	48.478	44.6	25.3	110	2		1443	816	1235.1	66.499	44.6	25.3	112
3		1255	863	977.1	40.042	51.0	35.1	107	3		1549	1066	1085.7	54.927	51.0	35.1	110
4		1317	1033	832.6	32.029	57.0	44.7	104	4		1626	1275	925.1	43.935	57.0	44.7	107
5		1371	1173	694.6	25.845	61.3	52.5	102	5		1693	1449	771.8	35.452	61.3	52.5	105
6		1346	1223	547.3	20.015	61.2	55.7	101	6		1661	1510	608.1	27.456	61.2	55.7	103
7		1290	1208	448.8	16.312	59.1	55.3	101	7		1593	1491	498.7	22.375	59.1	55.3	104

- The A-weighted sound ratings shown have been calculated per AMCA International Standard 301.
- Values shown are for inlet LwiA sound power levels for installation type B - free inlet, ducted outlet.
- Performance certified is for installation type B - free inlet, ducted outlet.
- Performance ratings do not include the effects of appurtenances(accessories).
- Power rating (kW) does not include transmission losses.

Taeil Blower Co., LTD  
TSFD Series

TSFD-630

SIROCCO FAN  
FEG 63



Wheel dia. 630 mm Tip Speed = 0.033 x rpm Outlet Dim. 801x801 Outlet Area 0.6416 m<sup>2</sup> Class 1 1819 rpm Class 2 2425 rpm Not Applicable

Pt [Pa]

H [kW]

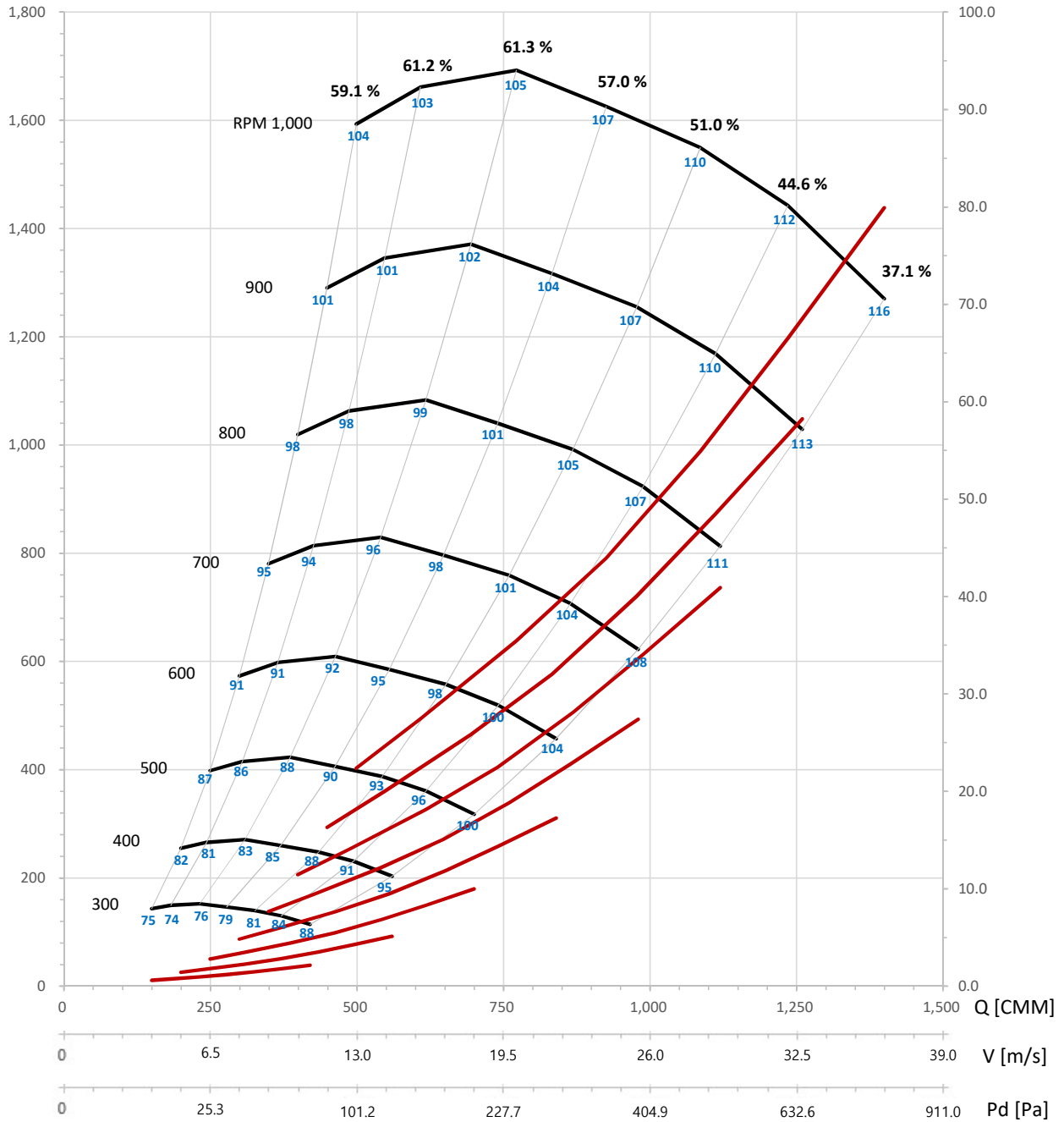

- The A-weighted sound ratings shown have been calculated per AMCA International Standard 301.
- Values shown are for inlet LwA sound power levels for installation type B - free inlet, ducted outlet.
- Performance certified is for installation type B - free inlet, ducted outlet.
- Performance ratings do not include the effects of appurtenances(accessories).
- Power rating (kW) does not include transmission losses.

Taeil Blower Co., LTD  
TSFD Series

TSFD-710

SIROCCO FAN  
FEG 67



Wheel dia. 710 mm | Tip Speed = 0.0372 × rpm | Outlet Dim. 898×898 | Outlet Area 0.8064 m<sup>2</sup> | Class 1 1614 rpm | Class 2 2152 rpm | Not Applicable

Det.									Det.								
	N [r/min]	Pt [Pa]	Ps [Pa]	Q [m <sup>3</sup> /min]	H [kW]	EtaT [%]	EtaS [%]	Lwi [dB(A)]		N [r/min]	Pt [Pa]	Ps [Pa]	Q [m <sup>3</sup> /min]	H [kW]	EtaT [%]	EtaS [%]	Lwi [dB(A)]
1	300	152	56	607.3	4.205	36.6	13.5	94	1	350	207	76	708.5	6.678	36.6	13.5	98
2		173	99	533.3	3.415	45.0	25.8	88	2		235	135	622.1	5.422	45.0	25.8	92
3		185	129	464.9	2.759	51.9	36.1	84	3		252	175	542.4	4.381	51.9	36.1	88
4		192	152	395.2	2.181	58.0	45.8	81	4		262	207	461.0	3.463	58.0	45.8	85
5		195	165	340.1	1.787	61.7	52.2	79	5		265	225	396.8	2.838	61.7	52.2	83
6		192	170	292.0	1.475	63.3	56.1	78	6		262	232	340.7	2.342	63.3	56.1	81
7		184	171	230.7	1.126	62.8	58.1	78	7		251	232	269.1	1.788	62.8	58.1	81
8		164	156	175.9	0.878	54.6	51.9	81	8		223	212	205.3	1.394	54.6	51.9	84
1	400	270	100	809.7	9.968	36.6	13.5	101	1	450	342	126	911.0	14.193	36.6	13.5	104
2		307	176	711.0	8.094	45.0	25.8	95	2		389	223	799.9	11.525	45.0	25.8	98
3		329	229	619.8	6.539	51.9	36.1	91	3		416	290	697.3	9.311	51.9	36.1	94
4		342	270	526.9	5.170	58.0	45.8	88	4		433	342	592.8	7.361	58.0	45.8	91
5		347	293	453.5	4.236	61.7	52.2	86	5		439	371	510.2	6.032	61.7	52.2	89
6		342	303	389.3	3.496	63.3	56.1	85	6		433	383	438.0	4.978	63.3	56.1	87
7		328	303	307.5	2.669	62.8	58.1	85	7		415	384	346.0	3.800	62.8	58.1	87
8		291	277	234.6	2.081	54.6	51.9	88	8		368	350	263.9	2.963	54.6	51.9	90
1	500	423	156	1012.2	19.469	36.6	13.5	106	1	550	511	189	1113.4	25.913	36.6	13.5	109
2		480	275	888.8	15.809	45.0	25.8	101	2		581	333	977.6	21.042	45.0	25.8	103
3		514	358	774.8	12.772	51.9	36.1	97	3		621	433	852.3	17.000	51.9	36.1	99
4		535	422	658.6	10.097	58.0	45.8	94	4		647	511	724.5	13.439	58.0	45.8	96
5		542	458	566.9	8.274	61.7	52.2	91	5		655	555	623.6	11.013	61.7	52.2	94
6		534	473	486.7	6.829	63.3	56.1	90	6		646	572	535.3	9.089	63.3	56.1	92
7		512	474	384.4	5.212	62.8	58.1	90	7		619	573	422.9	6.937	62.8	58.1	92
8		455	432	293.2	4.064	54.6	51.9	93	8		550	523	322.6	5.409	54.6	51.9	95
1	600	608	225	1214.6	33.642	36.6	13.5	111	1	650	714	264	1315.8	42.773	36.6	13.5	113
2		692	396	1066.5	27.318	45.0	25.8	105	2		812	465	1155.4	34.732	45.0	25.8	107
3		740	515	929.8	22.070	51.9	36.1	101	3		868	605	1007.3	28.060	51.9	36.1	103
4		770	608	790.3	17.448	58.0	45.8	98	4		903	713	856.2	22.183	58.0	45.8	100
5		780	660	680.3	14.297	61.7	52.2	96	5		915	774	737.0	18.178	61.7	52.2	98
6		769	681	584.0	11.801	63.3	56.1	95	6		903	799	632.7	15.003	63.3	56.1	97
7		737	682	461.3	9.006	62.8	58.1	95	7		865	800	499.7	11.451	62.8	58.1	97
8		655	623	351.9	7.023	54.6	51.9	98	8		769	731	381.2	8.929	54.6	51.9	100
1	700	828	306	1417.1	53.423	36.6	13.5	114	1	750	951	351	1518.3	65.708	36.6	13.5	116
2		941	539	1244.3	43.380	45.0	25.8	109	2		1081	619	1333.1	53.355	45.0	25.8	111
3		1007	701	1084.7	35.046	51.9	36.1	105	3		1156	805	1162.2	43.106	51.9	36.1	107
4		1048	827	922.1	27.706	58.0	45.8	102	4		1203	950	987.9	34.077	58.0	45.8	104
5		1061	898	793.6	22.704	61.7	52.2	100	5		1218	1031	850.3	27.925	61.7	52.2	102
6		1047	927	681.4	18.739	63.3	56.1	99	6		1202	1064	730.0	23.048	63.3	56.1	100
7		1003	928	538.2	14.302	62.8	58.1	98	7		1152	1066	576.6	17.591	62.8	58.1	100
8		891	848	410.5	11.152	54.6	51.9	101	8		1023	973	439.8	13.716	54.6	51.9	103

- The A-weighted sound ratings shown have been calculated per AMCA International Standard 301.
- Values shown are for inlet LwiA sound power levels for installation type B - free inlet, ducted outlet.
- Performance certified is for installation type B - free inlet, ducted outlet.
- Performance ratings do not include the effects of appurtenances(accessories).
- Power rating (kW) does not include transmission losses.

Taeil Blower Co., LTD  
TSFD Series

TSFD-710

SIROCCO FAN  
FEG 67



Wheel dia. 710 mm | Tip Speed = 0.0372 × rpm | Outlet Dim. 898×898 | Outlet Area 0.8064 m<sup>2</sup> | Class 1 1614 rpm | Class 2 2152 rpm | Not Applicable

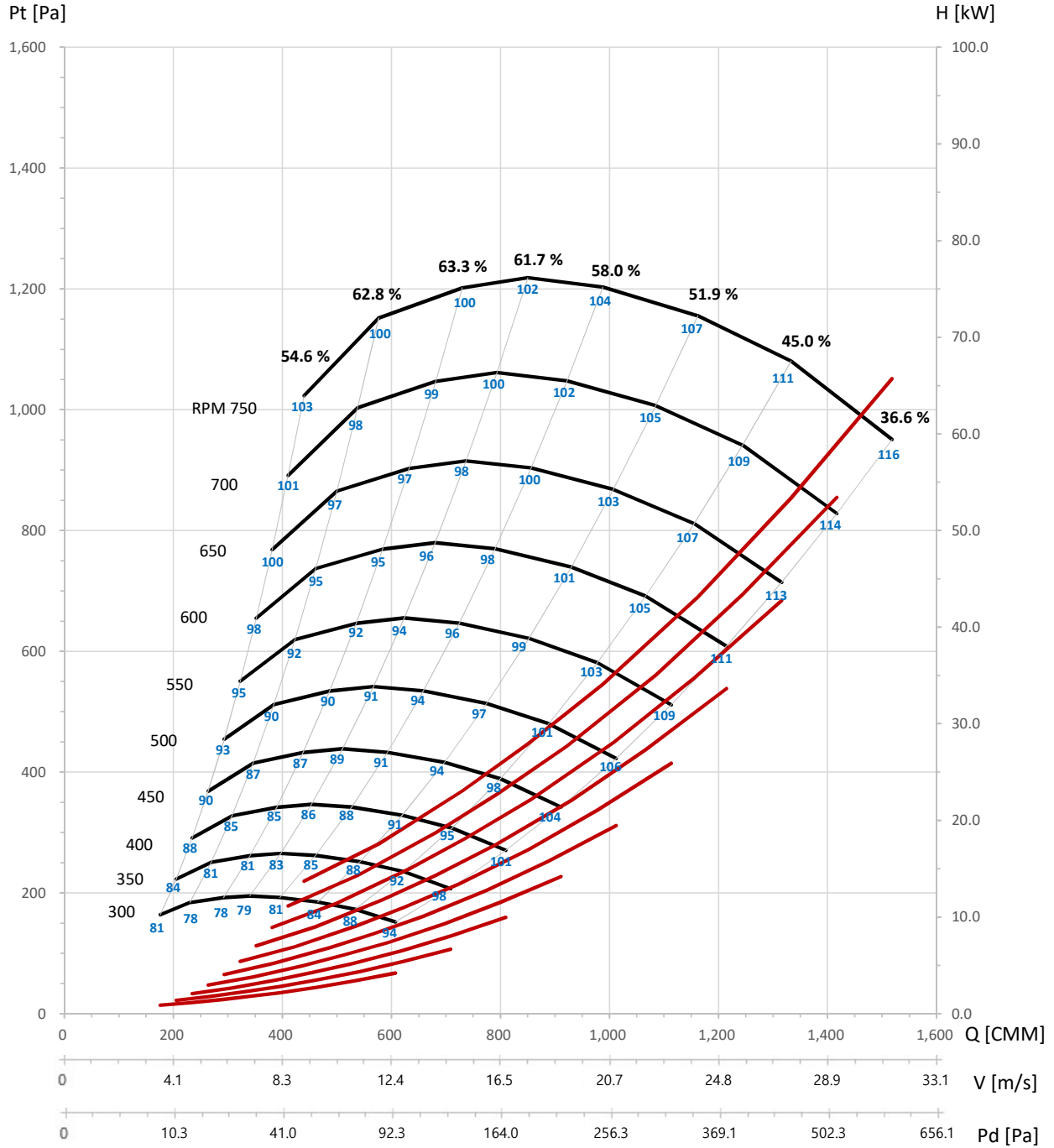

- The A-weighted sound ratings shown have been calculated per AMCA International Standard 301.
- Values shown are for inlet LwA sound power levels for installation type B - free inlet, ducted outlet.
- Performance certified is for installation type B - free inlet, ducted outlet.
- Performance ratings do not include the effects of appurtenances(accessories).
- Power rating (kW) does not include transmission losses.

Taeil Blower Co., LTD  
TSFD Series

TSFD-800

SIROCCO FAN  
FEG 67



Wheel dia. 800 mm | Tip Speed = 0.0419 × rpm | Outlet Dim. 1007×1007 | Outlet Area 1.0140 m<sup>2</sup> | Class 1 1432 rpm | Class 2 1910 rpm | Not Applicable

Det.									Det.								
	N [r/min]	Pt [Pa]	Ps [Pa]	Q [m <sup>3</sup> /min]	H [kW]	EtaT [%]	EtaS [%]	Lwi [dB(A)]		N [r/min]	Pt [Pa]	Ps [Pa]	Q [m <sup>3</sup> /min]	H [kW]	EtaT [%]	EtaS [%]	Lwi [dB(A)]
1	250	134	50	724.0	4.420	36.6	13.5	94	1	300	193	71	868.8	7.638	36.6	13.5	98
2		152	87	635.7	3.589	45.0	25.8	88	2		219	126	762.8	6.202	45.0	25.8	92
3		163	114	554.2	2.900	51.9	36.1	84	3		235	164	665.0	5.010	51.9	36.1	88
4		170	134	471.1	2.292	58.0	45.8	80	4		244	193	565.3	3.961	58.0	45.8	85
5		172	145	405.5	1.878	61.7	52.2	78	5		248	209	486.6	3.246	61.7	52.2	83
6		170	150	348.1	1.550	63.3	56.1	77	6		244	216	417.7	2.679	63.3	56.1	81
7		162	150	275.0	1.183	62.8	58.1	77	7		234	216	330.0	2.045	62.8	58.1	81
8		144	137	209.7	0.923	54.6	51.9	80	8		208	198	251.7	1.594	54.6	51.9	84
1	350	263	97	1013.6	12.128	36.6	13.5	102	1	400	343	127	1158.4	18.104	36.6	13.5	105
2		299	171	890.0	9.848	45.0	25.8	96	2		390	224	1017.1	14.701	45.0	25.8	99
3		319	223	775.9	7.956	51.9	36.1	92	3		417	291	886.7	11.876	51.9	36.1	95
4		333	263	659.5	6.290	58.0	45.8	89	4		434	343	753.7	9.389	58.0	45.8	92
5		337	285	567.7	5.154	61.7	52.2	86	5		440	372	648.8	7.694	61.7	52.2	90
6		332	294	487.3	4.254	63.3	56.1	85	6		434	384	557.0	6.350	63.3	56.1	88
7		318	295	384.9	3.247	62.8	58.1	85	7		416	385	439.9	4.847	62.8	58.1	88
8		283	269	293.6	2.532	54.6	51.9	88	8		369	351	335.6	3.779	54.6	51.9	91
1	450	435	161	1303.2	25.777	36.6	13.5	108	1	500	536	198	1447.9	35.359	36.6	13.5	110
2		494	283	1144.3	20.931	45.0	25.8	102	2		610	349	1271.4	28.712	45.0	25.8	104
3		528	368	997.5	16.910	51.9	36.1	98	3		652	454	1108.4	23.196	51.9	36.1	101
4		550	434	848.0	13.368	58.0	45.8	95	4		679	536	942.2	18.338	58.0	45.8	97
5		557	471	729.9	10.955	61.7	52.2	92	5		688	582	810.9	15.027	61.7	52.2	95
6		549	486	626.6	9.042	63.3	56.1	91	6		678	600	696.2	12.403	63.3	56.1	94
7		526	487	494.9	6.901	62.8	58.1	91	7		650	601	549.9	9.466	62.8	58.1	94
8		468	445	377.5	5.381	54.6	51.9	94	8		577	549	419.5	7.381	54.6	51.9	97
1	550	649	240	1592.7	47.063	36.6	13.5	112	1	600	773	285	1737.5	61.101	36.6	13.5	114
2		738	423	1398.5	38.216	45.0	25.8	107	2		878	503	1525.7	49.614	45.0	25.8	109
3		789	550	1219.2	30.874	51.9	36.1	103	3		939	654	1330.1	40.083	51.9	36.1	105
4		821	648	1036.4	24.408	58.0	45.8	100	4		977	772	1130.6	31.688	58.0	45.8	102
5		832	704	892.0	20.001	61.7	52.2	97	5		990	838	973.1	25.967	61.7	52.2	100
6		821	726	765.8	16.508	63.3	56.1	96	6		977	865	835.4	21.432	63.3	56.1	98
7		786	728	604.9	12.599	62.8	58.1	96	7		936	866	659.9	16.357	62.8	58.1	98
8		699	664	461.4	9.824	54.6	51.9	99	8		831	791	503.4	12.754	54.6	51.9	101
1	650	907	335	1882.3	77.684	36.6	13.5	116	1	700	1052	388	2027.1	97.026	36.6	13.5	118
2		1030	590	1652.8	63.080	45.0	25.8	111	2		1195	684	1779.9	78.786	45.0	25.8	112
3		1102	768	1440.9	50.962	51.9	36.1	107	3		1278	890	1551.7	63.650	51.9	36.1	109
4		1147	906	1224.8	40.288	58.0	45.8	104	4		1330	1050	1319.0	50.319	58.0	45.8	106
5		1162	983	1054.2	33.014	61.7	52.2	102	5		1348	1140	1135.3	41.234	61.7	52.2	103
6		1146	1015	905.1	27.249	63.3	56.1	100	6		1329	1177	974.7	34.033	63.3	56.1	102
7		1098	1016	714.9	20.797	62.8	58.1	100	7		1274	1179	769.9	25.974	62.8	58.1	102
8		976	928	545.3	16.216	54.6	51.9	103	8		1132	1076	587.3	20.253	54.6	51.9	105

- The A-weighted sound ratings shown have been calculated per AMCA International Standard 301.
- Values shown are for inlet LwiA sound power levels for installation type B - free inlet, ducted outlet.
- Performance certified is for installation type B - free inlet, ducted outlet.
- Performance ratings do not include the effects of appurtenances(accessories).
- Power rating (kW) does not include transmission losses.

Taeil Blower Co., LTD  
TSFD Series

TSFD-800

SIROCCO FAN  
FEG 67



Wheel dia. 800 mm Tip Speed = 0.0419 × rpm Outlet Dim. 1007×1007 Outlet Area 1.0140 m<sup>2</sup> Class 1 1432 rpm Class 2 1910 rpm Not Applicable

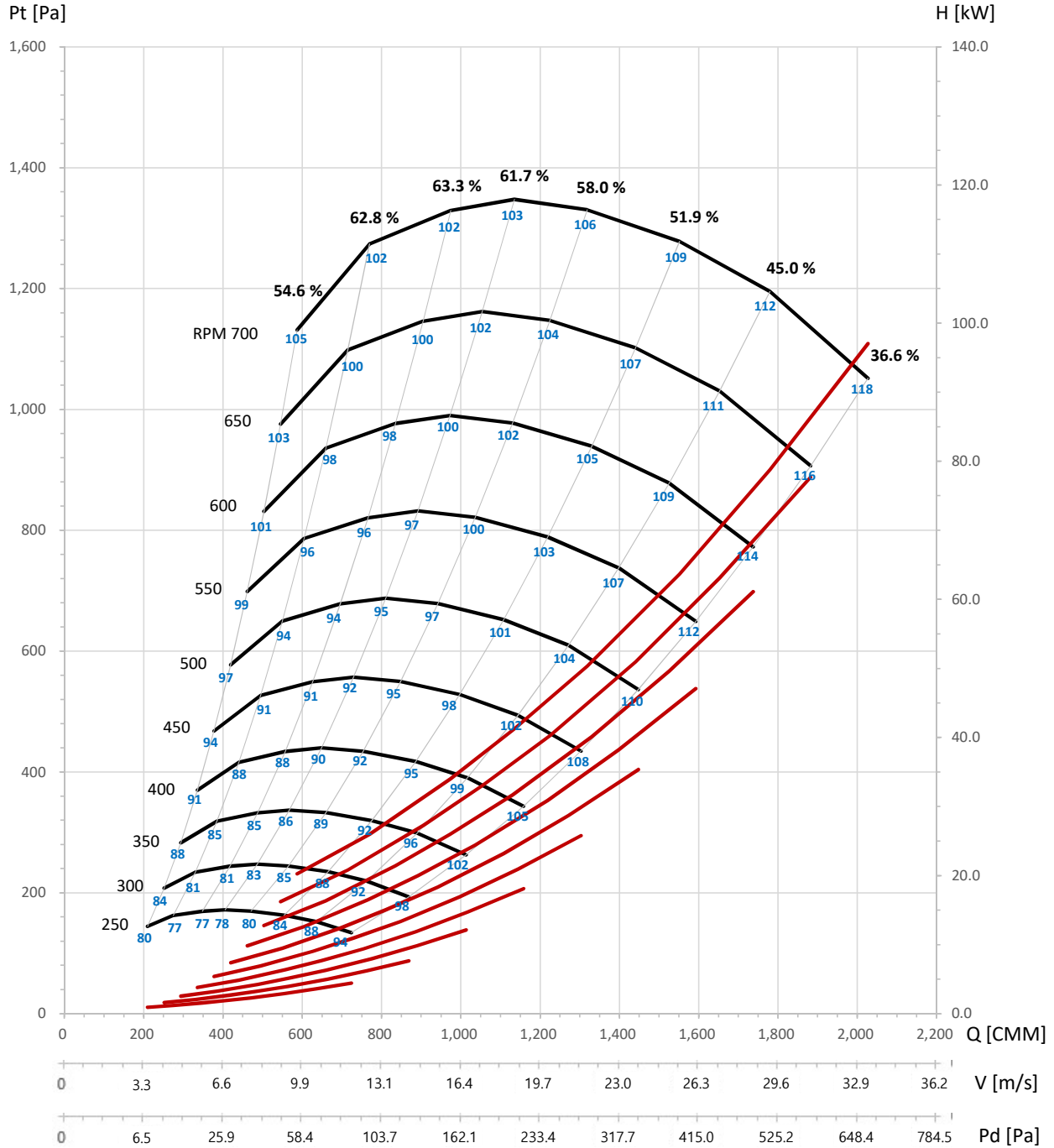

- The A-weighted sound ratings shown have been calculated per AMCA International Standard 301.
- Values shown are for inlet LwA sound power levels for installation type B - free inlet, ducted outlet.
- Performance certified is for installation type B - free inlet, ducted outlet.
- Performance ratings do not include the effects of appurtenances(accessories).
- Power rating (kW) does not include transmission losses.

Taeil Blower Co., LTD  
TSFD Series

TSFD-900

SIROCCO FAN  
FEG 67



Wheel dia. 900 mm | Tip Speed = 0.0471 × rpm | Outlet Dim' 1130×1130 | Outlet Area 1.2769 m<sup>2</sup> | Class 1 1273 rpm | Class 2 1698 rpm | Not Applicable

Det.	N								Det.	N							
	[r/min]	Pt [Pa]	Ps [Pa]	Q [m <sup>3</sup> /min]	H [kW]	EtaT [%]	EtaS [%]	Lwi [dB(A)]		[r/min]	Pt [Pa]	Ps [Pa]	Q [m <sup>3</sup> /min]	H [kW]	EtaT [%]	EtaS [%]	Lwi [dB(A)]
1	109	40	824.7	4.078	36.6	13.5	92	1	170	63	1030.8	7.965	36.6	13.5	97		
2	123	71	724.1	3.311	45.0	25.8	86	2	193	110	905.1	6.467	45.0	25.8	91		
3	132	92	631.3	2.675	51.9	36.1	82	3	206	144	789.1	5.225	51.9	36.1	87		
4	137	109	536.6	2.115	58.0	45.8	79	4	215	170	670.7	4.131	58.0	45.8	84		
5	139	118	461.9	1.733	61.7	52.2	76	5	218	184	577.3	3.385	61.7	52.2	82		
6	137	122	396.5	1.430	63.3	56.1	75	6	215	190	495.6	2.794	63.3	56.1	80		
7	132	122	313.2	1.092	62.8	58.1	75	7	206	190	391.5	2.132	62.8	58.1	80		
8	117	111	238.9	0.851	54.6	51.9	78	8	183	174	298.6	1.663	54.6	51.9	83		
1	244	90	1237.0	13.763	36.6	13.5	102	1	333	123	1443.1	21.855	36.6	13.5	105		
2	278	159	1086.1	11.176	45.0	25.8	96	2	378	217	1267.2	17.747	45.0	25.8	99		
3	297	207	946.9	9.029	51.9	36.1	92	3	404	282	1104.7	14.338	51.9	36.1	95		
4	309	244	804.9	7.138	58.0	45.8	88	4	421	332	939.0	11.335	58.0	45.8	92		
5	313	265	692.8	5.849	61.7	52.2	86	5	426	361	808.3	9.288	61.7	52.2	90		
6	309	274	594.8	4.828	63.3	56.1	85	6	421	372	693.9	7.666	63.3	56.1	89		
7	296	274	469.8	3.685	62.8	58.1	85	7	403	373	548.1	5.851	62.8	58.1	88		
8	263	250	358.4	2.873	54.6	51.9	88	8	358	341	418.1	4.562	54.6	51.9	92		
1	435	161	1649.3	32.624	36.6	13.5	108	1	550	203	1855.5	46.451	36.6	13.5	111		
2	494	283	1448.2	26.491	45.0	25.8	103	2	625	358	1629.2	37.718	45.0	25.8	105		
3	528	368	1262.5	21.402	51.9	36.1	99	3	668	466	1420.3	30.472	51.9	36.1	102		
4	550	434	1073.2	16.919	58.0	45.8	95	4	696	549	1207.3	24.090	58.0	45.8	98		
5	557	471	923.7	13.865	61.7	52.2	93	5	705	596	1039.2	19.741	61.7	52.2	96		
6	549	486	793.0	11.443	63.3	56.1	92	6	695	615	892.2	16.293	63.3	56.1	95		
7	526	487	626.4	8.734	62.8	58.1	92	7	666	616	704.7	12.435	62.8	58.1	95		
8	468	445	477.8	6.810	54.6	51.9	95	8	592	563	537.5	9.696	54.6	51.9	98		
1	679	251	2061.6	63.718	36.6	13.5	114	1	822	304	2267.8	84.809	36.6	13.5	116		
2	772	442	1810.2	51.740	45.0	25.8	108	2	934	535	1991.3	68.866	45.0	25.8	110		
3	825	575	1578.1	41.800	51.9	36.1	104	3	999	696	1736.0	55.636	51.9	36.1	106		
4	859	678	1341.5	33.046	58.0	45.8	101	4	1039	821	1475.6	43.984	58.0	45.8	103		
5	870	736	1154.7	27.079	61.7	52.2	99	5	1053	891	1270.1	36.042	61.7	52.2	101		
6	858	760	991.3	22.350	63.3	56.1	97	6	1039	919	1090.4	29.748	63.3	56.1	100		
7	823	761	783.0	17.058	62.8	58.1	97	7	995	921	861.3	22.704	62.8	58.1	100		
8	731	695	597.3	13.301	54.6	51.9	100	8	884	841	657.0	17.703	54.6	51.9	103		
1	978	361	2474.0	110.105	36.6	13.5	118	1	1147	424	2680.1	139.989	36.6	13.5	120		
2	1111	636	2172.3	89.406	45.0	25.8	112	2	1304	747	2353.3	113.672	45.0	25.8	114		
3	1188	828	1893.8	72.231	51.9	36.1	109	3	1395	971	2051.6	91.835	51.9	36.1	110		
4	1237	977	1609.8	57.103	58.0	45.8	105	4	1452	1146	1743.9	72.601	58.0	45.8	107		
5	1253	1060	1385.6	46.793	61.7	52.2	103	5	1471	1244	1501.0	59.493	61.7	52.2	105		
6	1236	1094	1189.5	38.621	63.3	56.1	102	6	1451	1284	1288.7	49.103	63.3	56.1	104		
7	1184	1096	939.6	29.476	62.8	58.1	102	7	1390	1286	1017.9	37.476	62.8	58.1	104		
8	1052	1001	716.7	22.984	54.6	51.9	105	8	1235	1174	776.4	29.222	54.6	51.9	107		

- The A-weighted sound ratings shown have been calculated per AMCA International Standard 301.
- Values shown are for inlet LwiA sound power levels for installation type B - free inlet, ducted outlet.
- Performance certified is for installation type B - free inlet, ducted outlet.
- Performance ratings do not include the effects of appurtenances(accessories).
- Power rating (kW) does not include transmission losses.



Taeil Blower Co., LTD  
TSFD Series

TSFD-900

SIROCCO FAN  
FEG 67



Wheel dia. 900 mm Tip Speed = 0.0471 × rpm Outlet Dim' 1130×1130 Outlet Area 1.2769 m<sup>2</sup> Class 1 1273 rpm Class 2 1698 rpm Not Applicable

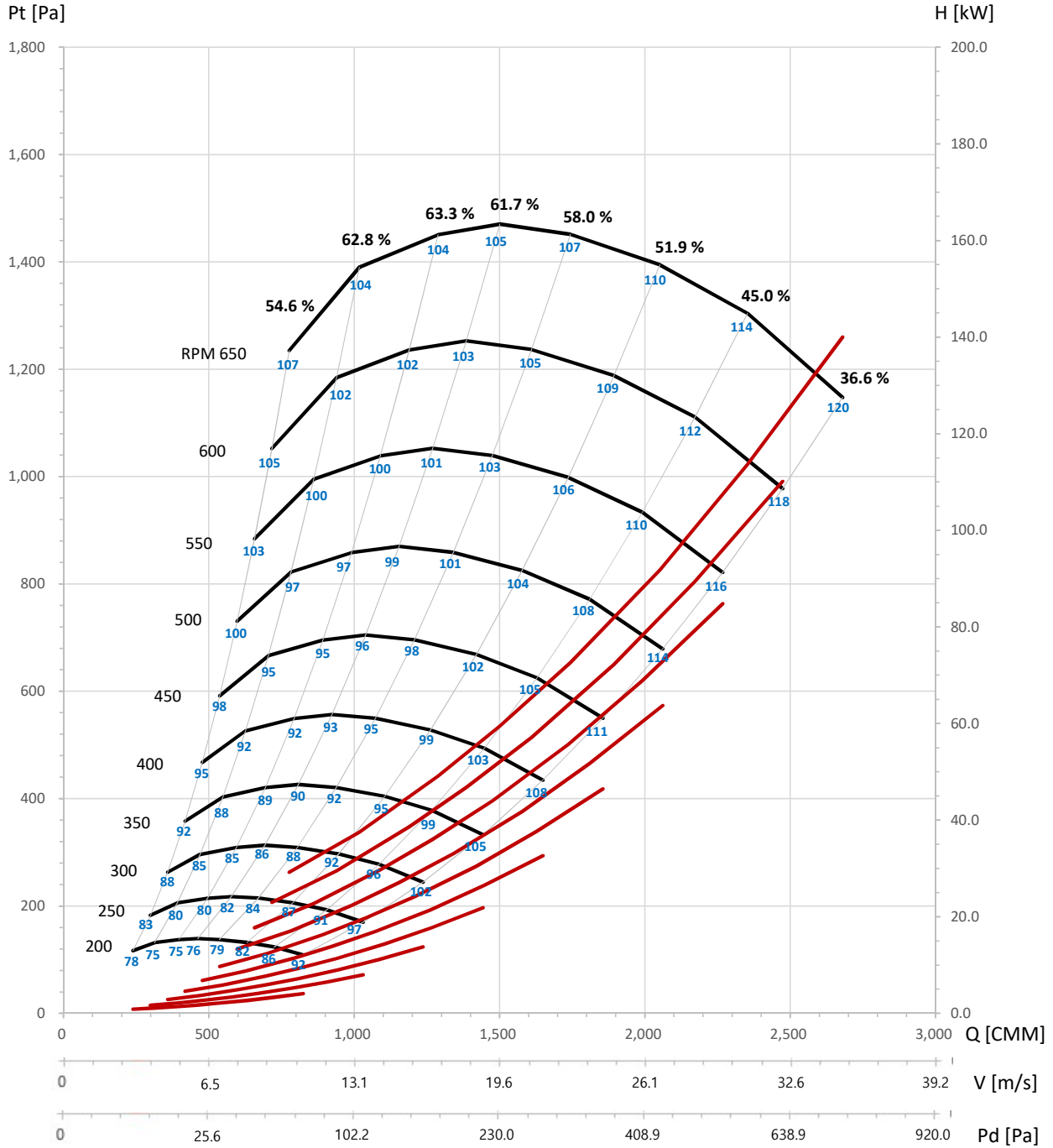

- The A-weighted sound ratings shown have been calculated per AMCA International Standard 301.
- Values shown are for inlet LwA sound power levels for installation type B - free inlet, ducted outlet.
- Performance certified is for installation type B - free inlet, ducted outlet.
- Performance ratings do not include the effects of appurtenances(accessories).
- Power rating (kW) does not include transmission losses.

Taeil Blower Co., LTD  
TSFD Series

TSFD-1000

SIROCCO FAN  
FEG 67



Wheel dia. 1000 mm Tip Speed = 0.0524 × rpm Outlet Dim. 1267×1267 Outlet Area 1.6053 m<sup>2</sup> Class 1 1146 rpm Class 2 1528 rpm Not Applicable

Det.									Det.								
	N [r/min]	Pt [Pa]	Ps [Pa]	Q [m <sup>3</sup> /min]	H [kW]	EtaT [%]	EtaS [%]	Lwi [dB(A)]		N [r/min]	Pt [Pa]	Ps [Pa]	Q [m <sup>3</sup> /min]	H [kW]	EtaT [%]	EtaS [%]	Lwi [dB(A)]
1	134	50	1131.2	6.906	36.6	13.5	95	1	210	77	1414.0	13.488	36.6	13.5	101		
2	152	87	993.3	5.608	45.0	25.8	89	2	238	136	1241.6	10.953	45.0	25.8	95		
3	163	114	865.9	4.531	51.9	36.1	85	3	255	177	1082.4	8.849	51.9	36.1	90		
4	170	134	736.1	3.582	58.0	45.8	82	4	265	209	920.1	6.995	58.0	45.8	87		
5	172	145	633.6	2.935	61.7	52.2	80	5	269	227	791.9	5.732	61.7	52.2	85		
6	170	150	543.9	2.422	63.3	56.1	78	6	265	235	679.9	4.731	63.3	56.1	84		
7	162	150	429.6	1.849	62.8	58.1	78	7	254	235	537.0	3.611	62.8	58.1	84		
8	144	137	327.7	1.442	54.6	51.9	81	8	226	214	409.6	2.816	54.6	51.9	87		
1	302	111	1696.8	23.308	36.6	13.5	105	1	411	152	1979.6	37.012	36.6	13.5	108		
2	343	196	1489.9	18.926	45.0	25.8	99	2	467	267	1738.2	30.054	45.0	25.8	103		
3	367	255	1298.9	15.290	51.9	36.1	95	3	499	348	1515.4	24.281	51.9	36.1	99		
4	382	301	1104.1	12.088	58.0	45.8	92	4	520	410	1288.1	19.195	58.0	45.8	95		
5	387	327	950.3	9.906	61.7	52.2	89	5	526	445	1108.7	15.730	61.7	52.2	93		
6	381	338	815.9	8.176	63.3	56.1	88	6	519	460	951.8	12.983	63.3	56.1	92		
7	366	338	644.4	6.240	62.8	58.1	88	7	498	460	751.8	9.908	62.8	58.1	92		
8	325	309	491.6	4.865	54.6	51.9	91	8	442	420	573.5	7.726	54.6	51.9	95		
1	536	198	2262.4	55.249	36.6	13.5	112	1	679	251	2545.2	78.665	36.6	13.5	114		
2	610	349	1986.5	44.862	45.0	25.8	106	2	772	442	2234.9	63.876	45.0	25.8	109		
3	652	454	1731.8	36.244	51.9	36.1	102	3	825	575	1948.3	51.605	51.9	36.1	105		
4	679	536	1472.1	28.653	58.0	45.8	99	4	859	678	1656.2	40.797	58.0	45.8	102		
5	688	582	1267.1	23.480	61.7	52.2	96	5	870	736	1425.5	33.431	61.7	52.2	99		
6	678	600	1087.8	19.379	63.3	56.1	95	6	858	760	1223.8	27.593	63.3	56.1	98		
7	650	601	859.3	14.790	62.8	58.1	95	7	823	761	966.7	21.059	62.8	58.1	98		
8	577	549	655.4	11.533	54.6	51.9	98	8	731	695	737.4	16.421	54.6	51.9	101		
1	838	310	2828.0	107.908	36.6	13.5	117	1	1014	375	3110.8	143.625	36.6	13.5	119		
2	953	546	2483.2	87.622	45.0	25.8	111	2	1153	660	2731.5	116.625	45.0	25.8	113		
3	1019	710	2164.8	70.789	51.9	36.1	107	3	1233	859	2381.3	94.220	51.9	36.1	110		
4	1060	837	1840.2	55.963	58.0	45.8	104	4	1283	1013	2024.2	74.487	58.0	45.8	107		
5	1074	909	1583.9	45.859	61.7	52.2	102	5	1300	1100	1742.3	61.038	61.7	52.2	104		
6	1060	938	1359.8	37.850	63.3	56.1	100	6	1282	1135	1495.8	50.378	63.3	56.1	103		
7	1015	940	1074.1	28.888	62.8	58.1	100	7	1229	1137	1181.5	38.450	62.8	58.1	103		
8	902	858	819.3	22.525	54.6	51.9	104	8	1092	1038	901.2	29.981	54.6	51.9	106		

- The A-weighted sound ratings shown have been calculated per AMCA International Standard 301.
- Values shown are for inlet LwiA sound power levels for installation type B - free inlet, ducted outlet.
- Performance certified is for installation type B - free inlet, ducted outlet.
- Performance ratings do not include the effects of appurtenances(accessories).
- Power rating (kW) does not include transmission losses.

Taeil Blower Co., LTD  
TSFD Series

TSFD-1000

SIROCCO FAN  
FEG 67



Wheel dia. 1000 mm Tip Speed = 0.0524 × rpm Outlet Dim. 1267×1267 Outlet Area 1.6053 m<sup>2</sup> Class 1 1146 rpm Class 2 1528 rpm Not Applicable

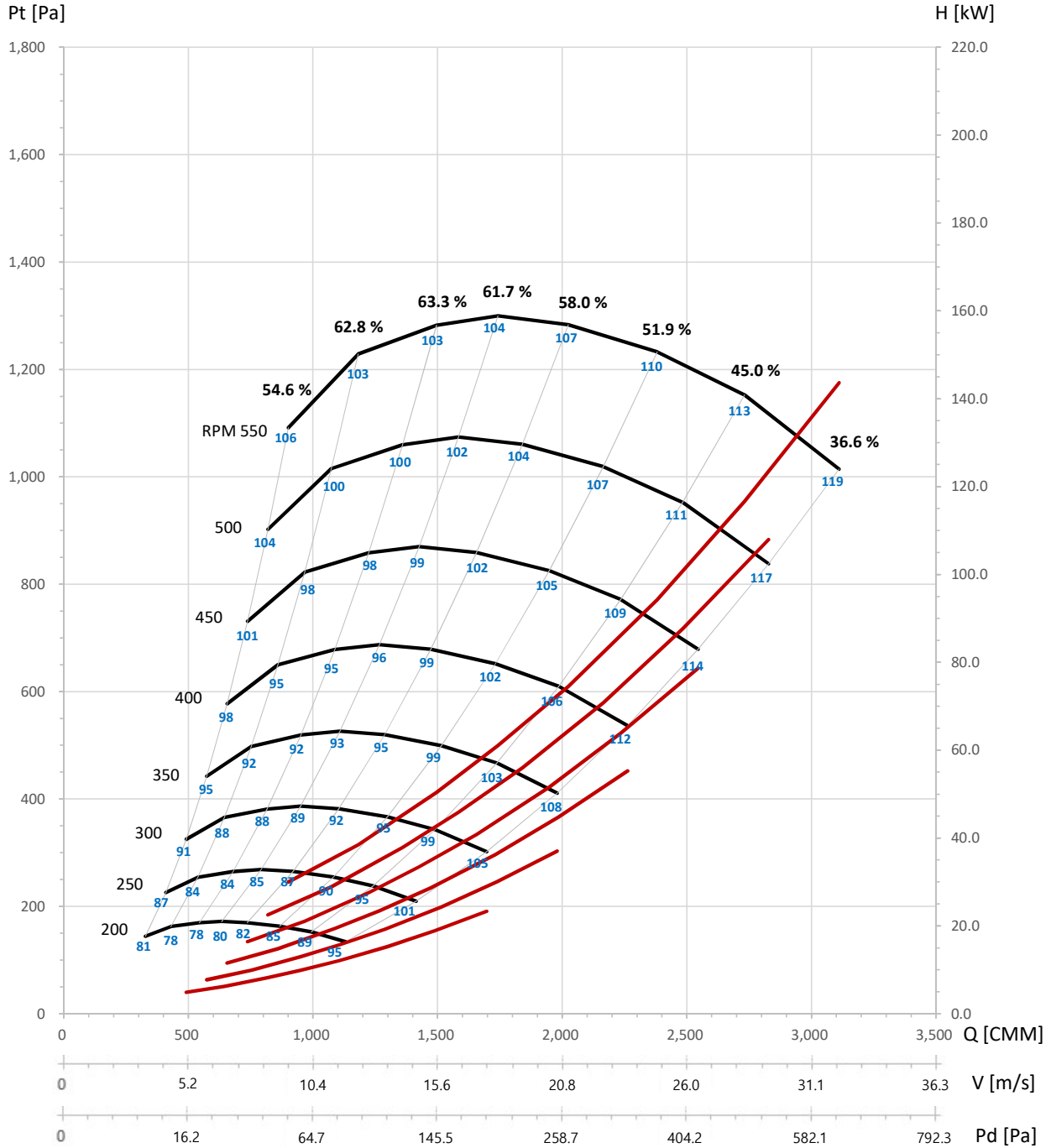



OFFICE : 50, Jeongmal-gil, Docheon-myeon, Changnyeong-gun, Gyeongsangnam-do, Korea

TEL : 82 055-521-7300 / FAX : 82 055-521-6977

Homepage : [www.tlbfmg.co.kr](http://www.tlbfmg.co.kr) / E-mail : [Sales@tae-il.co.kr](mailto:Sales@tae-il.co.kr)