

TW-D

Twin- Direct Drive Fan

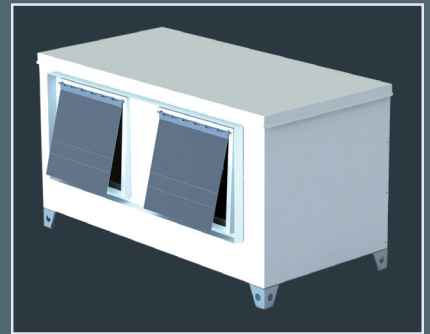

> TW-D

Twin- Direct Drive Fan

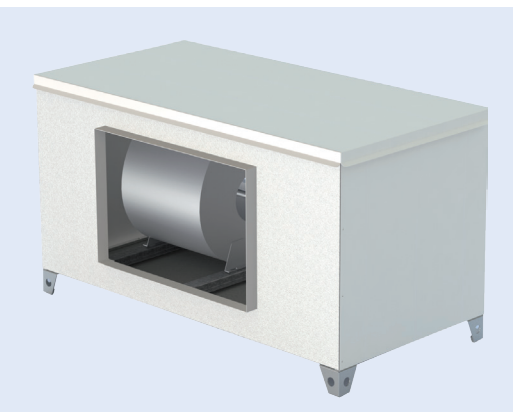
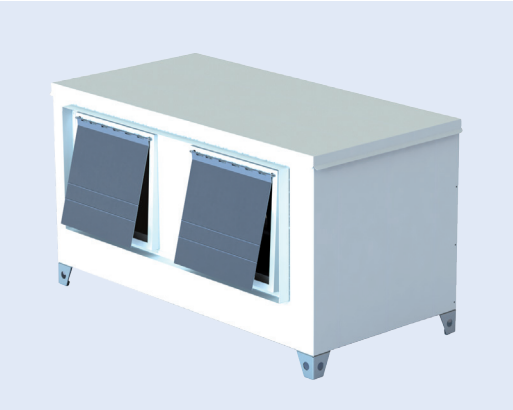

GENERAL DESCRIPTION

The fan of the TWD Series are particularly designed for installation where it is mandatory to guarantee an uninterrupted air exhaust even in case of failure. Its done by mean of fan in duty and another one in stand by which starts automatically in case of breakdown of the first fan. Duty and stand-by fans can be manually exchanged with a dedicated control panel, available in different versions(Automatic Changeover panel AC up on request).

TW-D: Suitable for indoor & outdoor application.

CONSTRUCTION

- Cabinet is manufacture in PPGI sheet, removable access panel on top to allow easy access to fan and motor.
- Acoustic lining in self-extinguishing techno polymer.
- Double inlet Blower, Forward curved, with direct drive built in asynchronous Motor, single phase or three phases, particularly suitable for speed regulation (using the suitable speed regulator shown in the catalogue).
- The blower is fitted using suitable support feet and is completely isolated from casing by anti-vibration mounts and gaskets.

OPTION FEATURES

- Version with double skin panels (20 mm thick)
- Different discharge orientation
- TW-D construction available in AL extruded profile on request with PPGI/AL sheet.



Maico Ventilation Pvt. Ltd. certifies that DYNAIR Model "TWD 3/4" shown herein is licensed to bear the AMCA Seal. The ratings shown are based on tests and procedures performed in accordance with AMCA Publication 211 and comply with the requirements of the **AMCA Certified Ratings Program**.



Maico Ventilation Pvt. Ltd. certifies that DYNAIR Model "TWD 3/8 to 12/12" shown herein are licensed to bear the AMCA Seal. The ratings shown are based on tests and procedures performed in accordance with AMCA Publication 211 and AMCA Publication 311 and comply with the requirements of the **AMCA Certified Ratings Program**.

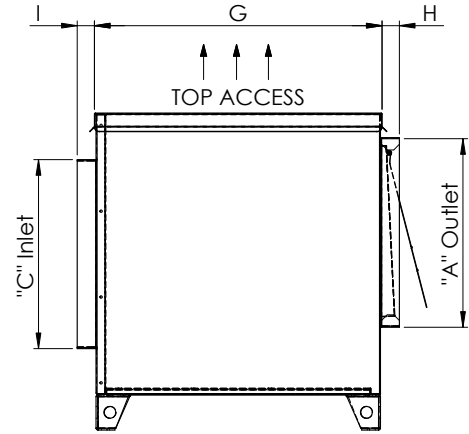
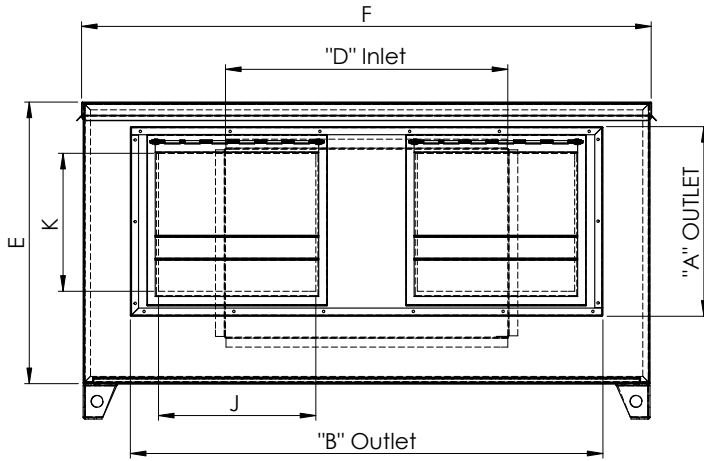

TYPE	A	B	C	D	E	F	G	H	I	J	K	Wt. Kg (with GI cabinet)	Wt. Kg (with AL cabinet)
TWD 3/4 B4M	125	420	165	300	300	700	300	40	40	154	75	15	10
TWD 3/8 B4M	200	750	200	300	350	900	350	40	40	230	106	22	18
TWD 7/7 B4M	350	800	350	400	550	1000	550	40	40	230	210	34	28
TWD 7/7 A6M	350	800	350	400	550	1000	550	40	40	230	210	34	27
TWD 9/7 B4M	350	800	350	400	600	1000	600	40	40	230	264	48	40
TWD 9/7 A6M	350	800	350	400	600	1000	600	40	40	230	264	44	35
TWD 9/9 B4M	400	1000	400	500	600	1200	600	40	40	300	264	54	45
TWD 9/9 A6M	400	1000	400	500	600	1200	600	40	40	300	264	52	43
TWD 10/8 B4M	400	1000	400	600	600	1200	600	40	40	265	294	64	51
TWD 10/8 A6M	400	1000	400	600	600	1200	600	40	40	265	294	59	45
TWD 10/10 B4M	400	1000	400	600	600	1200	600	40	40	330	294	66	53
TWD 10/10 A6M	400	1000	400	600	600	1200	600	40	40	330	294	61	47
TWD 12/9 A6M	400	1200	400	600	750	1400	750	40	40	310	343	94	72
TWD 12/9 A6T	400	1200	400	600	750	1400	750	40	40	310	343	97	75
TWD 12/12 A6M	400	1200	400	600	750	1500	750	40	40	400	343	100	77
TWD 12/12 A6T	400	1200	400	600	750	1500	750	40	40	400	343	104	80

Dimensions in mm

NOTE : All ARE IN G.I & ALUMINIUM CONSTRUCTION WITHOUT PROFILE.

Values shown are for inlet Lwi sound power levels for Installation Type D: ducted inlet, ducted outlet. Ratings include the effects of duct end correction.

The sound power levels ratings shown are in decibels, referred to 10-12 watts, calculated per AMCA International Standard 301.

Speed (RPM) shown is nominal. Performance is based on actual speed of test. Performance ratings do not include the effects of appurtenances (accessories). Performance certified is for installation type D - Ducted inlet, ducted outlet.

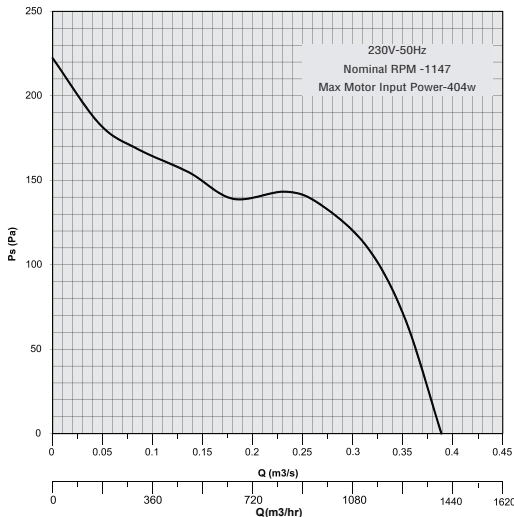
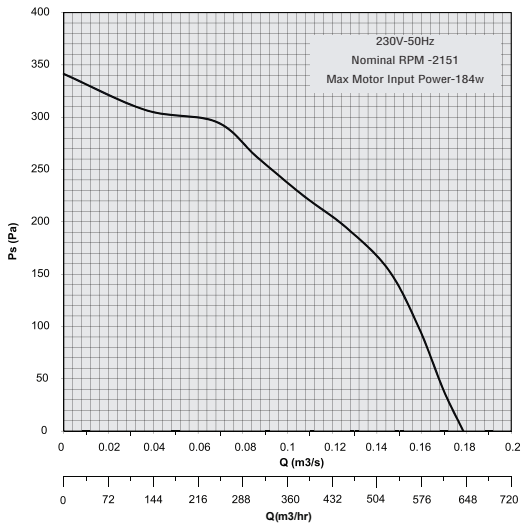
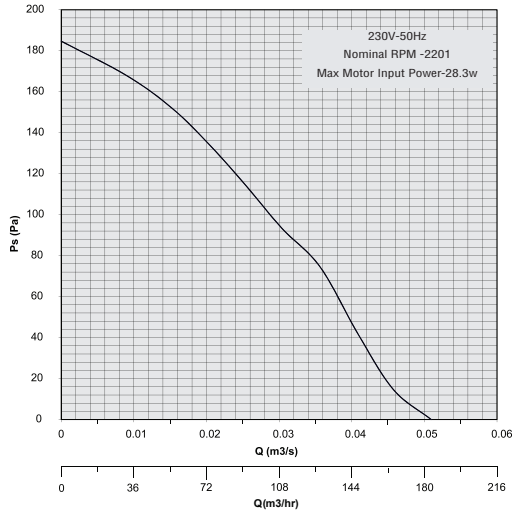

TWD 3/4 B4M

Q (Cmh)	Power (Watts)		A (amp)	V/Ph/F	IP/CL	uF	Reg	Power Module
	(P inp)	(P out)						
183	28.3	28	0.12	240/1/50	20/F	1	AC04	N A

Lp dB (A) at 3m (free Field)	Octave Band Frequency at max. airflow Hz (Lw,dB)							
	63	125	250	500	1K	2K	4K	8K
51	84	86	62	63	53	50	48	44

Sound performance of TWD 3/4 B4M is not Certified by AMCA International.

The AMCA Certified Ratings Seal applies to air performance ratings only.

TWD 3/8 B4M

Q (Cmh)	Power (Watts)		A (amp)	V/Ph/F	IP/CL	uF	Reg	Power Module
	(P inp)	(P out)						
648	184	190	0.76	240/1/50	44/B	3	AC04	N A

Lp dB (A) at 3m (free Field)	Octave Band Frequency at max. airflow Hz (Lw,dB)							
	63	125	250	500	1K	2K	4K	8K
52	85	87	63	64	54	51	49	45

Lp-dBA levels are not licensed by AMCA International.

TWD 7/7 B4M

Q (Cmh)	Power (Watts)		A (amp)	V/Ph/F	IP/CL	uF	Reg	Power Module
	(P inp)	(P out)						
1548	404	147	1.72	240/1/50	32/F	3	AC04	N A

Lp dB (A) at 3m (free Field)	Octave Band Frequency at max. airflow Hz (Lw,dB)							
	63	125	250	500	1K	2K	4K	8K
50	84	84	71	60	56	55	52	49

Lp-dBA levels are not licensed by AMCA International.

Values shown are for inlet Lwi sound power levels for Installation Type D: ducted inlet, ducted outlet. Ratings include the effects of duct end correction.

The sound power levels ratings shown are in decibels, referred to 10-12 watts, calculated per AMCA International Standard 301.

Speed (RPM) shown is nominal. Performance is based on actual speed of test. Performance ratings do not include the effects of appurtenances (accessories). Performance certified is for installation type D - Ducted inlet, ducted outlet.

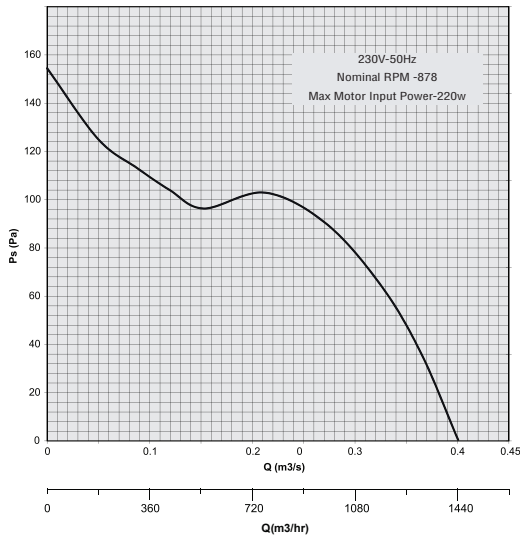

TWD 7/7 A6M

Q (Cmh)	Power (Watts)		A (amp)	V/Ph/F	IP/CL	uF	Reg	Power Module
	(P inp)	(P out)						
1440	220	62	0.97	240/1/50	32/F	4	AC04	N A

Lp dB (A) at 3m (free Field)	Octave Band Frequency at max.airflow Hz (Lw,dB)							
	63	125	250	500	1K	2K	4K	8K
47	83	77	72	59	55	53	49	46

Lp-dBA levels are not licensed by AMCA International.

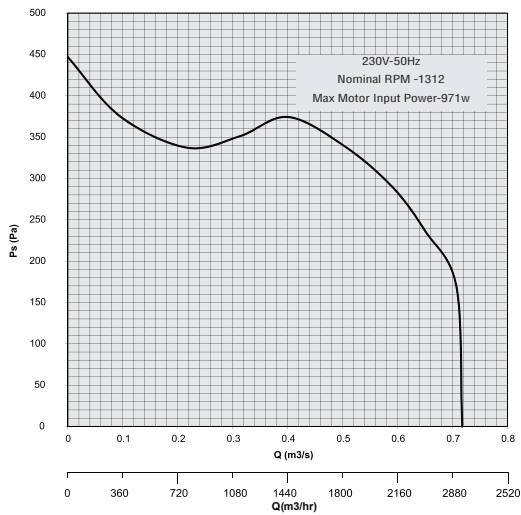

TWD 9/7 B4M

Q (Cmh)	Power (Watts)		A (amp)	V/Ph/F	IP/CL	uF	Reg	Power Module
	(P inp)	(P out)						
2592	971	373	4.38	240/1/50	20/F	6	AC04	N A

Lp dB (A) at 3m (free Field)	Octave Band Frequency at max.airflow Hz (Lw,dB)							
	63	125	250	500	1K	2K	4K	8K
58	99	89	77	68	67	64	63	57

Lp-dBA levels are not licensed by AMCA International.

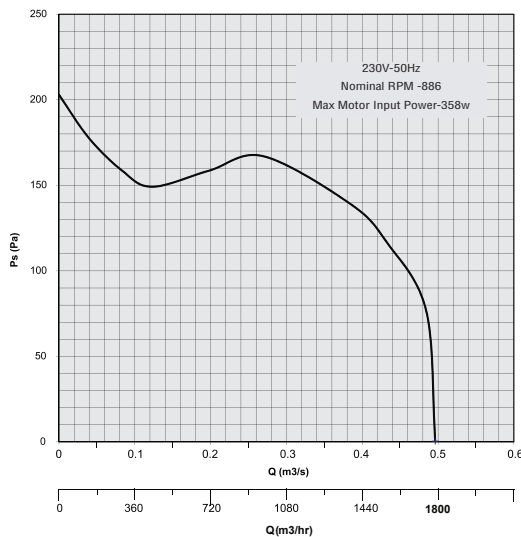

TWD 9/7 A6M

Q (Cmh)	Power (Watts)		A (amp)	V/Ph/F	IP/CL	uF	Reg	Power Module
	(P inp)	(P out)						
1764	358	147	1.64	240/1/50	20/F	5	AC04	N A

Lp dB (A) at 3m (free Field)	Octave Band Frequency at max.airflow Hz (Lw,dB)							
	63	125	250	500	1K	2K	4K	8K
53	89	88	67	61	57	55	51	44

Lp-dBA levels are not licensed by AMCA International.

Values shown are for inlet Lwi sound power levels for Installation Type D: ducted inlet, ducted outlet. Ratings include the effects of duct end correction.

The sound power levels ratings shown are in decibels, referred to 10-12 watts, calculated per AMCA International Standard 301.

Speed (RPM) shown is nominal. Performance is based on actual speed of test. Performance ratings do not include the effects of appurtenances (accessories). Performance certified is for installation type D - Ducted inlet, ducted outlet.

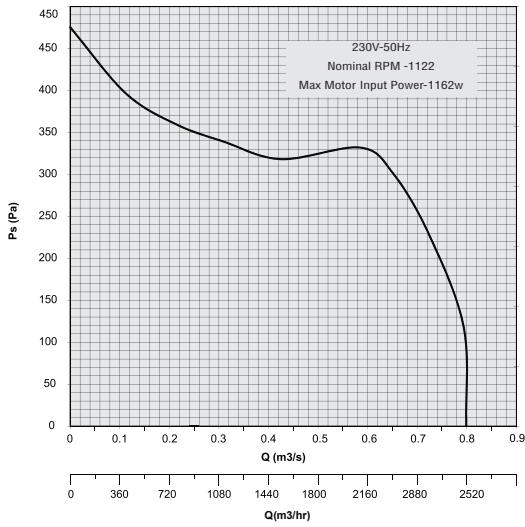

TWD 9/9 B4M

Q (Cmh)	Power (Watts)		A (amp)	V/Ph/F	IP/CL	uF	Reg	Power Module
	(P inp)	(P out)						
2880	1162	373	5.19	240/1/50	20/F	6	AC04	N A

Lp dB (A) at 3m (free Field)	Octave Band Frequency at max. airflow Hz (Lw,dB)							
	63	125	250	500	1K	2K	4K	8K
50	86	77	71	64	61	62	60	53

Lp-dBA levels are not licensed by AMCA International.

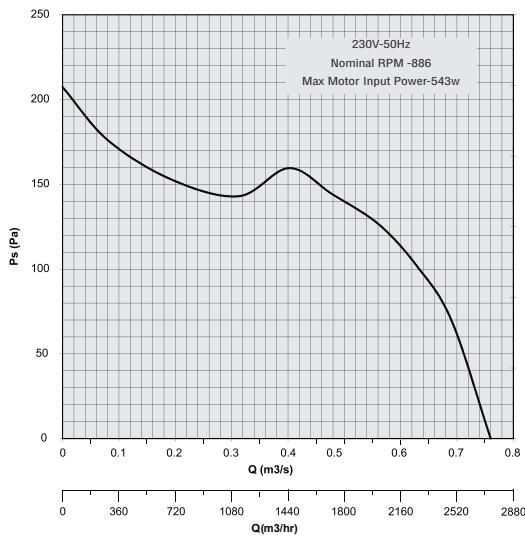

TWD 9/9 A6M

Q (Cmh)	Power (Watts)		A (amp)	V/Ph/F	IP/CL	uF	Reg	Power Module
	(P inp)	(P out)						
2736	543	245	2.49	240/1/50	20/F	8	AC04	N A

Lp dB (A) at 3m (free Field)	Octave Band Frequency at max. airflow Hz (Lw,dB)							
	63	125	250	500	1K	2K	4K	8K
49	85	76	69	64	61	61	60	52

Lp-dBA levels are not licensed by AMCA International.

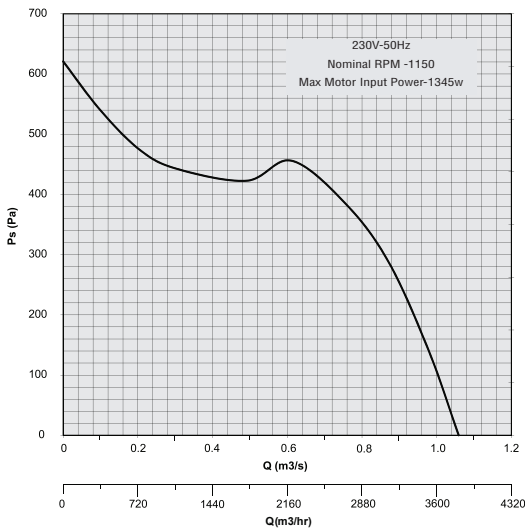

TWD 10/8 B4M

Q (Cmh)	Power (Watts)		A (amp)	V/Ph/F	IP/CL	uF	Reg	Power Module
	(P inp)	(P out)						
3816	1345	550	5.8	240/1/50	20/F	16	AC04	N A

Lp dB (A) at 3m (free Field)	Octave Band Frequency at max. airflow Hz (Lw,dB)							
	63	125	250	500	1K	2K	4K	8K
53	88	77	72	67	68	66	66	60

Lp-dBA levels are not licensed by AMCA International.

Values shown are for inlet Lwi sound power levels for Installation Type D: ducted inlet, ducted outlet. Ratings include the effects of duct end correction.

The sound power levels ratings shown are in decibels, referred to 10-12 watts, calculated per AMCA International Standard 301.

Speed (RPM) shown is nominal. Performance is based on actual speed of test. Performance ratings do not include the effects of appurtenances (accessories). Performance certified is for installation type D - Ducted inlet, ducted outlet.

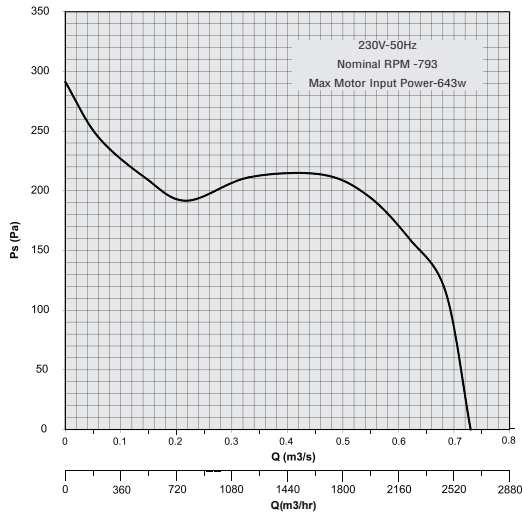

TWD 10/8 A6M

Q (Cmh)	Power (Watts)		A (amp)	V/Ph/F	IP/CL	uF	Reg	Power Module
	(P inp)	(P out)						
2628	643	245	2.9	240/1/50	20/F	8	AC04	N A

Lp dB (A) at 3m (free Field)	Octave Band Frequency at max.airflow Hz (Lw,dB)							
	63	125	250	500	1K	2K	4K	8K
46	83	72	65	61	60	58	57	48

Lp-dBA levels are not licensed by AMCA International.

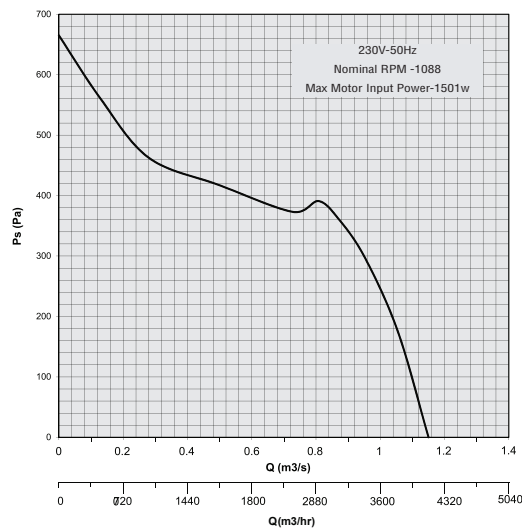

TWD 10/10 B4M

Q (Cmh)	Power (Watts)		A (amp)	V/Ph/F	IP/CL	uF	Reg	Power Module
	(P inp)	(P out)						
4140	1501	550	6.5	240/1/50	20/F	16	AC04	N A

Lp dB (A) at 3m (free Field)	Octave Band Frequency at max.airflow Hz (Lw,dB)							
	63	125	250	500	1K	2K	4K	8K
54	86	79	78	69	65	65	64	57

Lp-dBA levels are not licensed by AMCA International.

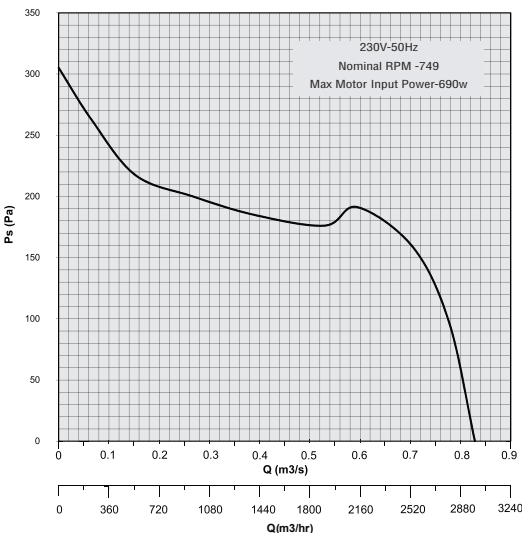

TWD 10/10 A6M

Q (Cmh)	Power (Watts)		A (amp)	V/Ph/F	IP/CL	uF	Reg	Power Module
	(P inp)	(P out)						
2988	690	245	3.1	240/1/50	20/F	8	AC04	N A

Lp dB (A) at 3m (free Field)	Octave Band Frequency at max.airflow Hz (Lw,dB)							
	63	125	250	500	1K	2K	4K	8K
46	85	75	67	61	57	57	55	45

Lp-dBA levels are not licensed by AMCA International.

Values shown are for inlet Lwi sound power levels for Installation Type D: ducted inlet, ducted outlet. Ratings include the effects of duct end correction.

The sound power levels ratings shown are in decibels, referred to 10-12 watts, calculated per AMCA International Standard 301.

Speed (RPM) shown is nominal. Performance is based on actual speed of test. Performance ratings do not include the effects of appurtenances (accessories). Performance certified is for installation type D - Ducted inlet, ducted outlet.

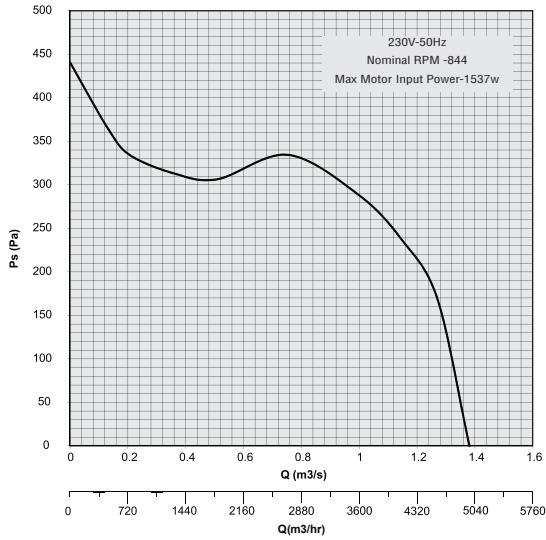

TWD 12/9 A6M

Q (Cmh)	Power (Watts)		A (amp)	V/Ph/F	IP/CL	uF	Reg	Power Module
	(P inp)	(P out)						
4968	1537	590	7.1	240/1/50	20/F	16	AC04	N A

Lp dB (A) at 3m (free Field)	Octave Band Frequency at max. airflow Hz (Lw,dB)							
	63	125	250	500	1K	2K	4K	8K
56	94	80	77	70	68	67	66	60

Lp-dBA levels are not licensed by AMCA International.

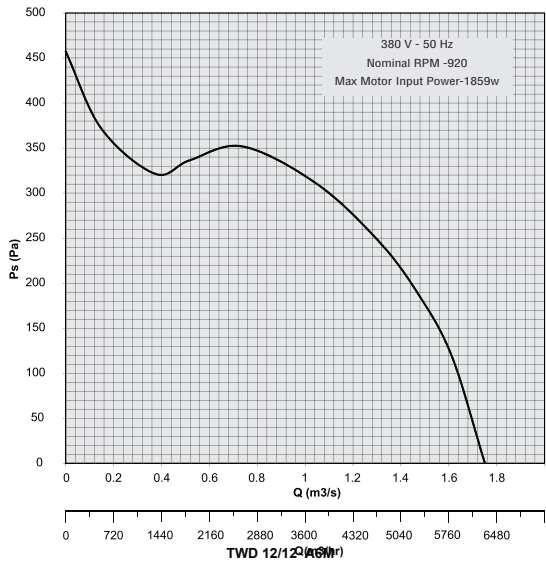

TWD 12/9 A6T

Q (Cmh)	Power (Watts)		A (amp)	V/Ph/F	IP/CL	uF	Reg	Power Module
	(P inp)	(P out)						
6264	1859	1100	3.4	415/3/50	20/F	NA	AC02	P.M

Lp dB (A) at 3m (free Field)	Octave Band Frequency at max. airflow Hz (Lw,dB)							
	63	125	250	500	1K	2K	4K	8K
59	98	83	79	72	72	70	70	65

Lp-dBA levels are not licensed by AMCA International.

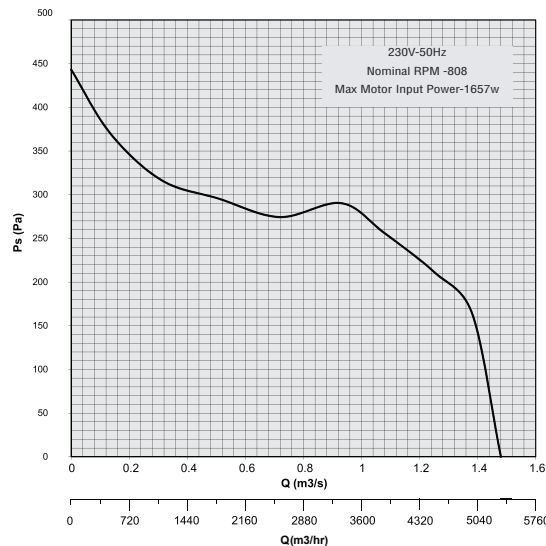

TWD 12/12 A6M

Q (Cmh)	Power (Watts)		A (amp)	V/Ph/F	IP/CL	uF	Reg	Power Module
	(P inp)	(P out)						
5328	1657	590	7.6	240/1/50	20/F	16	AC04	N A

Lp dB (A) at 3m (free Field)	Octave Band Frequency at max. airflow Hz (Lw,dB)							
	63	125	250	500	1K	2K	4K	8K
52	89	79	74	68	63	64	63	56

Lp-dBA levels are not licensed by AMCA International.

Values shown are for inlet Lwi sound power levels for Installation Type D: ducted inlet, ducted outlet. Ratings include the effects of duct end correction.

The sound power levels ratings shown are in decibels, referred to 10-12 watts, calculated per AMCA International Standard 301.

Speed (RPM) shown is nominal. Performance is based on actual speed of test. Performance ratings do not include the effects of appurtenances (accessories). Performance certified is for installation type D - Ducted inlet, ducted outlet.

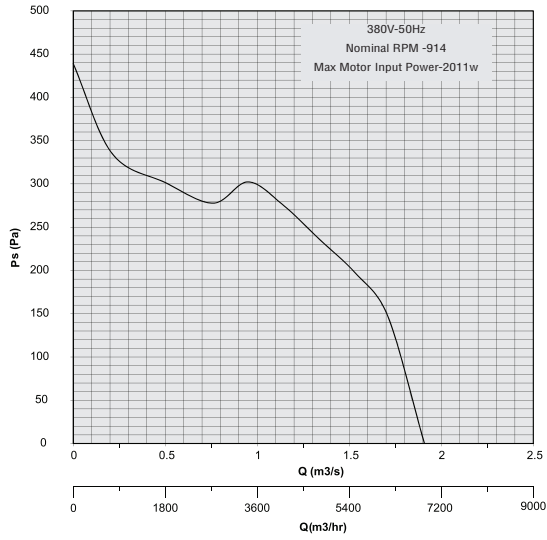

TWD 12/12 A6T

Q (Cmh)	Power (Watts)		A (amp)	V/Ph/F	IP/CL	uF	Reg	Power Module
	(P inp)	(P out)						
6840	2011	1100	3.6	415/3/50	20/F	NA	AC02	P.M

Lp dB (A) at 3m (free Field)	Octave Band Frequency at max. airflow Hz (Lw,dB)							
	63	125	250	500	1K	2K	4K	8K
62	98	85	82	82	71	70	69	64

Lp-dBA levels are not licensed by AMCA International.

Values shown are for inlet Lwi sound power levels for Installation Type D: ducted inlet, ducted outlet. Ratings include the effects of duct end correction.

The sound power levels ratings shown are in decibels, referred to 10-12 watts, calculated per AMCA International Standard 301.

Speed (RPM) shown is nominal. Performance is based on actual speed of test. Performance ratings do not include the effects of appurtenances (accessories). Performance certified is for installation type D - Ducted inlet, ducted outlet.

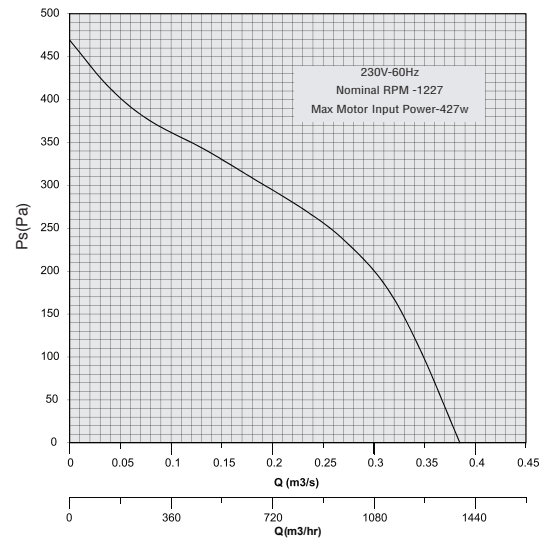
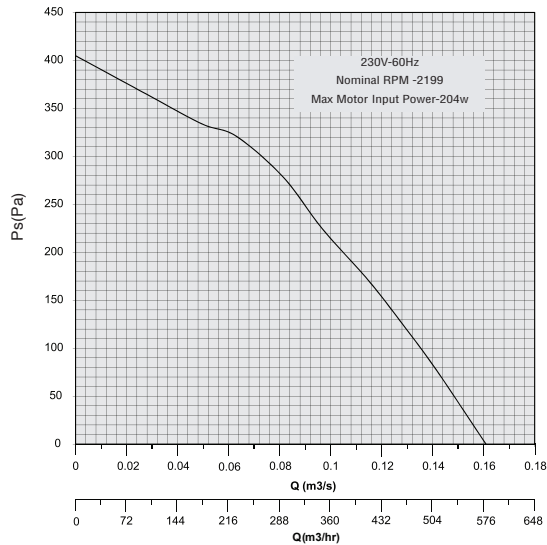
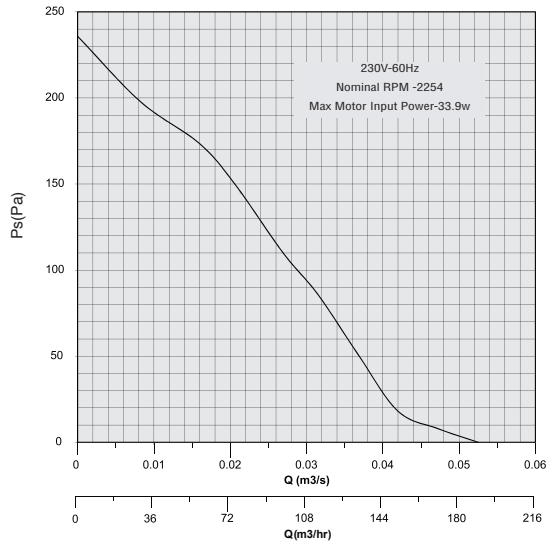

TWD 3/4 B4M

Q (Cmh)	Power (Watts)		A (amp)	V/Ph/F	IP/CL	uF	Reg	Power Module
	(P inp)	(P out)						
187	33.9	28	0.14	210-230/1/60	20/F	1	AC04	N A

Lp dB (A) at 3m (free Field)	Octave Band Frequency at max. airflow Hz (Lw,dB)							
	63	125	250	500	1K	2K	4K	8K
45	86	78	62	61	50	47	45	41

Sound performance of TWD 3/4 B4M is not Certified by AMCA International.

The AMCA Certified Ratings Seal applies to air performance ratings only.

TWD 3/8 B4M

Q (Cmh)	Power (Watts)		A (amp)	V/Ph/F	IP/CL	uF	Reg	Power Module
	(P inp)	(P out)						
579	204	190	0.85	210-230/1/60	44/B	3	AC04	N A

Lp dB (A) at 3m (free Field)	Octave Band Frequency at max. airflow Hz (Lw,dB)							
	63	125	250	500	1K	2K	4K	8K
46	87	79	63	62	51	48	46	42

Lp-dBA levels are not licensed by AMCA International.

TWD 7/7 B4M

Q (Cmh)	Power (Watts)		A (amp)	V/Ph/F	IP/CL	uF	Reg	Power Module
	(P inp)	(P out)						
1548	427	147	1.84	210-230/1/60	32/F	3	AC04	N A

Lp dB (A) at 3m (free Field)	Octave Band Frequency at max. airflow Hz (Lw,dB)							
	63	125	250	500	1K	2K	4K	8K
47	83	74	74	57	53	52	47	45

Lp-dBA levels are not licensed by AMCA International.

Values shown are for inlet Lwi sound power levels for Installation Type D: ducted inlet, ducted outlet. Ratings include the effects of duct end correction.

The sound power levels ratings shown are in decibels, referred to 10-12 watts, calculated per AMCA International Standard 301.

Speed (RPM) shown is nominal. Performance is based on actual speed of test. Performance ratings do not include the effects of appurtenances (accessories). Performance certified is for installation type D - Ducted inlet, ducted outlet.

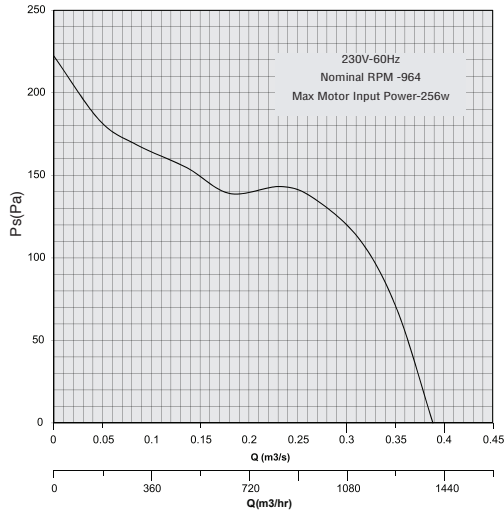

TWD 7/7 A6M

Q (Cmh)	Power (Watts)		A (amp)	V/Ph/F	IP/CL	uF	Reg	Power Module
	(P inp)	(P out)						
1404	220	62	1.1	210-230/1/60	32/F	4	AC04	N A

Lp dB (A) at 3m (free Field)	Octave Band Frequency at max.airflow Hz (Lw,dB)							
	63	125	250	500	1K	2K	4K	8K
48	82	75	75	59	54	53	49	46

Lp-dBA levels are not licensed by AMCA International.

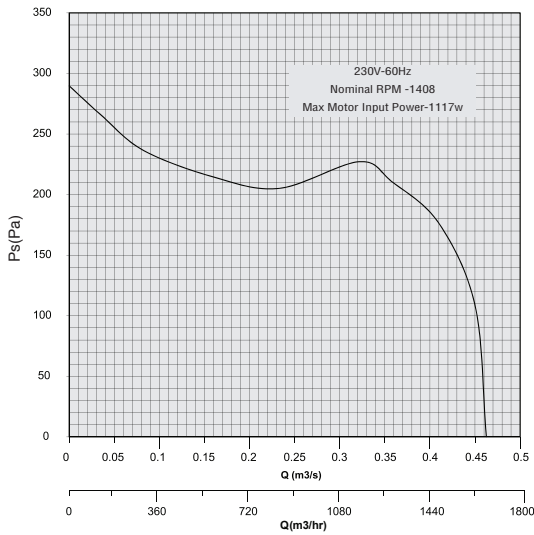

TWD 9/7 B4M

Q (Cmh)	Power (Watts)		A (amp)	V/Ph/F	IP/CL	uF	Reg	Power Module
	(P inp)	(P out)						
2376	1117	373	5.01	210-230/1/60	20/F	6	AC04	N A

Lp dB (A) at 3m (free Field)	Octave Band Frequency at max.airflow Hz (Lw,dB)							
	63	125	250	500	1K	2K	4K	8K
55	96	86	74	66	64	61	59	53

Lp-dBA levels are not licensed by AMCA International.

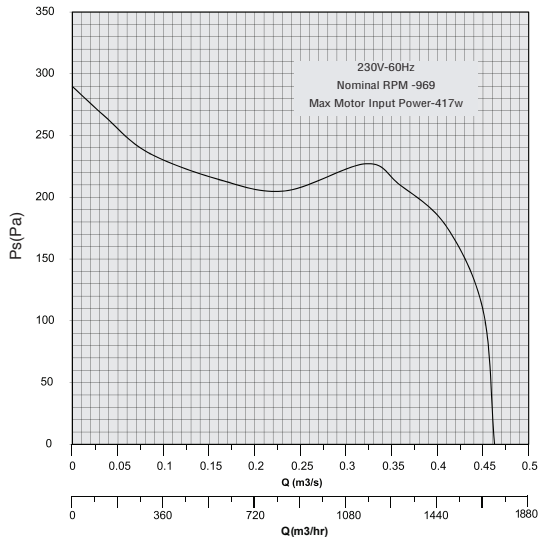

TWD 9/7 A6M

Q (Cmh)	Power (Watts)		A (amp)	V/Ph/F	IP/CL	uF	Reg	Power Module
	(P inp)	(P out)						
1674	417	147	1.89	210-230/1/60	20/F	5	AC04	N A

Lp dB (A) at 3m (free Field)	Octave Band Frequency at max.airflow Hz (Lw,dB)							
	63	125	250	500	1K	2K	4K	8K
48	87	79	70	61	56	54	50	43

Lp-dBA levels are not licensed by AMCA International.

Values shown are for inlet Lwi sound power levels for Installation Type D: ducted inlet, ducted outlet. Ratings include the effects of duct end correction.

The sound power levels ratings shown are in decibels, referred to 10-12 watts, calculated per AMCA International Standard 301.

Speed (RPM) shown is nominal. Performance is based on actual speed of test. Performance ratings do not include the effects of appurtenances (accessories). Performance certified is for installation type D - Ducted inlet, ducted outlet.

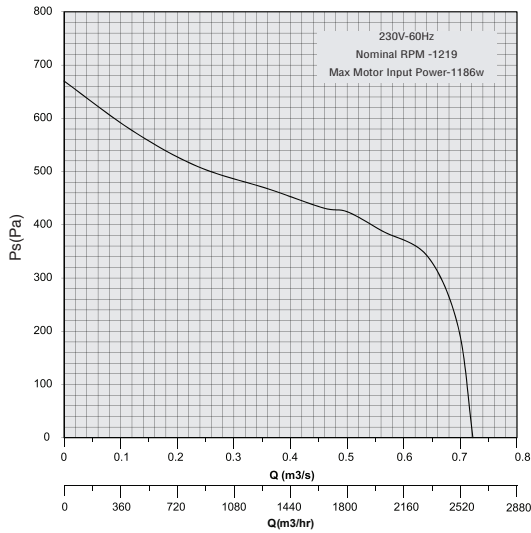

TWD 9/9 B4M

Q (Cmh)	Power (Watts)		A (amp)	V/Ph/F	IP/CL	uF	Reg	Power Module
	(P inp)	(P out)						
2592	1186	373	5.35	210-230/1/60	20/F	6	AC04	N A

Lp dB (A) at 3m (free Field)	Octave Band Frequency at max. airflow Hz (Lw,dB)							
	63	125	250	500	1K	2K	4K	8K
48	83	79	69	61	58	58	57	48

Lp-dBA levels are not licensed by AMCA International.

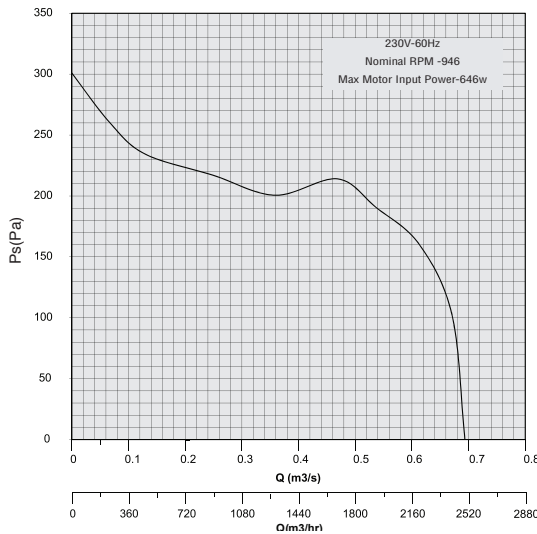

TWD 9/9 A6M

Q (Cmh)	Power (Watts)		A (amp)	V/Ph/F	IP/CL	uF	Reg	Power Module
	(P inp)	(P out)						
2484	646	245	2.9	210-230/1/60	20/F	8	AC04	N A

Lp dB (A) at 3m (free Field)	Octave Band Frequency at max. airflow Hz (Lw,dB)							
	63	125	250	500	1K	2K	4K	8K
44	82	71	65	59	56	56	54	45

Lp-dBA levels are not licensed by AMCA International.

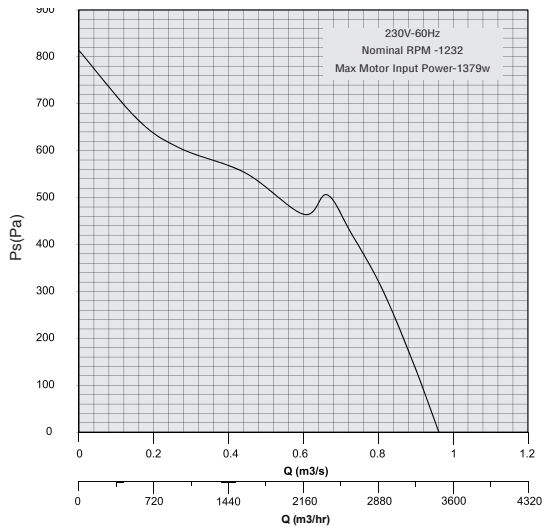

TWD 10/8 B4M

Q (Cmh)	Power (Watts)		A (amp)	V/Ph/F	IP/CL	uF	Reg	Power Module
	(P inp)	(P out)						
3456	1379	550	6.0	210-230/1/60	20/F	16	AC04	N A

Lp dB (A) at 3m (free Field)	Octave Band Frequency at max. airflow Hz (Lw,dB)							
	63	125	250	500	1K	2K	4K	8K
52	86	75	71	66	66	64	64	57

Lp-dBA levels are not licensed by AMCA International.

Values shown are for inlet Lwi sound power levels for Installation Type D: ducted inlet, ducted outlet. Ratings include the effects of duct end correction.

The sound power levels ratings shown are in decibels, referred to 10-12 watts, calculated per AMCA International Standard 301.

Speed (RPM) shown is nominal. Performance is based on actual speed of test. Performance ratings do not include the effects of appurtenances (accessories). Performance certified is for installation type D - Ducted inlet, ducted outlet.

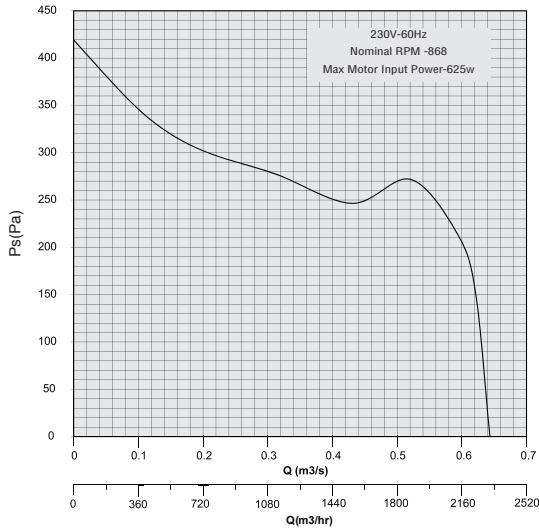

TWD 10/8 A6M

Q (Cmh)	Power (Watts)		A (amp)	V/Ph/F	IP/CL	uF	Reg	Power Module
	(P inp)	(P out)						
2304	625	245	2.9	210-230/1/60	20/F	8	AC04	N A

Lp dB (A) at 3m (free Field)	Octave Band Frequency at max.airflow Hz (Lw,dB)							
	63	125	250	500	1K	2K	4K	8K
43	82	70	61	58	57	56	53	44

Lp-dBA levels are not licensed by AMCA International.

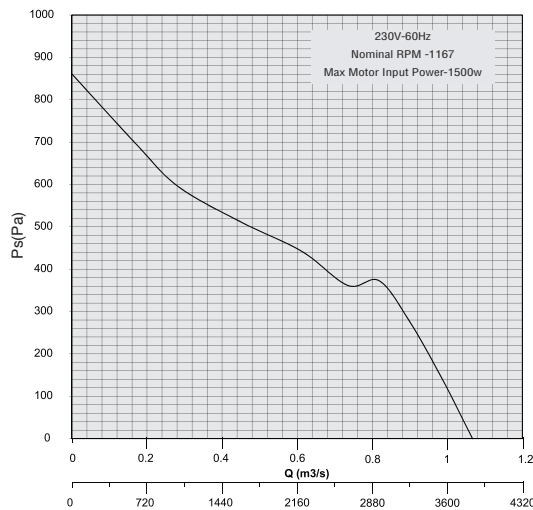

TWD 10/10 B4M

Q (Cmh)	Power (Watts)		A (amp)	V/Ph/F	IP/CL	uF	Reg	Power Module
	(P inp)	(P out)						
3816	1500	550	6.6	210-230/1/60	20/F	16	AC04	N A

Lp dB (A) at 3m (free Field)	Octave Band Frequency at max.airflow Hz (Lw,dB)							
	63	125	250	500	1K	2K	4K	8K
52	85	78	76	69	63	62	61	53

Lp-dBA levels are not licensed by AMCA International.

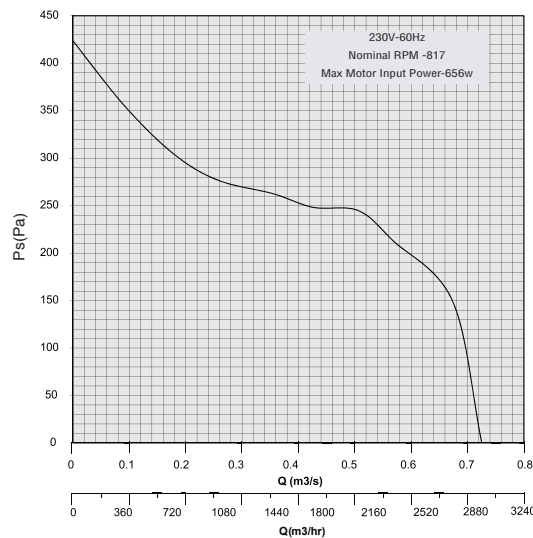

TWD 10/10 A6M

Q (Cmh)	Power (Watts)		A (amp)	V/Ph/F	IP/CL	uF	Reg	Power Module
	(P inp)	(P out)						
2592	656	245	3.0	210-230/1/60	20/F	8	AC04	N A

Lp dB (A) at 3m (free Field)	Octave Band Frequency at max.airflow Hz (Lw,dB)							
	63	125	250	500	1K	2K	4K	8K
44	82	74	66	59	54	54	51	42

Lp-dBA levels are not licensed by AMCA International.

Values shown are for inlet Lwi sound power levels for Installation Type D: ducted inlet, ducted outlet. Ratings include the effects of duct end correction.

The sound power levels ratings shown are in decibels, referred to 10-12 watts, calculated per AMCA International Standard 301.

Speed (RPM) shown is nominal. Performance is based on actual speed of test. Performance ratings do not include the effects of appurtenances (accessories). Performance certified is for installation type D - Ducted inlet, ducted outlet.

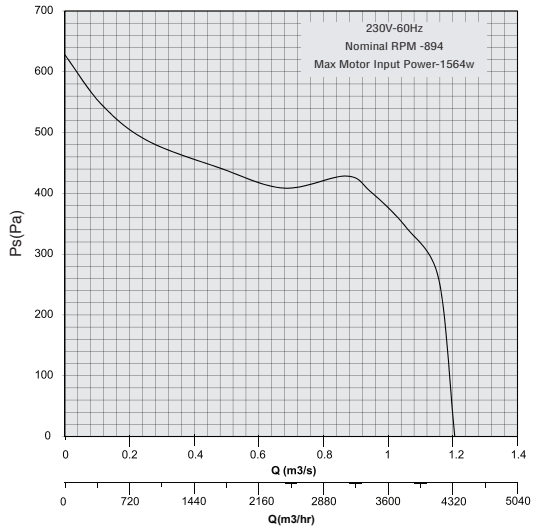

TWD 12/9 A6M

Q (Cmh)	Power (Watts)		A (amp)	V/Ph/F	IP/CL	uF	Reg	Power Module
	(P inp)	(P out)						
4320	1564	590	7.4	210-230/1/60	20/F	16	AC04	N A

Lp dB (A) at 3m (free Field)	Octave Band Frequency at max. airflow Hz (Lw,dB)							
	63	125	250	500	1K	2K	4K	8K
54	89	76	80	68	64	63	62	54

Lp-dBA levels are not licensed by AMCA International.

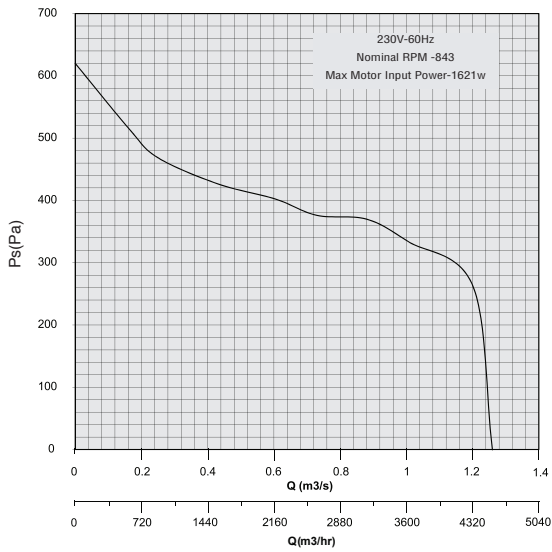

TWD 12/12 A6M

Q (Cmh)	Power (Watts)		A (amp)	V/Ph/F	IP/CL	uF	Reg	Power Module
	(P inp)	(P out)						
4536	1621	590	7.7	210-230/1/60	20/F	16	AC04	N A

Lp dB (A) at 3m (free Field)	Octave Band Frequency at max. airflow Hz (Lw,dB)							
	63	125	250	500	1K	2K	4K	8K
56	87	76	84	66	61	62	58	50

Lp-dBA levels are not licensed by AMCA International.

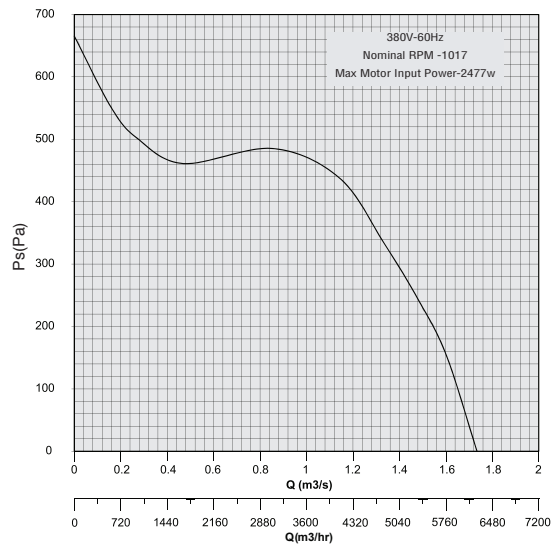

TWD 12/9 A6T

Q (Cmh)	Power (Watts)		A (amp)	V/Ph/F	IP/CL	uF	Reg	Power Module
	(P inp)	(P out)						
6192	2477	1100	4.5	380/3/60	20/F	16	AC02	P.M

Lp dB (A) at 3m (free Field)	Octave Band Frequency at max. airflow Hz (Lw,dB)							
	63	125	250	500	1K	2K	4K	8K
59	99	83	79	75	72	70	70	66

Lp-dBA levels are not licensed by AMCA International.

Values shown are for inlet Lwi sound power levels for Installation Type D: ducted inlet, ducted outlet. Ratings include the effects of duct end correction.

The sound power levels ratings shown are in decibels, referred to 10-12 watts, calculated per AMCA International Standard 301.

Speed (RPM) shown is nominal. Performance is based on actual speed of test. Performance ratings do not include the effects of appurtenances (accessories). Performance certified is for installation type D - Ducted inlet, ducted outlet.

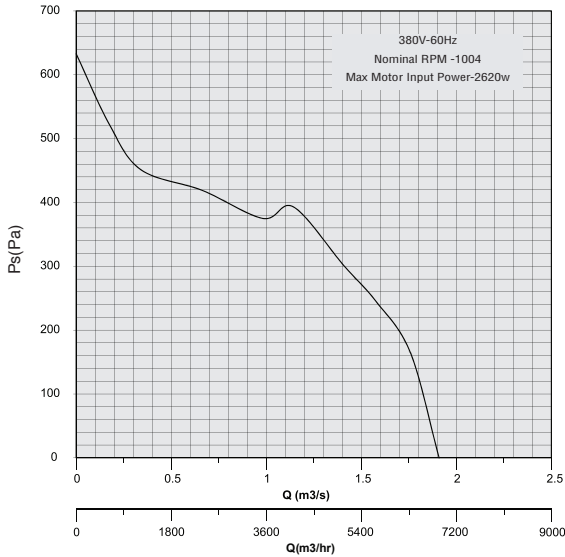

TWD 12/12 A6T

Q (Cmh)	Power (Watts)		A (amp)	V/Ph/F	IP/CL	uF	Reg	Power Module
	(P inp)	(P out)						
6840	2620	1100	4.7	380/3/60	20/F	8	AC02	P.M

Lp dB (A) at 3m (free Field)	Octave Band Frequency at max.airflow Hz (Lw,dB)							
	63	125	250	500	1K	2K	4K	8K
62	96	84	80	84	72	70	69	64

Lp-dBA levels are not licensed by AMCA International.

FAN CONTROLLER MODEL: AC-02/04

Twin fan controller model AC-02/04 is designed using microcontroller technology & capable to operate two fans as per the programmed time sequence. This controller has an in-built diagnostic and controlling function & few key features as listed below:

FEATURES:

- Controller can be configured to either Auto or Manual mode
- Auto Mode is further divided into Air sense mode or Current sense mode or Air-current sense mode.
- Manual mode is also divided into Air sense or Current sense mode or Air-current sense mode.
- Programmable options with 1 to 12 hours “change over” cycle along with on-line programming features.
- Inbuilt plug and play speed regulation option.
- Seven segment display and LED indicators for better programming and fault monitoring features to enhance the user experience.
- Building Management system (BMS) status indication through volt free relay contacts for monitoring. (ON, TRIP, AUTO)
- Designed to operate directly on 220V @ 12 amps, single phase motor.
- Added features with “over current tripping level” by Low and High level cut off.
- 220V AC rated controller, suitable for 50 or 60Hz line frequency.
- In built Fuse Protection as standard features.
- Actual size: 180 X 180 X 75 mm.
- Weight: 885 gm.





Maico Ventilation Pvt. LTD
Plot I-02, Part-1, Khed City, Rajgurunagar, Pune – 410505, Maharashtra, India
www.maico.co.in
enquiry@maico.co.in

MI-TWD-10-2018

FEATURES AND TECHNICAL DATA CAN VARY WITHOUT PRIOR NOTICE WITHOUT MODIFYING THE MAIN FUNCTIONAL PARAMETERS OF THE PRODUCTS. ALL TRADEMARKS MENTIONED ARE THE PROPERTY OF MAICO. ALL RIGHTS RESERVED.