

 AIR COMFORT

 FIRE SAFETY

# JMC AEROFOIL

PERFORMANCE CATALOGUE

» WE BRING BETTER AIR TO LIFE

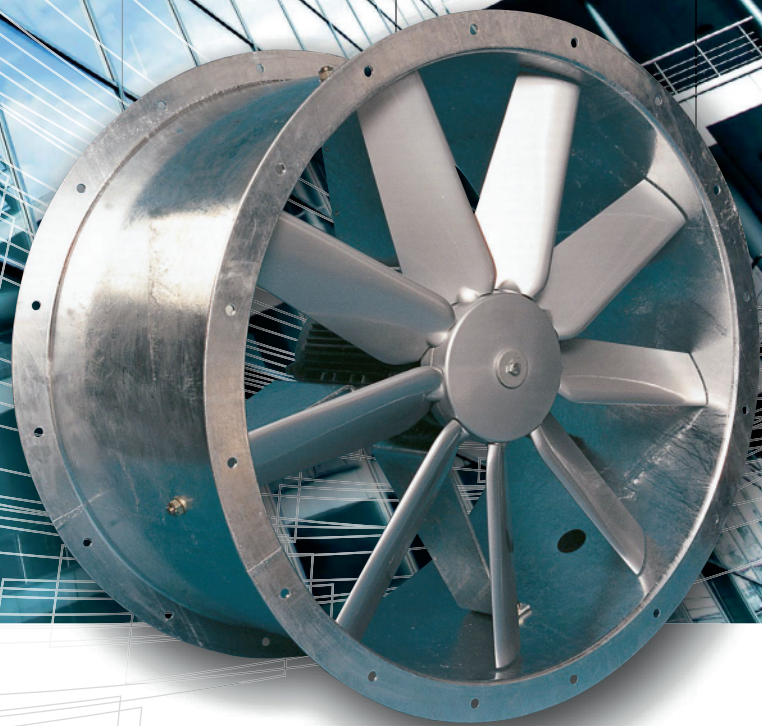

**Certified Model**  
JMC 71, 80, 90, 160

## JMC AEROFOIL - DESCRIPTION

### Features

- 710 - 1600 mm diameter
- Volumes up to 186,500 m<sup>3</sup>/h (51.8 m<sup>3</sup>/s)
- Static pressures up to 2400 Pa
- Fans tested to AMCA300
- High energy efficiency
- Low installed noise levels
- Motor protection IP55
- Larger sizes available please enquire for more information

### Electrical Supply

- 380-420V/50-60Hz/3 φ

### Temperature Range

- -40°C to 50°C as standard
- 50°C to 70°C must be run at full speed only

### Sizes

710, 800, 900, and 1600 mm.

### Impellers

A unique high efficiency aerofoil section blade with a purposely smoothed hub and clamp plate for adjustable pitch angle availability.

FlaktGroup impellers are all high pressure die cast to offer thin aerofoil sections for low generation of noise. Every cast aluminium component is X-ray examined using Real Time Radiography inspection prior to assembly. The maximum pitch angles shown allow for speed control by frequency inverter (3ph only).



### Motors

All motors are totally enclosed air stream rated class F insulation. Constructed from aluminium or cast iron as standard with special 'T' slot, pad or foot mounted fixings. Single speed motors are suitable for speed control by voltage regulation where indicated. Three phase motors are suitable or use with frequency inverters, suitable for turn down to 20% of maximum speed. Two speed motors are available on request. Suitable for horizontal or vertical shaft operation. Supplied IP55, with removable drain plugs.



Sealed for life bearings lubricated with wide temperature range grease. These motors are suitable for inverter speed control down to 20% of full speed and where within scope incorporate IE2 compliant motors.

### Casings

JMC Aerofoil fans are available in either a long cased form, complete with an externally mounted pre-wired electrical terminal box, or short cased for duct or plate installation. Casings are spun from sheet steel with integral pre-drilled and radiused inlet flanges. The galvanised finish gives a high resistance to corrosion and is ideal for external as well as internal use.

### Product Code

71JMC/20/4/6/36

- 71 - denotes the fan impeller diameter in centimetres
- JMC - denotes fan type
- 20 - denotes impeller hub diameter in centimetres
- 4 - denotes a nominal 4 pole speed
- 6 - denotes the number of blades
- 36 - denotes the pitch angle for the required duty

### Accessories Available (on request)

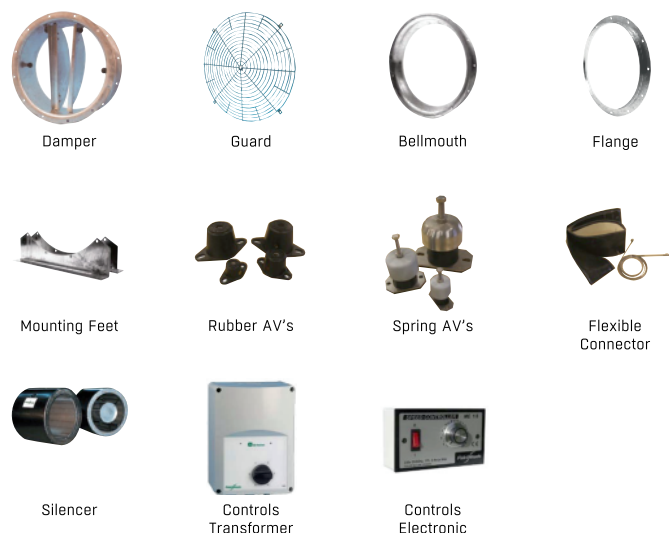

## HOW TO SPECIFY A FAN

### Specifying The Fan

Having chosen the fan most suitable for your individual application.

#### Please specify as follows:-

1. The fan shall be manufactured by **FlaktGroup** model type JMC Aerofoil long or short cased (L or S-type).
2. Motors, squirrel cage type, insulated to class F, bearings lubricated with wide temperature grease, keyed shaft. To comply with BS5000 Pt 99 and IEC 34-1. Weatherproof to IP55. (Overheat protection provided on most single phase motors).
3. Impellers, precision die cast aluminium hub and clamp-plate, with equally spaced, fully adjustable precision die cast Aerofoil section blades. All rotating aluminium components to be X-ray examined prior to machining to assure quality of castings.
4. Casings, either a long cased form complete with an externally mounted pre-wired electrical terminal box, or short cased for duct or plate installation. Casings are spun from sheet steel with integral pre-drilled flanges, fully welded seams and hot-dipped galvanised after manufacture for excellent durability.
5. Mounting Arms, manufactured from mild steel hot dipped galvanised after manufacture.
6. Performance shall be independantly approved by AMCA, and established in accordance with ISO5801:1997 installation category D, method of testing air performance and AMCA 300 method of noise testing.
7. Ancillaries as required.

### Ordering The Fan

After identifying the best fan for your application please order as follows:-

1. Fan type: JMC Aerofoil Long cased (L-type), or Short Cased (S-type) Form A or Form B.
2. Fan Code:  
eg: 71JMC/20/8/6/24  
where: 71 denotes the Fan impeller diameter in centimetres.  
JMC denotes Fan Type.  
/20 denotes impeller hub diameter in centimetres.  
/8 denotes a nominal 8 pole speed.  
/6 denotes the number of blades.  
/24 denotes the Pitch Angle for the required duty.
3. Quantity required.
4. Duty required at standard air and temperature e.g. 1.60 m<sup>3</sup>/s @ 50 Pa.
5. Motor. eg: 100L
6. Electrical Supply:  
220-240 V / 50 Hz / 1ϕ  
380-420 V / 50 Hz / 3ϕ
7. Ancillary items required.  
Mounting Feet  
Impeller and Motor Side Guards  
Silencers with or without pod  
Speed Controller (electronic or auto-transformer) or 2 speeds with type MDS3.10  
Air Operated Dampers  
Matching Flanges  
Bellmouth Inlets  
Flexible Connectors  
Vibration Isolators



FlaktGroup India Pvt. Ltd. certifies that the 71JMC, 80JMC, 90JMC, 160 JMC series shown herein are licenced to bear the AMCA seal. The ratings shown are based on tests and procedures performed in accordance with AMCA publication 211 and AMCA Publication 311 and comply with the requirements of the AMCA Certified Rating Program.



## GUIDE TO FAN SELECTION SELECTION EXAMPLE - TOTAL PRESSURE

There are two principle methods of expressing the pressure requirements, namely,  $P_F$  (Total) and  $P_{SF}$  (Static) pressure. The two types of pressure are related:

$$P_F = P_{SF} + P_{dF} \quad PF = \text{Fan Total pressure}$$

$$P_{SF} = \text{Fan Static pressure}$$

$$P_{dF} = \text{Fan Dynamic pressure}$$

The international convention considers fan performance in terms of total pressure, but there is also established practice relating to the use of static pressure. For this reason Fläkt Woods selection charts are laid out on a total pressure major scale and include a secondary grid for static pressure. The facility to display fan performance in terms of static pressure is necessary in order to avoid total pressure fan selections being made based on static pressure system requirements.

The guide selections are made for either total or static pressures of 100Pa. The resulting selections are quite different and highlight the consequences of selecting static pressure from charts that only display performance in terms of total pressure.

### Procedure - Total Pressure (PF)

#### 1. Guide to Chart Numbers of Possible Selections

The charts are arranged in order of fan diameter, starting at 315 mm, up to 1600 mm diameter, and in order of fan speed for each diameter, 3,5,6,9 & 12 bladed fan impellers as available.

**NOTE:** The chart numbers lead to a variety of fan sizes, impeller configurations and speeds. The fan selected from the alternatives available will depend on the most critical factor for the particular application - Volume Flow and Pressure required, Size, Power Consumption, Sound Level or First Cost.

#### 2. Required Duty

Establish the volume flow and total pressure required of an individual fan at Standard Air (1.2 kg/m<sup>3</sup>).

#### 3. Selection on Individual Fan Charts

The data provided on each performance chart is specifically for ducted - Type D (ducted) installations for both long or short cased (S-type) fans.

Providing reasonable Type D conditions are maintained in installation of the fans, no additional factors to volume flow or pressure need be incorporated for a suitable selection to be made.

Plot the duty on the selected fan charts to establish blade angle, sound level, absorbed power, motor size and rating, for the particular arrangement.

- Ⓓ - Duty Point Required - @ Standard Air (1.2 kg/m<sup>3</sup>).  
0.55 m<sup>3</sup>/s @ 100Pa total pressure.
- ① - Volume Flow = 0.55 m<sup>3</sup>/s
- ② - Fan Total Pressure = 100 Pa
- ③ - Overall inlet Sound Power Level = 72 LW (interpolated from surrounding levels).

- ④ - Pitch Angle required to achieve Duty Point = 28°
- ⑤ - Corrections to overall Sound Power Level for 28° Pitch Angle. (Operating Point is Below shaded area)

|             |       | 63 | 125 | 250 | 500 | 1K | 2K | 4K | 8K |    |
|-------------|-------|----|-----|-----|-----|----|----|----|----|----|
| Sound Power | Inlet | 65 | 67  | 64  | 65  | 60 | 54 | 51 | 45 | Lw |
|             | Level | 67 | 70  | 65  | 65  | 60 | 54 | 52 | 46 | Lw |

- ⑥ - Absorbed Power @ Duty Point @ 28°  
Pitch Angle = 0.09 kW  
Suitable Motor for fixed speed application, 3 phase supply, from motor schedules.

### Speed Regulatable Versions

If a speed regulatable version is required, (or Delta/Star reconnect on 3 phase versions) the duty volume flow required should be multiplied by 1.05 prior to fan selection being made



# Fan Code: 71JMC/20/8/3/...

## 710 mm 680 rev/min 3 Blades 50 Hz



**FEG80**

**Performance Data ISO 5801:**

Performance certified is for installation type D-Ducted inlet, Ducted outlet. Performance ratings do not include the effects of appurtenances (accessories).

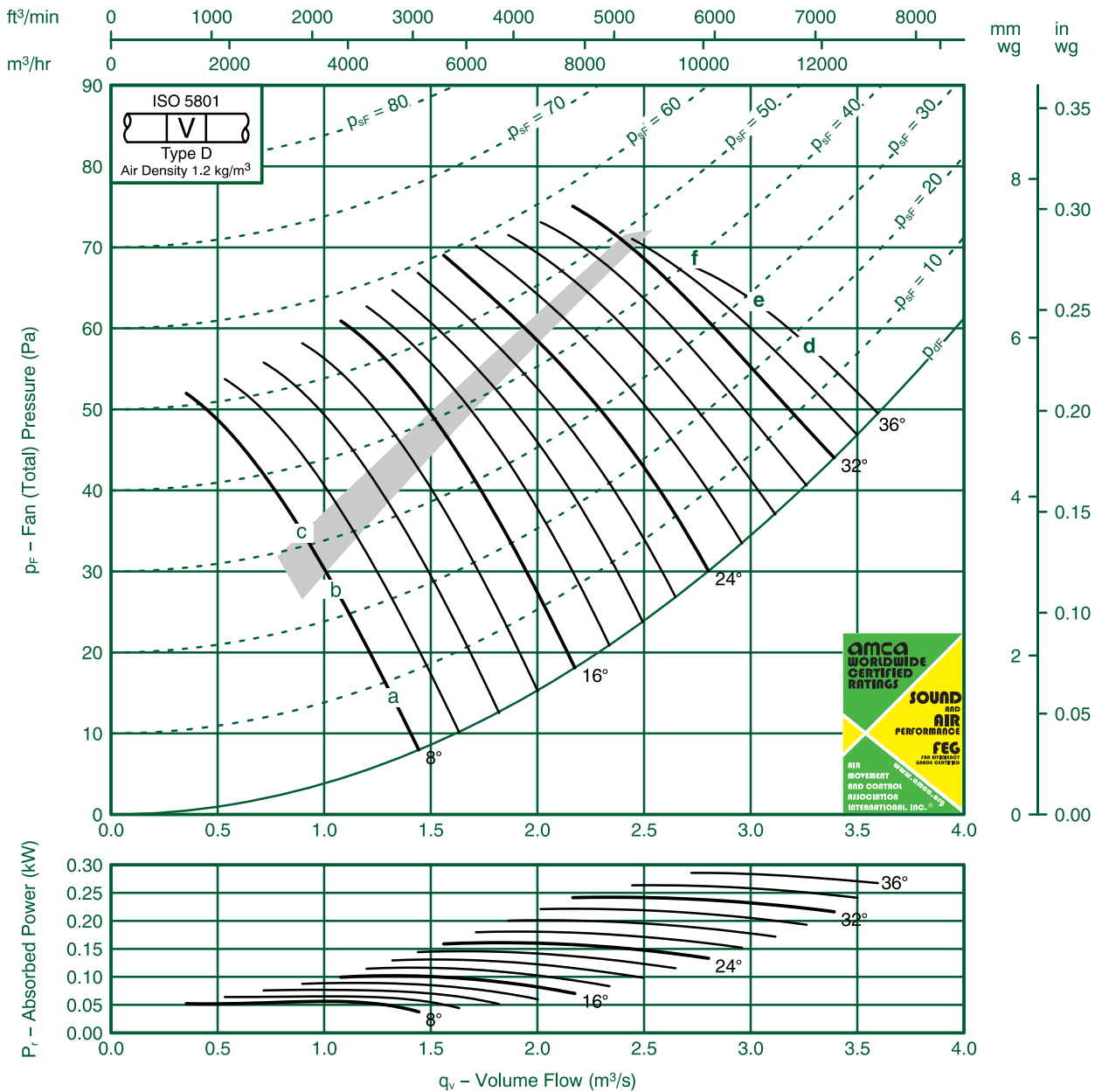

| Ref | FULL OCTAVE BAND FREQUENCY |     |     |     |      |      |      |      | LwA |
|-----|----------------------------|-----|-----|-----|------|------|------|------|-----|
|     | 63                         | 125 | 250 | 500 | 1000 | 2000 | 4000 | 8000 |     |
| a   | 61                         | 62  | 66  | 62  | 59   | 58   | 52   | 46   | 65  |
| b   | 61                         | 63  | 69  | 66  | 60   | 56   | 51   | 46   | 67  |
| c   | 63                         | 68  | 75  | 69  | 61   | 55   | 49   | 43   | 70  |
| d   | 72                         | 70  | 76  | 75  | 70   | 66   | 64   | 62   | 76  |
| e   | 72                         | 70  | 76  | 75  | 69   | 65   | 63   | 60   | 76  |
| f   | 73                         | 70  | 76  | 76  | 69   | 64   | 61   | 58   | 76  |

FlaktGroup India Pvt. Ltd. certifies that the 71JMC/20/8/3 series shown herein are Licensed to bear the AMCA Seal.

The ratings shown are based on tests and procedures performed in accordance with AMCA Publication 211 and AMCA Publication 311 and comply with the requirements of the AMCA Certified Ratings Program.

Performance certified is for Installation type D: Ducted Inlet- Ducted Outlet. Performance ratings do not include the effects of appurtenances (accessories)

The Sound Power Level ratings shown are in decibels, referred to  $10^{-12}$  watts, calculated per AMCA International Standard 301. Values shown are for inlet LWi and LWiA sound power levels for Installation type D: Ducted Inlet-Ducted Outlet. Ratings include the effects of duct end correction.

The A-weighted sound ratings shown have been calculated per AMCA International Standard 301.



# Fan Code: 71JMC/20/8/6/...

## 710 mm 680 rev/min 6 Blades 50 Hz



### Performance Data ISO 5801:

Performance certified is for installation type D-Ducted inlet, Ducted outlet. Performance ratings do not include the effects of appurtenances (accessories).

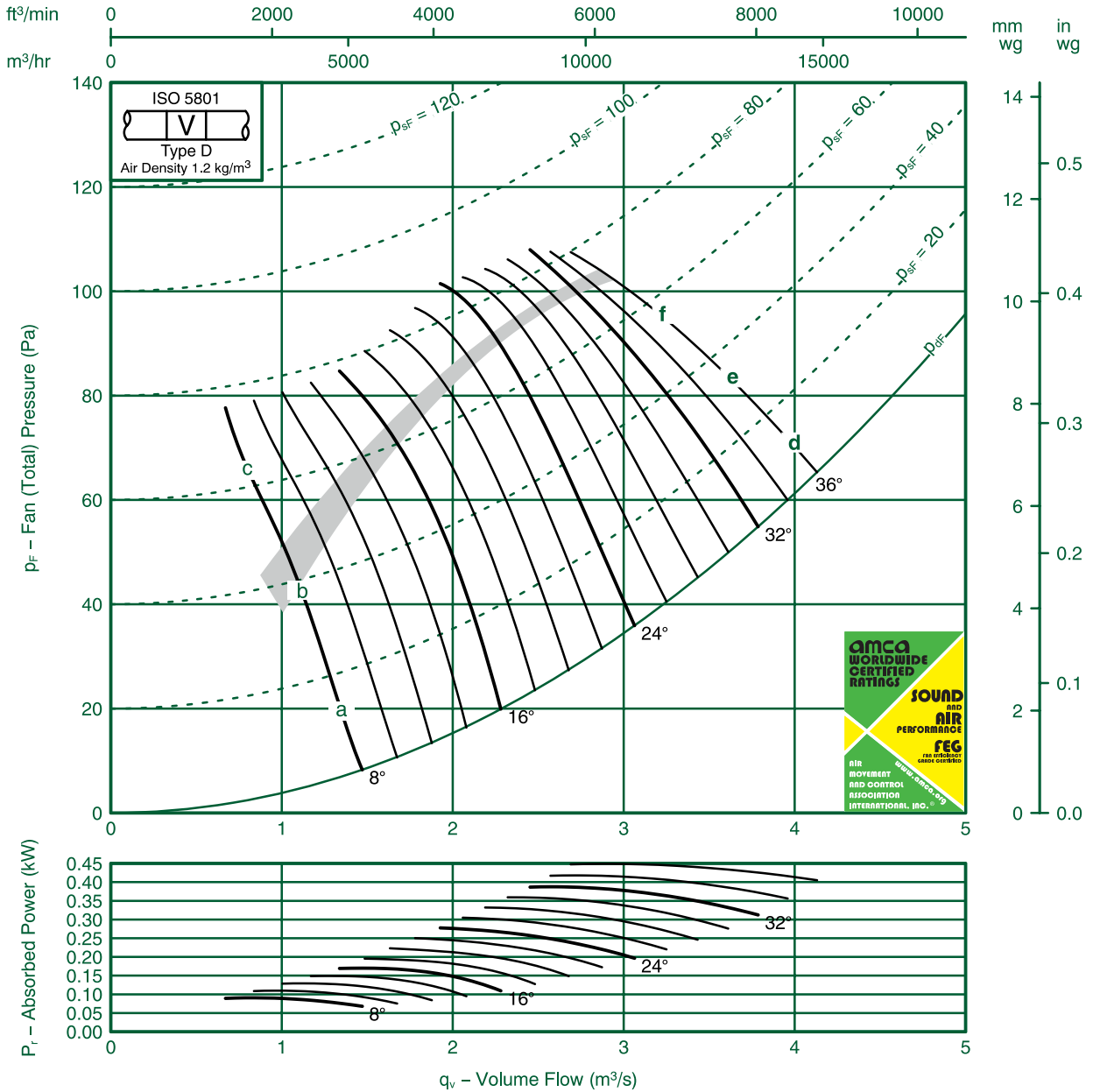

| Ref | FULL OCTAVE BAND FREQUENCY |        |        |        |       |       |       |       | LWA |
|-----|----------------------------|--------|--------|--------|-------|-------|-------|-------|-----|
|     | 63 Hz                      | 125 Hz | 250 Hz | 500 Hz | 1K Hz | 2K Hz | 4K Hz | 8K Hz |     |
| a   | 69                         | 69     | 71     | 71     | 66    | 61    | 56    | 51    | 72  |
| b   | 71                         | 72     | 76     | 73     | 67    | 61    | 54    | 48    | 74  |
| c   | 84                         | 82     | 75     | 70     | 65    | 59    | 52    | 46    | 73  |
| d   | 75                         | 71     | 78     | 76     | 68    | 65    | 63    | 61    | 76  |
| e   | 74                         | 71     | 77     | 78     | 69    | 66    | 64    | 61    | 78  |
| f   | 74                         | 71     | 77     | 79     | 70    | 66    | 64    | 62    | 78  |

FlaktGroup India Pvt. Ltd. certifies that the 71JMC/20/8/6 series shown herein are Licensed to bear the AMCA Seal.

The ratings shown are based on tests and procedures performed in accordance with AMCA Publication 211 and AMCA Publication 311 and comply with the requirements of the AMCA Certified Ratings Program.

Performance certified is for Installation type D: Ducted Inlet- Ducted Outlet. Performance ratings do not include the effects of appurtenances (accessories)

The Sound Power Level ratings shown are in decibels, referred to 10<sup>-12</sup> watts, calculated per AMCA International Standard 301. Values shown are for inlet LWi and LWiA sound power levels for Installation type D: Ducted Inlet-Ducted Outlet. Ratings include the effects of duct end correction.

The A-weighted sound ratings shown have been calculated per AMCA International Standard 301.



# Fan Code: 71JMC/25/8/9/...

## 710 mm 695 rev/min 9 Blades 50 Hz



**FEG71**

**Performance Data ISO 5801:**

Performance certified is for installation type D-Ducted inlet, Ducted outlet. Performance ratings do not include the effects of appurtenances (accessories).

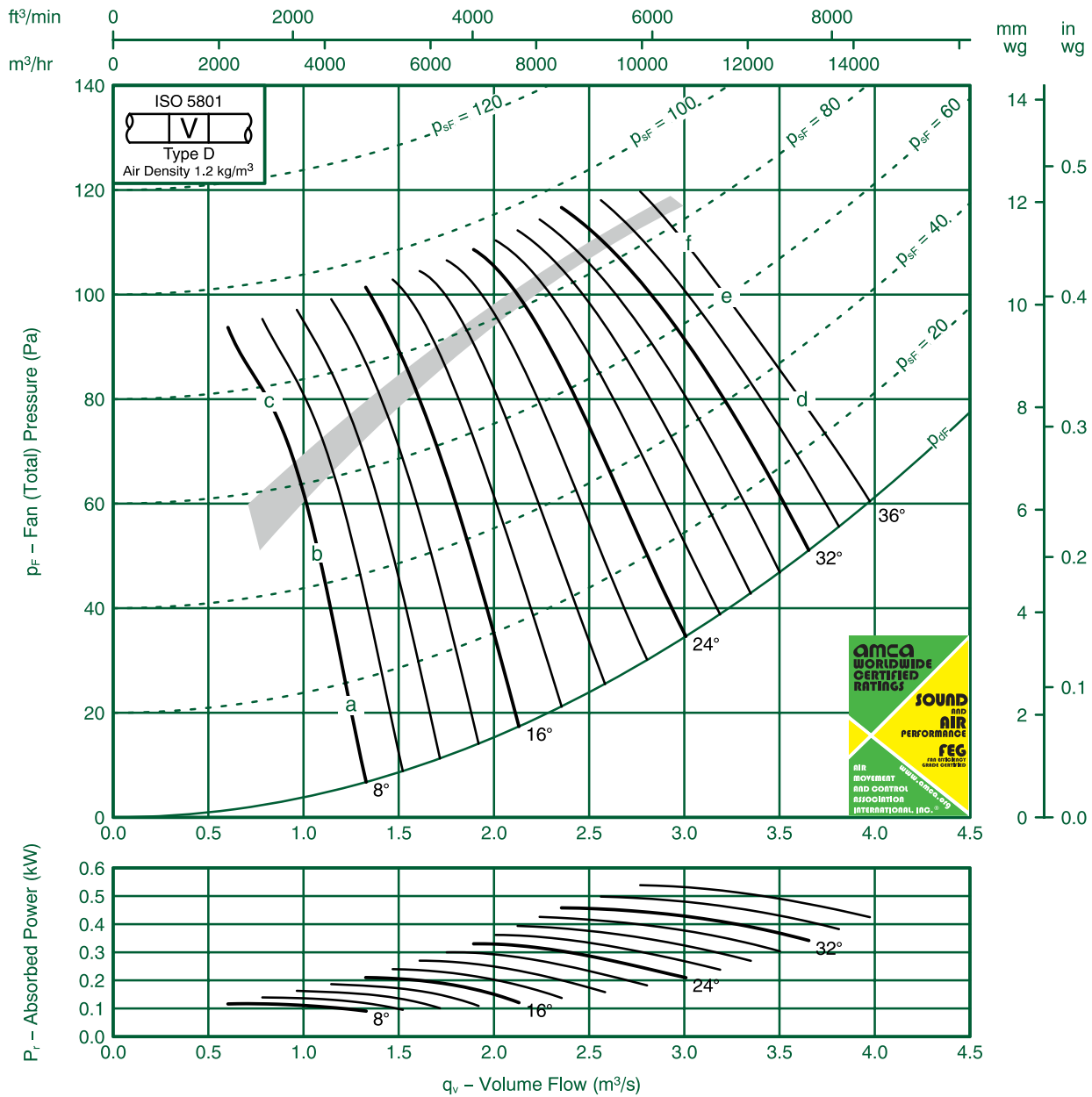

| Ref | FULL OCTAVE BAND FREQUENCY |        |        |        |       |       |       |       | LWA |
|-----|----------------------------|--------|--------|--------|-------|-------|-------|-------|-----|
|     | 63 Hz                      | 125 Hz | 250 Hz | 500 Hz | 1K Hz | 2K Hz | 4K Hz | 8K Hz |     |
| a   | 65                         | 65     | 69     | 67     | 64    | 63    | 54    | 46    | 70  |
| b   | 72                         | 78     | 76     | 74     | 67    | 61    | 54    | 47    | 74  |
| c   | 84                         | 77     | 73     | 68     | 64    | 59    | 54    | 49    | 71  |
| d   | 72                         | 74     | 75     | 71     | 68    | 66    | 65    | 64    | 75  |
| e   | 72                         | 73     | 75     | 71     | 68    | 66    | 65    | 65    | 75  |
| f   | 73                         | 74     | 74     | 72     | 69    | 67    | 66    | 65    | 75  |

FlaktGroup India Pvt. Ltd. certifies that the 71JMC/25/8/9 series shown herein are Licensed to bear the AMCA Seal.

The ratings shown are based on tests and procedures performed in accordance with AMCA Publication 211 and AMCA Publication 311 and comply with the requirements of the AMCA Certified Ratings Program.

Performance certified is for Installation type D: Ducted Inlet- Ducted Outlet. Performance ratings do not include the effects of appurtenances (accessories)

The Sound Power Level ratings shown are in decibels, referred to  $10^{-12}$  watts, calculated per AMCA International Standard 301. Values shown are for inlet LWi and LWiA sound power levels for Installation type D: Ducted Inlet-Ducted Outlet. Ratings include the effects of duct end correction.

The A-weighted sound ratings shown have been calculated per AMCA International Standard 301.



# Fan Code: 71JMC/20/6/3/...

## 710 mm 900 rev/min 3 Blades 50 Hz



### Performance Data ISO 5801:

Performance certified is for installation type D-Ducted inlet, Ducted outlet. Performance ratings do not include the effects of appurtenances (accessories).

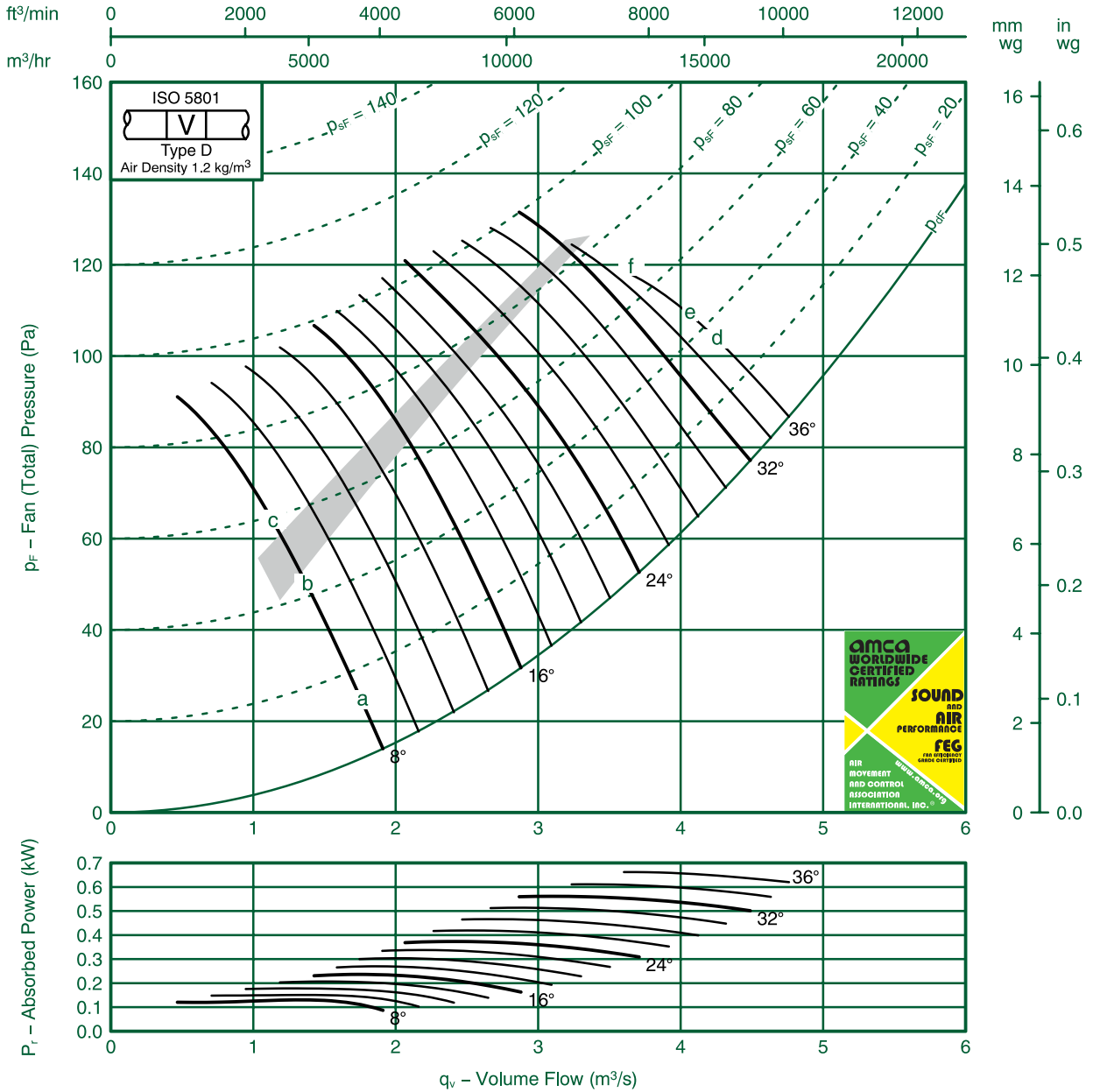

| FULL OCTAVE BAND FREQUENCY |    |     |     |     |      |      |      |      |     |
|----------------------------|----|-----|-----|-----|------|------|------|------|-----|
| Ref                        | 63 | 125 | 250 | 500 | 1000 | 2000 | 4000 | 8000 | LwA |
| a                          | 68 | 67  | 71  | 70  | 66   | 65   | 60   | 54   | 72  |
| b                          | 69 | 68  | 73  | 74  | 68   | 64   | 59   | 54   | 74  |
| c                          | 70 | 71  | 79  | 78  | 70   | 63   | 57   | 51   | 77  |
| d                          | 82 | 76  | 80  | 82  | 78   | 73   | 70   | 68   | 83  |
| e                          | 83 | 76  | 80  | 82  | 77   | 72   | 70   | 67   | 83  |
| f                          | 84 | 77  | 80  | 82  | 78   | 72   | 69   | 66   | 83  |

FlaktGroup India Pvt. Ltd. certifies that the 71JMC/20/6/3 series shown herein are Licensed to bear the AMCA Seal.

The ratings shown are based on tests and procedures performed in accordance with AMCA Publication 211 and AMCA Publication 311 and comply with the requirements of the AMCA Certified Ratings Program.

Performance certified is for Installation type D: Ducted Inlet- Ducted Outlet. Performance ratings do not include the effects of appurtenances (accessories)

The Sound Power Level ratings shown are in decibels, referred to  $10^{-12}$  watts, calculated per AMCA International Standard 301. Values shown are for inlet LWi and LWiA sound power levels for Installation type D: Ducted Inlet-Ducted Outlet. Ratings include the effects of duct end correction.

The A-weighted sound ratings shown have been calculated per AMCA International Standard 301.





# Fan Code: 71JMC/20/6/6/...

## 710 mm 900 rev/min 6 Blades 50 Hz



**FEG80**

**Performance Data ISO 5801:**

Performance certified is for installation type D-Ducted inlet, Ducted outlet. Performance ratings do not include the effects of appurtenances (accessories).

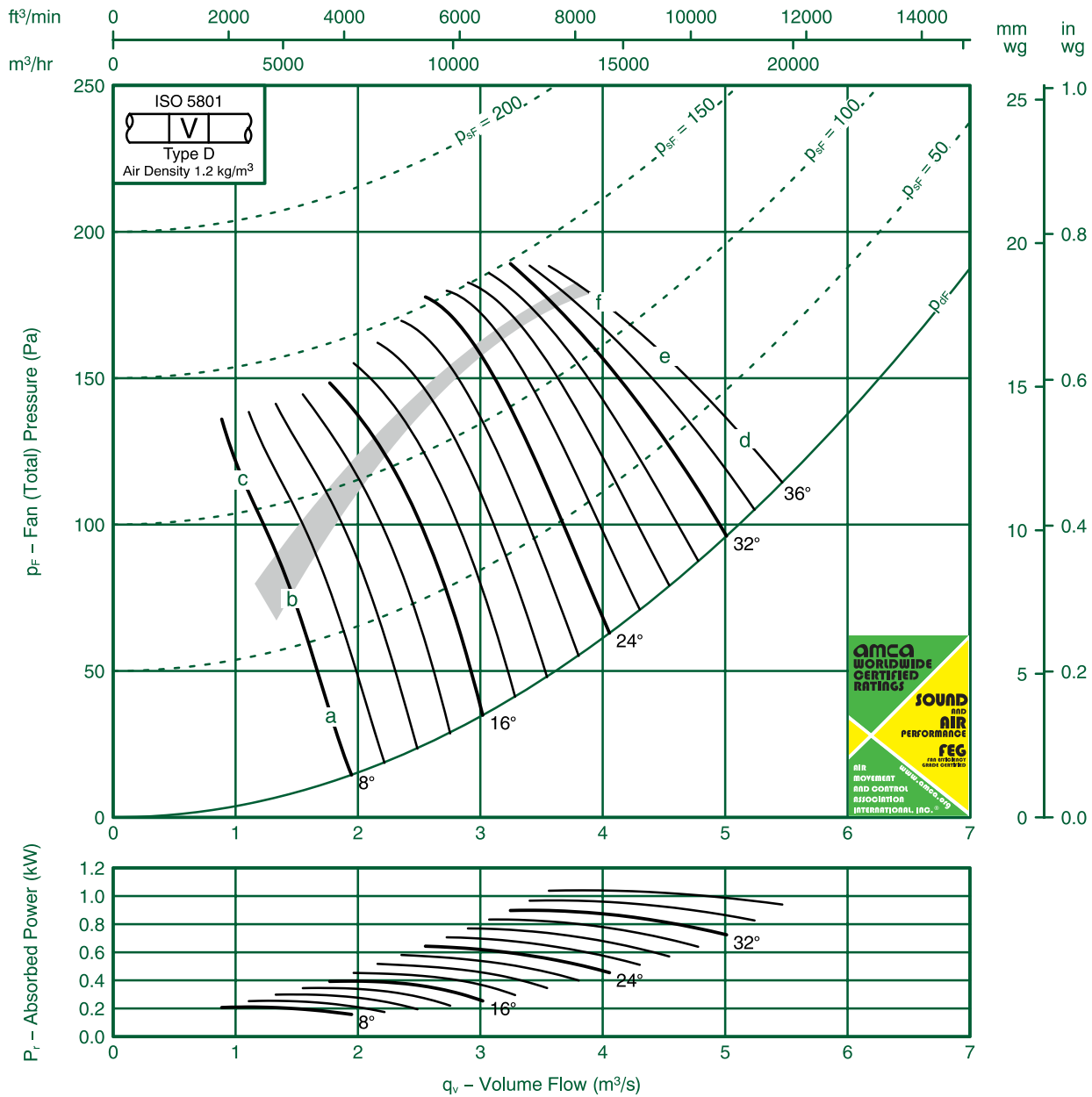

| Ref | FULL OCTAVE BAND FREQUENCY |        |        |        |       |       |       |       | LWA |
|-----|----------------------------|--------|--------|--------|-------|-------|-------|-------|-----|
|     | 63 Hz                      | 125 Hz | 250 Hz | 500 Hz | 1K Hz | 2K Hz | 4K Hz | 8K Hz |     |
| a   | 75                         | 75     | 77     | 78     | 75    | 69    | 64    | 59    | 79  |
| b   | 77                         | 77     | 81     | 81     | 76    | 69    | 63    | 57    | 81  |
| c   | 91                         | 91     | 84     | 78     | 73    | 67    | 61    | 54    | 81  |
| d   | 83                         | 81     | 82     | 83     | 77    | 73    | 70    | 68    | 84  |
| e   | 82                         | 80     | 81     | 85     | 79    | 73    | 71    | 68    | 85  |
| f   | 85                         | 84     | 83     | 85     | 79    | 74    | 71    | 68    | 85  |

FlaktGroup India Pvt. Ltd. certifies that the 71JMC/20/6/6 series shown herein are Licensed to bear the AMCA Seal.

The ratings shown are based on tests and procedures performed in accordance with AMCA Publication 211 and AMCA Publication 311 and comply with the requirements of the AMCA Certified Ratings Program.

Performance certified is for Installation type D: Ducted Inlet- Ducted Outlet. Performance ratings do not include the effects of appurtenances (accessories)

The Sound Power Level ratings shown are in decibels, referred to  $10^{-12}$  watts, calculated per AMCA International Standard 301. Values shown are for inlet LWi and LWiA sound power levels for Installation type D: Ducted Inlet-Ducted Outlet. Ratings include the effects of duct end correction.

The A-weighted sound ratings shown have been calculated per AMCA International Standard 301.



# Fan Code: 71JMC/25/6/9/...

## 710 mm 935 rev/min 9 Blades 50 Hz



**FEG71**

### Performance Data ISO 5801:

Performance certified is for installation type D-Ducted inlet, Ducted outlet. Performance ratings do not include the effects of appurtenances (accessories).

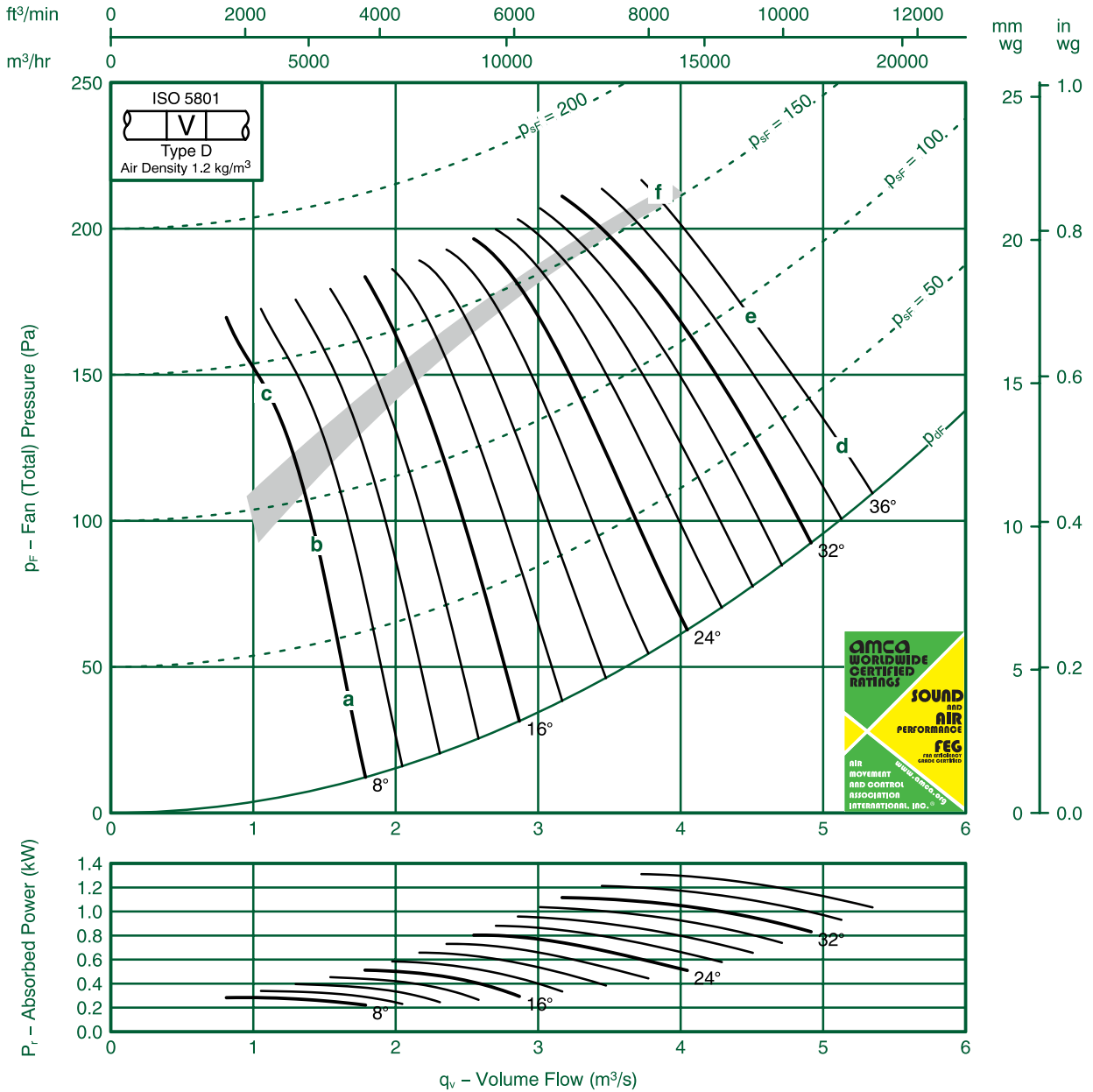

| Ref | FULL OCTAVE BAND FREQUENCY |        |        |        |       |       |       |       | LWA |
|-----|----------------------------|--------|--------|--------|-------|-------|-------|-------|-----|
|     | 63 Hz                      | 125 Hz | 250 Hz | 500 Hz | 1K Hz | 2K Hz | 4K Hz | 8K Hz |     |
| a   | 74                         | 72     | 74     | 74     | 72    | 70    | 65    | 57    | 77  |
| b   | 81                         | 83     | 82     | 80     | 76    | 70    | 64    | 57    | 81  |
| c   | 90                         | 87     | 81     | 76     | 72    | 67    | 62    | 57    | 79  |
| d   | 83                         | 81     | 81     | 79     | 75    | 73    | 72    | 70    | 82  |
| e   | 83                         | 80     | 81     | 79     | 76    | 73    | 72    | 71    | 81  |
| f   | 83                         | 80     | 80     | 79     | 77    | 74    | 73    | 72    | 83  |

FlaktGroup India Pvt. Ltd. certifies that the 71JMC/25/6/9 series shown herein are Licensed to bear the AMCA Seal.

The ratings shown are based on tests and procedures performed in accordance with AMCA Publication 211 and AMCA Publication 311 and comply with the requirements of the AMCA Certified Ratings Program.

Performance certified is for Installation type D: Ducted Inlet- Ducted Outlet. Performance ratings do not include the effects of appurtenances (accessories)

The Sound Power Level ratings shown are in decibels, referred to  $10^{-12}$  watts, calculated per AMCA International Standard 301. Values shown are for inlet LWi and LWiA sound power levels for Installation type D: Ducted Inlet-Ducted Outlet. Ratings include the effects of duct end correction.

The A-weighted sound ratings shown have been calculated per AMCA International Standard 301.



# Fan Code: 71JMC/20/4/3/...

## 710 mm 1440 rev/min 3 Blades 50 Hz



**FEG80**

**Performance Data ISO 5801:**

Performance certified is for installation type D-Ducted inlet, Ducted outlet. Performance ratings do not include the effects of appurtenances (accessories).

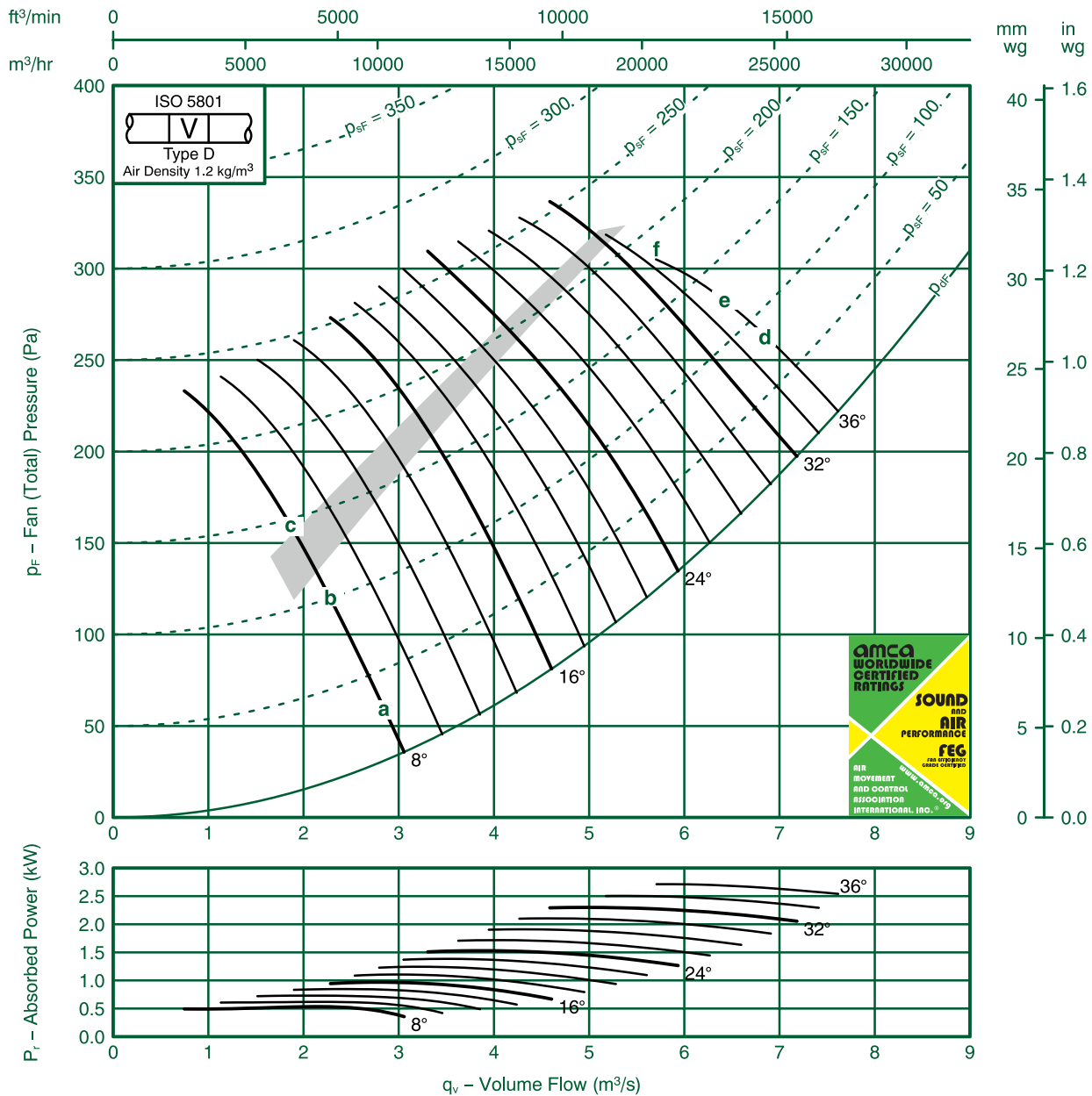

| Ref | FULL OCTAVE BAND FREQUENCY |        |        |        |       |       |       |       | LwA |
|-----|----------------------------|--------|--------|--------|-------|-------|-------|-------|-----|
|     | 63 Hz                      | 125 Hz | 250 Hz | 500 Hz | 1K Hz | 2K Hz | 4K Hz | 8K Hz |     |
| a   | 82                         | 77     | 78     | 82     | 79    | 76    | 74    | 69    | 84  |
| b   | 85                         | 77     | 79     | 85     | 83    | 76    | 73    | 68    | 87  |
| c   | 86                         | 78     | 83     | 92     | 86    | 78    | 71    | 66    | 91  |
| d   | 103                        | 88     | 86     | 92     | 92    | 86    | 82    | 80    | 95  |
| e   | 104                        | 89     | 86     | 92     | 92    | 86    | 81    | 79    | 95  |
| f   | 104                        | 90     | 86     | 92     | 92    | 86    | 81    | 78    | 95  |

FlaktGroup India Pvt. Ltd. certifies that the 71JMC/20/4/3 series shown herein are Licensed to bear the AMCA Seal.

The ratings shown are based on tests and procedures performed in accordance with AMCA Publication 211 and AMCA Publication 311 and comply with the requirements of the AMCA Certified Ratings Program.

Performance certified is for Installation type D: Ducted Inlet- Ducted Outlet. Performance ratings do not include the effects of appurtenances (accessories)

The Sound Power Level ratings shown are in decibels, referred to  $10^{-12}$  watts, calculated per AMCA International Standard 301. Values shown are for inlet LWi and LWiA sound power levels for Installation type D: Ducted Inlet-Ducted Outlet. Ratings include the effects of duct end correction.

The A-weighted sound ratings shown have been calculated per AMCA International Standard 301.



# Fan Code: 71JMC/20/4/6/...

## 710 mm 1440 rev/min 6 Blades 50 Hz



### Performance Data ISO 5801:

Performance certified is for installation type D-Ducted inlet, Ducted outlet. Performance ratings do not include the effects of appurtenances (accessories).

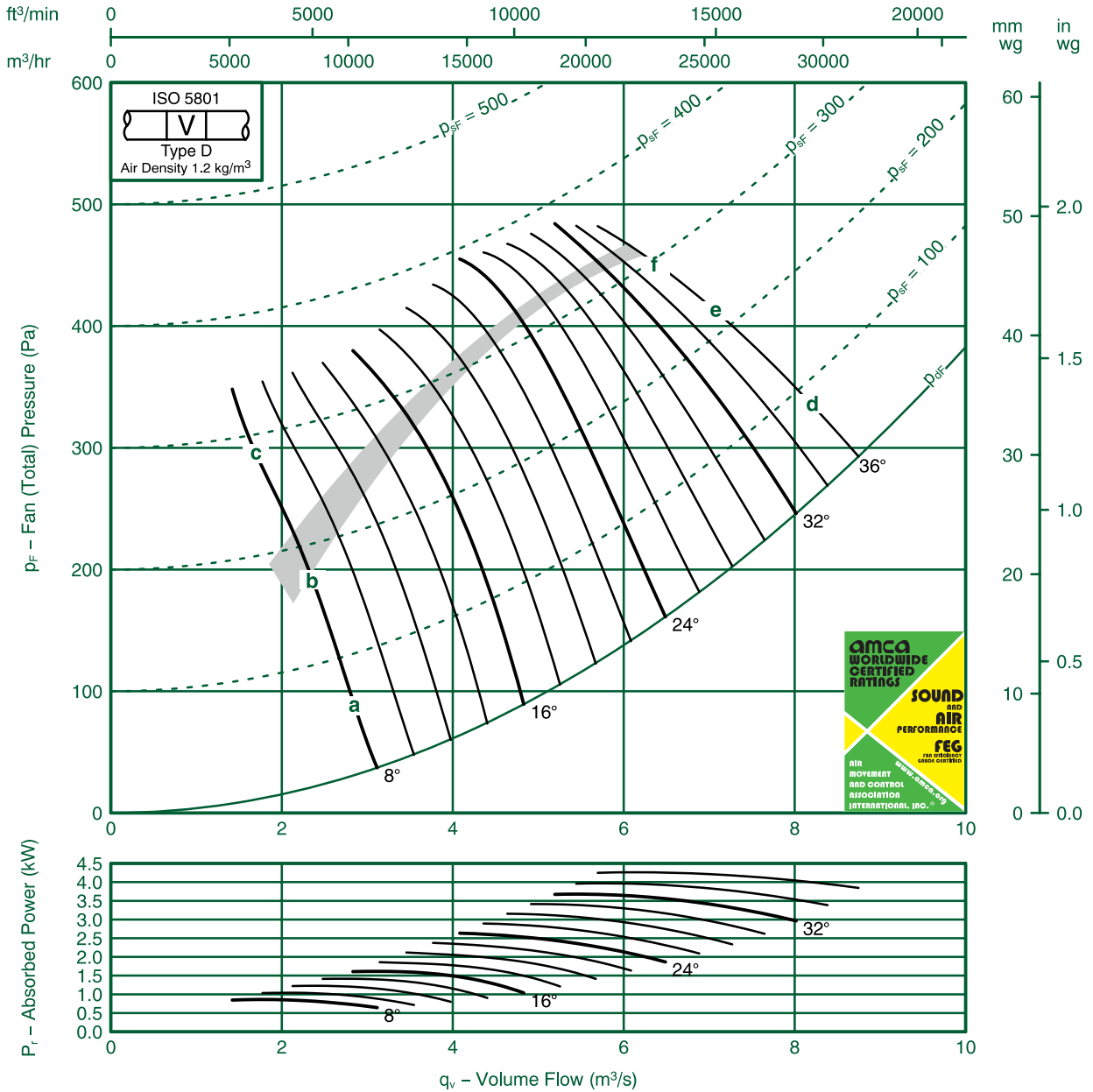

| Ref | FULL OCTAVE BAND FREQUENCY |        |        |        |       |       |       |       | LWA |
|-----|----------------------------|--------|--------|--------|-------|-------|-------|-------|-----|
|     | 63 Hz                      | 125 Hz | 250 Hz | 500 Hz | 1K Hz | 2K Hz | 4K Hz | 8K Hz |     |
| a   | 83                         | 85     | 85     | 88     | 87    | 83    | 78    | 73    | 91  |
| b   | 82                         | 87     | 87     | 90     | 89    | 83    | 78    | 72    | 93  |
| c   | 96                         | 99     | 98     | 92     | 87    | 82    | 76    | 69    | 94  |
| d   | 97                         | 91     | 87     | 94     | 93    | 85    | 82    | 79    | 96  |
| e   | 98                         | 90     | 87     | 93     | 95    | 86    | 82    | 80    | 97  |
| f   | 99                         | 94     | 90     | 94     | 95    | 87    | 83    | 80    | 98  |

FlaktGroup India Pvt. Ltd. certifies that the 71JMC/20/4/6 series shown herein are Licensed to bear the AMCA Seal.

The ratings shown are based on tests and procedures performed in accordance with AMCA Publication 211 and AMCA Publication 311 and comply with the requirements of the AMCA Certified Ratings Program.

Performance certified is for Installation type D: Ducted Inlet- Ducted Outlet. Performance ratings do not include the effects of appurtenances (accessories)

The Sound Power Level ratings shown are in decibels, referred to  $10^{-12}$  watts, calculated per AMCA International Standard 301. Values shown are for inlet LWi and LWiA sound power levels for Installation type D: Ducted Inlet-Ducted Outlet. Ratings include the effects of duct end correction.

The A-weighted sound ratings shown have been calculated per AMCA International Standard 301.



# Fan Code: 71JMC/25/4/9/...

## 710 mm 1440 rev/min 9 Blades 50 Hz



### Performance Data ISO 5801:

Performance certified is for installation type D-Ducted inlet, Ducted outlet. Performance ratings do not include the effects of appurtenances (accessories).

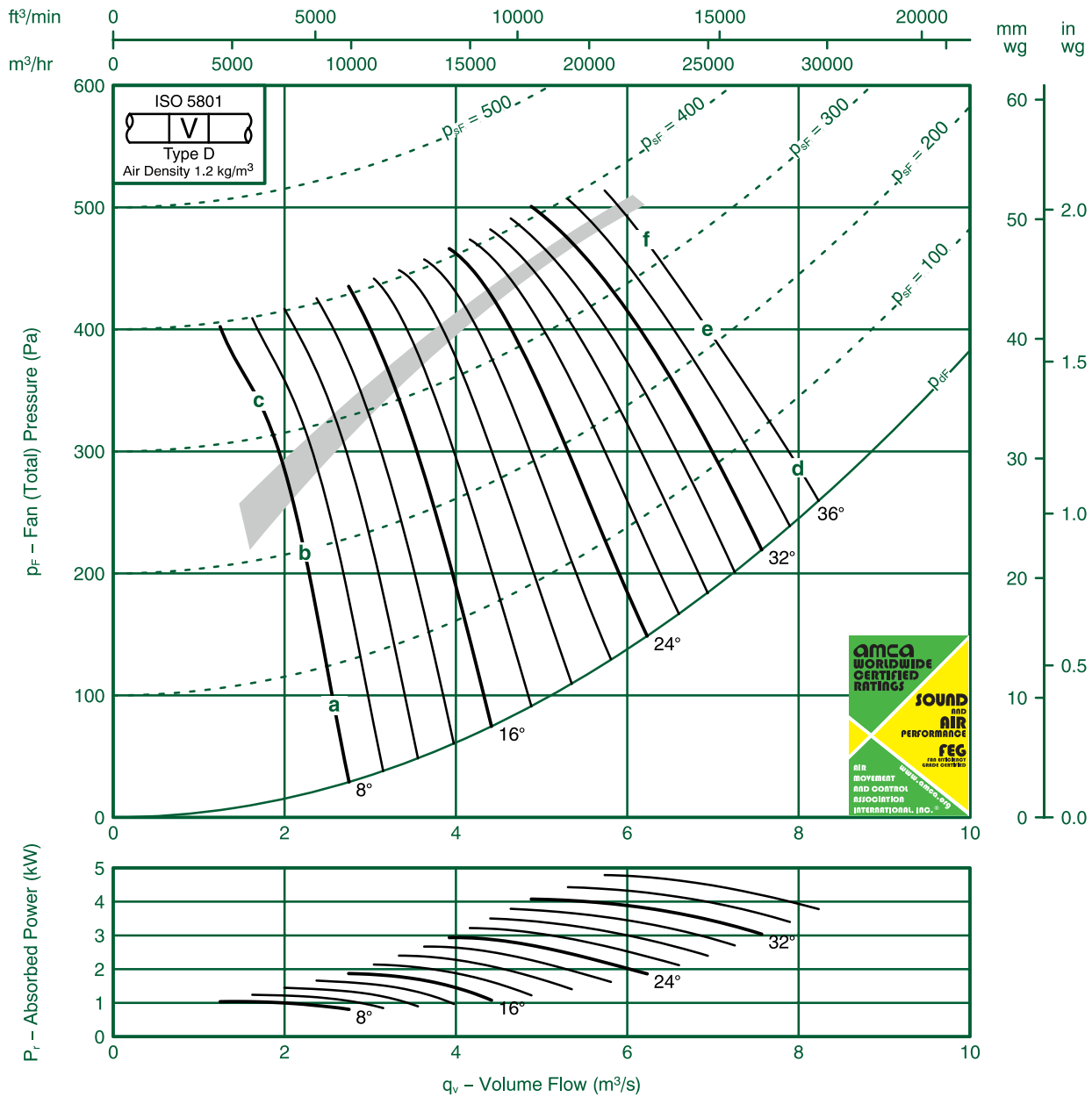

| Ref | FULL OCTAVE BAND FREQUENCY |        |        |        |       |       |       |       | LWA |
|-----|----------------------------|--------|--------|--------|-------|-------|-------|-------|-----|
|     | 63 Hz                      | 125 Hz | 250 Hz | 500 Hz | 1K Hz | 2K Hz | 4K Hz | 8K Hz |     |
| a   | 86                         | 81     | 80     | 85     | 83    | 80    | 79    | 70    | 88  |
| b   | 82                         | 81     | 81     | 90     | 88    | 84    | 77    | 69    | 92  |
| c   | 99                         | 101    | 93     | 89     | 84    | 80    | 75    | 70    | 91  |
| d   | 100                        | 88     | 90     | 91     | 87    | 83    | 82    | 80    | 93  |
| e   | 101                        | 87     | 89     | 91     | 86    | 84    | 82    | 81    | 92  |
| f   | 102                        | 87     | 88     | 91     | 86    | 84    | 82    | 82    | 93  |

FlaktGroup India Pvt. Ltd. certifies that the 71JMC/25/4/9 series shown herein are Licensed to bear the AMCA Seal.

The ratings shown are based on tests and procedures performed in accordance with AMCA Publication 211 and AMCA Publication 311 and comply with the requirements of the AMCA Certified Ratings Program.

Performance certified is for Installation type D: Ducted Inlet- Ducted Outlet. Performance ratings do not include the effects of appurtenances (accessories)

The Sound Power Level ratings shown are in decibels, referred to  $10^{-12}$  watts, calculated per AMCA International Standard 301. Values shown are for inlet LWi and LWiA sound power levels for Installation type D: Ducted Inlet-Ducted Outlet. Ratings include the effects of duct end correction.

The A-weighted sound ratings shown have been calculated per AMCA International Standard 301.



# Fan Code: 80JMC/20/8/3/... 800 mm 695 rev/min 3 Blades 50 Hz



### Performance Data ISO 5801:

Performance certified is for installation type D-Ducted inlet, Ducted outlet. Performance ratings do not include the effects of appurtenances (accessories).

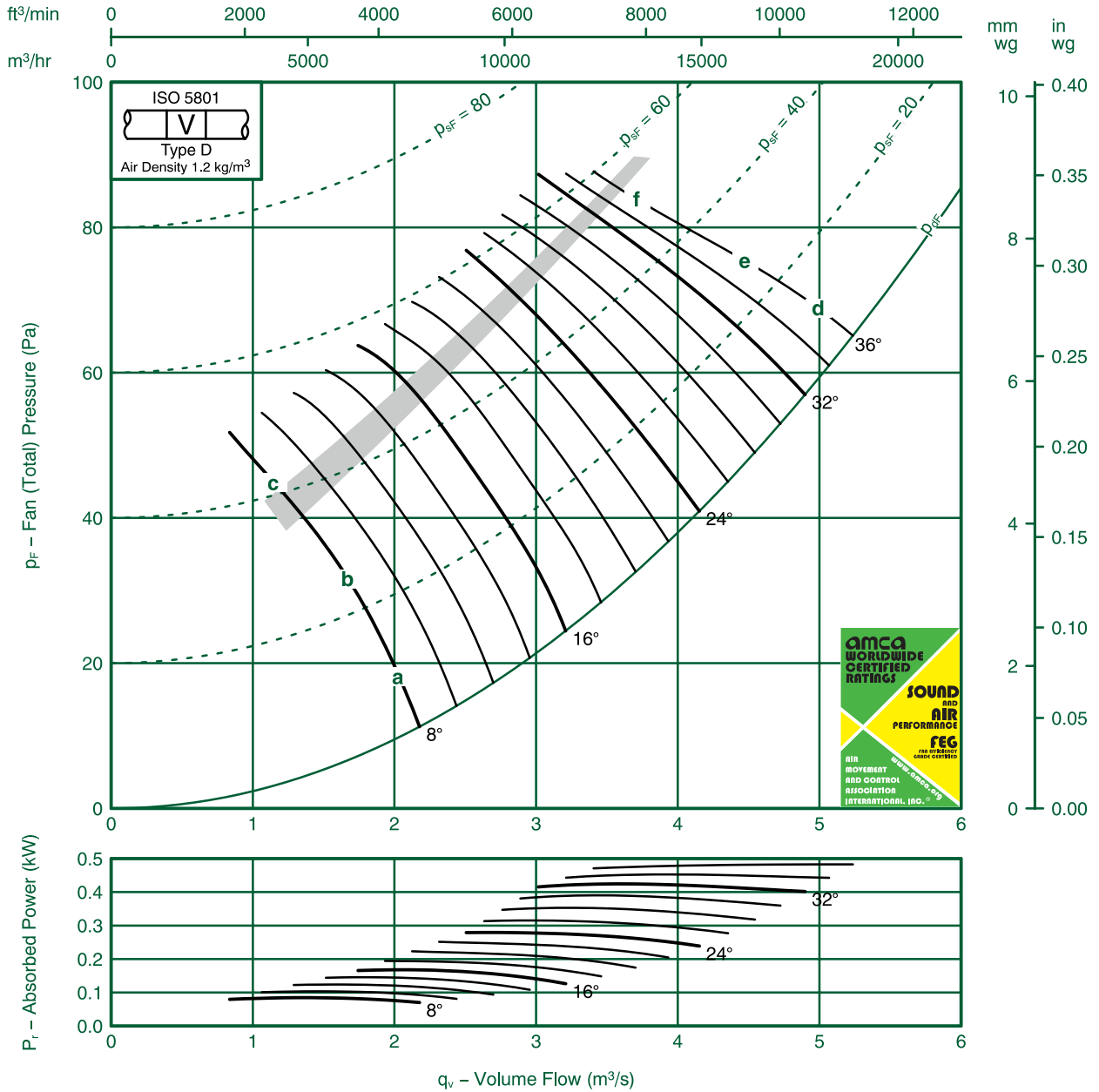

| Ref | FULL OCTAVE BAND FREQUENCY |        |        |        |       |       |       |       | LWA |
|-----|----------------------------|--------|--------|--------|-------|-------|-------|-------|-----|
|     | 63 Hz                      | 125 Hz | 250 Hz | 500 Hz | 1K Hz | 2K Hz | 4K Hz | 8K Hz |     |
| a   | 71                         | 71     | 67     | 68     | 68    | 66    | 63    | 59    | 73  |
| b   | 69                         | 75     | 77     | 74     | 68    | 62    | 57    | 52    | 75  |
| c   | 69                         | 84     | 85     | 78     | 69    | 62    | 57    | 51    | 80  |
| d   | 85                         | 78     | 75     | 77     | 74    | 69    | 67    | 65    | 79  |
| e   | 92                         | 80     | 76     | 76     | 76    | 72    | 68    | 66    | 80  |
| f   | 83                         | 75     | 76     | 77     | 73    | 68    | 66    | 63    | 78  |

FlaktGroup India Pvt. Ltd. certifies that the 80JMC/20/8/3 series shown herein are Licensed to bear the AMCA Seal.

The ratings shown are based on tests and procedures performed in accordance with AMCA Publication 211 and AMCA Publication 311 and comply with the requirements of the AMCA Certified Ratings Program.

Performance certified is for Installation type D: Ducted Inlet- Ducted Outlet. Performance ratings do not include the effects of appurtenances (accessories)

The Sound Power Level ratings shown are in decibels, referred to  $10^{-12}$  watts, calculated per AMCA International Standard 301. Values shown are for inlet LWi and LWiA sound power levels for Installation type D: Ducted Inlet-Ducted Outlet. Ratings include the effects of duct end correction.

The A-weighted sound ratings shown have been calculated per AMCA International Standard 301.



# Fan Code: 80JMC/25/8/6/...

## 800 mm 695 rev/min 6 Blades 50 Hz



**FEG75**

**Performance Data ISO 5801:**

Performance certified is for installation type D-Ducted inlet, Ducted outlet. Performance ratings do not include the effects of appurtenances (accessories).

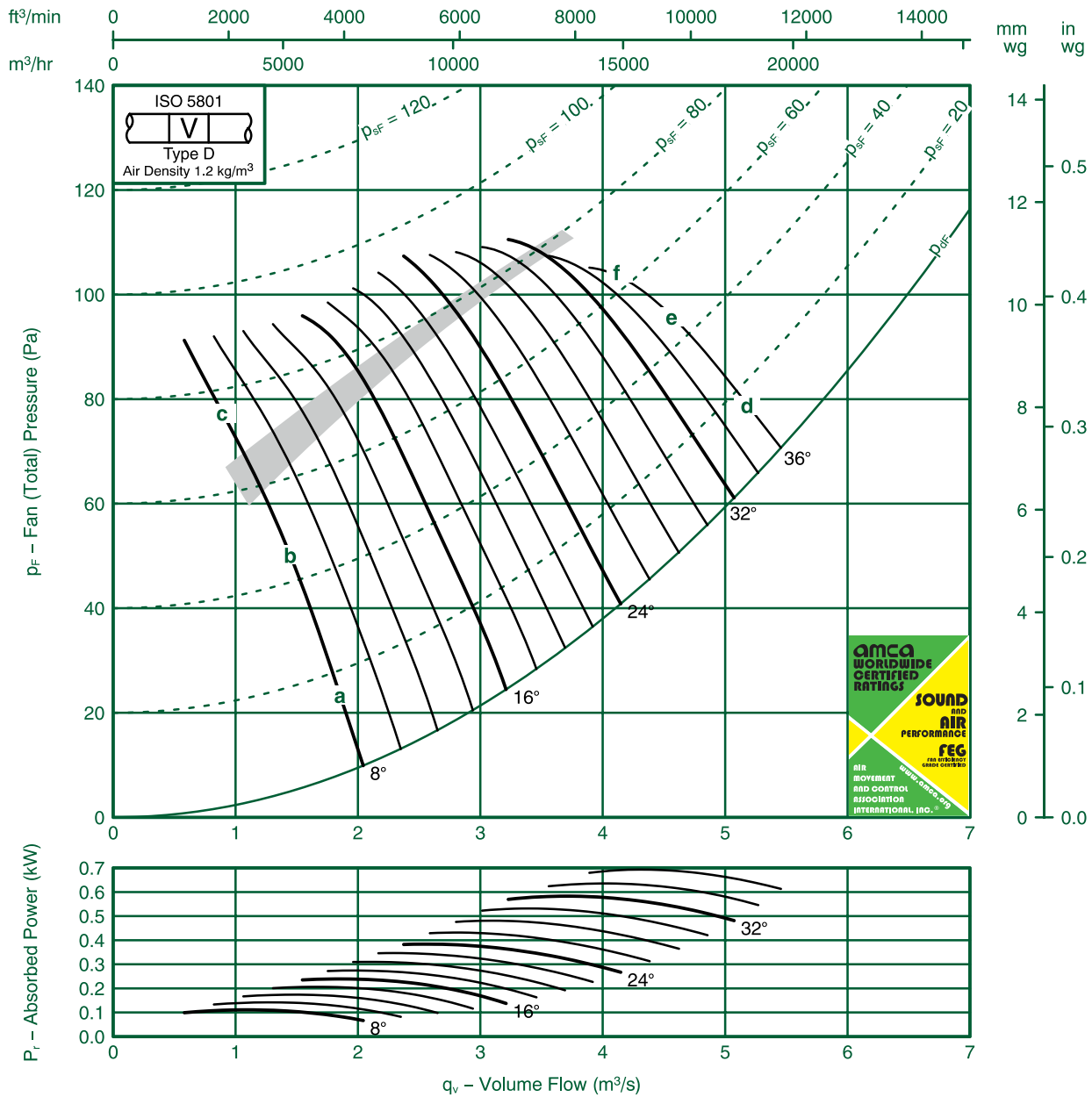

| Ref | FULL OCTAVE BAND FREQUENCY |        |        |        |       |       |       |       | LWA |
|-----|----------------------------|--------|--------|--------|-------|-------|-------|-------|-----|
|     | 63 Hz                      | 125 Hz | 250 Hz | 500 Hz | 1K Hz | 2K Hz | 4K Hz | 8K Hz |     |
| a   | 65                         | 64     | 68     | 69     | 67    | 65    | 60    | 56    | 72  |
| b   | 68                         | 74     | 78     | 76     | 71    | 66    | 60    | 54    | 77  |
| c   | 83                         | 85     | 78     | 73     | 69    | 65    | 60    | 54    | 76  |
| d   | 75                         | 76     | 78     | 77     | 75    | 71    | 69    | 67    | 80  |
| e   | 77                         | 76     | 78     | 77     | 75    | 71    | 69    | 67    | 80  |
| f   | 87                         | 80     | 79     | 80     | 77    | 74    | 69    | 66    | 82  |

FlaktGroup India Pvt. Ltd. certifies that the 80JMC/25/8/6 series shown herein are Licensed to bear the AMCA Seal.

The ratings shown are based on tests and procedures performed in accordance with AMCA Publication 211 and AMCA Publication 311 and comply with the requirements of the AMCA Certified Ratings Program.

Performance certified is for Installation type D: Ducted Inlet- Ducted Outlet. Performance ratings do not include the effects of appurtenances (accessories)

The Sound Power Level ratings shown are in decibels, referred to 10<sup>-12</sup> watts, calculated per AMCA International Standard 301. Values shown are for inlet LWi and LWiA sound power levels for Installation type D: Ducted Inlet-Ducted Outlet. Ratings include the effects of duct end correction.

The A-weighted sound ratings shown have been calculated per AMCA International Standard 301.



# Fan Code: 80JMC/25/8/9/... 800 mm 695 rev/min 9 Blades 50 Hz



**FEG71**

**Performance Data ISO 5801:**

Performance certified is for installation type D-Ducted inlet, Ducted outlet. Performance ratings do not include the effects of appurtenances (accessories).

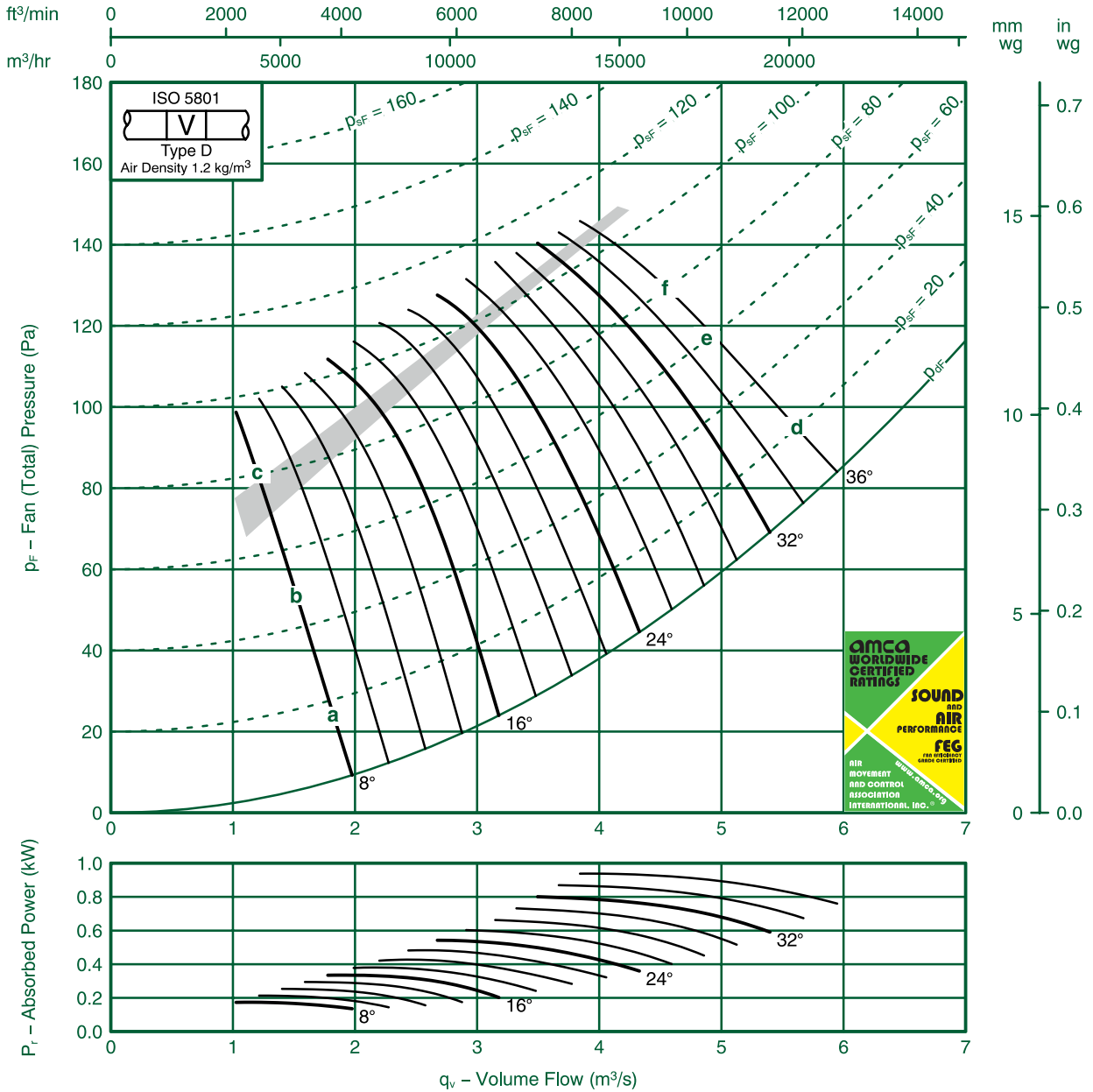

| Ref | FULL OCTAVE BAND FREQUENCY |        |        |        |       |       |       |       | LWA |
|-----|----------------------------|--------|--------|--------|-------|-------|-------|-------|-----|
|     | 63 Hz                      | 125 Hz | 250 Hz | 500 Hz | 1K Hz | 2K Hz | 4K Hz | 8K Hz |     |
| a   | 62                         | 69     | 71     | 71     | 68    | 66    | 62    | 57    | 73  |
| b   | 66                         | 72     | 77     | 78     | 73    | 67    | 60    | 53    | 78  |
| c   | 77                         | 82     | 81     | 78     | 71    | 65    | 58    | 51    | 78  |
| d   | 71                         | 76     | 77     | 74     | 71    | 69    | 68    | 67    | 78  |
| e   | 72                         | 77     | 78     | 75     | 72    | 69    | 68    | 66    | 78  |
| f   | 74                         | 77     | 78     | 75     | 73    | 70    | 68    | 66    | 78  |

FlaktGroup India Pvt. Ltd. certifies that the 80JMC/25/8/9 series shown herein are Licensed to bear the AMCA Seal.

The ratings shown are based on tests and procedures performed in accordance with AMCA Publication 211 and AMCA Publication 311 and comply with the requirements of the AMCA Certified Ratings Program.

Performance certified is for Installation type D: Ducted Inlet- Ducted Outlet. Performance ratings do not include the effects of appurtenances (accessories)

The Sound Power Level ratings shown are in decibels, referred to  $10^{-12}$  watts, calculated per AMCA International Standard 301. Values shown are for inlet LWi and LWiA sound power levels for Installation type D: Ducted Inlet-Ducted Outlet. Ratings include the effects of duct end correction.

The A-weighted sound ratings shown have been calculated per AMCA International Standard 301.





# Fan Code: 80JMC/20/6/3/...

## 800 mm 935 rev/min 3 Blades 50 Hz



**FEG80**

**Performance Data ISO 5801:**

Performance certified is for installation type D-Ducted inlet, Ducted outlet. Performance ratings do not include the effects of appurtenances (accessories).

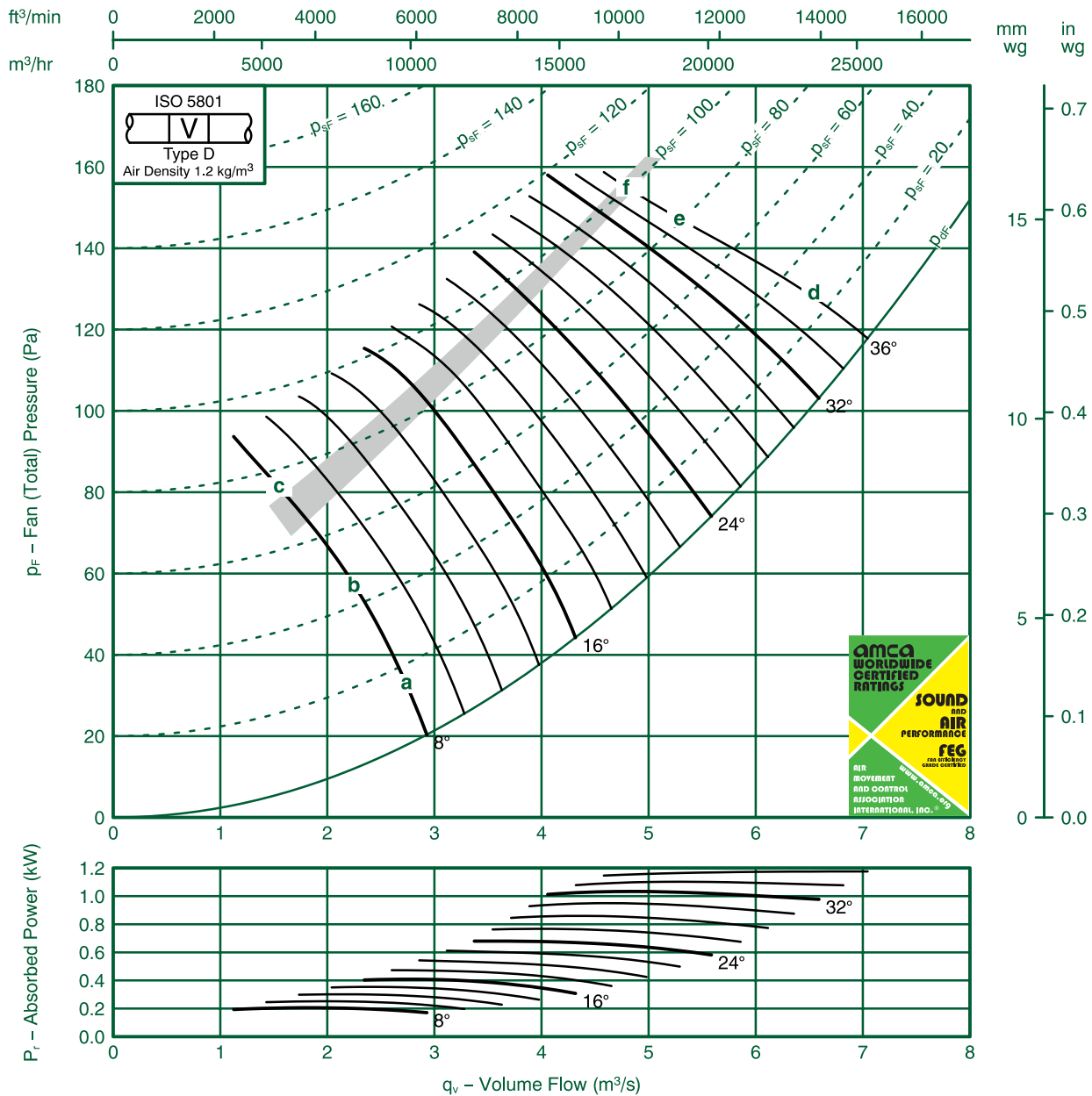

| Ref | FULL OCTAVE BAND FREQUENCY |        |        |        |       |       |       |       | LWA |
|-----|----------------------------|--------|--------|--------|-------|-------|-------|-------|-----|
|     | 63 Hz                      | 125 Hz | 250 Hz | 500 Hz | 1K Hz | 2K Hz | 4K Hz | 8K Hz |     |
| a   | 77                         | 77     | 74     | 74     | 75    | 72    | 69    | 65    | 79  |
| b   | 80                         | 77     | 79     | 80     | 76    | 71    | 66    | 61    | 81  |
| c   | 79                         | 85     | 92     | 87     | 79    | 71    | 66    | 60    | 88  |
| d   | 96                         | 87     | 82     | 83     | 82    | 78    | 74    | 72    | 86  |
| e   | 100                        | 83     | 81     | 83     | 81    | 77    | 74    | 72    | 86  |
| f   | 100                        | 85     | 82     | 83     | 81    | 76    | 73    | 70    | 86  |

FlaktGroup India Pvt. Ltd. certifies that the 80JMC/20/6/3 series shown herein are Licensed to bear the AMCA Seal.

The ratings shown are based on tests and procedures performed in accordance with AMCA Publication 211 and AMCA Publication 311 and comply with the requirements of the AMCA Certified Ratings Program.

Performance certified is for Installation type D: Ducted Inlet- Ducted Outlet. Performance ratings do not include the effects of appurtenances (accessories)

The Sound Power Level ratings shown are in decibels, referred to  $10^{-12}$  watts, calculated per AMCA International Standard 301. Values shown are for inlet LWi and LWiA sound power levels for Installation type D: Ducted Inlet-Ducted Outlet. Ratings include the effects of duct end correction.

The A-weighted sound ratings shown have been calculated per AMCA International Standard 301.



# Fan Code: 80JMC/25/6/6/... 800 mm 935 rev/min 6 Blades 50 Hz



**FEG75**

**Performance Data ISO 5801:**

Performance certified is for installation type D-Ducted inlet, Ducted outlet. Performance ratings do not include the effects of appurtenances (accessories).

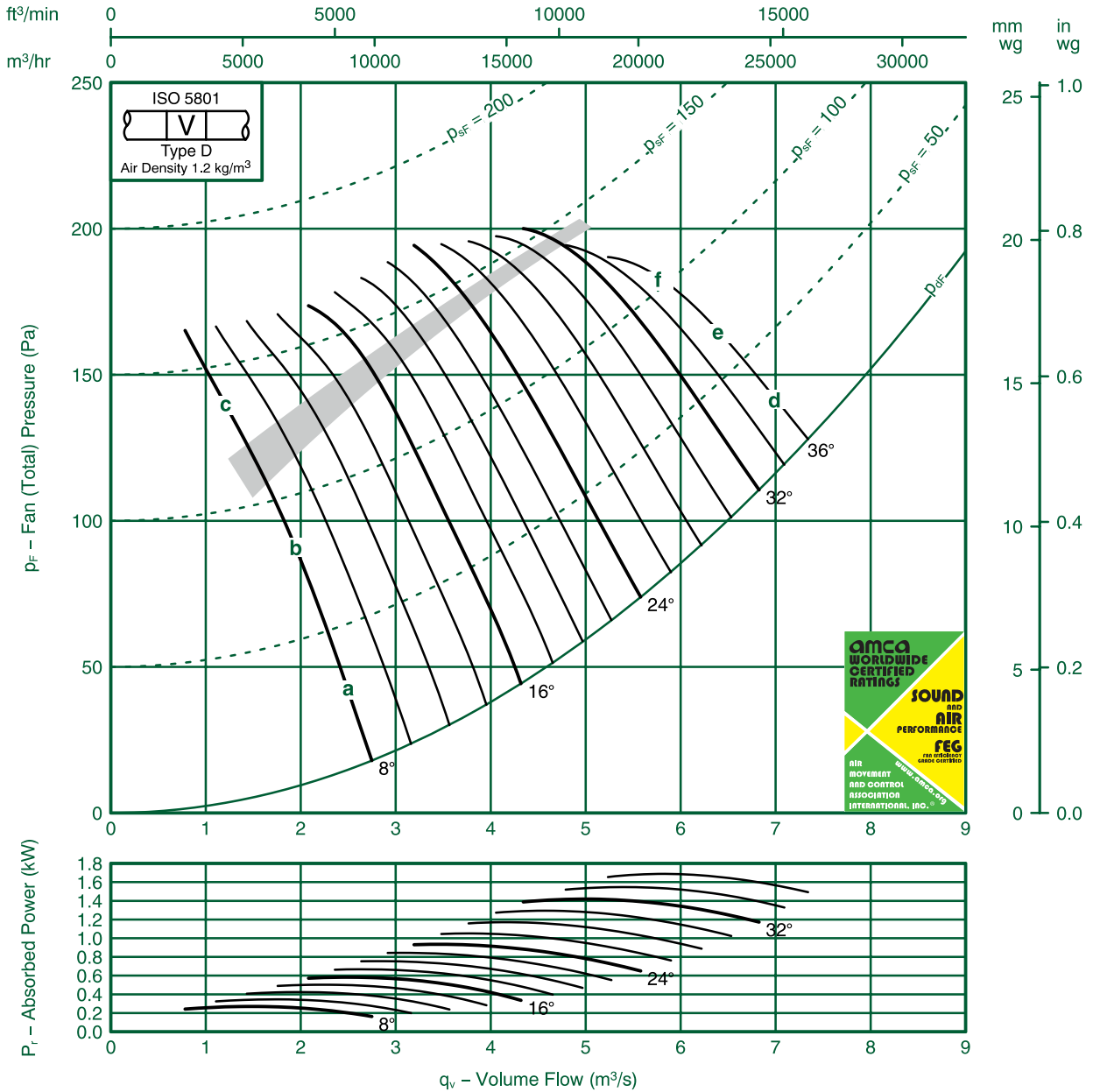

| Ref | FULL OCTAVE BAND FREQUENCY |        |        |        |       |       |       |       | LWA |
|-----|----------------------------|--------|--------|--------|-------|-------|-------|-------|-----|
|     | 63 Hz                      | 125 Hz | 250 Hz | 500 Hz | 1K Hz | 2K Hz | 4K Hz | 8K Hz |     |
| a   | 74                         | 73     | 75     | 76     | 74    | 72    | 68    | 64    | 79  |
| b   | 74                         | 75     | 80     | 81     | 78    | 74    | 69    | 63    | 82  |
| c   | 90                         | 91     | 88     | 82     | 77    | 73    | 68    | 63    | 85  |
| d   | 85                         | 81     | 83     | 83     | 82    | 79    | 77    | 75    | 87  |
| e   | 87                         | 83     | 84     | 84     | 83    | 79    | 76    | 74    | 87  |
| f   | 88                         | 86     | 86     | 85     | 83    | 79    | 76    | 73    | 88  |

FlaktGroup India Pvt. Ltd. certifies that the 80JMC/25/6/6 series shown herein are Licensed to bear the AMCA Seal.

The ratings shown are based on tests and procedures performed in accordance with AMCA Publication 211 and AMCA Publication 311 and comply with the requirements of the AMCA Certified Ratings Program.

Performance certified is for Installation type D: Ducted Inlet- Ducted Outlet. Performance ratings do not include the effects of appurtenances (accessories)

The Sound Power Level ratings shown are in decibels, referred to  $10^{-12}$  watts, calculated per AMCA International Standard 301. Values shown are for inlet LWi and LWiA sound power levels for Installation type D: Ducted Inlet-Ducted Outlet. Ratings include the effects of duct end correction.

The A-weighted sound ratings shown have been calculated per AMCA International Standard 301.



# Fan Code: 80JMC/25/6/9/...

## 800 mm 935 rev/min 9 Blades 50 Hz



**FEG71**

**Performance Data ISO 5801:**

Performance certified is for installation type D-Ducted inlet, Ducted outlet. Performance ratings do not include the effects of appurtenances (accessories).

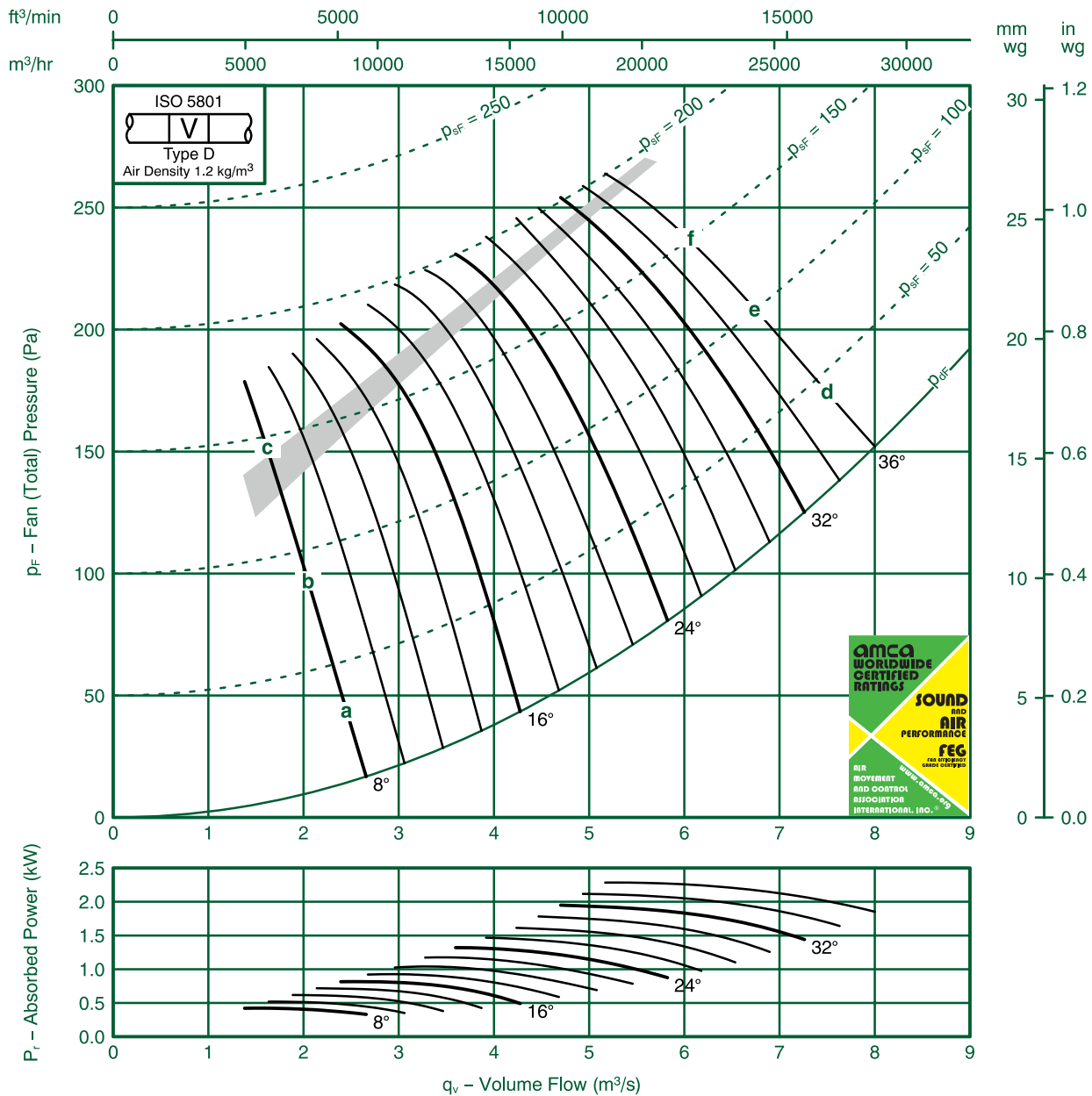

| Ref | FULL OCTAVE BAND FREQUENCY |        |        |        |       |       |       |       | LWA |
|-----|----------------------------|--------|--------|--------|-------|-------|-------|-------|-----|
|     | 63 Hz                      | 125 Hz | 250 Hz | 500 Hz | 1K Hz | 2K Hz | 4K Hz | 8K Hz |     |
| a   | 74                         | 75     | 77     | 77     | 75    | 73    | 70    | 65    | 80  |
| b   | 73                         | 78     | 82     | 84     | 82    | 76    | 69    | 62    | 86  |
| c   | 83                         | 88     | 88     | 86     | 80    | 74    | 67    | 60    | 86  |
| d   | 82                         | 83     | 84     | 82     | 79    | 76    | 75    | 73    | 85  |
| e   | 83                         | 83     | 84     | 82     | 79    | 77    | 75    | 74    | 85  |
| f   | 84                         | 83     | 84     | 83     | 81    | 78    | 75    | 74    | 86  |

FlaktGroup India Pvt. Ltd. certifies that the 80JMC/25/6/9 series shown herein are Licensed to bear the AMCA Seal.

The ratings shown are based on tests and procedures performed in accordance with AMCA Publication 211 and AMCA Publication 311 and comply with the requirements of the AMCA Certified Ratings Program.

Performance certified is for Installation type D: Ducted Inlet- Ducted Outlet. Performance ratings do not include the effects of appurtenances (accessories)

The Sound Power Level ratings shown are in decibels, referred to  $10^{-12}$  watts, calculated per AMCA International Standard 301. Values shown are for inlet LWi and LWiA sound power levels for Installation type D: Ducted Inlet-Ducted Outlet. Ratings include the effects of duct end correction.

The A-weighted sound ratings shown have been calculated per AMCA International Standard 301.



# Fan Code: 80JMC/20/4/3/... 800 mm 1440 rev/min 3 Blades 50 Hz



## Performance Data ISO 5801:

Performance certified is for installation type D-Ducted inlet, Ducted outlet. Performance ratings do not include the effects of appurtenances (accessories).

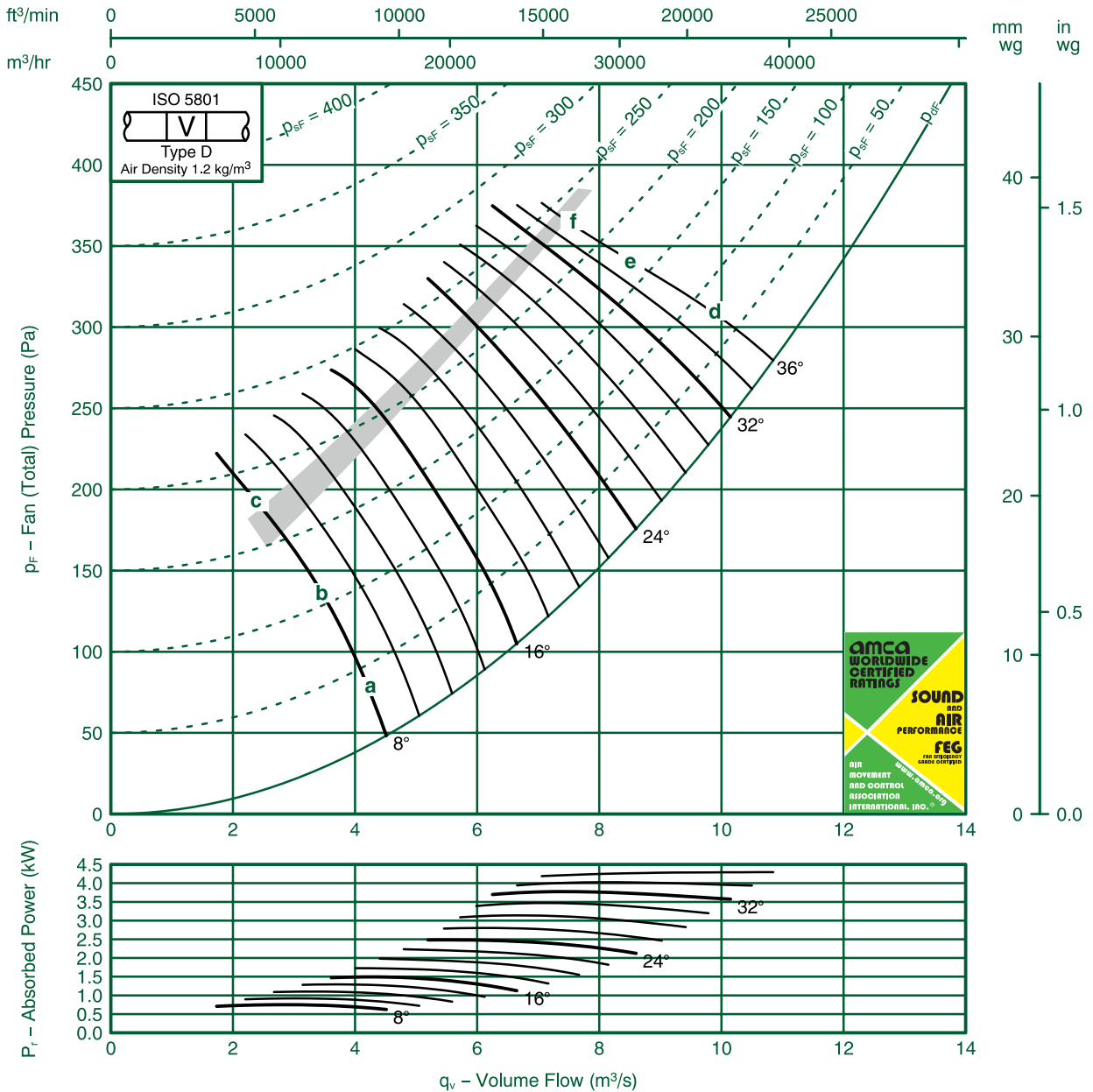

| Ref | FULL OCTAVE BAND FREQUENCY |        |        |        |       |       |       |       | LWA |
|-----|----------------------------|--------|--------|--------|-------|-------|-------|-------|-----|
|     | 63 Hz                      | 125 Hz | 250 Hz | 500 Hz | 1K Hz | 2K Hz | 4K Hz | 8K Hz |     |
| a   | 86                         | 87     | 83     | 84     | 84    | 82    | 78    | 75    | 89  |
| b   | 89                         | 84     | 87     | 90     | 89    | 84    | 78    | 73    | 92  |
| c   | 88                         | 84     | 99     | 101    | 93    | 84    | 78    | 73    | 100 |
| d   | 106                        | 102    | 93     | 91     | 93    | 91    | 85    | 83    | 97  |
| e   | 108                        | 98     | 90     | 91     | 93    | 89    | 84    | 82    | 97  |
| f   | 109                        | 99     | 91     | 92     | 93    | 89    | 84    | 81    | 97  |

FlaktGroup India Pvt. Ltd. certifies that the 80JMC/20/4/3 series shown herein are Licensed to bear the AMCA Seal.

The ratings shown are based on tests and procedures performed in accordance with AMCA Publication 211 and AMCA Publication 311 and comply with the requirements of the AMCA Certified Ratings Program.

Performance certified is for Installation type D: Ducted Inlet- Ducted Outlet. Performance ratings do not include the effects of appurtenances (accessories)

The Sound Power Level ratings shown are in decibels, referred to 10<sup>-12</sup> watts, calculated per AMCA International Standard 301. Values shown are for inlet LWi and LWiA sound power levels for Installation type D: Ducted Inlet-Ducted Outlet. Ratings include the effects of duct end correction.

The A-weighted sound ratings shown have been calculated per AMCA International Standard 301.



# Fan Code: 80JMC/25/4/6/...

## 800 mm 1440 rev/min 6 Blades 50 Hz



**FEG75**

**Performance Data ISO 5801:**

Performance certified is for installation type D-Ducted inlet, Ducted outlet. Performance ratings do not include the effects of appurtenances (accessories).

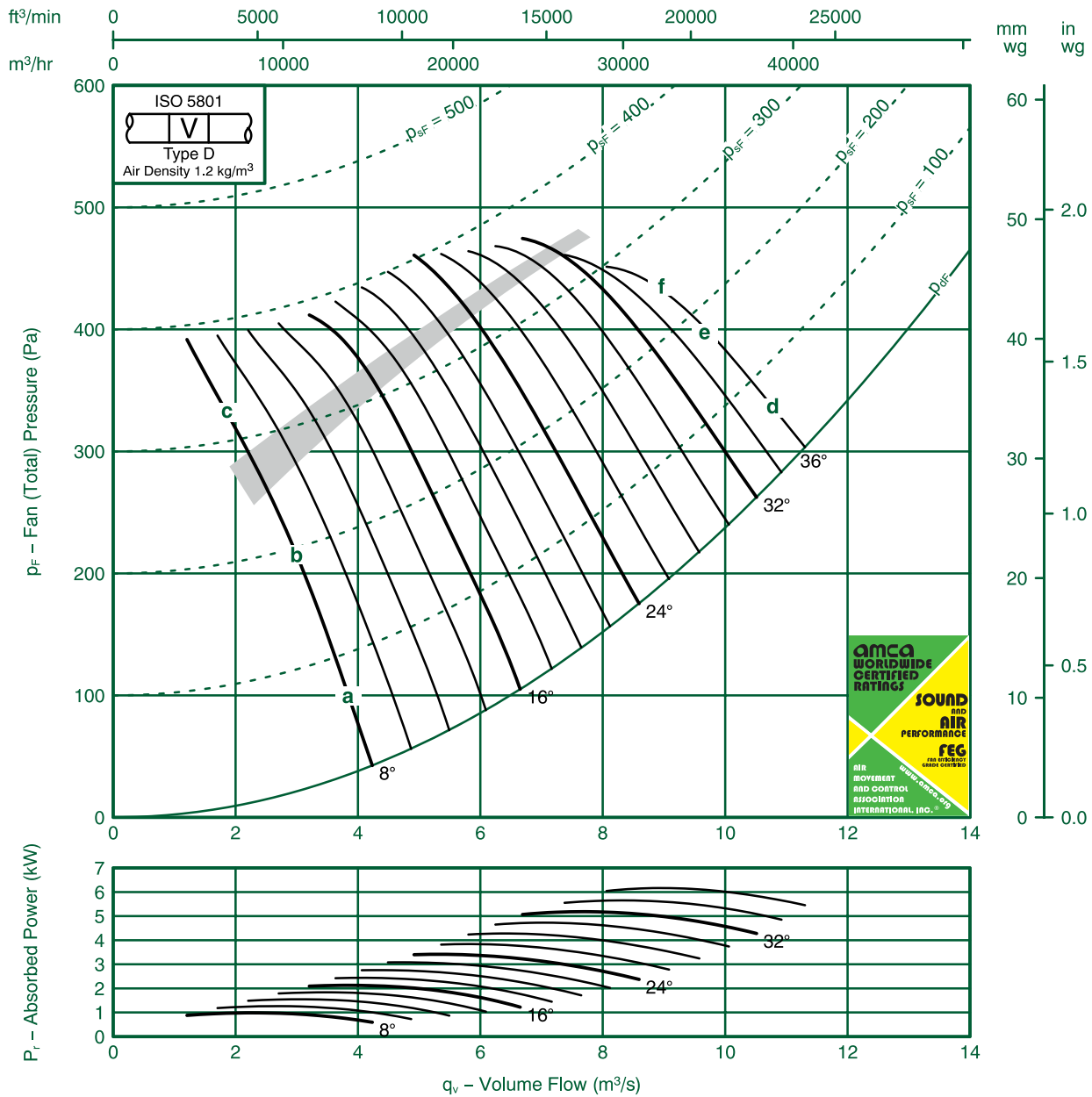

| Ref | FULL OCTAVE BAND FREQUENCY |        |        |        |       |       |       |       | LWA |
|-----|----------------------------|--------|--------|--------|-------|-------|-------|-------|-----|
|     | 63 Hz                      | 125 Hz | 250 Hz | 500 Hz | 1K Hz | 2K Hz | 4K Hz | 8K Hz |     |
| a   | 88                         | 81     | 83     | 86     | 86    | 83    | 81    | 76    | 90  |
| b   | 87                         | 83     | 89     | 94     | 92    | 87    | 82    | 76    | 96  |
| c   | 100                        | 98     | 101    | 94     | 90    | 85    | 81    | 75    | 97  |
| d   | 102                        | 91     | 91     | 93     | 92    | 92    | 87    | 85    | 98  |
| e   | 103                        | 93     | 92     | 94     | 93    | 92    | 87    | 85    | 98  |
| f   | 102                        | 98     | 96     | 98     | 95    | 91    | 86    | 82    | 100 |

FlaktGroup India Pvt. Ltd. certifies that the 80JMC/25/4/6 series shown herein are Licensed to bear the AMCA Seal.

The ratings shown are based on tests and procedures performed in accordance with AMCA Publication 211 and AMCA Publication 311 and comply with the requirements of the AMCA Certified Ratings Program.

Performance certified is for Installation type D: Ducted Inlet- Ducted Outlet. Performance ratings do not include the effects of appurtenances (accessories)

The Sound Power Level ratings shown are in decibels, referred to  $10^{-12}$  watts, calculated per AMCA International Standard 301. Values shown are for inlet LWi and LWiA sound power levels for Installation type D: Ducted Inlet-Ducted Outlet. Ratings include the effects of duct end correction.

The A-weighted sound ratings shown have been calculated per AMCA International Standard 301.



# Fan Code: 80JMC/25/4/9/... 800 mm 1440 rev/min 9 Blades 50 Hz



**FEG71**

**Performance Data ISO 5801:**

Performance certified is for installation type D-Ducted inlet, Ducted outlet. Performance ratings do not include the effects of appurtenances (accessories).

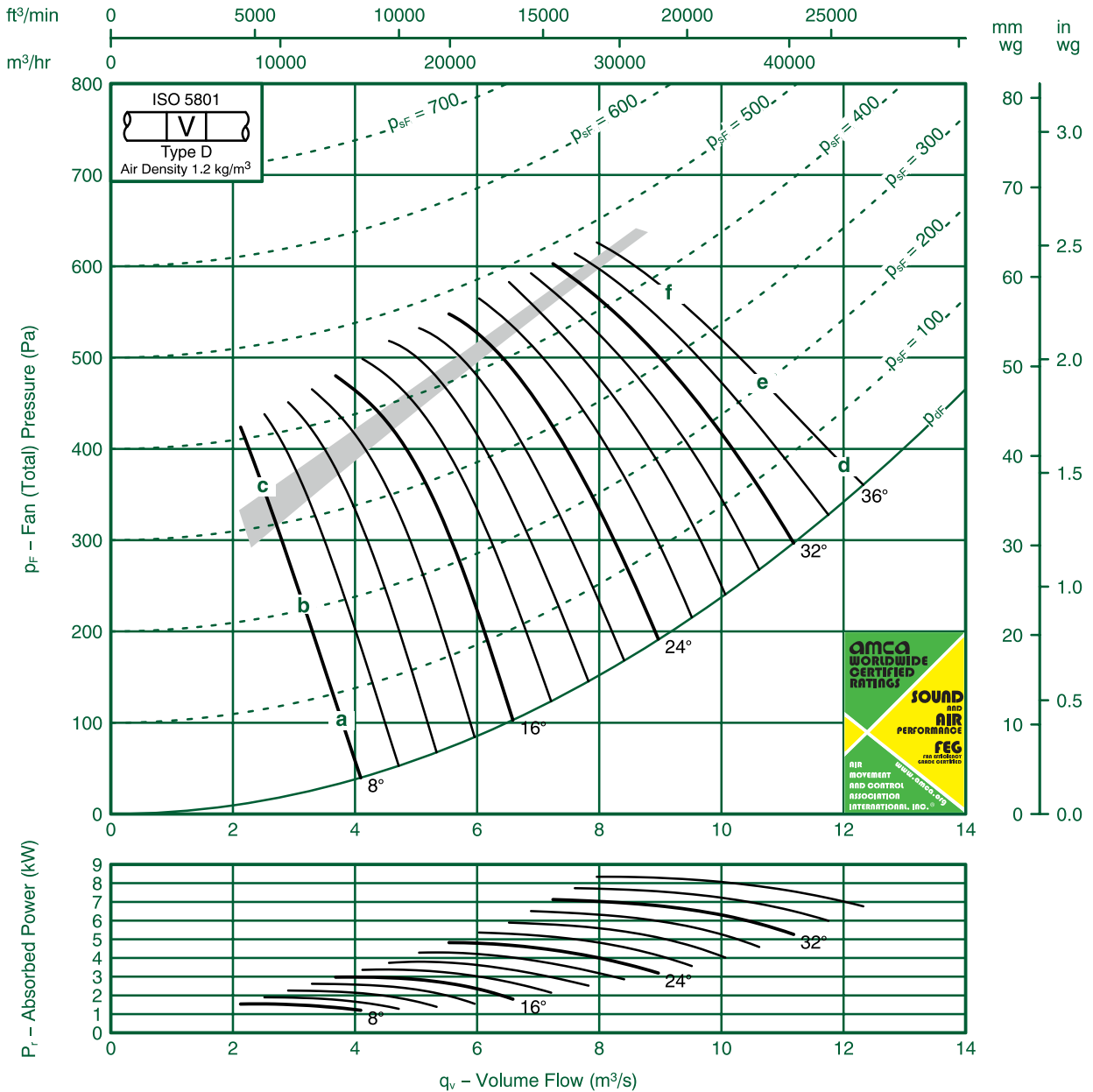

| Ref | FULL OCTAVE BAND FREQUENCY |        |        |        |       |       |       |       | LWA |
|-----|----------------------------|--------|--------|--------|-------|-------|-------|-------|-----|
|     | 63 Hz                      | 125 Hz | 250 Hz | 500 Hz | 1K Hz | 2K Hz | 4K Hz | 8K Hz |     |
| a   | 95                         | 78     | 85     | 87     | 87    | 83    | 82    | 78    | 91  |
| b   | 85                         | 81     | 88     | 92     | 94    | 89    | 83    | 76    | 97  |
| c   | 94                         | 92     | 98     | 97     | 94    | 87    | 81    | 74    | 98  |
| d   | 103                        | 86     | 93     | 93     | 90    | 87    | 85    | 84    | 96  |
| e   | 102                        | 86     | 93     | 93     | 90    | 88    | 85    | 84    | 96  |
| f   | 102                        | 89     | 93     | 94     | 91    | 89    | 86    | 84    | 97  |

FlaktGroup India Pvt. Ltd. certifies that the 80JMC/25/4/9 series shown herein are Licensed to bear the AMCA Seal.

The ratings shown are based on tests and procedures performed in accordance with AMCA Publication 211 and AMCA Publication 311 and comply with the requirements of the AMCA Certified Ratings Program.

Performance certified is for Installation type D: Ducted Inlet- Ducted Outlet. Performance ratings do not include the effects of appurtenances (accessories)

The Sound Power Level ratings shown are in decibels, referred to 10<sup>-12</sup> watts, calculated per AMCA International Standard 301. Values shown are for inlet LWi and LWiA sound power levels for Installation type D: Ducted Inlet-Ducted Outlet. Ratings include the effects of duct end correction.

The A-weighted sound ratings shown have been calculated per AMCA International Standard 301.



# Fan Code: 90JMC/25/8/3/...

## 900 mm 695 rev/min 3 Blades 50 Hz



**FEG85**

**Performance Data ISO 5801:**

Performance certified is for installation type D-Ducted inlet, Ducted outlet. Performance ratings do not include the effects of appurtenances (accessories).

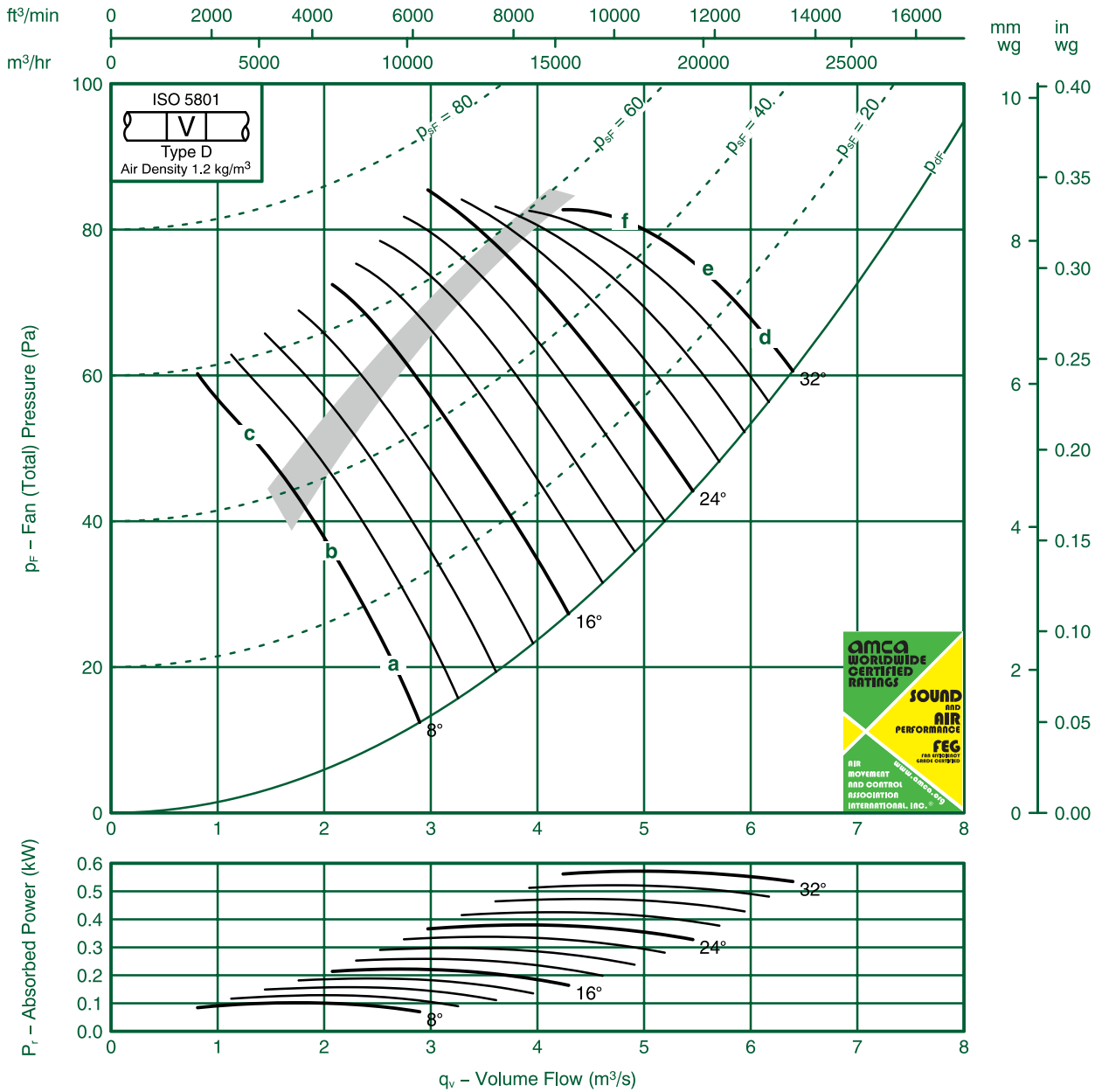

| Ref | FULL OCTAVE BAND FREQUENCY |        |        |        |       |       |       |       | LWA |
|-----|----------------------------|--------|--------|--------|-------|-------|-------|-------|-----|
|     | 63 Hz                      | 125 Hz | 250 Hz | 500 Hz | 1K Hz | 2K Hz | 4K Hz | 8K Hz |     |
| a   | 66                         | 69     | 69     | 69     | 66    | 65    | 65    | 64    | 73  |
| b   | 64                         | 69     | 70     | 70     | 65    | 63    | 62    | 62    | 72  |
| c   | 78                         | 82     | 78     | 74     | 69    | 66    | 63    | 61    | 76  |
| d   | 74                         | 75     | 76     | 76     | 76    | 72    | 71    | 69    | 80  |
| e   | 73                         | 74     | 75     | 76     | 75    | 72    | 70    | 69    | 80  |
| f   | 74                         | 74     | 75     | 76     | 74    | 71    | 69    | 68    | 79  |

FlaktGroup India Pvt. Ltd. certifies that the 90JMC/25/8/3 series shown herein are Licensed to bear the AMCA Seal.

The ratings shown are based on tests and procedures performed in accordance with AMCA Publication 211 and AMCA Publication 311 and comply with the requirements of the AMCA Certified Ratings Program.

Performance certified is for Installation type D: Ducted Inlet- Ducted Outlet. Performance ratings do not include the effects of appurtenances (accessories)

The Sound Power Level ratings shown are in decibels, referred to  $10^{-12}$  watts, calculated per AMCA International Standard 301. Values shown are for inlet LWi and LWiA sound power levels for Installation type D: Ducted Inlet-Ducted Outlet. Ratings include the effects of duct end correction.

The A-weighted sound ratings shown have been calculated per AMCA International Standard 301.



# Fan Code: 90JMC/25/8/6/... 900 mm 695 rev/min 6 Blades 50 Hz



### Performance Data ISO 5801:

Performance certified is for installation type D-Ducted inlet, Ducted outlet. Performance ratings do not include the effects of appurtenances (accessories).

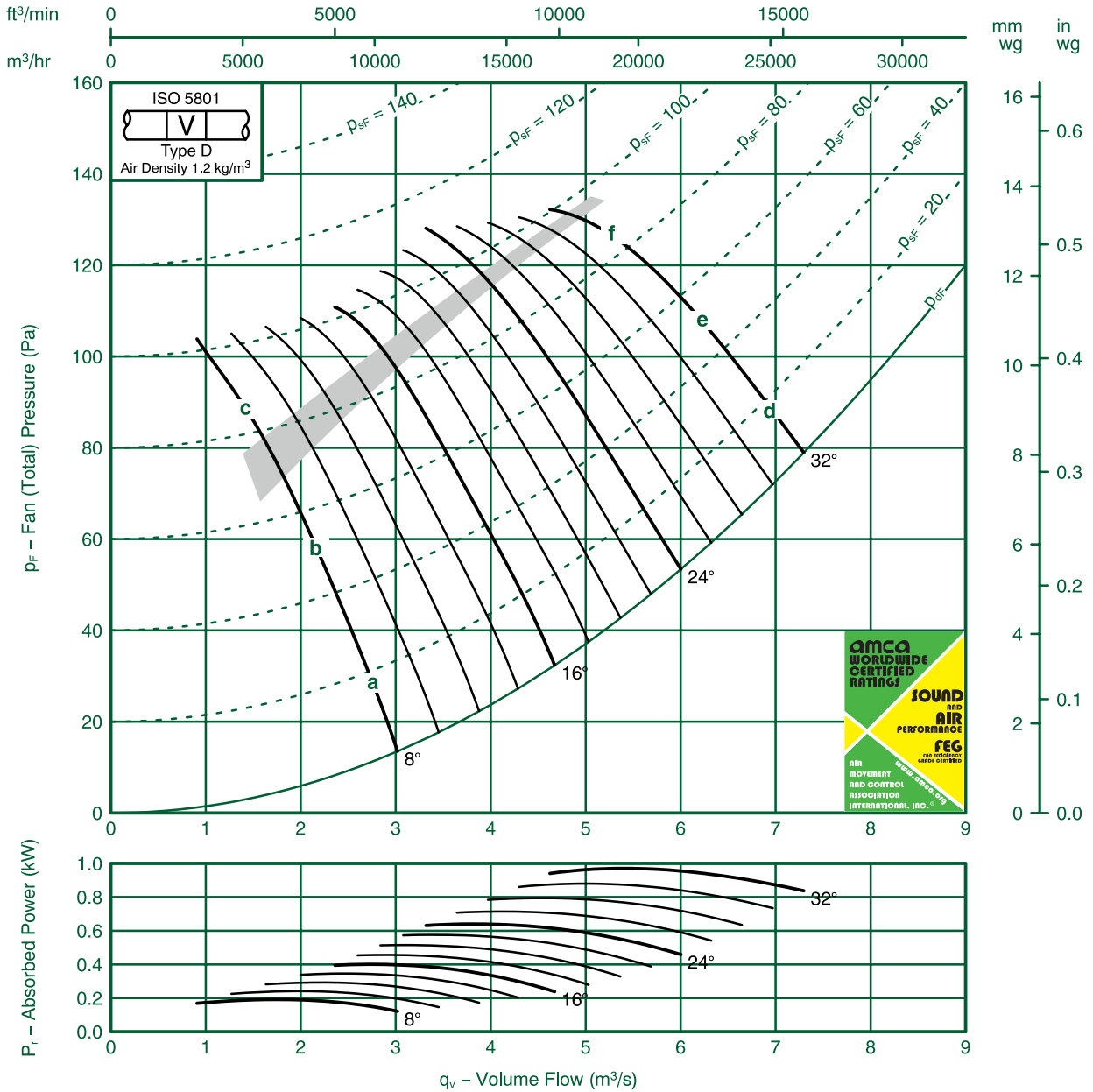

| Ref | FULL OCTAVE BAND FREQUENCY |        |        |        |       |       |       |       | LWA |
|-----|----------------------------|--------|--------|--------|-------|-------|-------|-------|-----|
|     | 63 Hz                      | 125 Hz | 250 Hz | 500 Hz | 1K Hz | 2K Hz | 4K Hz | 8K Hz |     |
| a   | 68                         | 73     | 76     | 76     | 72    | 70    | 68    | 66    | 78  |
| b   | 71                         | 77     | 81     | 79     | 74    | 69    | 66    | 62    | 80  |
| c   | 76                         | 79     | 80     | 77     | 73    | 69    | 65    | 61    | 79  |
| d   | 75                         | 79     | 79     | 78     | 76    | 74    | 72    | 69    | 81  |
| e   | 76                         | 80     | 83     | 80     | 78    | 75    | 72    | 69    | 83  |
| f   | 88                         | 89     | 87     | 83     | 79    | 73    | 70    | 66    | 85  |

FlaktGroup India Pvt. Ltd. certifies that the 90JMC/25/8/6 series shown herein are Licensed to bear the AMCA Seal.

The ratings shown are based on tests and procedures performed in accordance with AMCA Publication 211 and AMCA Publication 311 and comply with the requirements of the AMCA Certified Ratings Program.

Performance certified is for Installation type D: Ducted Inlet- Ducted Outlet. Performance ratings do not include the effects of appurtenances (accessories)

The Sound Power Level ratings shown are in decibels, referred to 10<sup>-12</sup> watts, calculated per AMCA International Standard 301. Values shown are for inlet LWi and LWiA sound power levels for Installation type D: Ducted Inlet-Ducted Outlet. Ratings include the effects of duct end correction.

The A-weighted sound ratings shown have been calculated per AMCA International Standard 301.





# Fan Code: 90JMC/25/6/3/...

## 900 mm 935 rev/min 3 Blades 50 Hz



**FEG85**

**Performance Data ISO 5801:**

Performance certified is for installation type D-Ducted inlet, Ducted outlet. Performance ratings do not include the effects of appurtenances (accessories).

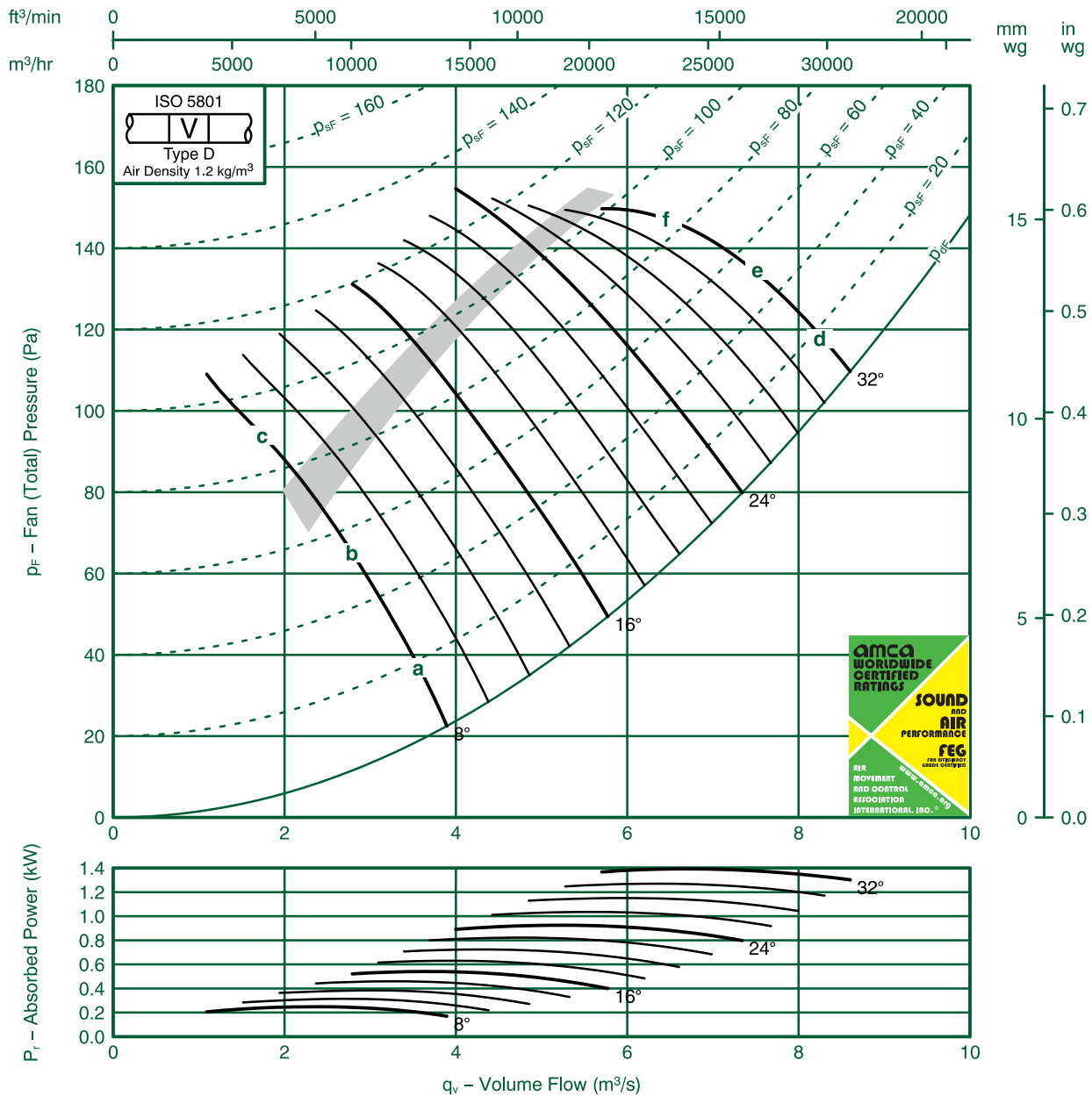

| Ref | FULL OCTAVE BAND FREQUENCY |        |        |        |       |       |       |       | LWA |
|-----|----------------------------|--------|--------|--------|-------|-------|-------|-------|-----|
|     | 63 Hz                      | 125 Hz | 250 Hz | 500 Hz | 1K Hz | 2K Hz | 4K Hz | 8K Hz |     |
| a   | 78                         | 74     | 75     | 76     | 74    | 72    | 72    | 71    | 80  |
| b   | 74                         | 74     | 76     | 77     | 74    | 70    | 69    | 68    | 79  |
| c   | 84                         | 87     | 86     | 82     | 78    | 74    | 71    | 68    | 84  |
| d   | 92                         | 80     | 81     | 82     | 83    | 82    | 79    | 77    | 88  |
| e   | 91                         | 80     | 81     | 82     | 82    | 79    | 77    | 76    | 87  |
| f   | 89                         | 81     | 81     | 82     | 82    | 80    | 77    | 75    | 87  |

FlaktGroup India Pvt. Ltd. certifies that the 90JMC/25/6/3 series shown herein are Licensed to bear the AMCA Seal.

The ratings shown are based on tests and procedures performed in accordance with AMCA Publication 211 and AMCA Publication 311 and comply with the requirements of the AMCA Certified Ratings Program.

Performance certified is for Installation type D: Ducted Inlet- Ducted Outlet. Performance ratings do not include the effects of appurtenances (accessories)

The Sound Power Level ratings shown are in decibels, referred to  $10^{-12}$  watts, calculated per AMCA International Standard 301. Values shown are for inlet LWi and LWiA sound power levels for Installation type D: Ducted Inlet-Ducted Outlet. Ratings include the effects of duct end correction.

The A-weighted sound ratings shown have been calculated per AMCA International Standard 301.



# Fan Code: 90JMC/25/6/6/...

## 900 mm 935 rev/min 6 Blades 50 Hz



### Performance Data ISO 5801:

Performance certified is for installation type D-Ducted inlet, Ducted outlet. Performance ratings do not include the effects of appurtenances (accessories).

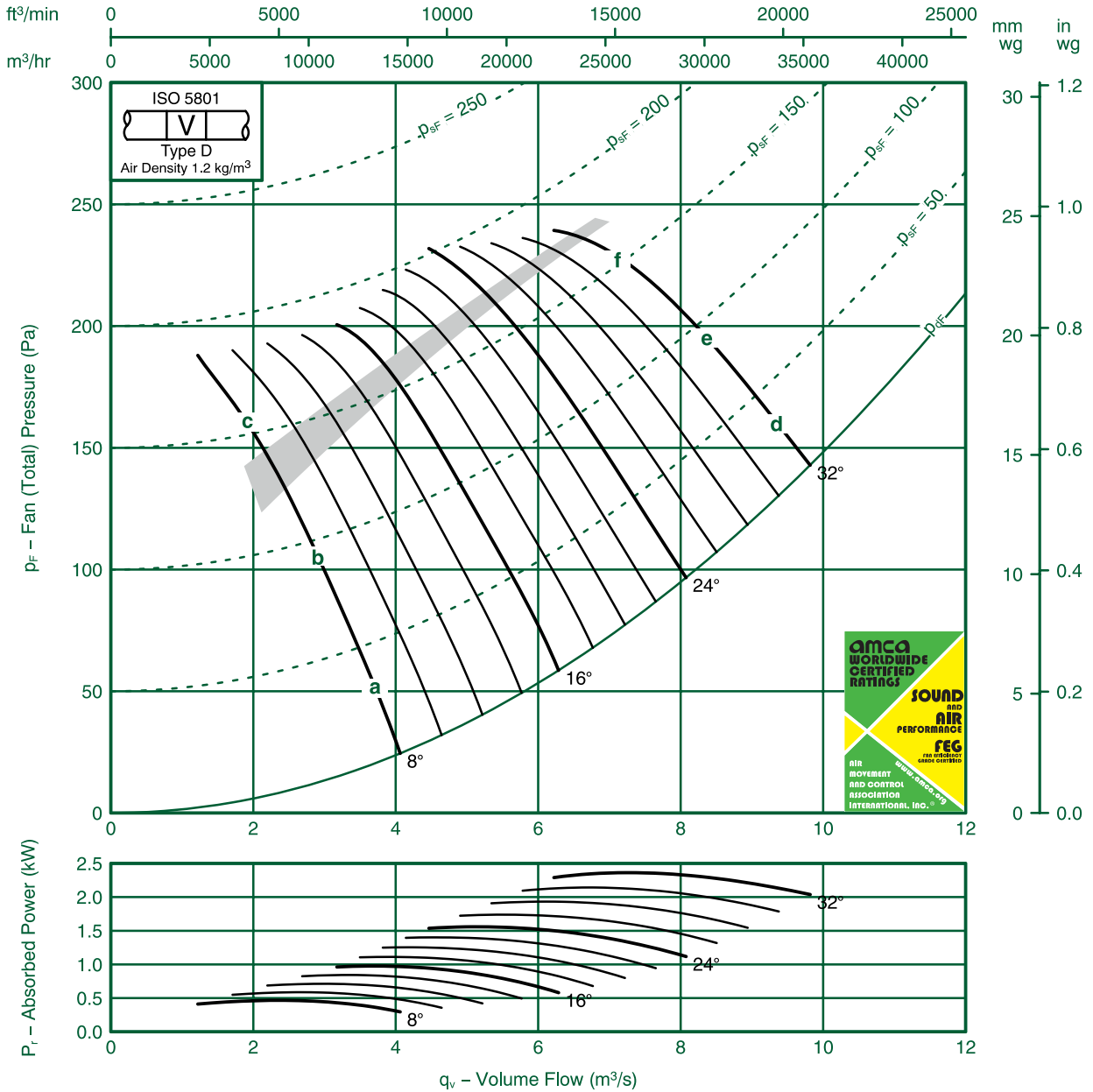

| Ref | FULL OCTAVE BAND FREQUENCY |        |        |        |       |       |       |       | LWA |
|-----|----------------------------|--------|--------|--------|-------|-------|-------|-------|-----|
|     | 63 Hz                      | 125 Hz | 250 Hz | 500 Hz | 1K Hz | 2K Hz | 4K Hz | 8K Hz |     |
| a   | 76                         | 77     | 81     | 83     | 80    | 77    | 75    | 73    | 85  |
| b   | 78                         | 81     | 86     | 86     | 82    | 78    | 74    | 70    | 87  |
| c   | 83                         | 85     | 86     | 85     | 81    | 77    | 73    | 69    | 87  |
| d   | 87                         | 84     | 86     | 85     | 83    | 81    | 79    | 77    | 89  |
| e   | 86                         | 84     | 86     | 86     | 85    | 83    | 80    | 77    | 90  |
| f   | 95                         | 95     | 94     | 91     | 87    | 82    | 78    | 74    | 93  |

FlaktGroup India Pvt. Ltd. certifies that the 90JMC/25/6/6 series shown herein are Licensed to bear the AMCA Seal.

The ratings shown are based on tests and procedures performed in accordance with AMCA Publication 211 and AMCA Publication 311 and comply with the requirements of the AMCA Certified Ratings Program.

Performance certified is for Installation type D: Ducted Inlet- Ducted Outlet. Performance ratings do not include the effects of appurtenances (accessories)

The Sound Power Level ratings shown are in decibels, referred to  $10^{-12}$  watts, calculated per AMCA International Standard 301. Values shown are for inlet LWi and LWiA sound power levels for Installation type D: Ducted Inlet-Ducted Outlet. Ratings include the effects of duct end correction.

The A-weighted sound ratings shown have been calculated per AMCA International Standard 301.



# Fan Code: 90JMC/25/4/3/...

## 900 mm 1440 rev/min 3 Blades 50 Hz



**FEG85**

**Performance Data ISO 5801:**

Performance certified is for installation type D-Ducted inlet, Ducted outlet. Performance ratings do not include the effects of appurtenances (accessories).

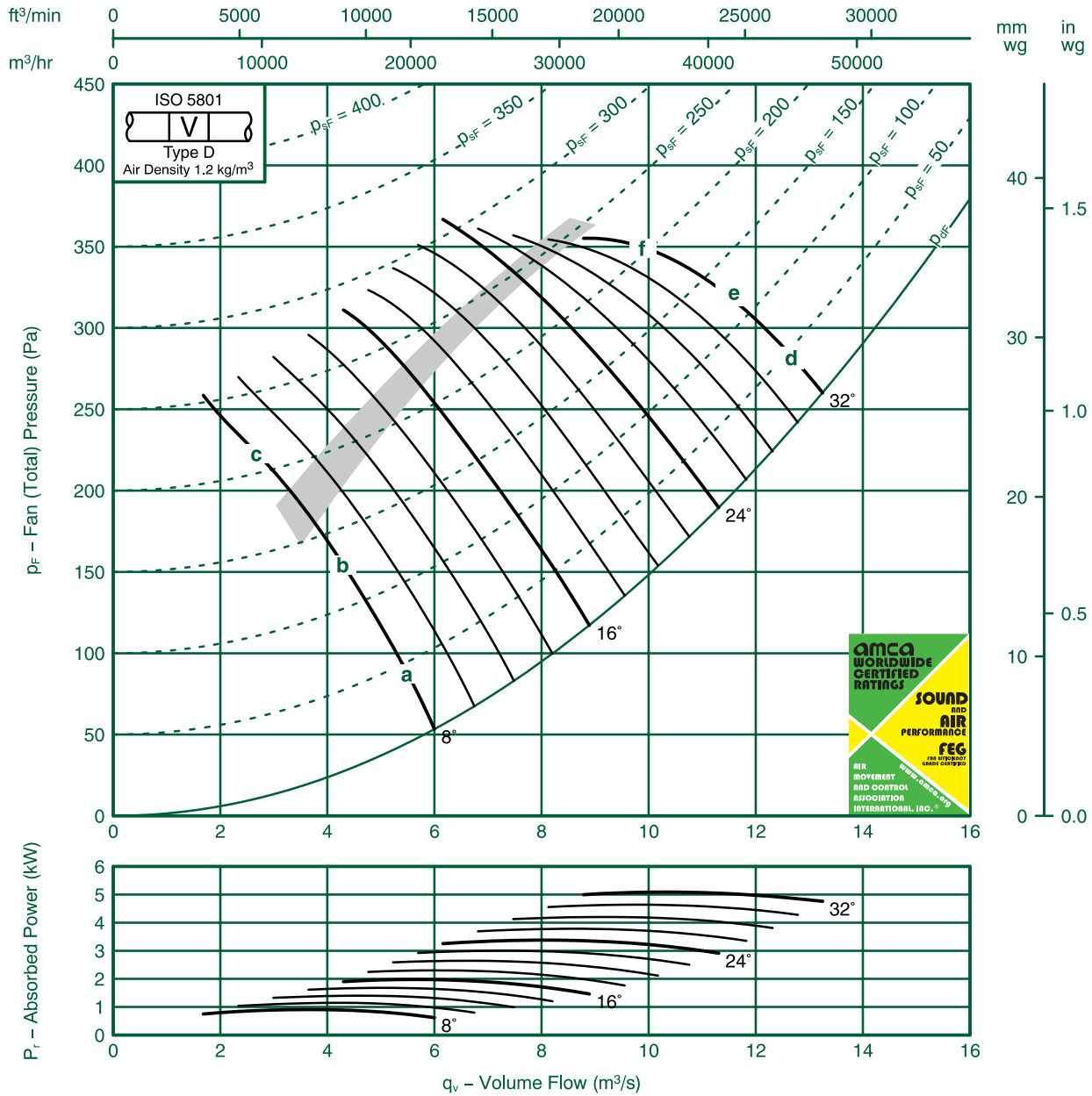

| Ref | FULL OCTAVE BAND FREQUENCY |        |        |        |       |       |       |       | LWA |
|-----|----------------------------|--------|--------|--------|-------|-------|-------|-------|-----|
|     | 63 Hz                      | 125 Hz | 250 Hz | 500 Hz | 1K Hz | 2K Hz | 4K Hz | 8K Hz |     |
| a   | 87                         | 81     | 85     | 85     | 85    | 82    | 81    | 81    | 90  |
| b   | 84                         | 80     | 85     | 86     | 86    | 81    | 79    | 78    | 90  |
| c   | 91                         | 93     | 97     | 94     | 90    | 85    | 82    | 79    | 96  |
| d   | 101                        | 90     | 91     | 92     | 92    | 92    | 88    | 87    | 98  |
| e   | 100                        | 88     | 90     | 91     | 92    | 91    | 87    | 86    | 97  |
| f   | 99                         | 90     | 91     | 92     | 92    | 91    | 87    | 85    | 97  |

FlaktGroup India Pvt. Ltd. certifies that the 90JMC/25/4/3 series shown herein are Licensed to bear the AMCA Seal.

The ratings shown are based on tests and procedures performed in accordance with AMCA Publication 211 and AMCA Publication 311 and comply with the requirements of the AMCA Certified Ratings Program.

Performance certified is for Installation type D: Ducted Inlet- Ducted Outlet. Performance ratings do not include the effects of appurtenances (accessories)

The Sound Power Level ratings shown are in decibels, referred to  $10^{-12}$  watts, calculated per AMCA International Standard 301. Values shown are for inlet LWi and LWiA sound power levels for Installation type D: Ducted Inlet-Ducted Outlet. Ratings include the effects of duct end correction.

The A-weighted sound ratings shown have been calculated per AMCA International Standard 301.



# Fan Code: 90JMC/25/4/6/...

## 900 mm 1440 rev/min 6 Blades 50 Hz



### Performance Data ISO 5801:

Performance certified is for installation type D-Ducted inlet, Ducted outlet. Performance ratings do not include the effects of appurtenances (accessories).

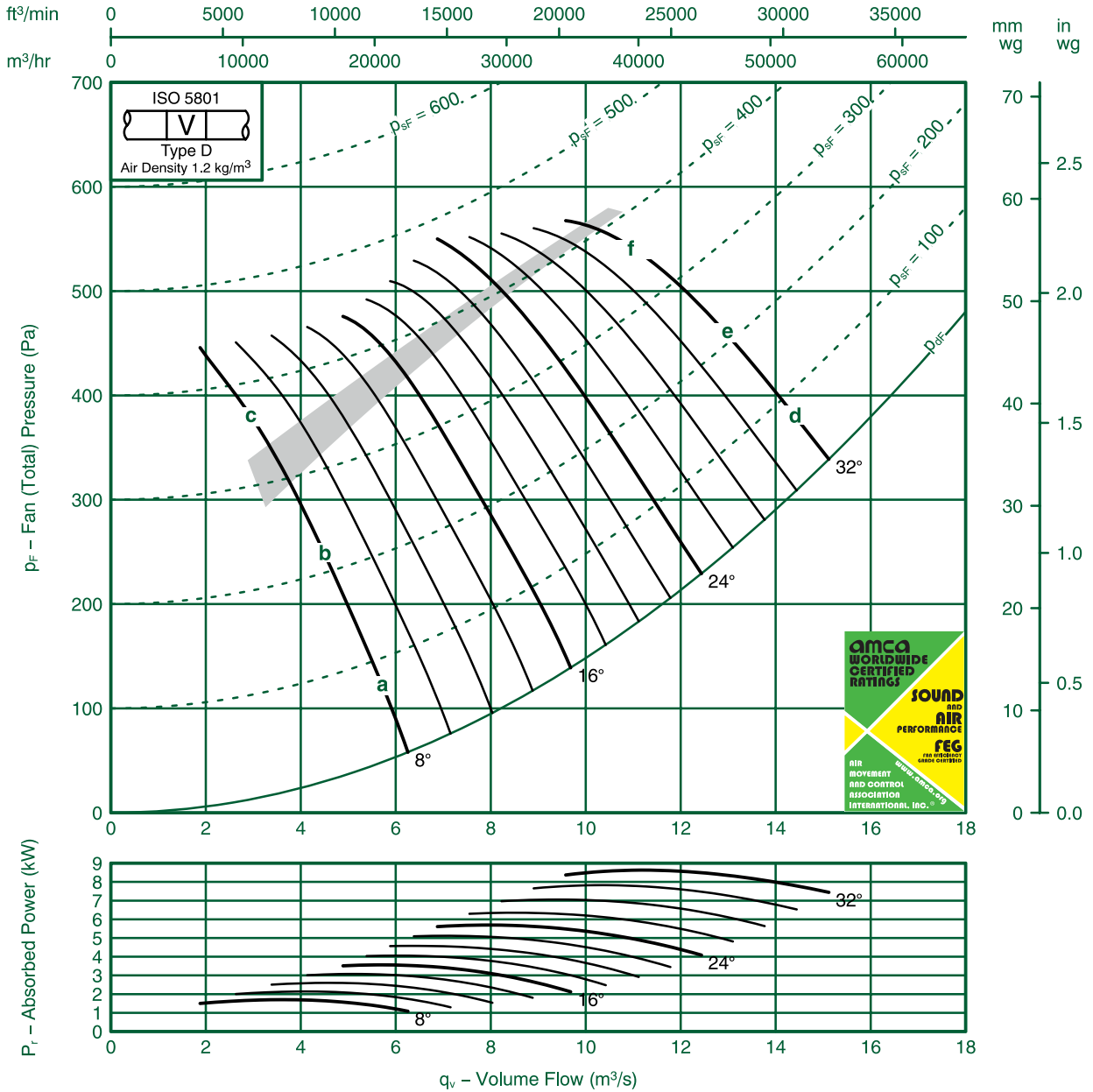

| Ref | FULL OCTAVE BAND FREQUENCY |        |        |        |       |       |       |       | LWA |
|-----|----------------------------|--------|--------|--------|-------|-------|-------|-------|-----|
|     | 63 Hz                      | 125 Hz | 250 Hz | 500 Hz | 1K Hz | 2K Hz | 4K Hz | 8K Hz |     |
| a   | 90                         | 83     | 88     | 92     | 92    | 88    | 85    | 84    | 96  |
| b   | 89                         | 86     | 93     | 96     | 95    | 90    | 85    | 82    | 99  |
| c   | 93                         | 92     | 95     | 96     | 93    | 89    | 85    | 81    | 98  |
| d   | 107                        | 90     | 95     | 95     | 94    | 92    | 90    | 88    | 99  |
| e   | 105                        | 91     | 95     | 96     | 95    | 94    | 91    | 88    | 100 |
| f   | 107                        | 104    | 105    | 103    | 99    | 95    | 89    | 85    | 104 |

FlaktGroup India Pvt. Ltd. certifies that the 90JMC/25/4/6 series shown herein are Licensed to bear the AMCA Seal.

The ratings shown are based on tests and procedures performed in accordance with AMCA Publication 211 and AMCA Publication 311 and comply with the requirements of the AMCA Certified Ratings Program.

Performance certified is for Installation type D: Ducted Inlet- Ducted Outlet. Performance ratings do not include the effects of appurtenances (accessories)

The Sound Power Level ratings shown are in decibels, referred to 10<sup>-12</sup> watts, calculated per AMCA International Standard 301. Values shown are for inlet LWi and LWiA sound power levels for Installation type D: Ducted Inlet-Ducted Outlet. Ratings include the effects of duct end correction.

The A-weighted sound ratings shown have been calculated per AMCA International Standard 301.



# Fan Code: 90JMC/25/8/9/...

## 900 mm 695 rev/min 9 Blades 50 Hz



**FEG80**

**Performance Data ISO 5801:**

Performance certified is for installation type D-Ducted inlet, Ducted outlet. Performance ratings do not include the effects of appurtenances (accessories).

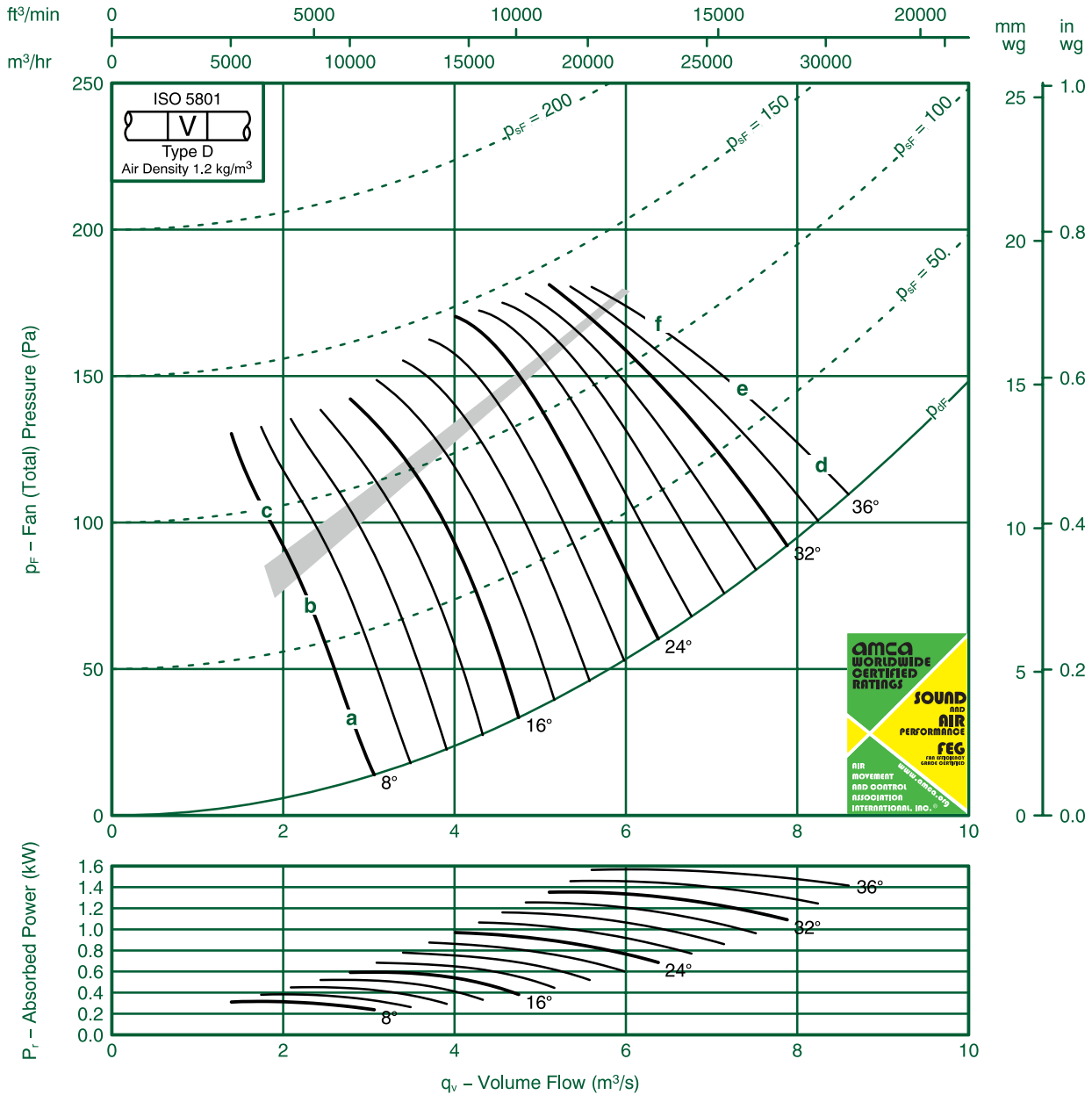

| Ref | FULL OCTAVE BAND FREQUENCY |        |        |        |       |       |       |       | LwA |
|-----|----------------------------|--------|--------|--------|-------|-------|-------|-------|-----|
|     | 63 Hz                      | 125 Hz | 250 Hz | 500 Hz | 1K Hz | 2K Hz | 4K Hz | 8K Hz |     |
| a   | 65                         | 74     | 76     | 79     | 75    | 70    | 67    | 64    | 80  |
| b   | 66                         | 74     | 78     | 82     | 77    | 70    | 65    | 60    | 82  |
| c   | 72                         | 78     | 82     | 82     | 73    | 68    | 63    | 59    | 81  |
| d   | 73                         | 81     | 82     | 80     | 75    | 72    | 70    | 69    | 81  |
| e   | 73                         | 80     | 81     | 79     | 75    | 71    | 71    | 70    | 81  |
| f   | 74                         | 80     | 80     | 78     | 75    | 72    | 71    | 70    | 81  |

FlaktGroup India Pvt. Ltd. certifies that the 90JMC/25/8/9 series shown herein are Licensed to bear the AMCA Seal.

The ratings shown are based on tests and procedures performed in accordance with AMCA Publication 211 and AMCA Publication 311 and comply with the requirements of the AMCA Certified Ratings Program.

Performance certified is for Installation type D: Ducted Inlet- Ducted Outlet. Performance ratings do not include the effects of appurtenances (accessories)

The Sound Power Level ratings shown are in decibels, referred to  $10^{-12}$  watts, calculated per AMCA International Standard 301. Values shown are for inlet LWi and LWiA sound power levels for Installation type D: Ducted Inlet-Ducted Outlet. Ratings include the effects of duct end correction.

The A-weighted sound ratings shown have been calculated per AMCA International Standard 301.



# Fan Code: 90JMC/25/6/9/... 900 mm 935 rev/min 9 Blades 50



## Performance Data ISO 5801:

Performance certified is for installation type D-Ducted inlet, Ducted outlet. Performance ratings do not include the effects of appurtenances (accessories).

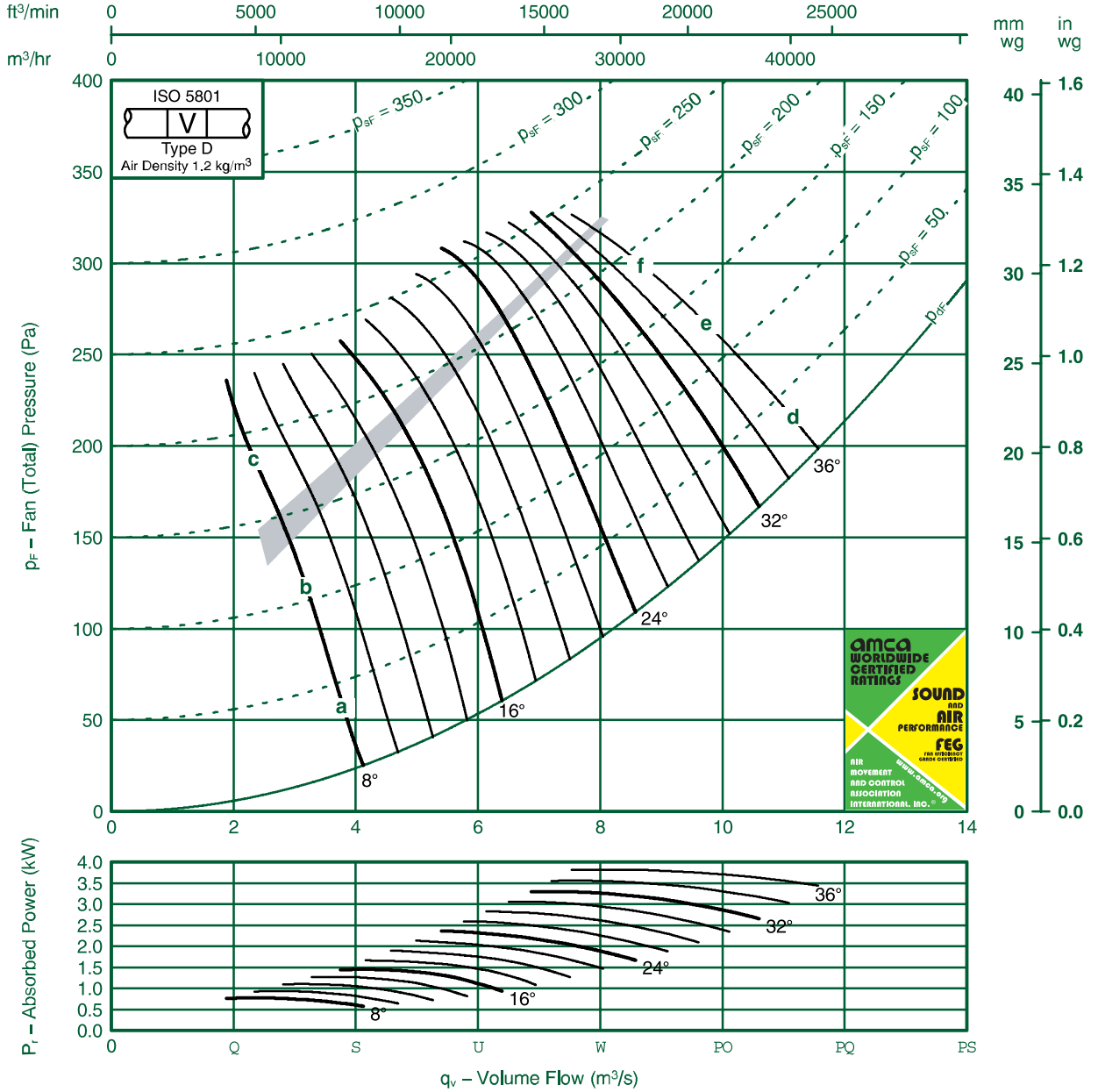

| Ref | FULL OCTAVE BAND FREQUENCY |        |        |        |       |       |       | LwA |       |
|-----|----------------------------|--------|--------|--------|-------|-------|-------|-----|-------|
|     | 63 Hz                      | 125 Hz | 250 Hz | 500 Hz | 1K Hz | 2K Hz | 4K Hz |     | 8K Hz |
| a   | 74                         | 80     | 82     | 85     | 83    | 78    | 75    | 72  | 87    |
| b   | 73                         | 80     | 83     | 88     | 86    | 79    | 73    | 68  | 89    |
| c   | 80                         | 84     | 87     | 89     | 83    | 76    | 72    | 68  | 89    |
| d   | 82                         | 87     | 88     | 87     | 83    | 79    | 77    | 76  | 89    |
| e   | 82                         | 86     | 87     | 86     | 83    | 79    | 77    | 77  | 88    |
| f   | 82                         | 86     | 87     | 86     | 83    | 79    | 78    | 77  | 88    |

FlaktGroup India Pvt. Ltd. certifies that the 90JMC/25/6/9 series shown herein are Licensed to bear the AMCA Seal.

The ratings shown are based on tests and procedures performed in accordance with AMCA Publication 211 and AMCA Publication 311 and comply with the requirements of the AMCA Certified Ratings Program.

Performance certified is for Installation type D: Ducted Inlet- Ducted Outlet. Performance ratings do not include the effects of appurtenances (accessories)

The Sound Power Level ratings shown are in decibels, referred to 10<sup>-12</sup> watts, calculated per AMCA International Standard 301. Values shown are for inlet LWi and LWiA sound power levels for Installation type D: Ducted Inlet-Ducted Outlet. Ratings include the effects of duct end correction.

The A-weighted sound ratings shown have been calculated per AMCA International Standard 301.



# Fan Code: 90JMC/25/4/9/...

## 900 mm 1440 rev/min 9 Blades 50 Hz



### Performance Data ISO 5801:

Performance certified is for installation type D-Ducted inlet, Ducted outlet. Performance ratings do not include the effects of appurtenances (accessories).

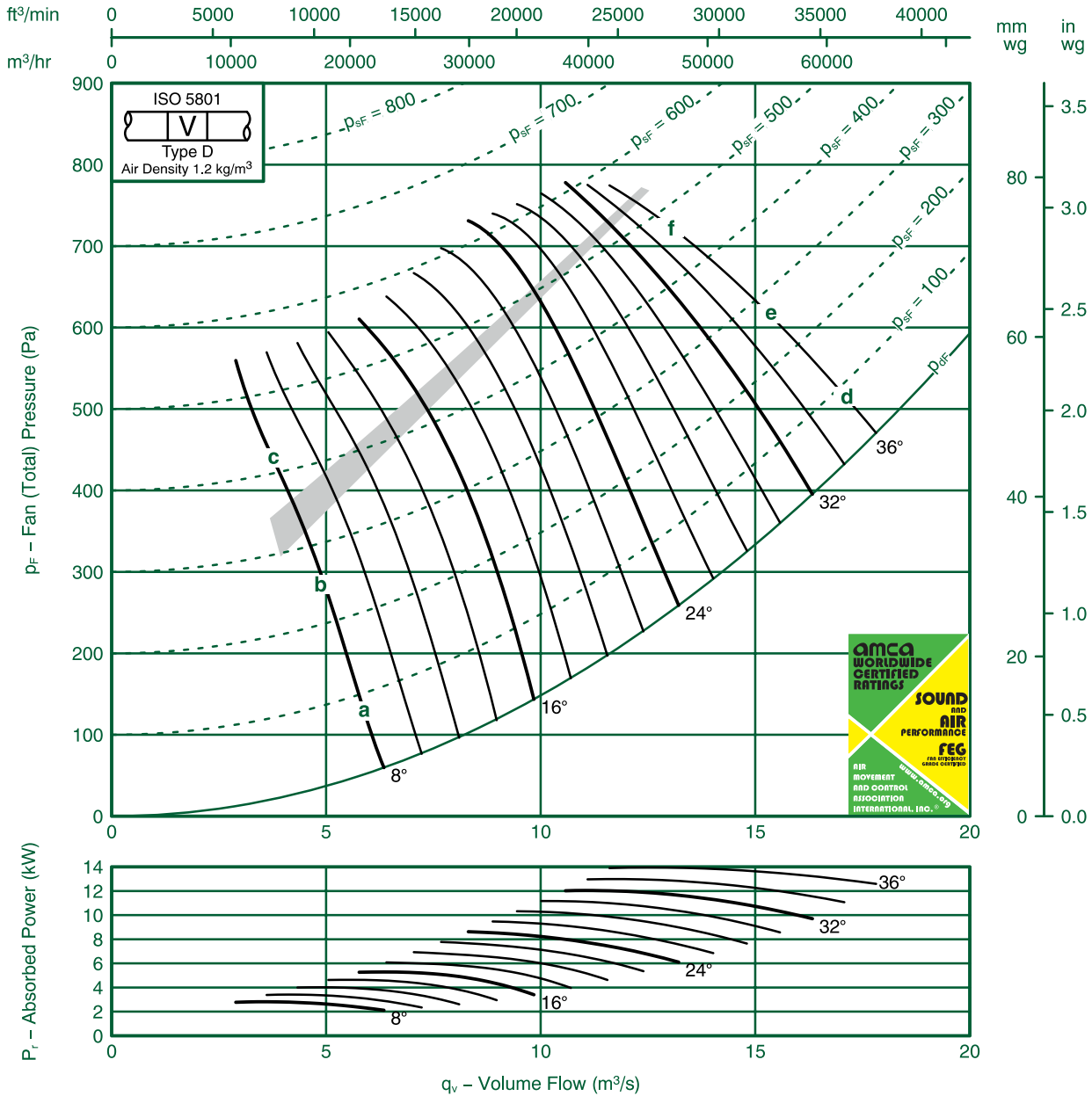

| Ref | FULL OCTAVE BAND FREQUENCY |        |        |        |       |       |       |       | LwA |
|-----|----------------------------|--------|--------|--------|-------|-------|-------|-------|-----|
|     | 63 Hz                      | 125 Hz | 250 Hz | 500 Hz | 1K Hz | 2K Hz | 4K Hz | 8K Hz |     |
| a   | 89                         | 81     | 89     | 92     | 95    | 91    | 86    | 83    | 98  |
| b   | 84                         | 82     | 89     | 94     | 98    | 94    | 86    | 81    | 101 |
| c   | 91                         | 88     | 93     | 98     | 98    | 89    | 84    | 80    | 100 |
| d   | 97                         | 89     | 97     | 98     | 96    | 91    | 87    | 86    | 100 |
| e   | 97                         | 88     | 96     | 97     | 95    | 91    | 87    | 87    | 99  |
| f   | 96                         | 89     | 96     | 96     | 94    | 91    | 87    | 87    | 99  |

FlaktGroup India Pvt. Ltd. certifies that the 90JMC/25/4/9 series shown herein are Licensed to bear the AMCA Seal.

The ratings shown are based on tests and procedures performed in accordance with AMCA Publication 211 and AMCA Publication 311 and comply with the requirements of the AMCA Certified Ratings Program.

Performance certified is for Installation type D: Ducted Inlet- Ducted Outlet. Performance ratings do not include the effects of appurtenances (accessories)

The Sound Power Level ratings shown are in decibels, referred to 10<sup>-12</sup> watts, calculated per AMCA International Standard 301. Values shown are for inlet LWi and LWiA sound power levels for Installation type D: Ducted Inlet-Ducted Outlet. Ratings include the effects of duct end correction.

The A-weighted sound ratings shown have been calculated per AMCA International Standard 301.



# Fan Code: 160JMC/40/12/6/...

## 1600 mm 480 rev/min 6 Blades 50 Hz



### Performance Data ISO 5801:

Performance certified is for installation type C-Ducted inlet, Free outlet. Performance ratings do not include the effects of appurtenances (accessories).

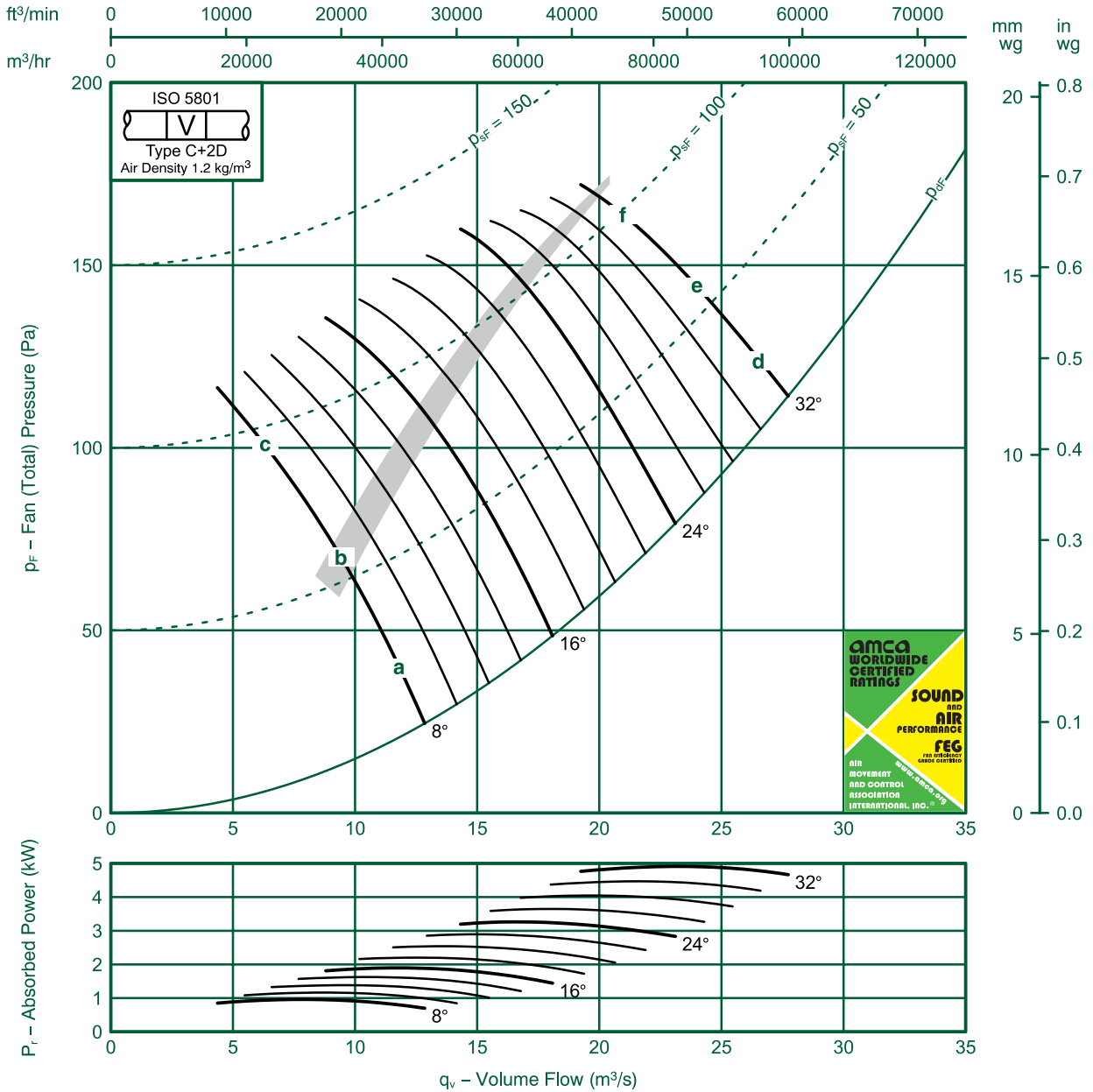

| Ref | FULL OCTAVE BAND FREQUENCY |        |        |        |       |       |       |       | LWA |
|-----|----------------------------|--------|--------|--------|-------|-------|-------|-------|-----|
|     | 63 Hz                      | 125 Hz | 250 Hz | 500 Hz | 1K Hz | 2K Hz | 4K Hz | 8K Hz |     |
| a   | 77                         | 81     | 83     | 82     | 77    | 74    | 71    | 67    | 83  |
| b   | 80                         | 81     | 79     | 77     | 75    | 72    | 67    | 59    | 80  |
| c   | 77                         | 79     | 77     | 76     | 75    | 72    | 67    | 60    | 79  |
| d   | 86                         | 87     | 86     | 85     | 83    | 80    | 76    | 73    | 88  |
| e   | 90                         | 92     | 92     | 88     | 85    | 80    | 76    | 72    | 90  |
| f   | 98                         | 101    | 97     | 91     | 85    | 79    | 74    | 70    | 93  |

FlaktGroup India Pvt. Ltd. certifies that the 160JMC/40/12/6 series shown herein are Licensed to bear the AMCA Seal.

The ratings shown are based on tests and procedures performed in accordance with AMCA Publication 211 and AMCA Publication 311 and comply with the requirements of the AMCA Certified Ratings Program.

Performance certified is for Installation type C: Ducted Inlet-Free Outlet. Performance ratings do not include the effects of appurtenances (accessories)

The Sound Power Level ratings shown are in decibels, referred to  $10^{-12}$  watts, calculated per AMCA International Standard 301. Values shown are for inlet LWi and LWIA sound power levels for Installation type C: Ducted Inlet-Free Outlet. Ratings include the effects of duct end correction.

The A-weighted sound ratings shown have been calculated per AMCA International Standard 301.





# Fan Code: 160JMC/40/10/6/... 1600 mm 575 rev/min 6 Blades 50 Hz



### Performance Data ISO 5801:

Performance certified is for installation type C-Ducted inlet, Free outlet. Performance ratings do not include the effects of appurtenances (accessories).

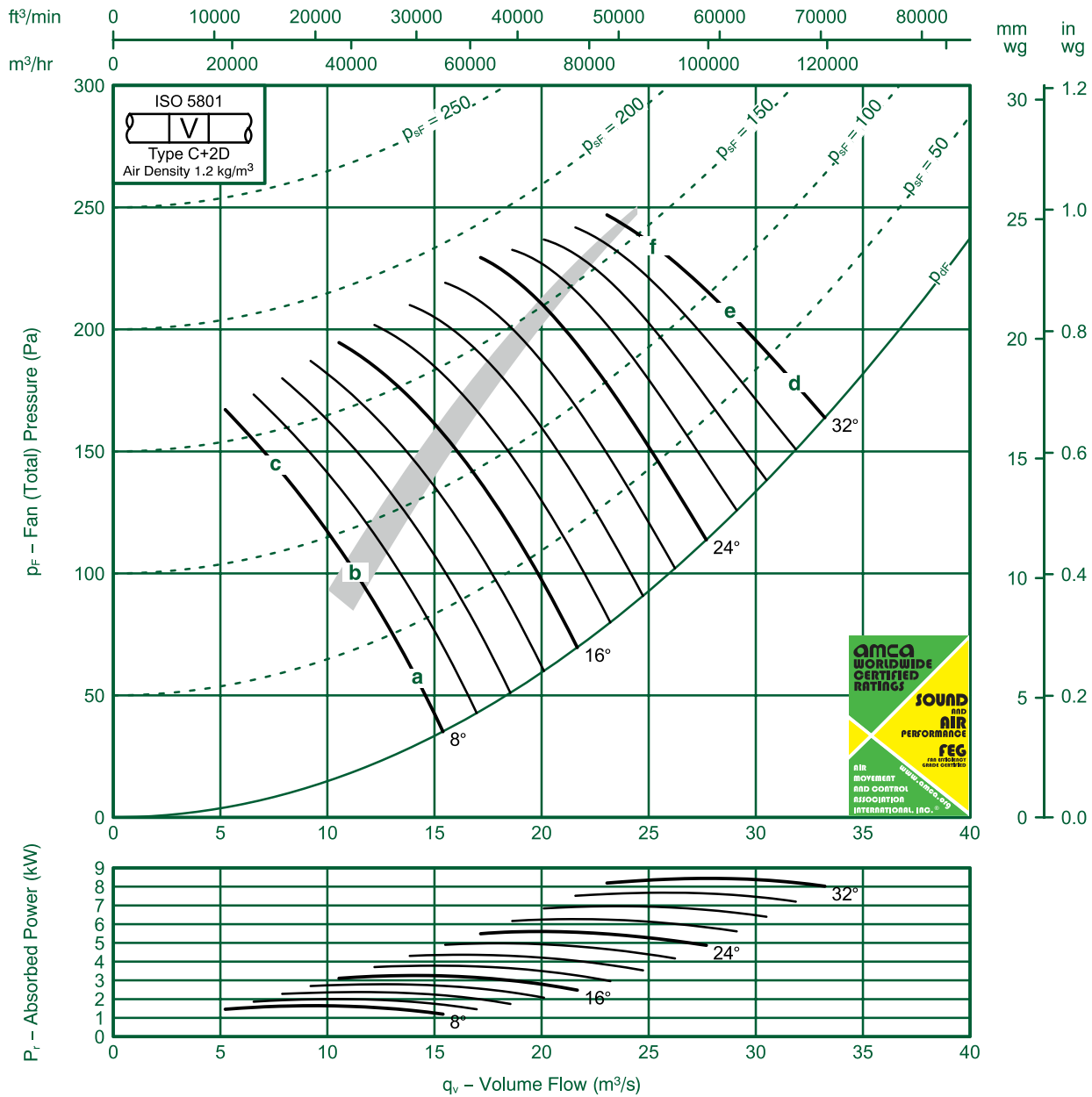

| Ref | FULL OCTAVE BAND FREQUENCY |        |        |        |       |       |       |       | LWA |
|-----|----------------------------|--------|--------|--------|-------|-------|-------|-------|-----|
|     | 63 Hz                      | 125 Hz | 250 Hz | 500 Hz | 1K Hz | 2K Hz | 4K Hz | 8K Hz |     |
| a   | 80                         | 84     | 87     | 86     | 83    | 79    | 77    | 72    | 88  |
| b   | 83                         | 86     | 83     | 81     | 80    | 77    | 72    | 65    | 84  |
| c   | 78                         | 83     | 81     | 80     | 79    | 77    | 72    | 65    | 84  |
| d   | 90                         | 91     | 91     | 89     | 87    | 85    | 81    | 77    | 92  |
| e   | 89                         | 95     | 96     | 94     | 90    | 86    | 81    | 78    | 96  |
| f   | 99                         | 106    | 102    | 96     | 91    | 85    | 79    | 75    | 99  |

FlaktGroup India Pvt. Ltd. certifies that the 160JMC/40/10/6 series shown herein are Licensed to bear the AMCA Seal.

The ratings shown are based on tests and procedures performed in accordance with AMCA Publication 211 and AMCA Publication 311 and comply with the requirements of the AMCA Certified Ratings Program.

Performance certified is for Installation type C: Ducted Inlet-Free Outlet. Performance ratings do not include the effects of appurtenances (accessories)

The Sound Power Level ratings shown are in decibels, referred to  $10^{-12}$  watts, calculated per AMCA International Standard 301. Values shown are for inlet LWi and LWiA sound power levels for Installation type C: Ducted Inlet-Free Outlet. Ratings include the effects of duct end correction.

The A-weighted sound ratings shown have been calculated per AMCA International Standard 301.



# Fan Code: 160JMC/40/8/6/...

## 1600 mm 720 rev/min 6 Blades 50 Hz



### Performance Data ISO 5801:

Performance certified is for installation type C-Ducted inlet, Free outlet. Performance ratings do not include the effects of appurtenances (accessories).

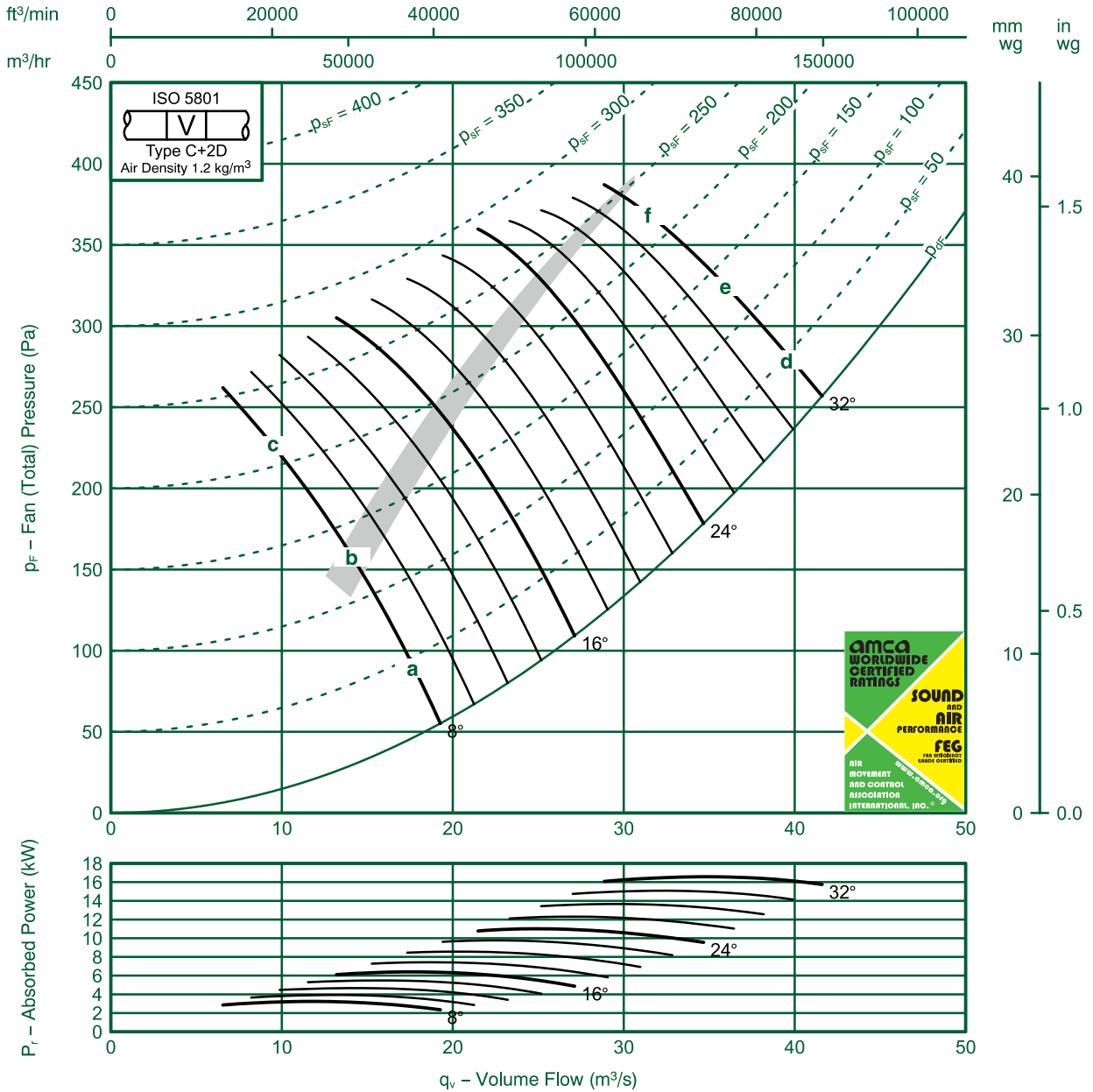

| Ref | FULL OCTAVE BAND FREQUENCY |        |        |        |       |       |       | LWA |       |
|-----|----------------------------|--------|--------|--------|-------|-------|-------|-----|-------|
|     | 63 Hz                      | 125 Hz | 250 Hz | 500 Hz | 1K Hz | 2K Hz | 4K Hz |     | 8K Hz |
| a   | 89                         | 93     | 92     | 89     | 87    | 82    | 82    | 74  | 92    |
| b   | 85                         | 91     | 89     | 87     | 86    | 83    | 80    | 73  | 91    |
| c   | 80                         | 89     | 86     | 85     | 85    | 83    | 79    | 72  | 89    |
| d   | 93                         | 96     | 96     | 95     | 93    | 91    | 87    | 83  | 98    |
| e   | 92                         | 97     | 100    | 100    | 96    | 92    | 87    | 84  | 101   |
| f   | 100                        | 112    | 109    | 103    | 98    | 91    | 85    | 81  | 105   |

FlaktGroup India Pvt. Ltd. certifies that the 160JMC/40/8/6 series shown herein are Licensed to bear the AMCA Seal.

The ratings shown are based on tests and procedures performed in accordance with AMCA Publication 211 and AMCA Publication 311 and comply with the requirements of the AMCA Certified Ratings Program.

Performance certified is for Installation type C: Ducted Inlet-Free Outlet. Performance ratings do not include the effects of appurtenances (accessories)

The Sound Power Level ratings shown are in decibels, referred to  $10^{-12}$  watts, calculated per AMCA International Standard 301. Values shown are for inlet LWi and LWiA sound power levels for Installation type C: Ducted Inlet-Free Outlet. Ratings include the effects of duct end correction.

The A-weighted sound ratings shown have been calculated per AMCA International Standard 301.



# Fan Code: 160JMC/40/6/6/...

## 1600 mm 960 rev/min 6 Blades 50 Hz



### Performance Data ISO 5801:

Performance certified is for installation type C-Ducted inlet, Free outlet. Performance ratings do not include the effects of appurtenances (accessories).

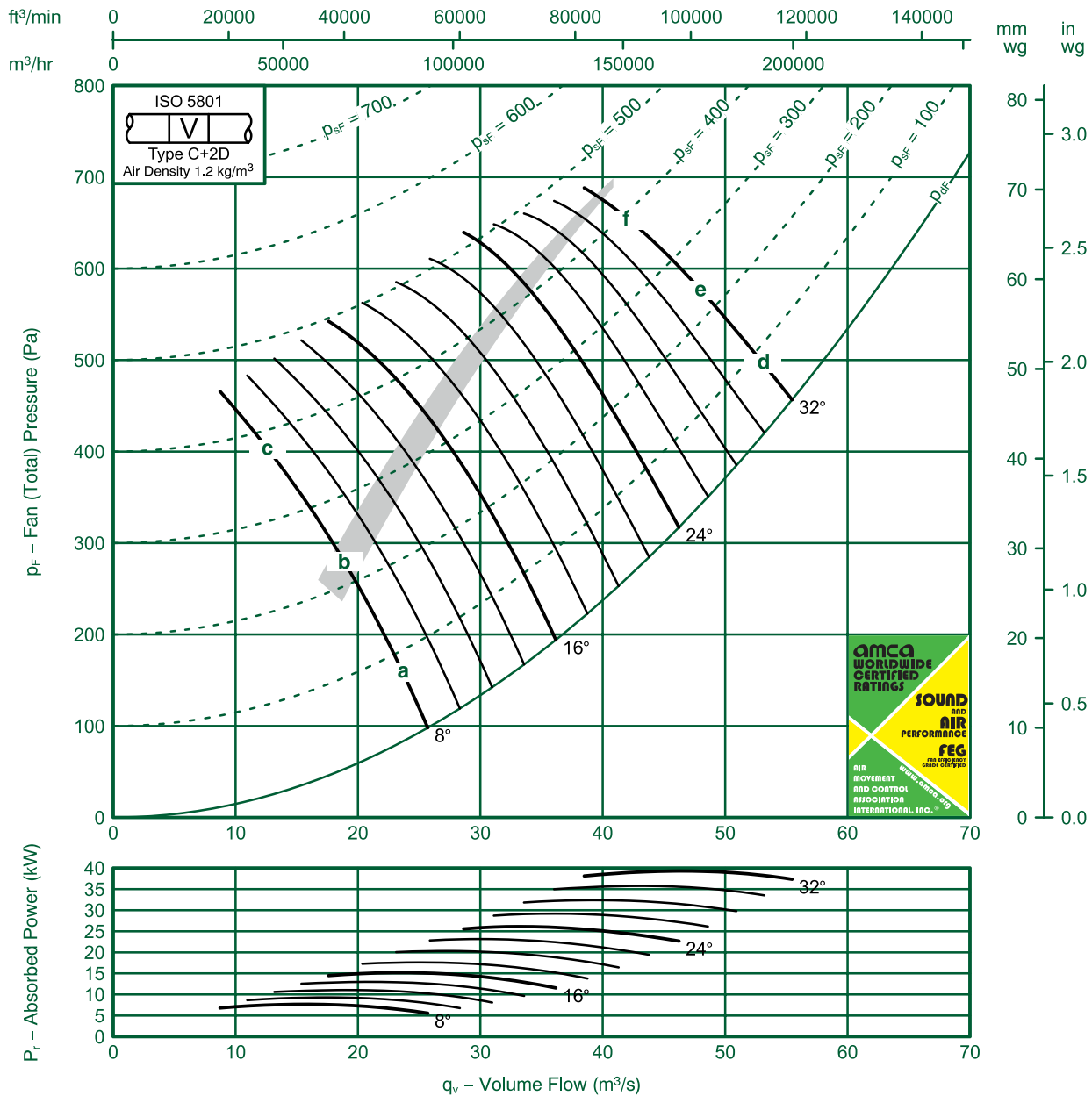

| Ref | FULL OCTAVE BAND FREQUENCY |        |        |        |       |       |       |       | LWA |
|-----|----------------------------|--------|--------|--------|-------|-------|-------|-------|-----|
|     | 63 Hz                      | 125 Hz | 250 Hz | 500 Hz | 1K Hz | 2K Hz | 4K Hz | 8K Hz |     |
| a   | 89                         | 95     | 96     | 98     | 97    | 92    | 90    | 86    | 101 |
| b   | 91                         | 95     | 96     | 94     | 92    | 90    | 87    | 82    | 98  |
| c   | 86                         | 92     | 93     | 91     | 91    | 90    | 87    | 82    | 96  |
| d   | 99                         | 102    | 102    | 102    | 100   | 98    | 94    | 90    | 105 |
| e   | 99                         | 101    | 105    | 106    | 104   | 100   | 95    | 91    | 108 |
| f   | 106                        | 114    | 117    | 112    | 106   | 100   | 94    | 89    | 113 |

FlaktGroup India Pvt. Ltd. certifies that the 160JMC/40/6/6 series shown herein are Licensed to bear the AMCA Seal.

The ratings shown are based on tests and procedures performed in accordance with AMCA Publication 211 and AMCA Publication 311 and comply with the requirements of the AMCA Certified Ratings Program.

Performance certified is for Installation type C: Ducted Inlet-Free Outlet. Performance ratings do not include the effects of appurtenances (accessories)

The Sound Power Level ratings shown are in decibels, referred to  $10^{-12}$  watts, calculated per AMCA International Standard 301. Values shown are for inlet LWi and LWiA sound power levels for Installation type C: Ducted Inlet-Free Outlet. Ratings include the effects of duct end correction.

The A-weighted sound ratings shown have been calculated per AMCA International Standard 301.



## Dimensions and Weights 710 - 900 DIA -UP TO 315 HUB

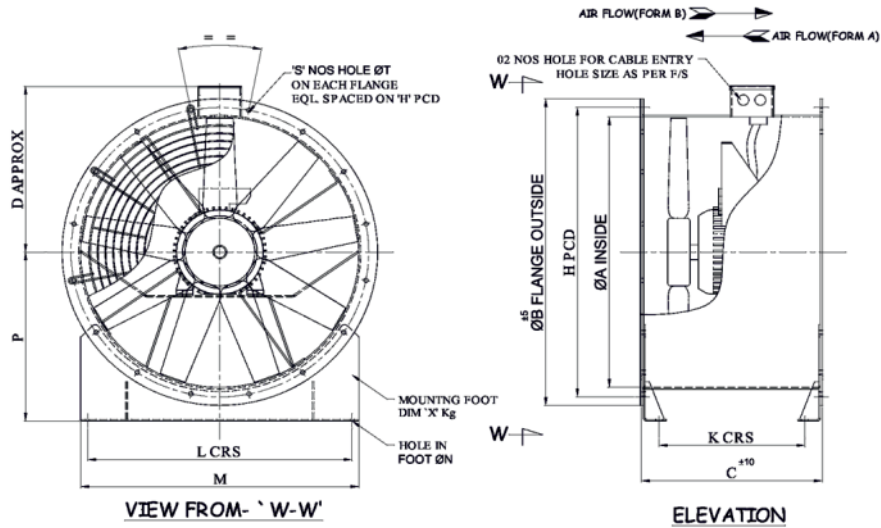

| CODE | MOTOR RATING (KW) | A   | B    | C   | D   | H   | K   | L   | M   | N  | P   | S  | T  | X (kg) | FAN WT. (KG) |
|------|-------------------|-----|------|-----|-----|-----|-----|-----|-----|----|-----|----|----|--------|--------------|
| 710  | 0.75              | 710 | 804  | 375 | 443 | 770 | 259 | 660 | 710 | 10 | 440 | 16 | 12 | 4.5    | 54           |
|      | 2.2               | 710 | 804  | 520 | 443 | 770 | 404 | 660 | 710 | 10 | 440 | 16 | 12 | 4.5    | 85           |
|      | 7.5               | 710 | 804  | 520 | 480 | 770 | 402 | 660 | 710 | 12 | 440 | 16 | 12 | 5.3    | 139          |
|      | 15                | 710 | 804  | 625 | 480 | 770 | 505 | 660 | 710 | 10 | 440 | 16 | 12 | 5.3    | 205          |
|      | 22                | 710 | 804  | 711 | 480 | 770 | 589 | 660 | 710 | 16 | 440 | 16 | 12 | 7.4    | 280          |
| 800  | 0.75              | 800 | 894  | 375 | 488 | 860 | 259 | 750 | 800 | 10 | 510 | 16 | 12 | 7      | 63           |
|      | 2.2               | 800 | 894  | 520 | 488 | 860 | 404 | 750 | 800 | 10 | 510 | 16 | 12 | 7      | 94           |
|      | 7.5               | 800 | 894  | 520 | 525 | 860 | 400 | 750 | 800 | 12 | 510 | 16 | 12 | 7      | 163          |
|      | 15                | 800 | 894  | 625 | 525 | 860 | 499 | 750 | 800 | 12 | 510 | 16 | 12 | 7      | 220          |
|      | 22                | 800 | 894  | 711 | 525 | 860 | 589 | 750 | 800 | 12 | 510 | 16 | 12 | 8.5    | 300          |
| 900  | 2.2               | 900 | 1006 | 520 | 538 | 970 | 444 | 850 | 900 | 10 | 518 | 16 | 15 | 4.5    | 99           |
|      | 7.5               | 900 | 1006 | 520 | 575 | 970 | 444 | 850 | 900 | 12 | 518 | 16 | 15 | 4.5    | 183          |
|      | 15                | 900 | 1006 | 625 | 575 | 970 | 539 | 850 | 900 | 12 | 518 | 16 | 15 | 4.5    | 252          |



## Dimensions and Weights

### 1600 DIA - UP TO 500 HUB



| CODE | MOTOR RATING (KW) | A    | B    | C    | D   | H    | K   | L    | M    | N  | P    | S  | T  | X (kg) | FAN WT. (KG) |         |
|------|-------------------|------|------|------|-----|------|-----|------|------|----|------|----|----|--------|--------------|---------|
|      |                   |      |      |      |     |      |     |      |      |    |      |    |    |        | 400 HUB      | 500 HUB |
| 1600 | 7.5               | 1600 | 1760 | 610  | 930 | 1680 | 468 | 1500 | 1600 | 14 | 1006 | 24 | 20 | 40.7   | 354          | 374     |
|      | 15                | 1600 | 1760 | 750  | 930 | 1680 | 608 | 1500 | 1600 | 14 | 1000 | 24 | 20 | 40.7   | 476          | 494     |
|      | 22                | 1600 | 1760 | 800  | 930 | 1680 | 658 | 1500 | 1600 | 14 | 1000 | 24 | 20 | 40.7   | 642          | 661     |
|      | 30                | 1600 | 1760 | 900  | 988 | 1680 | 758 | 1500 | 1600 | 14 | 1000 | 24 | 20 | 40.7   | 723          | 741     |
|      | 45                | 1600 | 1760 | 950  | 988 | 1680 | 808 | 1500 | 1600 | 14 | 1000 | 24 | 20 | 40.7   | 758          | 777     |
|      | 55                | 1600 | 1760 | 1050 | 988 | 1680 | 908 | 1500 | 1600 | 14 | 1000 | 24 | 20 | 40.7   | 973          | 993     |

All dimensions are in mm.

**Note:** Due to a policy of continuous development and improvement the right is reserved to supply products which may differ from those illustrated and described in this publication. Certified dimensions will be supplied on request on receipt of order.

# Advanced Selection Tools

## Computational Fluid Dynamics (CFD)

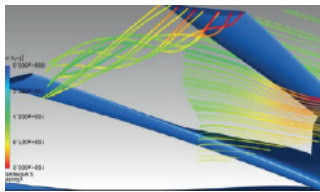

Airflow behaviour is difficult and complicated to predict, especially in large spaces such as car parks. Accurate calculations are therefore paramount when creating an effective ventilation system. FläktGroup modelling is backed up with both lab test research and smoke tests in real car parks to insure accuracy.

Manual calculations methods used by many as their sole solution are extremely limited. At FläktGroup we therefore offer a full CFD analysis to customers on all projects to prove our solution.

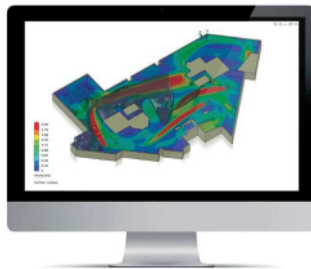

## FläktGroup World Class Fan Selector Program

Extended features for efficient Fan Selection. The FläktGroup Fan Selector is probably the most comprehensive tool of its kind in the world. The software has been developed based on many years experience of producing fan selection tools.

The Fan Selector Tool is available to all customers and prospects. To get access you need only a browser with an Internet connection. The tool can be configured with your own preferences (Language, metric, LCC calculation set up, currency, etc). The tool currently includes a large number of the FläktGroup axial fans, centrifugal fans, box and duct fans, and our Energy Recovery Units.



## FläktGroup India Pvt Ltd - Your local expert

At FlaktGroup India we offer expert knowledge and manufacturing since our establishment in the 1950s. Not only do we sell Air Movement products such as fans for fire safety and normal ventilation applications, we have the advantage of being a manufacturer of highly efficient AHUs and are in the unique position of offering both Air Movement and Air Treatment product families.

Our fully integrated state of art manufacturing facility has over 10,000 m<sup>2</sup> capacity. For the first time in India, we have introduced capabilities of manufacturing all AHU components in house. FlaktGroup has the facilities to satisfy our customers' needs.

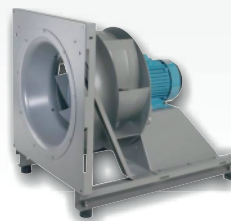

## WE BRING **BETTER AIR**<sup>™</sup> TO LIFE

FlaktGroup is a global leader for indoor Air Comfort and Fire Safety. We specialize in the design and manufacturing of a wide range of products, systems and components to provide the best performances and maximum energy efficiency. Our product brands such as SEMCO®, eQ®, eQ Prime®, JM Aerofoil®, Econet®, Veloduct®, Optivent®, Optimix®, Econovent® and Cleanvent® are well known and trusted by customers all over the world to deliver best Air Comfort and Fire Safety.

Our collective experience is unrivalled for every customer application like Offices, Hygiene, Hotels, Public Buildings, Education, Car Parks, Retails, Green Buildings, Marine, Oil & Gas. and others.

WWW.FLAKTWOODS.IN

JMC AEROFOIL FAN RANGE | 95596B



### FlaktGroup India Pvt Ltd

Unit-1 : Plot 87, Ecotech-1, Extension-1, Gr. Noida 210308 (UP) | Phone : +91 120 6433600 | Email : tssindia@flaktgroup.com

FlaktGroup Limited | Centre of Excellence - Axial Fans | Axial Way, Colchester, Essex, CO4 5ZD | tel: 01206 222 555 | fax: 01206 222 777  
email: info.uk@flaktgroup.com | website: www.flaktgroup.com