

VANEAXIAL FANS, TYPE "P"



MODELS: VP / VPBD





Model VP
Arrangement 4



Model VPBD
Arrangement 9

Sizes and Performance

- 12" to 60" impeller diameters
- Airflow to 103,000 CFM
- Static pressure to 5.5" w.g.
- 37 unique diameters and hub-to-tip ratios



Models VP/VPBD is available with UL/cUL 705 listing for electrical, File No. E158680.



Aerovent, a Twin City Fan Company, certifies that the Model VP and VPBD Vaneaxial fans shown herein are licensed to bear the AMCA Seal. Certified performance data may be found in Aerovent's Fan Selector software.



Scan the QR code to search Aerovent's AMCA-certified products.

Overview

VP | VPBD

The Model VP/VPBD Type "P", vaneaxial fan is ideal for installation in hospitals, schools, research labs, fume exhaust systems and high moisture areas. The fan housing is fitted with aerodynamically designed, stationary straightening guide vanes on the air discharge side of the impeller. The guide vanes are welded to both the inner cylinder and the fan housing interior. The vanes function to aid in the elimination of swirl and turbulence downstream of the fan, thereby recovering rotational energy losses, improving efficiency and static pressure capability, and reducing fan noise generation.

The Type "P" Vaneaxial Fans from Aerovent are designed to handle a wide range of requirements, from general ventilation to process air supply. Its mounting flexibility, which allows it to be mounted as part of the ductwork, makes it ideal for many industrial and commercial applications.

Typical Applications Include

Data Center Exhaust, General HVAC, Generator Room Ventilation, Swimming Pool Exhaust, Kitchen Exhaust, Dishwasher Exhaust, Elevator Shaft Exhaust/Pressurization, Emergency Smoke Exhaust, Stairwell Pressurization

Configurations

Direct and Belt Driven - vertical and horizontal mount configurations

Impeller Type

Aluminum

Optional Construction

Clamshell Construction, Swingout Construction, AMCA Type A or B Spark Resistant Construction, High Moisture Modification, High Temperature Construction (up to 250°F)

Certifications

AMCA Air / FEI and UL 705 Listed for Electrical



For complete product performance, drawings and available accessories, download our Fan Selector software at aerovent.com.

Applications

VP | VPBD

Ventilation

Whether duct mounted or provided with an inlet bell for open inlets, the VP/VPBD Type "P" is the logical choice for almost any ventilating system. Available as either a supply or return fan, the magnitude of fan/impeller combinations to choose from ensures the user of a high efficient, economical, quiet, long-running fan.

Industrial Process

Designed for rugged industrial service, the VP/VPBD Type "P" is an ideal component for most industrial air systems. The heavy-duty housing construction and large diameter shaft/bearing combinations can handle the toughest of airstreams.

Uplast Style Power Roof Ventilator

Fitted with a stack cap, curb cap and a weather cover, the VP/VPBD Type "P" makes an ideal upblast style power roof ventilator. The broad band high efficiency range makes this fan ideal for installation both with and without ductwork attached.

Easy Access Fans

Our clamshell design was crafted to minimize downtime in applications requiring frequent cleaning. Need the ability to perform maintenance too? Our swingout design provides unparalleled accessibility to critical components, such as the shaft, bearings, V-belt drive and impeller assembly, all without the hassle of ductwork removal to fit all of your maintenance and cleaning needs. See more about how our designs provide you value on page 5.

Energy Regulations

Aerovent supports energy efficiency regulations enacted by the U.S. Department of Energy (DOE) and specific states. The selection and application of fan products is a significant part of these regulations. Engineers and specifiers must understand how to apply Aerovent products to their specific applications to meet applicable DOE and state regulatory requirements. Aerovent has made significant investments in product testing and development to provide efficient products. Developments in Aerovent's Fan Selector software are in place to aid your decision in product selection to assist with meeting the efficiency requirements as stipulated in the applicable regulations.

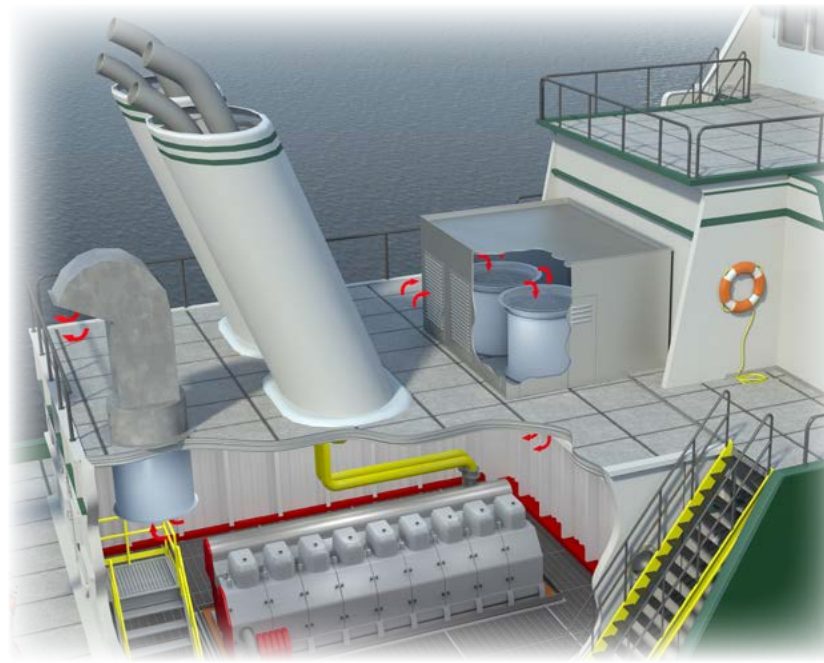

Engine Room Exhaust

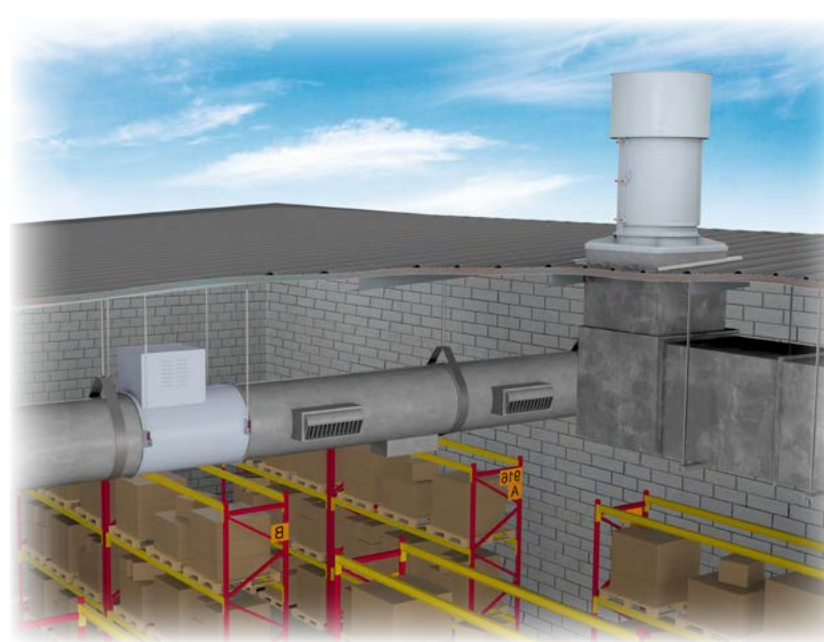

Warehouse Application with VRM & HCH Fans

Housing

Housings are one-piece, heavy-gauge, hot-rolled steel construction. Flanges on both the inlet and outlet are integrally rolled and punched for attachment to ductwork or accessories as necessary. The sheet seam is continuously-welded and ground smooth to assure efficient airflow through the housing. On Arrangement 4 direct drive units neither the impeller nor the motor protrudes beyond the housing, allowing for an easy mount into existing ductwork.

Impeller

The heart of the Type "P" fans lies in its impeller. Cast of high strength aluminum alloy, the one-piece impeller has been developed to maximize the highest efficiency possible. Attention to detail in blade and hub design have created what is felt to be the most efficient and reliable axial fan on the market today. With the wide range of hub-to-tip ratios available, there is a fan to meet any air movement requirement.

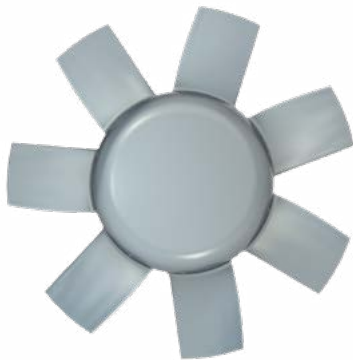

Guide Vanes

The fan housing is fitted with aerodynamically designed stationary straightening guide vanes on the air discharge side of the impeller. The guide vanes are welded to both the inner cylinder and the fan housing interior and function to aid in the elimination of swirl and turbulence downstream of the fan thereby recovering rotational energy losses, improving efficiency and static pressure capability and reducing fan noise generation.

Belt Fairing

The V-belt drive assembly is extended through a two-piece belt fairing. The belt fairing is an aerodynamically designed tube, welded continuously to both the inner cylinder (bearing housing) and the fan housing, thus protecting the V-belts from the direct blast of the airstream.

Hub-To-Tip Ratio

The multitude of impellers evolves from nine basic castings. Each casting is machined and cut to the proper diameter. By cutting the same model casting to one of several different diameters, different hub-to-tip ratios are created. Since each hub ratio has slightly different pressure/efficiency characteristics, the freedom of having several impellers (different hub ratios) for a set diameter provides the opportunity to maximize efficiency at the required point of rating.

Shaft and Bearings/Inner Cylinder

Shafts for belt driven units are ground and polished steel construction machined to a suitable diameter to allow the rotating assembly to operate well below the first critical speed.

Bearings are ball or roller type selected for a minimum average life of 200,000 hours. Bearing life is determined in accordance with standards set forth by AFBMA (Anti-Friction Bearing Manufacturers Association). All bearings are provided with extended lubrication lines terminating at the housing exterior.

The complete shaft and bearing assembly is mounted within the inner cylinder, safely isolating these components from the high velocity airstream.

Drive Isolated from Airstream

The shaft and bearing assembly is mounted within the inner cylinder to isolate these components from the high velocity airstream.

The V-belt drive assembly is extended through a two-piece belt fairing. The belt fairing is an aerodynamically designed tube, designed to maximize fan efficiency, minimize air blockage and reduce noise generation.

Motor

Motors for Arrangement 9, belt driven fans are standard foot-mounted NEMA design. All of the various enclosures (open drip-proof, totally enclosed, explosion proof, etc.) can be accommodated through the use of an adjustable motor base. This motor mounting platform pivots at several locations to offer a wide range of adjustment for belt tension.

Motors for Arrangement 4, direct drive fans are foot-mounted, NEMA standard, totally enclosed fan cooled (TEFC), continuous-duty, ball bearing type with Class "F" insulation and of cast iron construction when commercially available. Motors, which are equipped with grease lubricated bearings, have extended lube lines to the housing exterior. For ease of wiring the motor, wiring connections are extended to an external conduit box mounted on the fan exterior. The fan housing exterior has a duplicate motor nameplate mounted adjacent to the fan nameplate.

Spark Resistant Construction

Fan applications may involve the handling of fumes or vapors. Such applications require careful consideration by the system designer to ensure the safe handling of such gases. Aerovent offers the following classifications of spark resistant construction per AMCA Standard 99-0401. It is the specifier's or the user's responsibility to specify the type of spark resistant construction with full recognition of the potential hazards and the degree of protection required.

Type A - All parts of the fan in contact with the airstream must be made of nonferrous material — usually aluminum and limited to 200°F.

Type B - The fan shall have a nonferrous impeller and nonferrous rub ring about the opening through which the shaft passes — usually aluminum impeller and rub ring and limited to 200°F. Consult factory for availability.



Swingout Construction

Swingout Construction

Swingout construction provides easy access to the fan for cleaning and general maintenance without removing it from the ductwork. When quick-open clamp latches are released, the door swings out on heavy-duty hinges to provide out of the airstream access to the impeller for cleaning. For additional access to the shaft and bearings, a split inner cylinder is provided. Available in sizes 21-60. See dimensional data on page 12 for motor frame size limits.

Clamshell Construction

Clamshell construction is ideal for applications needing regular cleaning. Depending on the size, one door (sizes 18-36) or two doors (sizes 42-60) are secured with quick access latches. These doors open outward and allow access to the internal components of the fan. As standard, there is an access door on the inner cylinder, allowing easy access to clean around the bearings. It is essential to follow proper safety precautions during cleaning. If bearing, shaft or impeller replacement is required, the fan should be removed from the ductwork or roof to facilitate safe replacement of parts. If replacement of these parts while ducted or on the roof is required, it is recommended to use swingout construction.

High Moisture Modification

A shaft seal and added gaskets to the bearing housing protect the rotor assembly from damage due to moisture ingress. Ideal for steam and high humidity applications.



Clamshell Construction

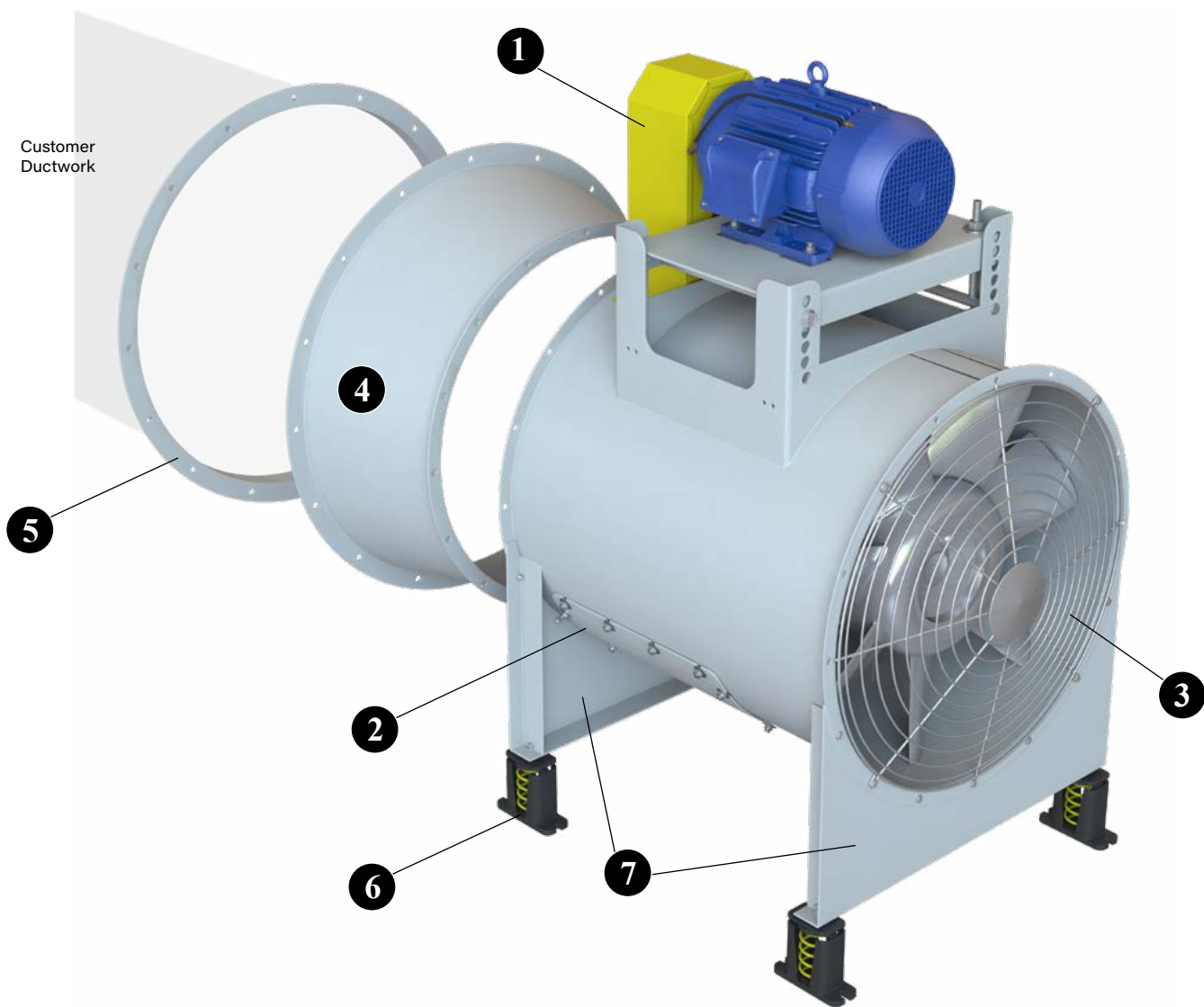

1 Belt Guard Belt guard protects personnel from the moving drive parts. OSHA and quick access guards are available.

2 Access Door For quick impeller inspection and maintenance. Access doors are specified where examination and cleaning of the fan interior is required.

3 Safety Screens Available for mounting in the fan inlet or outlet in non-ducted applications.

4 Inlet Cone Heavy-gauge and spun to match the impeller intake rim to ensure smooth airflow. Inlet cone flange is prepunched for mounting. Inlet cones are shipped loose as standard. An integral inlet cone is optional.

5 Companion Flange Companion flanges are commonly connected to a user's duct for easy installation of flexible connections between the fan and duct. Companion flanges and flex connectors are punched to match the fan's inlet or outlet punching.

6 Vibration Isolators Spring type vibration isolation mounts are available to dampen vibration and noise transmission in floor mounted installations. Also available in rubber-in-shear type construction.

7 Support Legs, Horizontal For horizontal flow with floor mounting, support legs are welded to the fan flange with bolt holes aligned for connection of ductwork.

Other Accessories Include:

- Inlet Bell
- Vibration Isolators (Ceiling Hung)
- Shaft Seal
- Support Legs (Brackets)
- Outlet Cone
- Suspension Clips Horizontal Ceiling Hung

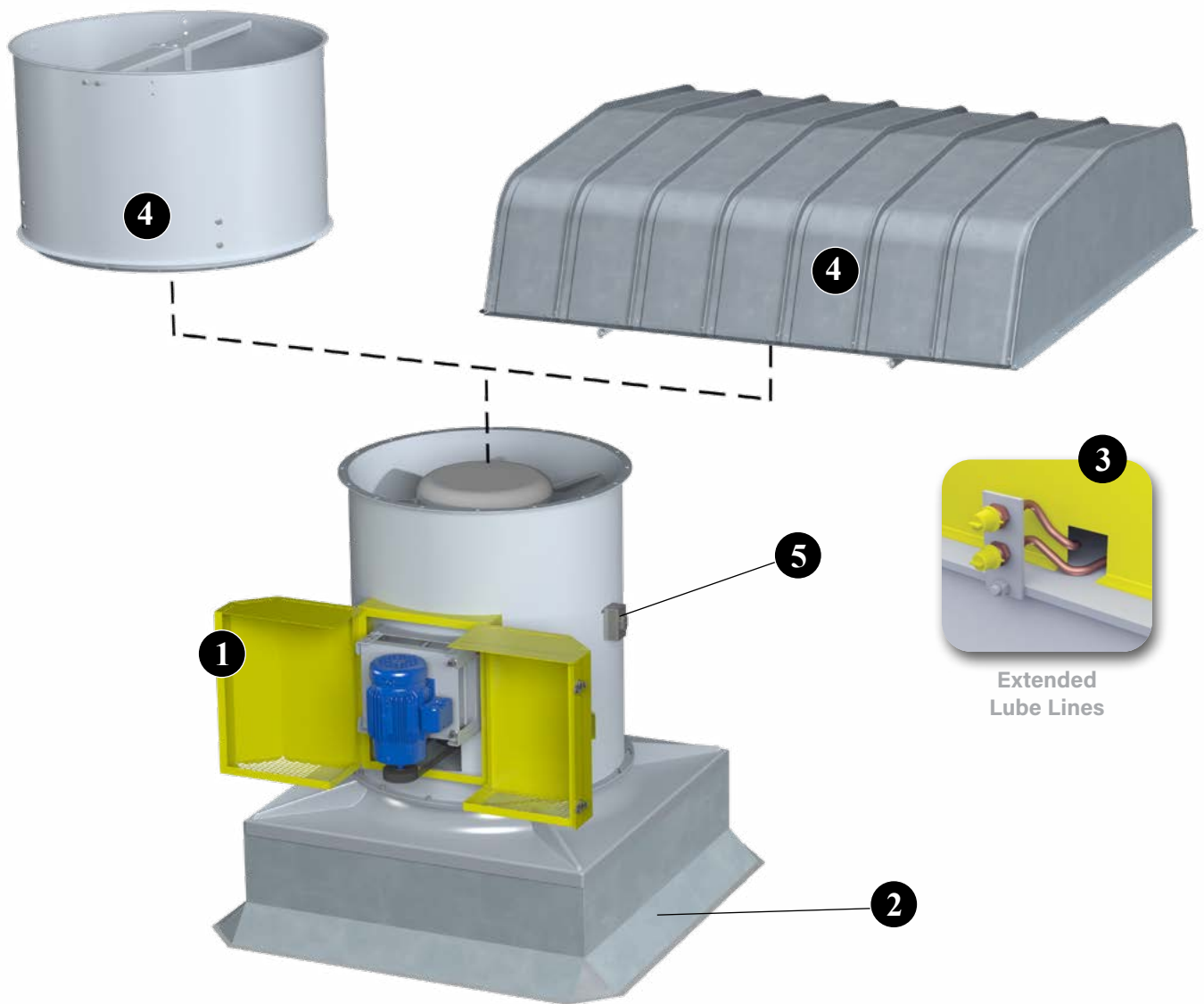

1 Weather Cover For outdoor installations, the weather cover completely encloses the motor and V-belt drive from the elements. Available in one-piece or clamshell construction. Provided with slots for ventilation, the cover is easily removable for inspection and maintenance. Weather covers are available for either horizontal or vertical flow fans.

2 Canted Roof Curb Prefabricated roof curbs are available in heavy-duty galvanized steel or aluminum construction, in heights of 8", 12" or 18". The canted curb is provided with a factory installed wood nailer. Curbs are provided with 1.5" of insulation as standard and feature continuously-welded seams for added rigidity and moisture protection. Prefabricated curbs are also available in raised cant, pitched and peak models. Minimum 12" high curbs are recommended for use with motorized dampers.

3 Extended Lube Lines Lube lines with grease fittings are extended to the outside of the fan housing on all models.

4 Stack Cap & Hood Stack caps are provided as a standard accessory on vertical roof mounted configurations. Stack caps feature butterfly type dampers that seal out weather when the fan is shut off. Filtered hood options available. Hoods are designed for either exhaust or supply airflow and can be fitted with Merv 8 throw away filters or aluminum washable filters to remove particulate from the supply airstream.

5 NEMA 3R Disconnect Switch Disconnect switches offer superior environmental protection. From waterproofing to hazardous environments, know that you and your equipment are safe. Positive electrical shutoff during fan cleaning or maintenance provides additional safety and peace of mind. For more information about disconnect switches, see page 9.

Mounting Configurations

Horizontal Construction

Horizontal Base Mounted (HBM) — Support legs are provided at each end of the fan for floor mounting.

Horizontal Ceiling Hung (HCH) — For duct mounted fans, four suspension clips are welded to the fan casing to allow ceiling suspension using rod hangers.

Horizontal (HOR) — For mounting configurations where support legs and suspension clips are not required.

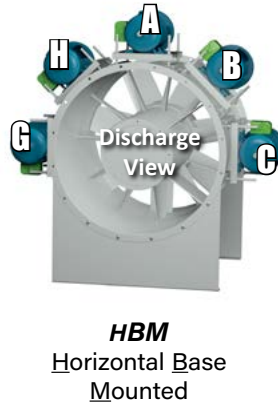
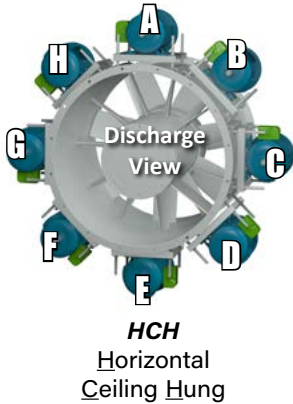

Vertical Construction

Floor or Ceiling Mounted (VUI/VUO/VDI/VDO) — Four vertical brackets are welded to either end of the fan housing. Bracket location is determined by airflow direction and support details (see below).

Roof Mounted (VRM) — A curb cap provides weathertight seal for roof curb mounted fans. A stack cap and weather cover are also available for the upblast style roof ventilator.

Vertical (VUN/VDN) — For mounting configurations where support brackets are not required.

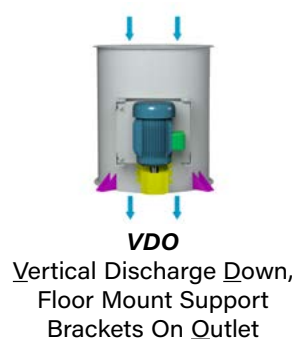
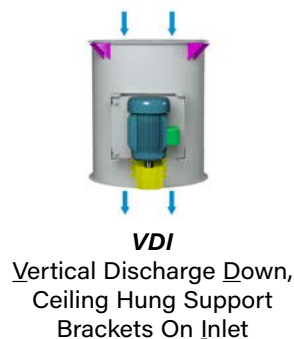
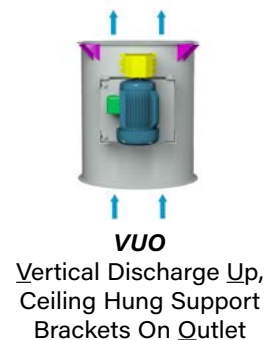
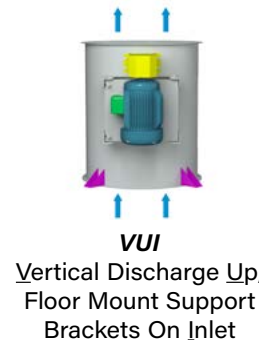
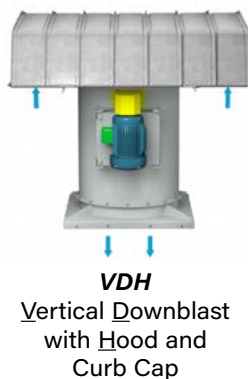
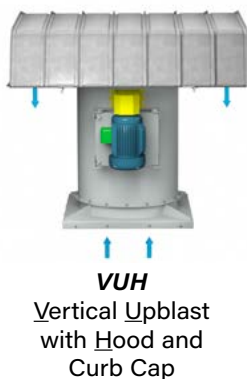

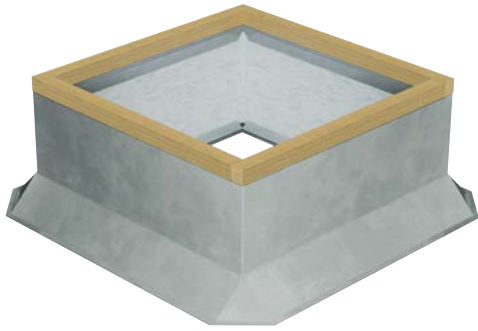

Canted Roof Curbs

- Constructed of galvanized steel with continuously-welded seams
- Large 3" built-in 45° cant to accommodate roofing material to top of curb. Cant is beveled at corners for better support of roofing material
- Wood nailer (1 1/2") secured to top ledge
- Lined with 1 1/2" fiberglass fire-resistant, sound-absorbing insulation
- Damper shelf standard
- Options: Aluminum construction, burglar security bars, metal liner (galvanized or aluminum), special heights up to 24"



Self-Flashing & Straight-Sided Roof Curbs

- Constructed of galvanized steel with continuously-welded seams
- Wide base plate (flashing) to ensure watertight seal to roof
- Top ledge covered with 3/16" polystyrene gasket (self-flashing) for weather seal and to reduce metal-to-metal conducted noise
- Wood nailer secured to top ledge (straight-sided)
- Lined with 1 1/2" fiberglass fire-resistant, sound-absorbing insulation
- Damper shelf standard
- Straight-sided roof curbs are constructed with the same features as the self-flashing curbs, but are one dimensional to allow for field supplied cants and roofing material to be brought up to the top of the curb
- Options: Aluminum construction, burglar security bars, metal liner (galvanized or aluminum), special heights up to 24", single- or double-pitched curbs for sloping roofs



Self-Flashing Vented Roof Curbs

For High Temperature Applications

- Completely assembled unit, easier to install and less expensive than a field constructed curb
- Constructed of galvanized steel with continuously-welded seams and wide base flashing for watertight seal to roof
- Meets NFPA-96 code requirements
- Top ledge covered with 3/16" polystyrene gasket
- Furnished with ventilation slots



Curb Adapters

- Constructed of galvanized steel with continuously-welded seams
- Top ledge covered with 3/16" polystyrene gasket to reduce metal-to-metal conducted noise and act as a weather seal
- Available in enlarger or reducer (shown) models

Disconnect switches provide positive electrical shutoff during fan cleaning or maintenance.

NEMA 3R Disconnect Switch

A NEMA 3R, rain proof, disconnect is available shipped loose for field mounting and wiring or factory mounted and wired externally.

NEMA 4 Disconnect Switch

A NEMA 4, water and dust tight, disconnect is available shipped loose for field mounting and wiring or factory mounted and wired externally.

NEMA 7/9 Disconnect Switch

A NEMA 7/9 disconnect switch is recommended on fans with explosion proof motors. The NEMA 7/9 switch is designed for use with fans operating in hazardous environments. Available shipped loose for field mounting and wiring. (Not shown.)



**NEMA 3R
Disconnect Switch**



**NEMA 4
Disconnect Switch**



Arrangements

Arrangement 9 Belt Driven

For applications that require the motor to be out-of-the-airstream or the versatility of a belt driven fan, the Arrangement 9 Model VPBD is the perfect choice. Driven through either a fixed or adjustable V-belt drive system, the exact point of rating can be achieved. Any future change in rating can be accomplished through a simple sheave change. Good for operation up to 200°F as standard, the Arrangement 9 can be customized to handle even the most severe of conditions.

Arrangement 4 Direct Drive

Where space constraints require the use of a complete "in line" fan or the desire is for a simple, dependable fan with minimum maintenance requirements, the direct drive Arrangement 4 is the logical choice. Constructed with the fan impeller mounted directly on the motor shaft, this fan provides premium efficiency with minimal obstructions in the airstream.

Bare Fan Weights (lb)

FAN SIZE	ARR. 9	FAN SIZE	ARR. 9	FAN SIZE	ARR. 4	FAN SIZE	ARR. 4
12B6	61	32B4	346	12D7	65	32D4	298
12B7	79	32B5	412	15D6	86	32D5	343
15B5	79	32B6	485	15D7	97	32D6	391
15B6	98	32B7	646	18D5	103	32D7	493
15B7	121	36B4	461	18D6	115	36D4	391
18B4	93	36B5	534	18D7	130	36D5	438
18B5	112	36B6	695	21D4	133	36D6	541
18B6	135	36B7	875	21D5	137	36D7	670
18B7	158	42B4	728	21D6	149	42D4	619
21B4	128	42B5	889	21D7	176	42D5	722
21B5	150	42B6	1068	24D4	173	42D6	851
21B6	173	48B4	1007	24D5	193	48D4	841
21B7	224	48B5	1186	24D6	215	48D5	970
24B4	195	54B3	1092	24D7	261	54D3	930
24B5	218	54B4	1272	28D4	227	54D4	1056
24B6	269	60B3	1357	28D5	260	60D3	1132
24B7	335			28D6	300		
28B4	254			28D7	347		
28B5	305						
28B6	370						
28B7	444						

Housing Gauges

FAN SIZE	HOUSING GAUGE
12	14
15	12
18	12
21	12
24	10
28	10
32	10
36	10
42	7
48	7
54	7
60	7

Accessory Weights (lb)

FAN SIZE	BELT GUARD	WEATHER COVER	INLET/OUTLET SCREEN	INLET BELL	INLET/OUTLET CONE	COMPANION FLANGE	SUPPORT LEGS		DIS-CHARGE CAP	CURB CAP
							HORIZ. FLOW	VERT. FLOW		
12	4	7	3	8	9	5	10	10	30	15
15	6	11	3	10	11	8	12	10	40	16
18	8	18	4	12	16	10	12	10	55	17
21	10	21	5	13	21	11	20	10	65	23
24	11	23	7	20	30	13	24	17	78	26
28	12	26	8	22	40	15	32	17	98	34
32	14	32	10	25	54	17	47	17	120	45
36	16	34	11	52	82	19	58	17	165	51
42	18	40	13	62	100	25	83	19	230	64
48	21	45	18	70	114	33	97	19	288	72
54	25	56	24	76	128	37	126	26	384	82
60	30	68	33	86	139	41	265	26	400	133

Motor Weights (lb)

FRAME	48	56	143T	145T	182T	184T	213T	215T	254T
ODP	7	11	33	44	71	82	124	144	185
TE	9	14	40	53	85	98	149	173	222

FRAME	256T	284T	286T	324T	326T	364T	365T	404T	405T
ODP	214	266	310	404	452	620	680	869	938
TE	257	319	372	485	542	744	816	1043	1126

Stack Cap Limits

FAN SIZE	MINIMUM CFM TO OPEN		MAXIMUM CFM*
	STAINLESS	ALUMINUM	
12	1372	1049	2502
15	2132	1630	3887
18	3058	2339	5577
21	4163	3184	7592
24	5426	4150	9895
28	7400	5659	13494
32	9644	7375	17586
36	12184	9317	22218
42	16650	12732	30361
48	21709	16601	39587
54	27404	20956	49972
60	33779	25831	61597

NOTE: The terminal velocity of rain is approximately 2,000 feet per minute. Selections below this point are not recommended if rain entry into the building is a concern.

* Ask about our extra heavy-duty stack cap if your CFM exceeds the maximum CFM.

Dimensional Data

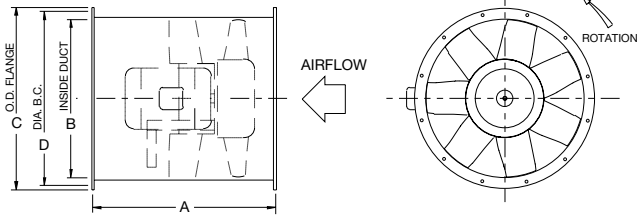

ARR. 4 - HORIZONTAL

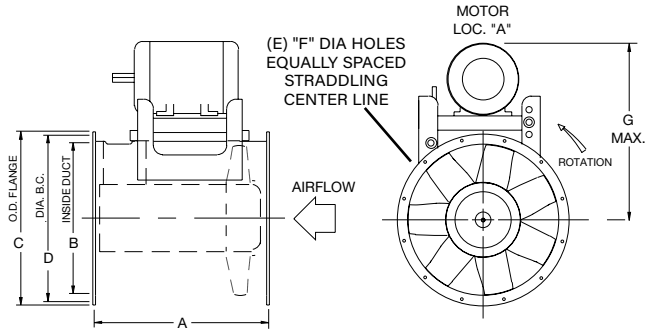

ARR. 9 - HORIZONTAL

HORIZONTAL DISCHARGES

HOR = Horizontal – No Clips or Legs **HCH** = Horizontal Ceiling Hung with Suspension Clips **HBM** = Horizontal Base Mounted with Support Legs

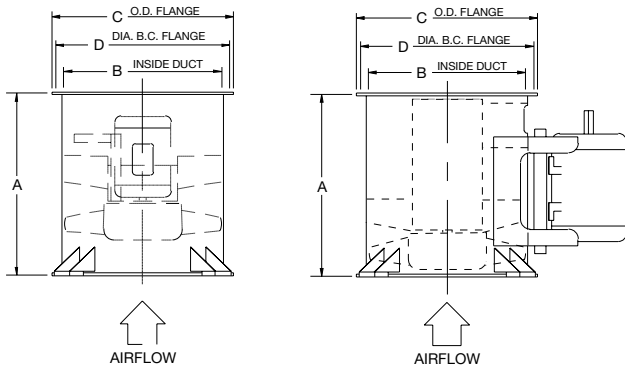

ARR. 4 - VERTICAL

ARR. 9 - VERTICAL

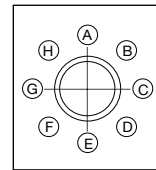
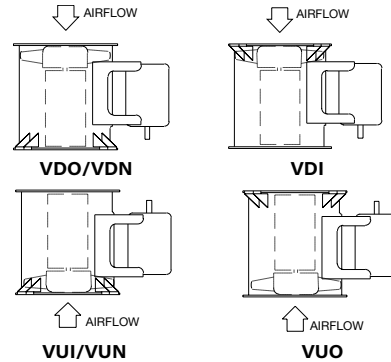

HORIZONTAL MOTOR LOCATIONS (VIEWED FROM FAN OUTLET)

VERTICAL DISCHARGES

VDO = Vertical Down Floor Mounted With Legs
VDN = Vertical Down Discharge Without Legs
VDI = Vertical Down Ceiling Hung With Legs

VUI = Vertical Up Floor Mounted With Legs
VUN = Vertical Up Discharge Without Legs
VUO = Vertical Up Ceiling Hung With Legs

FAN SIZE	A				B	C	D	E	F	G (MAX.)	MAXIMUM MOTOR FRAME										SWING-OUT
	ARR. 9 - HUB RATIO		ARR. 4 - HUB RATIO								ARR. 9 - HUB RATIO					ARR. 4 - HUB RATIO					
	3-5	6-7	3-5	6-7							3	4	5	6	7	3	4	5	6	7	
12	NA	24.50	NA	24.50	12.16	15.16	13.88	8	0.44	19.25	NA	NA	NA	184T	184T	NA	NA	NA	NA	145T	-
15	22.00	27.00	NA	27.00	15.16	18.16	16.88	8	0.44	20.50	NA	NA	215T	215T	215T	NA	NA	NA	145T	184T	-
18	24.50	28.00	24.50	28.00	18.16	21.16	19.88	8	0.44	27.50	NA	215T	215T	215T	215T	NA	NA	145T	184T	215T	-
21	27.00	32.00	27.00	32.00	21.19	24.19	22.88	8	0.44	31.75	NA	256T	256T	256T	256T	NA	145T	184T	215T	215T	256T
24	28.00	36.25	28.00	36.25	24.19	27.19	25.88	12	0.44	34.50	NA	256T	256T	256T	256T	NA	184T	215T	215T	256T	256T
28	32.00	40.25	32.00	40.25	28.25	31.25	30.00	12	0.44	38.25	NA	286T	286T	286T	286T	NA	215T	215T	256T	286T	286T
32	36.25	47.00	36.25	47.00	32.25	35.25	34.00	12	0.44	41.00	NA	286T	286T	286T	286T	NA	215T	256T	286T	365T	286T
36	40.25	53.25	40.25	53.25	36.25	39.25	38.00	16	0.44	45.25	NA	326T	326T	326T	326T	NA	256T	286T	365T	405T	326T
42	47.00	53.25	47.00	53.25	42.38	46.38	44.63	16	0.56	49.50	NA	326T	326T	326T	NA	286T	365T	405T	NA	NA	326T
48	53.25	NA	53.25	NA	48.38	52.38	50.63	16	0.56	53.25	NA	326T	326T	NA	NA	NA	365T	405T	NA	NA	365T
54	53.25	NA	53.25	NA	54.38	58.38	56.63	16	0.56	59.00	365T	365T	NA	NA	NA	365T	405T	NA	NA	NA	365T
60	53.25	NA	53.25	NA	60.38	64.38	63.38	20	0.56	60.25	365T	NA	NA	NA	NA	405T	NA	NA	NA	NA	365T

1001590B 1001592B
 1001591B 1001593B

DIMENSIONS ARE NOT TO BE USED FOR CONSTRUCTION. CERTIFIED DRAWINGS AVAILABLE UPON REQUEST.



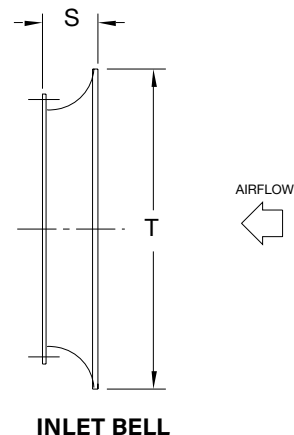
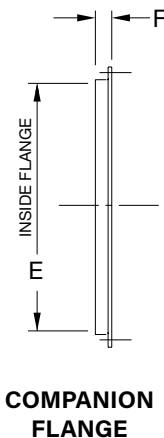
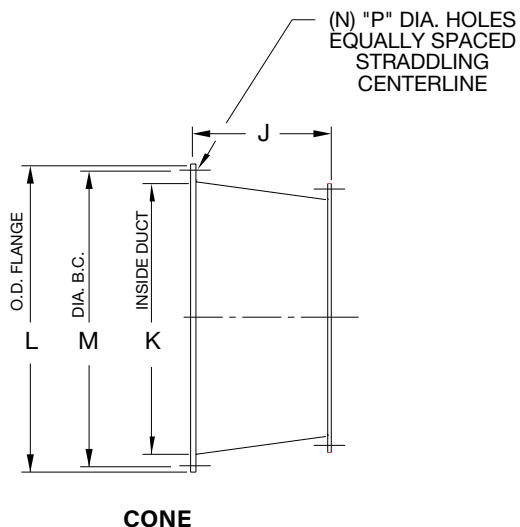

FAN SIZE	CONE						COMPANION FLANGE		INLET BELL		FAN AREA (FT ²)	CONE AREA (FT ²)
	J	K	L	M	N	P	E	F	S	T		
12	8.50	15.16	18.44	16.88	8	0.56	12.16	1.50	2.52	15.19	0.81	1.25
15	8.50	18.16	21.44	19.88	8	0.56	15.16	1.50	3.12	19.77	1.25	1.80
18	8.50	21.19	24.50	22.88	8	0.56	18.16	1.50	3.71	23.72	1.80	2.45
21	8.50	24.19	27.50	25.88	12	0.56	21.19	1.50	4.31	27.67	2.45	3.19
24	11.50	28.25	31.56	30.00	12	0.56	24.19	1.50	4.96	31.63	3.19	4.35
28	11.50	32.25	35.56	34.00	12	0.56	28.25	1.50	5.75	36.90	4.35	5.67
32	11.50	36.25	39.56	38.00	16	0.56	32.25	1.50	6.54	42.17	5.67	7.17
36	17.00	42.38	46.81	44.63	16	0.69	36.25	1.50	7.39	47.44	7.17	9.80
42	17.00	48.38	52.81	50.63	16	0.69	42.38	2.00	8.59	55.34	9.80	12.77
48	17.00	54.38	58.69	56.63	16	0.69	48.38	2.00	9.76	63.25	12.77	16.13
54	17.00	60.38	64.94	63.38	20	0.69	54.38	2.00	10.98	71.16	16.13	19.88
60	17.00	66.44	70.94	69.38	24	0.69	60.38	3.00	12.20	79.06	19.88	24.08

AC13716M

DIMENSIONS ARE NOT TO BE USED FOR CONSTRUCTION. CERTIFIED DRAWINGS AVAILABLE UPON REQUEST.





Models VP | VPBD

Fans shall be Model VP/VPBD Vaneaxial Fans as manufactured by Aerovent, Minneapolis, Minnesota. Fans shall be Arrangement 9, V-belt driven with the impeller mounted on a separate shaft and bearings supported completely within an enclosed tube isolated from the high velocity airstream or Arrangement 4, with the impeller mounted directly on the motor shaft and with the impeller and motor assembly enclosed entirely within the fan casing.

PERFORMANCE — Performance ratings shall conform to AMCA Standard 211 (air performance). Fans shall be tested in accordance with ANSI/AMCA Standard 210 (air performance) and 300 (sound performance) in an AMCA accredited laboratory. Fans shall be licensed to bear the AMCA certified ratings seal for air and fan energy index (FEI).

Model VP/VPBD shall be available UL 705 listed. Fans shall bear a permanently attached nameplate displaying model and serial number of the unit for future identification.

HOUSING — Fan housings shall be welded of hot rolled steel. Inlet and outlet flanges are standard.

GUIDE VANES — Fan housings shall be fitted with aerodynamically designed stationary straightening guide vanes on the air discharge side of the impeller. The guide vanes shall be welded to both the inner cylinder and the fan housing interior and function to aid in the elimination of swirl and turbulence downstream thereby recovering rotational energy losses, improving efficiency and static pressure capability, and reducing fan noise generation.

IMPELLER — The fan impeller shall be a solid one-piece casting of aluminum and shall contain seven blades and an integral center hub. The impeller shall have blades of airfoil shape designed with a variable hub ratio system to allow the selected fan to operate at the highest efficiency possible. Impellers shall be machined to the proper diameter so that blade tip clearance shall be within tolerance necessary to ensure certified fan performance. The impeller shall be secured to the fan/motor shaft with a taper lock bushing.

SHAFT (ARR. 9) — Shafts shall be AISI 1040 or 1045 hot rolled steel, accurately turned, ground, polished and ring gauged for accuracy. Shafts shall be sized for the first critical speed of at least 1.43 times the maximum speed.

BEARINGS (ARR. 9) — Bearings shall be heavy-duty, grease lubricated, anti-friction ball or roller, self-aligning, pillow block type and selected for a minimum average bearing life (AFBMA L-50) in excess of 200,000 hours at the maximum fan RPM. All bearings are provided with pre-filled factory extended lubrication lines terminating at the housing exterior.

DRIVE (ARR. 9) — The fan shall be equipped with a (fixed/adjustable) pitch V-belt drive selected to operate the fan at the correct operational RPM. The V-belt drive shall consist of cast iron sheaves and anti-static conducting belts and shall be selected with a (1.2/1.5) safety factor based upon the required brake horsepower of the fan.

The complete fan shaft and bearing assembly is mounted within a steel fabricated inner cylinder. The V-belt drive assembly is extended through a two-piece belt fairing. The belt fairing shall be an aerodynamically shaped tube designed to maximize fan efficiency. The belt fairing is welded continuously to both the inner cylinder that houses the fan shaft and bearings and the fan housing.

MOTOR — Motors for Arrangement 9 fans shall be manufactured in accordance with current applicable standards of IEEE and NEMA and, where applicable, shall meet current EPACT standards. Motors shall be foot-mounted, NEMA standard (ODP, TEFC, Explosion-Proof), continuous-duty, ball bearing type with class (B, F) insulation and of cast iron construction when commercially available.

Motors for Arrangement 4 fans shall be foot-mounted, NEMA standard, totally enclosed fan cooled (TEFC), continuous-duty, ball bearing type with class "F" insulation and of cast iron construction when commercially available. For ease in wiring the motor, wiring connections shall be extended to an exterior conduit box located on the exterior of the fan housing. A duplicate motor nameplate shall be mounted on the exterior of the fan adjacent to the fan nameplate. External grease fittings with pre-filled factory extended grease leads shall be supplied for lubrication of the motor bearings on all motors that provide grease fittings.

FINISH — The entire fan assembly, excluding the impeller and shaft, shall be properly washed and pretreated before application of a rust-preventative primer, if called out on the order. After the fan is completely assembled, a finish coat of paint shall be applied to the entire assembly, if called out on the order. The fan shaft shall be coated with a petroleum-based rust protectant.

FACTORY RUN TEST — All fans with motors and drives mounted by Aerovent shall be completely assembled and test run as a unit at the specified operating speed prior to shipment. Each impeller shall be statically and dynamically balanced in accordance with ANSI/AMCA 204-96 "Balance Quality and Vibration Levels for Fans" to Fan Application Category BV-3, Balance Quality Grade G6.3. Balance readings shall be taken by electronic type equipment in the axial, vertical and horizontal directions on each of the bearings. Records shall be maintained and a written copy shall be available upon request.



WALL MOUNTED FANS | TUBEAXIAL & VANEAXIAL FANS | CENTRIFUGAL FANS & BLOWERS
ROOF VENTILATORS | AIR HEATERS & COOLERS | AIR MAKE-UP | FIBERGLASS FANS | CUSTOM FANS

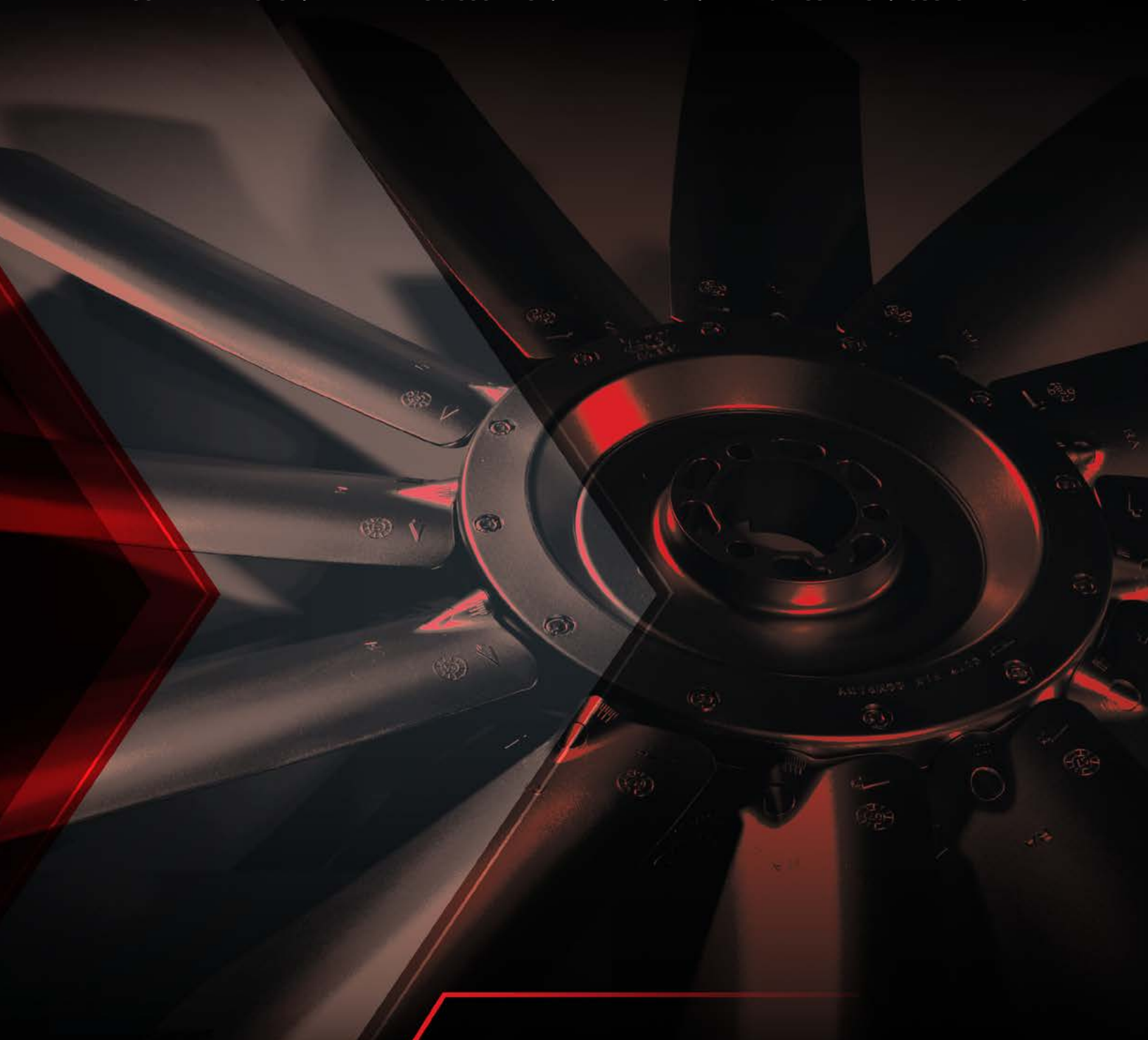

AEROVENT 
INDUSTRIAL VENTILATION SYSTEMS

AEROVENT.COM

5959 Trenton Lane N. | Minneapolis, MN 55442 | Phone: 763-551-7500 | Fax: 763-551-7501

©2024 Aerovent, Minneapolis, MN. All rights reserved. Catalog illustrations cover the general appearance of Aerovent products at the time of publication and we reserve the right to make changes in design and construction at any time without notice.