

## Application

Model OFSD-311 is an 'out of wall' high performance combination fire smoke damper with Class I leakage. The OFSD-311 is approved for use in walls, partitions, and floors with fire resistance ratings less than 3 hours. Removal of wall grille allows access to the actuator and other components. High strength airfoil blades insure the lowest resistance to airflow in HVAC systems with velocities up to 4,000 fpm (20.3 m/s) and pressures up to 8 in. wg (2 kPa). Model OFSD-311 shall be installed vertically (with blades running horizontal) or horizontally and rated for airflow and leakage in either direction.

## UL555 Fire Resistance Ratings

### Fire Rating

1½ hours in walls

### Dynamic Closure

Actual ratings are size dependent

### Maximum Velocity

Up to 4,000 fpm (20.3 m/s)

### Maximum Pressure

Up to 8 in. wg (2 kPa) - differential pressure

## UL555S Leakage Ratings

### Leakage Class

I

### Operational Rating

Actual ratings are size dependent

### Maximum Velocity

Up to 4,000 fpm (20.3 m/s)

### Maximum Temperature

350°F (177°C) - actuator dependent



Grille is not provided.

W & H dimensions furnished approximately ¼ in. (6mm) undersize. Add blanket thickness (½ in. 3mm) and sleeve thickness for overall sleeved damper dimension.

Oversize wall opening as follows: Nominal damper size plus ¾ in. (9.5mm).



See complete marking on product.

UL 555 and UL 555S  
 Classification R13317

## Size Limitations

| WxH    | Minimum Size | Maximum Size   |                  |
|--------|--------------|----------------|------------------|
|        |              | Single Section | Multiple Section |
| Inches | 8 x 8        | 32 x 30        | 36 x 36          |
| mm     | 203 x 203    | 813 x 762      | 914 x 914        |

Model OFSD-311 meets the requirements for fire dampers, smoke dampers and combination fire smoke dampers established by:

**National Fire Protection Association**  
 NFPA Standards 80, 90A, 92, 101 & 105

**IBC International Building Codes**

**CSFM California State Fire Marshal**  
 Fire Damper Listing (#3225-0981:103)  
 Leakage (Smoke) Damper Listing (#3230-0981:104)

## Construction

|                            | Standard  | Optional   |
|----------------------------|---|--|
| <b>Frame Material</b>      | Galvanized Steel                                  | -  |
| <b>Frame Thickness</b>     | 16 ga. (1.5mm)                                    | -  |
| <b>Frame Type</b>          | 5 in. x 1in. (127mm x 25mm) hat channel           | -  |
| <b>Blade Action</b>        | Opposed   | -  |
| <b>Blade Material</b>      | Galvanized Steel                                  | -  |
| <b>Blade Thickness</b>     | 14 ga. (2mm) equivalent                           | -  |
| <b>Blade Type</b>          | Airfoil   | -  |
| <b>Blade Orientation</b>   | Horizontal  | -  |
| <b>Linkage</b>             | Plated steel out of air-stream, concealed in jamb | 316SS  |
| <b>Axle Bearings</b>       | 316SS   | -  |
| <b>Axle Material</b>       | Plated Steel                                      | 316SS  |
| <b>Blade Seals</b>         | Silicone  | -  |
| <b>Jamb Seals</b>          | Stainless Steel                                   | -  |
| <b>Closure Device</b>      | RRL   | RRL/OCI,<br>TOR,<br>Fusible Link                                     |
| <b>Closure Temperature</b> | 165°F (74°C)                                      | 212°F (100°C),<br>250°F (121°C),<br>286°F (141°C)*,<br>350°F (177°C) |
| <b>Mounting</b>            | Vertical  | Horizontal   |

\*only available with fusible link

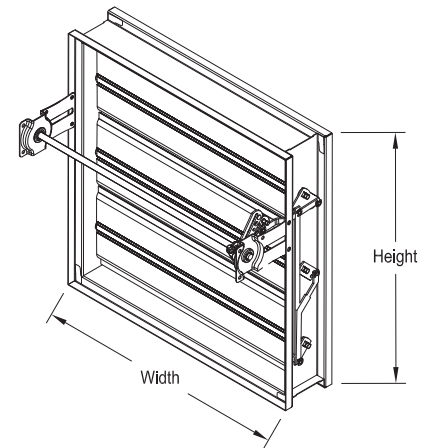

### Note:

The frames are constructed with reinforced corners. Low profile head and sill are used on sizes less than 17 in. (432 mm) high for lower pressure drop and improved damper performance.

## Options

- [BACnet test module - 120V](#)
- [BACnet test module - 24V](#)
- Clean wrap
- [Greenheck test switches \(GTS\)](#)
- Grille tabs
- [Momentary test switch](#)
- [Retaining angles](#)
- Sealed transitions and sleeves
- [Smoke detector - no flow](#)
- [Smoke detector - low flow](#)
- Transitions: R, C, O

# Pressure Drop

## AMCA Figure 5.2

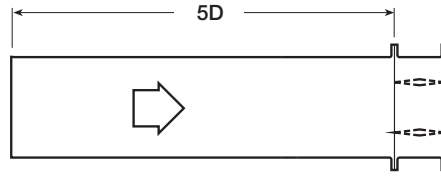

12 in. x 12 in. (305mm x 305mm)

| Velocity (fpm) | Pressure Drop (in. wg) |
|----------------|------------------------|
| 500            | 0.03                   |
| 1000           | 0.11                   |
| 1500           | 0.24                   |
| 2000           | 0.42                   |
| 2500           | 0.66                   |
| 3000           | 0.95                   |
| 3500           | 1.30                   |
| 4000           | 1.70                   |

24 in. x 24 in. (610mm x 610mm)

| Velocity (fpm) | Pressure Drop (in. wg) |
|----------------|------------------------|
| 500            | 0.01                   |
| 1000           | 0.06                   |
| 1500           | 0.12                   |
| 2000           | 0.22                   |
| 2500           | 0.34                   |
| 3000           | 0.49                   |
| 3500           | 0.67                   |
| 4000           | 0.87                   |

36in. x 36 in. (914mm x 914mm)

| Velocity (fpm) | Pressure Drop (in. wg) |
|----------------|------------------------|
| 500            | 0.01                   |
| 1000           | 0.05                   |
| 1500           | 0.12                   |
| 2000           | 0.21                   |
| 2500           | 0.32                   |
| 3000           | 0.47                   |
| 3500           | 0.63                   |
| 4000           | 0.83                   |

12in. X 48 in. (305mm x 1219mm)

| Velocity (fpm) | Pressure Drop (in. wg) |
|----------------|------------------------|
| 500            | 0.01                   |
| 1000           | 0.05                   |
| 1500           | 0.12                   |
| 2000           | 0.21                   |
| 2500           | 0.33                   |
| 3000           | 0.48                   |
| 3500           | 0.65                   |
| 4000           | 0.85                   |

48 in. x 12 in. (1219mm x 305mm)

| Velocity (fpm) | Pressure Drop (in. wg) |
|----------------|------------------------|
| 500            | 0.02                   |
| 1000           | 0.08                   |
| 1500           | 0.18                   |
| 2000           | 0.33                   |
| 2500           | 0.51                   |
| 3000           | 0.74                   |
| 3500           | 1.00                   |
| 4000           | 1.31                   |

## AMCA Figure 5.3

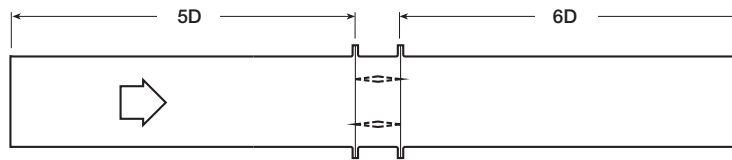

12 in. x 12 in. (305mm x 305mm)

| Velocity (fpm) | Pressure Drop (in. wg) |
|----------------|------------------------|
| 500            | 0.01                   |
| 1000           | 0.06                   |
| 1500           | 0.13                   |
| 2000           | 0.23                   |
| 2500           | 0.37                   |
| 3000           | 0.53                   |
| 3500           | 0.73                   |
| 4000           | 0.95                   |

24 in. x 24 in. (610mm x 610mm)

| Velocity (fpm) | Pressure Drop (in. wg) |
|----------------|------------------------|
| 500            | 0.01                   |
| 1000           | 0.02                   |
| 1500           | 0.06                   |
| 2000           | 0.10                   |
| 2500           | 0.16                   |
| 3000           | 0.23                   |
| 3500           | 0.32                   |
| 4000           | 0.42                   |

36in. x 36 in. (914mm x 914mm)

| Velocity (fpm) | Pressure Drop (in. wg) |
|----------------|------------------------|
| 500            | 0.01                   |
| 1000           | 0.02                   |
| 1500           | 0.05                   |
| 2000           | 0.09                   |
| 2500           | 0.14                   |
| 3000           | 0.21                   |
| 3500           | 0.29                   |
| 4000           | 0.38                   |

12in. X 48 in. (305mm x 1219mm)

| Velocity (fpm) | Pressure Drop (in. wg) |
|----------------|------------------------|
| 500            | 0.01                   |
| 1000           | 0.03                   |
| 1500           | 0.06                   |
| 2000           | 0.11                   |
| 2500           | 0.18                   |
| 3000           | 0.25                   |
| 3500           | 0.34                   |
| 4000           | 0.45                   |

48 in. x 12 in. (1219mm x 305mm)

| Velocity (fpm) | Pressure Drop (in. wg) |
|----------------|------------------------|
| 500            | 0.01                   |
| 1000           | 0.04                   |
| 1500           | 0.10                   |
| 2000           | 0.18                   |
| 2500           | 0.29                   |
| 3000           | 0.42                   |
| 3500           | 0.57                   |
| 4000           | 0.74                   |

## AMCA Figure 5.5

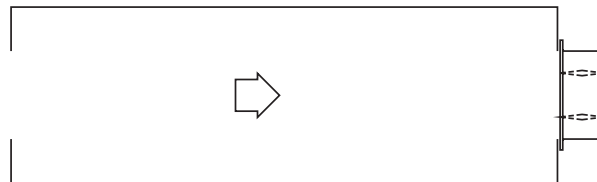

12 in. x 12 in. (305mm x 305mm)

| Velocity (fpm) | Pressure Drop (in. wg) |
|----------------|------------------------|
| 500            | 0.04                   |
| 1000           | 0.18                   |
| 1500           | 0.42                   |
| 2000           | 0.75                   |
| 2500           | 1.17                   |
| 3000           | 1.68                   |
| 3500           | 2.29                   |
| 4000           | 2.09                   |

24 in. x 24 in. (610mm x 610mm)

| Velocity (fpm) | Pressure Drop (in. wg) |
|----------------|------------------------|
| 500            | 0.03                   |
| 1000           | 0.13                   |
| 1500           | 0.29                   |
| 2000           | 0.52                   |
| 2500           | 0.81                   |
| 3000           | 1.17                   |
| 3500           | 1.60                   |
| 4000           | 2.14                   |

36in. x 36 in. (914mm x 914mm)

| Velocity (fpm) | Pressure Drop (in. wg) |
|----------------|------------------------|
| 500            | 0.03                   |
| 1000           | 0.12                   |
| 1500           | 0.27                   |
| 2000           | 0.48                   |
| 2500           | 0.75                   |
| 3000           | 1.08                   |
| 3500           | 1.48                   |
| 4000           | 1.93                   |

12in. X 48 in. (305mm x 1219mm)

| Velocity (fpm) | Pressure Drop (in. wg) |
|----------------|------------------------|
| 500            | 0.03                   |
| 1000           | 0.12                   |
| 1500           | 0.27                   |
| 2000           | 0.49                   |
| 2500           | 0.77                   |
| 3000           | 1.11                   |
| 3500           | 1.51                   |
| 4000           | 1.97                   |

48 in. x 12 in. (1219mm x 305mm)

| Velocity (fpm) | Pressure Drop (in. wg) |
|----------------|------------------------|
| 500            | 0.03                   |
| 1000           | 0.14                   |
| 1500           | 0.32                   |
| 2000           | 0.57                   |
| 2500           | 0.89                   |
| 3000           | 1.28                   |
| 3500           | 1.75                   |
| 4000           | 2.29                   |



Greenheck Fan Corporation certifies that the model OFSD-311 shown herein is licensed to bear the AMCA Seal. The ratings shown are based on tests and procedures performed in accordance with AMCA Publication 511 and comply with the requirements of the AMCA Certified Ratings Seal applies to air performance ratings only.

## Application Data

### Actuator Space Envelopes

The drawing below and corresponding table show the minimum dimensions required for internal actuator mounting on OFSD-311. The standard mounting locations provide enough space for the mounting of actuators and controls plus allowing space for a grille.

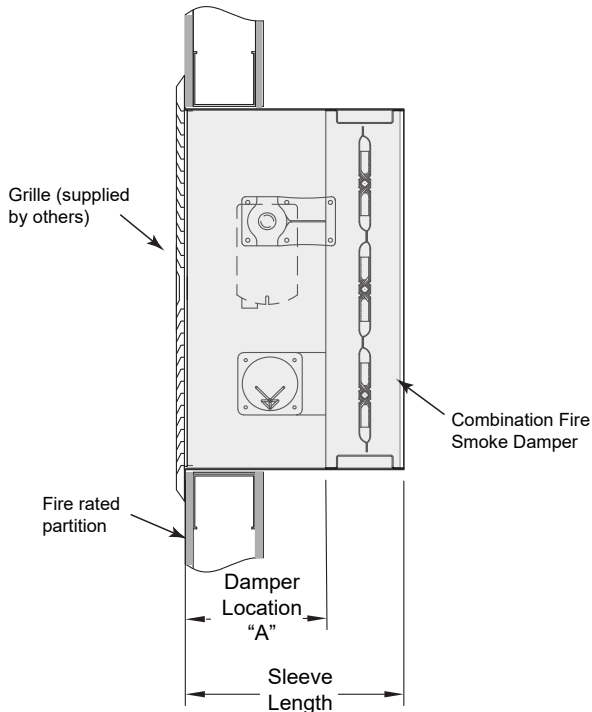

OFSD's that don't require a breakaway connection

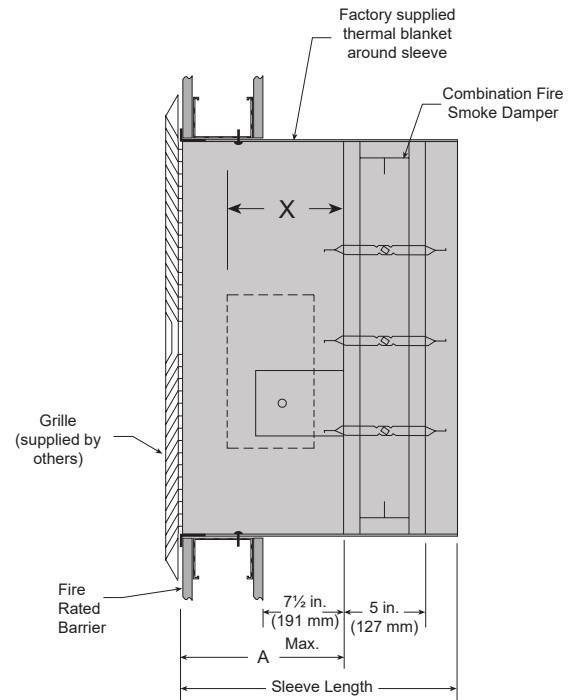

OFSD's that require a breakaway connection

| Actuator Type/Model            | 'X' Dimension     |
|--------------------------------|-------------------|
| FSLF24-S, 120, 230-S<br>Belimo | 7 1/2 in (191mm)  |
| FSNF24, 120, 230-S Belimo      | 7 3/8 in. (187mm) |
| FSTF24, 120, 230-S Belimo      | 7 1/8 in (181mm)  |
| MSXX09 Series Honeywell        | 7 1/2 in (191mm)  |
| MSXX04 Series Honeywell        | 7 1/2 in (191mm)  |
| MSXX20 Series Honeywell        | 7 1/2 in (191mm)  |

### Sleeve Information

Sleeve length is dependent on actuator, grille depth, OBD depth, and damper height and whether or not a breakaway connection is required on the side opposite the actuator.

'Sleeve Gauge' = 16 ga. or 20 ga. (1.5mm or 1mm)

### Wall Opening Sizing

To accommodate for sleeve and thermal blanket thickness, the wall opening must be oversized by 3/8 in. (9.5mm) as shown.

For example:

If the nominal damper size required is 18 in. x 14 in. (457mm x 356mm), the wall opening size needs to be 18 3/8 in. x 14 3/8 in. (467mm x 365mm).

The damper itself is undersized a 1/4 in. (6mm) on each dimension for an actual size of 17 3/4 in. x 13 3/4 in. (451mm x 349mm). This is also the inside dimension of the sleeve (for grille considerations).

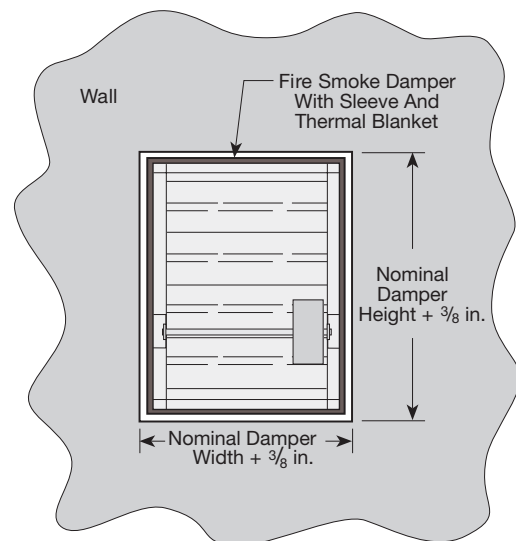



[INSTALLATION](#)



[CATALOG](#)



[DAMPER  
SELECTION GUIDE](#)



[SPECIFICATIONS](#)



[WARRANTY](#)