

STANDARD CONSTRUCTION

FRAME: .125" thick (nominal) extruded aluminum, 6063-T52/T6 alloy. Welded construction.

BLADE: .081" thick (nominal) extruded aluminum, 6063-T52/T6 alloy, mechanical fastening construction. Blades approximately 4" on centers.

LOUVER FACE: Full width sill with head and blades contained within jambs.

SCREEN: (When indicated, in a removable frame.)
 ½" flattened aluminum (.051" thick),

-or- ½" sq. mesh, intermediate double-crimped aluminum wire, .063" dia.,

-or- 1⅞ mesh, .011" dia. aluminum wire, insect screen.

FINISH: Mill

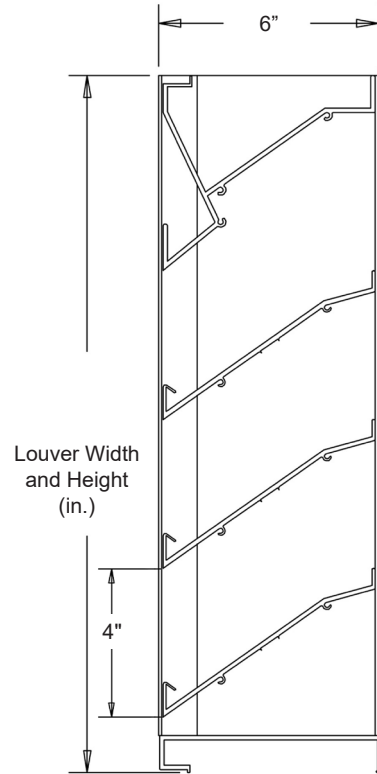

OPTIONS

Finish - Baked Enamel, Kynar, Anodize
 Extended Sill Flashing - available with Mill, Painted, or Anodized finishes.

NOTES

1. ½" nominal deduction will be made to the opening size given.
2. Panels over 48" wide will have a 2" x 2" x ¼" vertical interior blade support angle at approximate center of panels.
3. Approximate shipping weight is 6.0 lbs./sq.ft.

LOUVER SIZES

Min Panel	Max Single Panel
12"W x 12"H	96"W x 96"H

Windload requirements may limit panel sizes.

This louver has been tested to **AMCA Standard 540 for Wind Borne Debris Impact Resistance.** See Page 2 for seal and listing information.

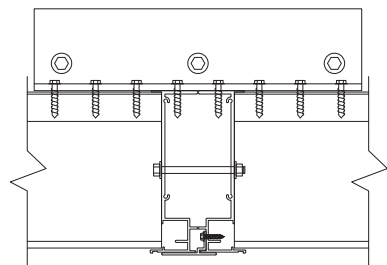

Standard Vertical Mullion

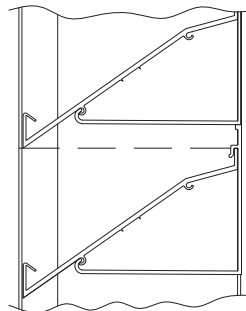

Standard Horizontal Mullion

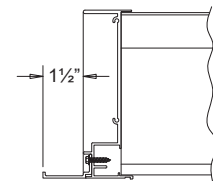

Optional Flange Frame (Jamb shown)

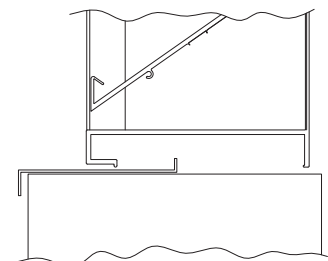

Optional Extended Sill

Item #	Qty	Width	Height	Width	Height	Mullion	Type	Location	Union Made
		Opening Size		Louver Size			Screens		
Arch. / Eng. :						EDR:	ECN:	Job:	
Contractor:									
Project:						Date:	DWN:	DWG:	

In the interest of product development, Louvers & Dampers reserves the right to make changes without notice.

PERFORMANCE DATA

Pressure Drop: .14 in. w.g. at 1000 fpm (intake)

Free Area: 9.24 sq.ft. (0.858 sq.m.) = 58% for 48"W x 48"H sample tested in accordance with AMCA Standard 500-L.

Beginning Point of Water Penetration: Above 1250 fpm (11,550 cfm)

Ratings do not include effects of a screen.

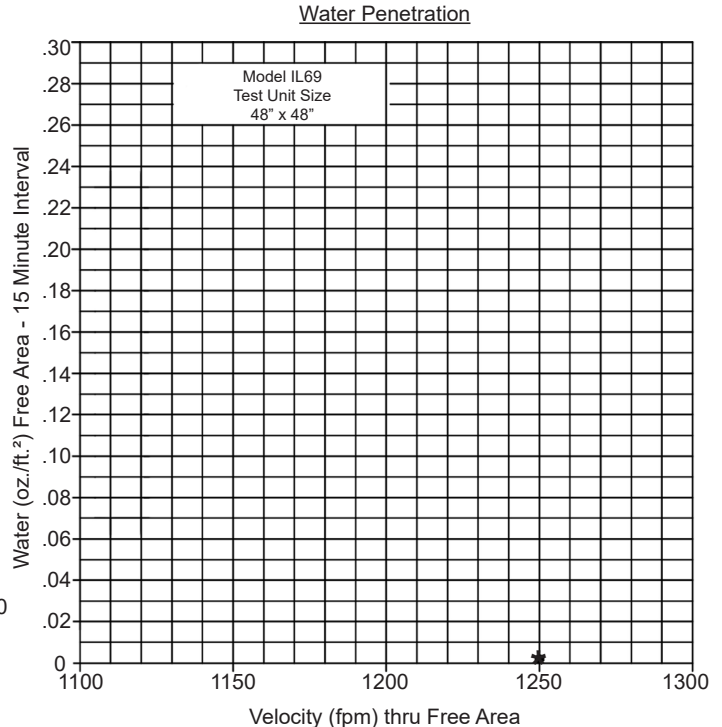
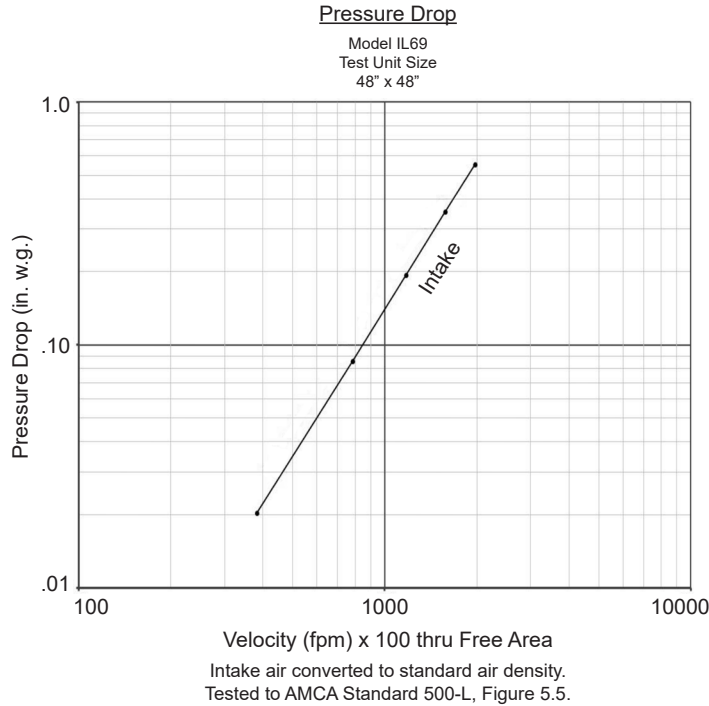

The Beginning Point of Water Penetration is above 1250 FPM through the Face Free Area of the louver.

* AMCA Standard 500 limits testing of Water Penetration to either a maximum velocity of 1250 FPM or 2.5 ounces of water per square foot of louver Free Area.

Free Area (sq. ft.)

		Width in. (mm)							
		12" (305)	24" (610)	36" (914)	48" (1219)	60" (1524)	72" (1829)	84" (2134)	96" (2438)
Height in. (mm)	12" (305)	0.18 (0.016)	0.43 (0.039)	0.69 (0.064)	0.94 (0.087)	1.16 (0.107)	1.42 (0.131)	1.67 (0.155)	1.93 (0.179)
	24" (610)	0.69 (0.064)	1.70 (0.157)	2.70 (0.250)	3.71 (0.344)	4.59 (0.426)	5.59 (0.519)	6.60 (0.613)	7.60 (0.706)
	36" (914)	1.21 (0.112)	2.96 (0.274)	4.72 (0.438)	6.47 (0.601)	8.01 (0.744)	9.76 (0.906)	11.52 (1.070)	13.27 (1.232)
	48" (1219)	1.72 (0.159)	4.23 (0.392)	6.73 (0.625)	9.24 (0.858)	11.43 (1.061)	13.93 (1.294)	16.44 (1.527)	18.94 (1.759)
	60" (1524)	2.24 (0.208)	5.49 (0.510)	8.75 (0.812)	12.00 (1.114)	14.85 (1.379)	18.11 (1.682)	21.36 (1.984)	24.62 (2.287)
	72" (1829)	2.75 (0.255)	6.76 (0.628)	10.72 (0.995)	14.77 (1.372)	18.27 (1.739)	22.28 (2.069)	26.28 (2.441)	30.29 (2.814)
	84" (2134)	3.72 (0.303)	8.02 (0.745)	12.78 (1.187)	17.53 (1.628)	21.69 (2.015)	26.45 (2.457)	31.20 (2.898)	35.96 (3.340)
	96" (2438)	3.78 (0.351)	9.29 (0.863)	14.79 (1.374)	20.30 (1.885)	25.12 (2.333)	30.62 (2.844)	36.13 (3.356)	41.63 (3.867)



Louvers & Dampers certifies that the Model IL69 shown herein is licensed to bear the AMCA seal. The ratings shown are based on tests and procedures performed in accordance with AMCA Publication 511 and comply with the requirements of the AMCA Certified Ratings Program. The AMCA Certified Ratings Seal applies to Water Penetration and Air Performance Ratings only.



IMPACT RESISTANT LOUVER
Basic Protection Level D

See www.AMCA.org for all certified or listed products

This label does not signify AMCA performance certification.

Louvers & Dampers certifies that the Model IL69 shown herein is approved to bear the AMCA Listing Label. The ratings shown are based on tests and procedures performed in accordance with AMCA Publications and comply with the requirements of the AMCA Listing Label Program.

The AMCA Listing Label applies to Wind Borne Debris Impact Resistant Louvers.

