

PH12 (Phantom 12) Series

Unheated

Model Lengths: 42"–144"

Environmental Separation (up to 16')

Insect Control (up to 14')



atmosphere is everything

14716 S. BROADWAY, GARDENA, CA 90248 • Ph: (310)532-1555 • Fax: (310)-532-3030 • www.marsair.com

© Copyright Mars Air Systems, LLC 2014

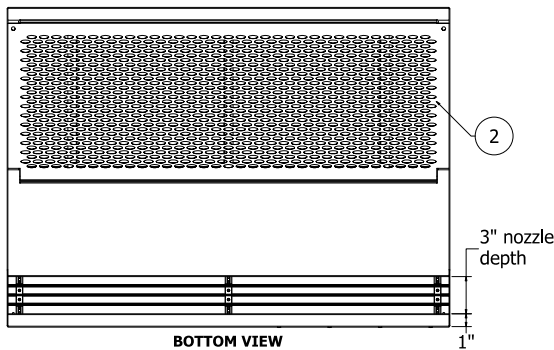
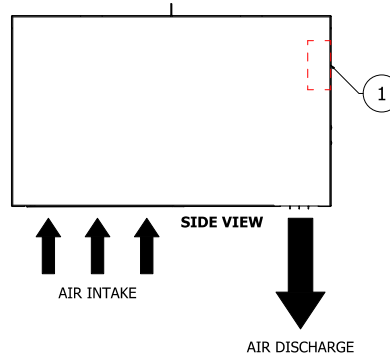
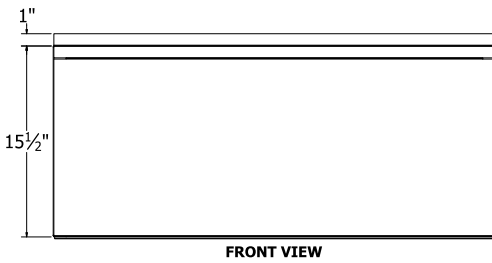
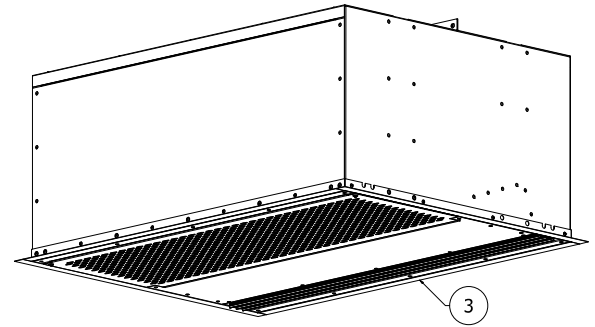
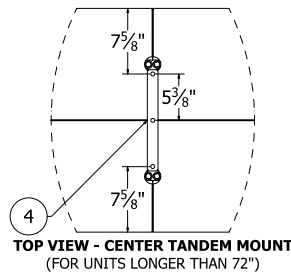
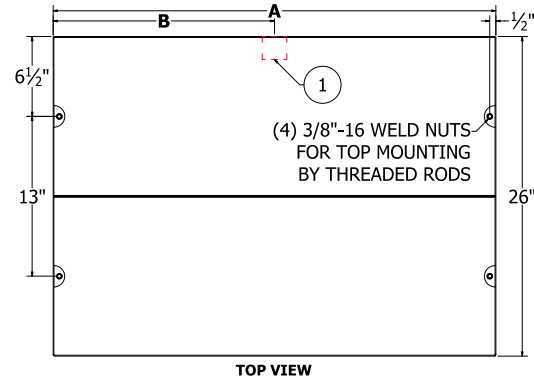

Notes:

1. Internal junction box (j-box) provided for electrical wiring.
2. Cleanable polyester filters are installed standard. Optional washable aluminum or pleated paper filters are also available.
3. (4) 1" wide matching trim pieces are included and shipped loose for optional installation.
4. Units up to 72" in width can be suspended from both ends without intermediate support. Longer units are double units and must be supported in the center.
5. Recommended service clearances are 2" to the left and right sides and 18" on top of the unit.
6. Circuit protection (per NEC) to be installed by others.
7. To prevent accidental damage during operation, unit must be installed so that the bottom of the air curtain does not extend below the door header.

Model Number	Mechanical Data					AMCA Certified Lab Data				
	Overall Length A (in)	Nozzle Length (in)	J-box Distance from Each Edge B (in)	Motor (hp)	Weight (lb)	Max Core Velocity at Nozzle (in)	Avg Velocity (fpm)	Volume (cfm)	Uniformity (%)	Power Rating (watt)
<input type="checkbox"/> PH1236-1U*-PW	36	26	18	1	85	6050	3097	2323	91	1158
<input type="checkbox"/> PH1242-1U*-PW	42	42	21	1	90	6300	2824	2471	90	1259
<input type="checkbox"/> PH1248-1U*-PW	48	48	24	1	90	6450	2534	2534	89	1343
<input type="checkbox"/> PH1272-2U*-PW	72	72	36	(2) 1	155	6050	3097	4646	91	2316
<input type="checkbox"/> PH1284-2U*-PW	84	84	(2) 21	(2) 1	175	6300	2824	4942	90	2518
<input type="checkbox"/> PH1296-2U*-PW	96	96	(2) 24	(2) 1	180	6450	2534	5068	89	2686
<input type="checkbox"/> PH12144-4U*-PW	144	144	(2) 36	(4) 1	310	6050	3097	9292	91	4632
<i>The following models are not licensed to bear the AMCA seal</i>										
<input type="checkbox"/> PH1260-1U*-PW	60	60	30	1	95	6750	2207	2759	86	1531
<input type="checkbox"/> PH12120-2U*-PW	120	120	(2) 30	(2) 1	270	6750	2207	5518	86	3062

* – Use corresponding letters in "Electrical Data" column headers (see page 2) to complete the model numbers.

Note: above data is for 60 Hz at 1725 RPM. For 50 Hz, RPM is 1450 with a 17% reduction in performance.

- The AMCA Certified Ratings Seal applies to airflow rate, average outlet velocity, outlet velocity uniformity, velocity project, and power rating at free delivery only.

NOTE: Mars Air Systems, LLC reserves the right to change specifications and product design without notice. Such revisions do not entitle the buyer to corresponding changes, improvements, additions, or replacements for previously purchased equipment.

PH12 (Phantom 12) Series

Unheated

Model Lengths: 42"–144"

Environmental Separation (up to 16')

Insect Control (up to 14')



atmosphere is everything

14716 S. BROADWAY, GARDENA, CA 90248 • Ph: (310)532-1555 • Fax: (310)-532-3030 • www.marsair.com

© Copyright Mars Air Systems, LLC 2014

Standard Features:

- ❖ ETL-certified to conform to UL 507 (US) and CSA 22.2 (Canada) standards for indoor and outdoor use
- ❖ AMCA-certified to AMCA 211
- ❖ Sleek self-contained one-piece heavy-gauge corrosion-proof paint lock metal design
- ❖ Rust preventative electrostatic polyurethane powder coating
 - Standard color is Pearl White (PW)
- ❖ ½ HP continuous duty Totally Enclosed Air Over (TEAO) motors (NEMA 1)
- ❖ Adjustable air directional vanes with 40° sweep front to back
- ❖ 5-year parts warranty
- ❖ Freight included (FOB continental USA)
- ❖ Proudly made in the USA

Mars Recommended Accessories (see catalog for complete listing):

- ❖ **Door Limit Switches** (§)
 - 99-014, Combination mechanical switch, 250V, 1HP Max
 - 99-125, Industrial surface mounted magnetic switch (controller required)
 - ❖ **Controllers**
 - MCPB-†U*, **Motor Control Panel**, 120V control voltage († = # of Motors, * = Voltage Code) (§)
 - MCP-TD, Adjustable time delay, 1sec-100hr (panel required)
 - MCP-24V, Low voltage control option (panel required)
 - BMS-303, BMS for monitor and control (panel with MCP-24V required)
 - Note:** Dry contact provided in panel for monitoring motor. 24Vac signal provided from panel for controlling motor.
 - SK-URV, SimpleLink, 115V-575V, 4Mtr (1.5HP max @ 115V), Integral Control, Remote VFD for 3Ø, NEMA 1, requires protection from direct elements for outdoor use
 - ❖ **Severe Duty and Finish**
 - HSG-304SS-PH, 304 Stainless steel housing construction
- (§) = Shipped loose

Sound Levels (measured at 10' in a free field):

1 Motor Unit = 70 dBA, 2 Motor Unit = 73 dBA, 3 and 4 Motor Unit = 75 dBA

Electrical Data Full Load Amp (FLA)	Unit Amperage (Voltage Code)					
	Single Phase			Three Phase		
	115V/1Ø □ (A)	208-230V/1Ø □ (D)	208-230V/3Ø □ (G)	460V/3Ø □ (H)	575V/3Ø □ (I)	
<input type="checkbox"/> PH1236-1U*-PW	9.0	5.0	3.3/3.2	1.6	1.3	
<input type="checkbox"/> PH1242-1U*-PW	9.0	5.0	3.3/3.2	1.6	1.3	
<input type="checkbox"/> PH1248-1U*-PW	9.0	5.0	3.3/3.2	1.6	1.3	
<input type="checkbox"/> PH1260-1U*-PW	9.0	5.0	3.3/3.2	1.6	1.3	
<input type="checkbox"/> PH1272-2U*-PW	18.0	10.0	6.6/6.4	3.2	2.6	
<input type="checkbox"/> PH1284-2U*-PW	18.0	10.0	6.6/6.4	3.2	2.6	
<input type="checkbox"/> PH1296-2U*-PW	18.0	10.0	6.6/6.4	3.2	2.6	
<input type="checkbox"/> PH12120-2U*-PW	18.0	10.0	6.6/6.4	3.2	2.6	
<input type="checkbox"/> PH12144-4U*-PW	36.0	20.0	13.2/12.8	6.4	5.2	

* – Use corresponding letters in "Voltage Code" column headers to complete the model numbers.

Ampacity (MCA) = total FLA x 1.25

Alternate voltage codes with FLA data:

- 277V/1Ø/60Hz (L) – 2.7A per motor
- 220V/1Ø/50Hz (U) – 2.5A per motor
- 380-415V/3Ø/50Hz (W) – 1.1A per motor

AMCA Certified Projection Velocity		
Model	Distance from Nozzle (in)	Average Core Velocity (fpm)
PH1236-1U*	40	2039
	80	1217
	120	1122
	160	1033
	200	983

EXAMPLE

PH12 72 -2 U H -PW

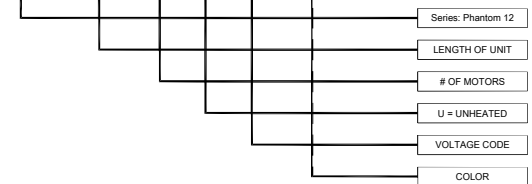

MARS Air Systems, LLC certifies that the Air Curtains shown on this data sheet are licensed to bear the AMCA seal. The ratings shown are based on tests and procedures performed in accordance with AMCA Publication 211 and comply with the requirements of the AMCA Certified Ratings Program. The AMCA Certified Ratings Seal applies to airflow rate, average outlet velocity, outlet velocity uniformity, velocity projection and power rating at free delivery only. NOTE: Models PH1260-1 and PH12120-2 are not AMCA-certified.

NOTE: Mars Air Systems, LLC reserves the right to change specifications and product design without notice. Such revisions do not entitle the buyer to corresponding changes, improvements, additions, or replacements for previously purchased equipment.