

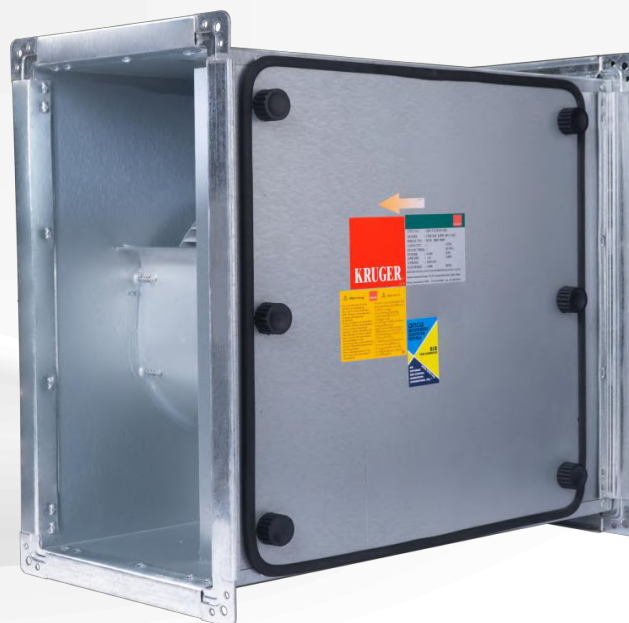

CSD Series Cabinet Fan

Inline Centrifugal Cabinet Fan



- ✖ Compact
- ⚙ Easy to Maintenance
- 🔊 Low Noise

Why KRUGER?

KRUGER has been a leading innovator and manufacturer of residential, commercial and industrial fan application solutions across Asia since 1985. Today with a direct presence in over 18 regions throughout Asia; world class R&D and manufacturing facilities; KRUGER are able to offer their customers unparalleled service and support at a local level. Our customers place their trust in KRUGER.



What is a KRUGER CSD Inline Centrifugal Cabinet Fan?

The CSD series is a single inlet centrifugal inline fan designed for supply, exhaust and pressurization in general clean air application with CL-F insulation motor. It is compact, generates high pressure and low noise.

Why use a KRUGER CSD Cabinet Fan?

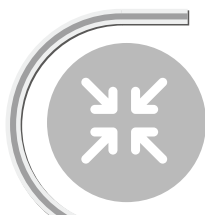

Compact size

Smaller footprint/space >>>> **More usable area for occupants**

CSD series compact size cabinet require smaller for installation and it could be installed above ceiling.

Low noise

Installation near occupant >>>> **Flexible installation location**

KRUGER CSD Series offer one of the lowest noise /CMH in the industry.



Easy to maintenance

Direct without the belt, bearing and sheaves >>>> **Lower maintenance cost**

CSD fan impeller is directly mouted to motor shaft, eliminate the loss due to drive transmission, require less fan parts and no maintenance needed.

Summary of Key Standard CSD Series Specifications

A Airflow and static pressure up to 7,000 CMH and 750 Pa.

B Airstream Operating Temperatures
Clean air standard ventilation application
-20°C to +40°C.

C Certifications



Kruger* certifies that the CSD series shown herein is licensed to bear the AMCA Seal. The ratings shown are based on tests and procedures performed in accordance with the AMCA publication 211 and comply with the requirements of the AMCA Certified Ratings Program.

- *Kruger Ventilation Industries Asia Co. Ltd.
- *Shanghai Kruger Ventilation Co. Ltd.
- *Tianjin Kruger Ventilation Co. Ltd.
- *Wuhan Kruger Ventilation Co., Ltd.
- *Kruger Ventilation Industries (India) Pvt. Ltd.
- *P.T. Kruger Ventilation Indonesia
- *Kruvent Industries (M) Sdn. Bhd.
- *Kruger Ventilation Industries (Thailand) Co. Ltd.
- *Kruger Ventilation Industries (Vietnam) Co., Ltd.

D Cabinet

With high gloss surface finished manufactured from ZERO spangle galvanized steel.

E Single Width Forward Curved Wheel

Wheel manufactured in high gloss surface finished manufactured from ZERO spangle galvanized steel. All wheels are statically and dynamically balanced to G2.5 in accordance with ISO 21940.

F Modularized Cabinet Design

INSTALL & SERVICE-FRIENDLY, removable access panel on both sides for easy access to fan and motor.

G Duct Collars/L-Inlet and Outlet Fan



Options and Accessories

- H** : Flexible Duct
- J** : Isolators

Typical Applications



Office



Toilet

Technical Data

IP21 Motor Models

Model	Max Q (m ³ /h)	Max Ps (Pa)	Motor Installed Power (W)	Maximum Motor Input Power (W)	Motor Protection	Phase	Pole	Hz	Maximum Current (A)	Voltage (V)	Capacitor (μF/V)	Insulation Class	Lp (A) at 3m free discharge (dB (A))*	Speed (RPM)	Motor Model Number
CSD 200 4P-1 1SY	845	245	165	222	IP21	1	4	50	0.9	230	7.5/450	F	49	1440	F3MC7317
CSD 225 4P-1 1SY	1080	450	245	348	IP21	1	4	50	1.6	230	7.5/450	F	49	1370	F3MC7315
CSD 250 4P-1 3SY	1870	535	350	708/520/363	IP21	1	4	50	3.0/2.3/1.7	230	12.5/450	F	49	1300/1150/1050	F3MC7316
CSD 280 4P-1 3SY	2590	585	550	1154/976/842	IP21	1	4	50	5.2/4.3/3.8	230	12.5/450	F	53	1300/1250/1150	F3MC7308
CSD 315 4P-1 3SY	2940	755	750	1736/1512/1265	IP21	1	4	50	6.5/5.5/4.9	230	12.5/450	F	54	1300/1250/1150	F3MC7324
CSD 315 6P-1 3SY	3160	395	709	855/742/494	IP21	1	6	50	4.6/3.6/2.6	230	12.5/450	F	54	950/850/750	F3MC7309

IP44 & IP55 Motor Models

Model	Max Q (m ³ /h)	Max Ps (Pa)	Motor Installed Power (W)	Maximum Motor Input Power (W)	Motor Protection	Phase	Pole	Hz	Maximum Current (A)	Voltage (V)	Capacitor (μF/V)	Insulation Class	Lp (A) at 3m free discharge (dB (A))*	Speed (RPM)	Motor Model Number
CSD 200 4P-1 1SC	800	221	165	210	IP44	1	4	50	0.9	230	7.5/450	F	49	1440	F3MC7317
CSD 225 4P-1 1SC	1005	376	245	306	IP44	1	4	50	1.4	230	7.5/450	F	49	1380	F3MC7315
CSD 250 4P-1 3SC	1765	533	350	673/493/356	IP44	1	4	50	2.8/2.2/1.6	230	12.5/450	F	49	1350/1270/1150	F3MC7316
CSD 280 4P-1 3SC	2160	672	550	854/707/649	IP44	1	4	50	3.8/3.1/2.9	230	12.5/450	F	53	1350/1270/1150	F3MC7308
CSD 315 6P-1 3SC	2630	397	709	713/537/381	IP44	1	6	50	3.8/2.8/1.9	230	12.5/450	F	55	940/830/750	F3MC7309
CSD 355 6P-3 1SC	4380	453	1100	2205	IP55	3	6	50	3.1	400	-	F	55	950	MK270C
CSD 400 6P-3 1SC	7045	533	1500	3162	IP55	3	6	50	5.2	400	-	F	55	910	MK280C

- Performance certified is for installation type D – Ducted inlet, Ducted outlet.
- Performance ratings do not include the effects of appurtenances (accessories).
- Speed (RPM) shown is nominal. Performance is based on actual speed of test.
- Lp(A) at 3m free discharge dB(A) levels are not licensed by AMCA International.

Dimension

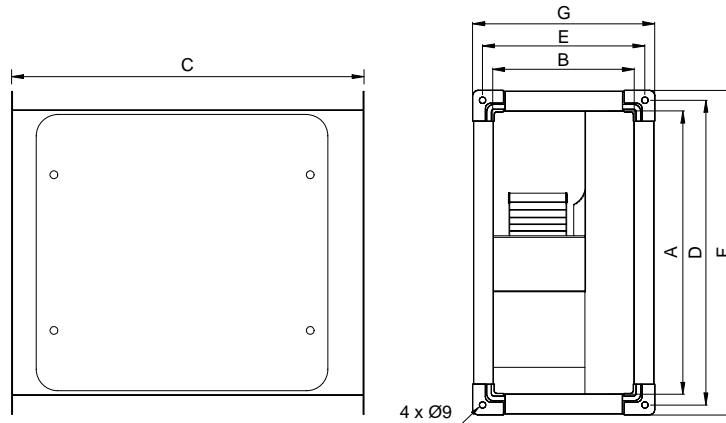

Model	A	B	C	D	E	F	G	Wt(kg)
CSD 200	400	200	500	431	232	459	260	15
CSD 225	500	250	542	531	282	559	310	19
CSD 250	500	300	562	531	332	559	360	22
CSD 280	600	300	682	631	322	659	360	30
CSD 315	600	350	717	631	382	659	410	42
CSD 355	800	400	800	831	432	859	460	45
CSD 400	800	500	882	831	532	859	560	55

All dimension in mm.

Performance Data

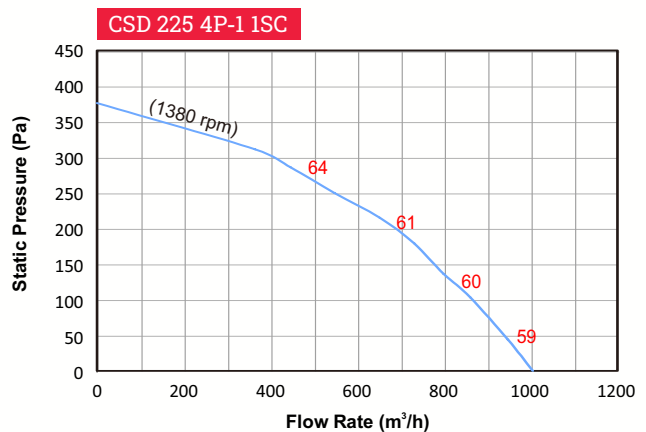
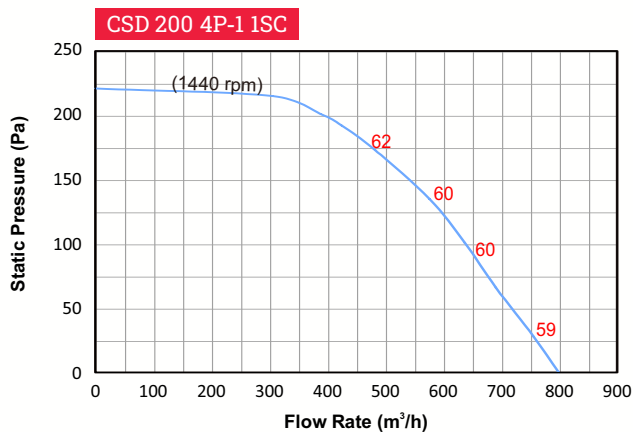
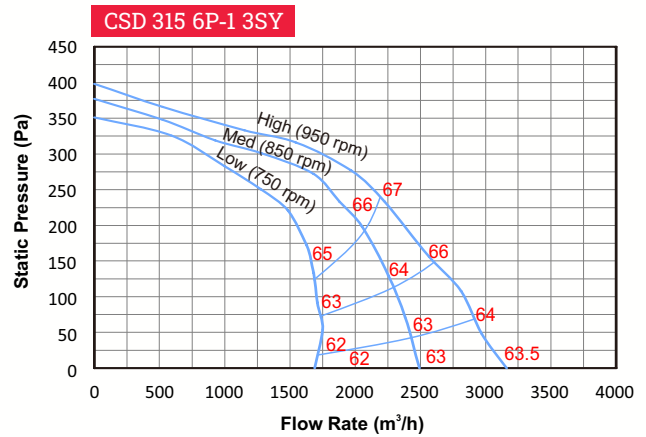
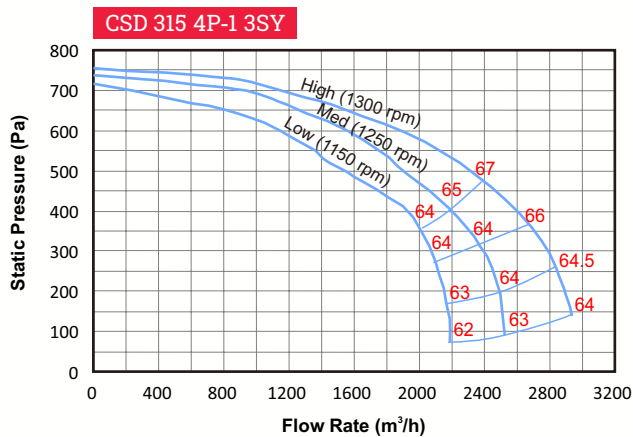
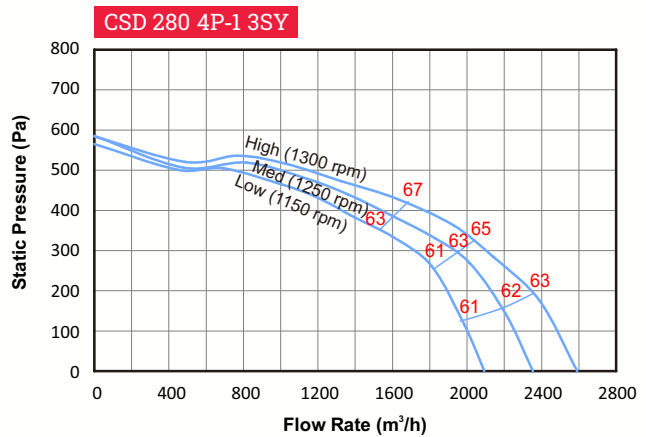
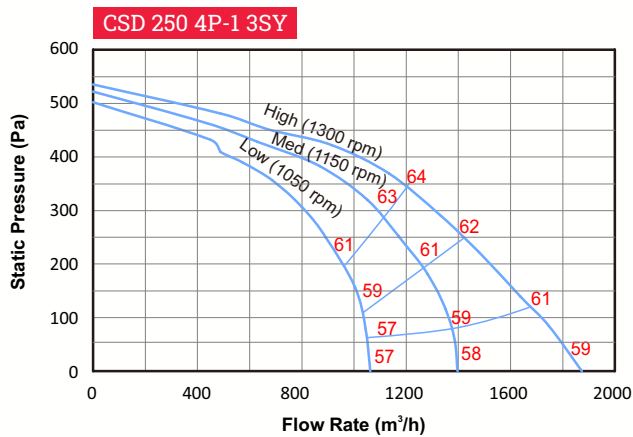
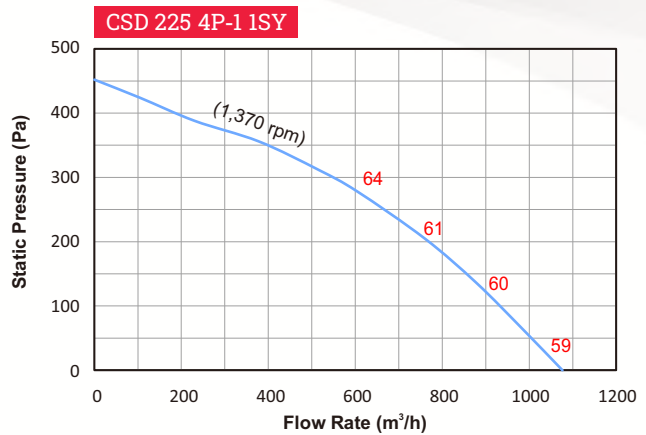
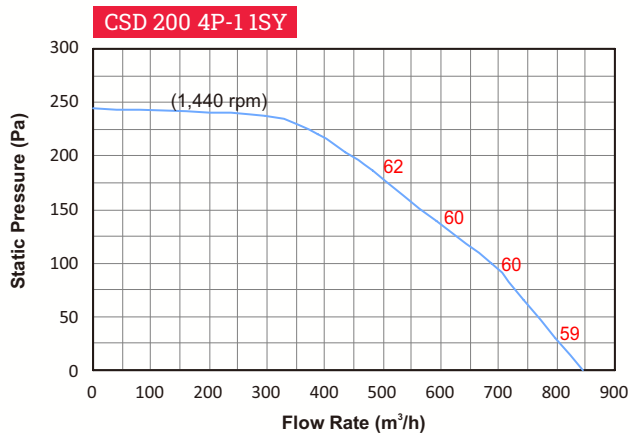

- The AMCA Certified Ratings seal applies to air performance only.
- Sound pressure level Lp(A) at 1m free field.
- Performance certified is for installation type D – Ducted inlet, Ducted outlet.
- Performance ratings do not include the effects of appurtenances (accessories).
- Speed (RPM) shown is nominal. Performance is based on actual speed of test.

Performance Data

CSD 250 4P-1 3SC

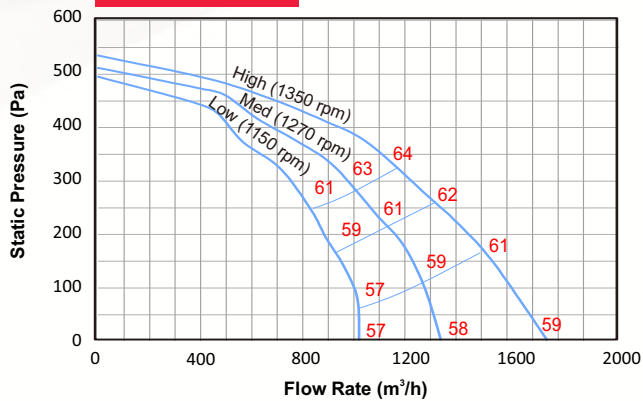

CSD 280 4P-1 3SC

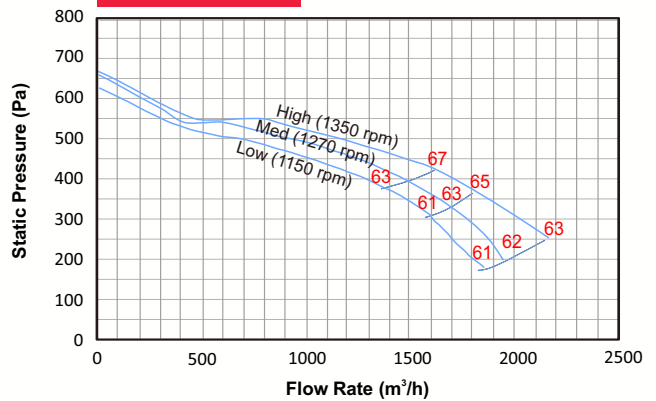

CSD 315 6P-1 3SC

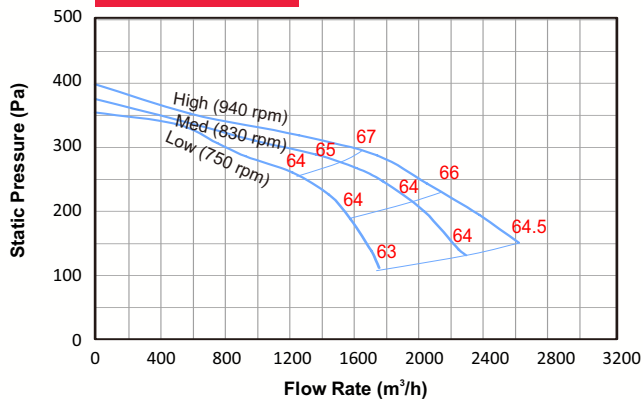

CSD 355 6P-3 1SC

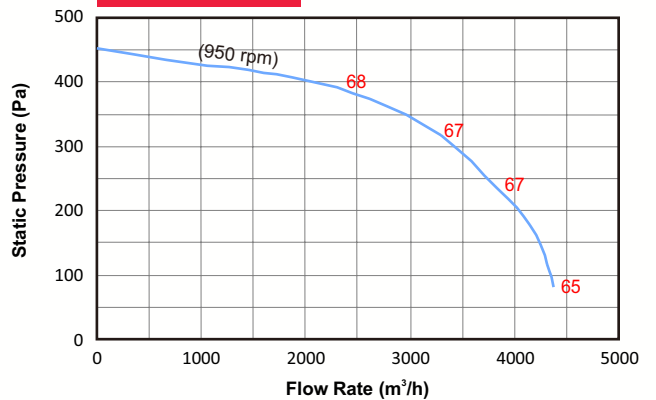

CSD 400 6P-3 1SC

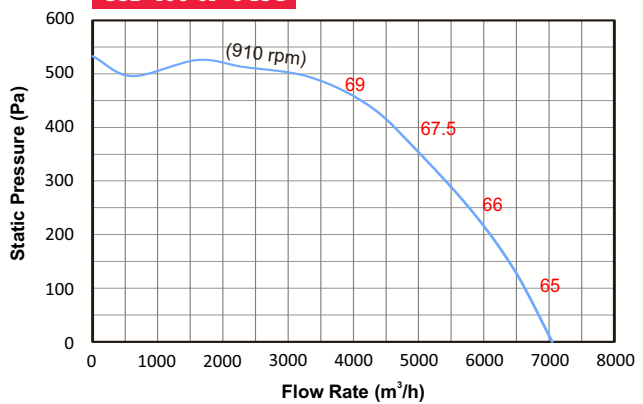

- The AMCA Certified Ratings seal applies to air performance only.
- Sound pressure level Lp(A) at 1m free field.
- Performance certified is for installation type D – Ducted inlet, Ducted outlet.
- Performance ratings do not include the effects of appurtenances (accessories).
- Speed (RPM) shown is nominal. Performance is based on actual speed of test.

KRUGER Ventilation Group

THAILAND (Regional HQ)

KRUGER VENTILATION INDUSTRIES ASIA CO. LTD.
30/159 Moo 1, Sinsakorn Industrial Estate,
Chetsadawithi Road, Khok Kham Mueng, Samuthsakorn 74000, Thailand
Tel: +662 1054298 Fax: +662 0248256-9
Website: www.krugerfan.com

THAILAND

KRUGER VENTILATION IND. (THAILAND) CO. LTD.
30/105 Moo 1, Sinsakorn Industrial Estate,
Chetsadawithi Road, Khok Kham Mueng, Samuthsakorn 74000, Thailand
Tel: +662 1050399 Fax: +662 1050370-2
Email: mktg@kruger.co.th

INDIA

KRUGER VENTILATION INDUSTRIES (INDIA) PVT. LTD.
Kruger Centre, Mumbai-Nasik Highway,
Kalamgaon, Shahapur, Thane 421601, Maharashtra, India
Tel: +91 996055899/9975577211
Email: sales@krugerindia.com

MIDDLE EAST

CONTACT: KRUGER VENTILATION INDUSTRIES (INDIA) PVT. LTD.
Tel: +91 9766323730 / +91 9975577211
Email: rahul@krugerindia.com

INDIA (NORTH)

KRUGER VENTILATION INDUSTRIES (NORTH INDIA) PVT LTD
Village Rohad, Tehsil Bahadurgarh, Hajar, Haryana-124507
Tel. +91-9958991652/9958991660/8586966303
Fax +91-1276-278096
Email: sales.kni@krugerindia.com , service@krugerindia.com

KOREA

NEOMATE CO. LTD.
2-1010, Ace High Tech City B/D, 775 Gyeongin-ro,
Yeongdeungpo-gu, Seoul, Korea. Postal Code 07299
Tel: +82-2-2679-2052 Fax: +82-2-2679-2174
Email: y7890@neomate.co.kr

MYANMAR

KRUGER VENTILATION (MYANMAR) CO. LTD.
Room No. F21, Thiri Yadanar Whole Sale Market, (Htawunbe)
Toe Chae Ward, North Okkalapa Township, Yangon.
Tel: +959 763141081/2/3
Email: htoon@krugermm.com

SINGAPORE

KRUGER ENGINEERING PTE. LTD.
2 Venture Drive #20-23, Vision Exchange,
Singapore 608526.
Tel: +65 68631191 Fax: +65 68631151
Email: mktg@krugerfan.com

AUSTRALIA

S&P KRUGER AUSTRALIA PTY. LTD.
2 Cunningham St, Moorebank N.S.W. 2170
Tel: +61 2-98227747
Fax: +61 2-98227757
Email: info@sandpkruger.com.au

INDONESIA

P.T. KRUGER VENTILATION INDONESIA.
JL. Teuku Umar No.20,
Karawaci - Tangerang 15115, Indonesia
Tel: +62 21-5512288/5513557 Fax: +62 21-5513502
Email: mktg@krugerindo.co.id

CHINA (GUANGZHOU)

GUANGZHOU KRUGER VENTILATION CO. LTD.
No. 9 Huahui Road, Huashan, Huadu,
Guangzhou, P.R. China 510880
Tel: +86 20-66356635 Fax: +86 20-86786001/86786500
Email: gzkruger@krugergz.com

CHINA (TIANJIN)

TIANJIN KRUGER VENTILATION CO. LTD.
Jingjin Science and Technology Park
Wuqing District, Tianjin, China
Tel: +86 22-22143480/3481 Fax: +86 22-22143482
Email: krugertj@krugertj.com

CHINA (SHANGHAI)

Shanghai Kruger Ventilation Co.,Ltd.
No.500 Yuanguo Road, Anting, Jiading District,
Shanghai 201814, P.R. China
Tel: +86 21-69573266 Fax: +86 21-69573296
Email: shkruiger@krugerchina.com

CHINA (WUHAN)

WUHAN KRUGER VENTILATION CO. LTD.
No. 805, Huian Ave, Dongxihu District, Wuhan, Hubei, P.R. China 430040
Tel: +86 27- 83248840/83060522/83097505
Fax: +86 27- 83261886
Email: whkruger@krugerwh.com

HONG KONG

KRUGER VENTILATION (HONG KONG) LIMITED.
Flat C, 9/F, Yeung Yiu Chung (No.8) Industrial Building,
20 Wang Hoi Road, Kowloon Bay, Kowloon, Hong Kong
Tel: +852 22469182 Fax: +852 22469187
Email: info@kruger.com.hk

TAIPEI

KRUGER VENTILATION (TAIWAN) CO. LTD.
No. 157, Ping-an Rd, Hengfeng Village,
Dayuan Shiang Taoyuan County 337, Taiwan
Tel: +886 3-3859119 Fax: +886 3-3859118
Email: sales@krugertwn.com.tw

MALAYSIA

KRUVENT INDUSTRIES (M) SDN. BHD.
Lot 850, Jalan Subang 7, Taman Perindustrian Subang,
47500, Subang Jaya, Selangor D.E.
Tel: +603 80743399 Fax: +603 80743388
Email: mktg@kruger.com.my

PHILIPPINES

KRUGER M & E INDUSTRIES CORP.
B3 Welborne Industrial Park
Banca Carmona Cavite 4116, Philippines
Tel: +63-917-561-9088 / +63-917-596-7288
+63-917-712-8438 / +63-917-306-8288
Email: mktg@krugerph.net

VIETNAM

KRUGER VENTILATION INDUSTRIES (VIETNAM) CO. LTD.
Lot A7. 2-4, C2 Road, Thanh Thanh Cong IZ,
Trang Bang Dist. Tay Ninh Province, Vietnam
Tel: +84-276 3585200/01/02 Fax: +84-276 3585199
Email: mktg@krugervn.com



Kruger Ventilation Industries Asia Co., Ltd.

30/159 Moo 1, Sinsakorn Industrial Estate
Chetsadawithi Road, Khok Kham Mueng,
Samuthsakorn 74000, Thailand

Tel: +662 1054298 Fax: +662 0248256-9

Website: www.krugerfan.com

CAT054.E0 February 2023

A member of

