

Axial Fans JM Aerofoil Catalogue (60Hz)

WAM_DC_00073GB_60HZ JM AEROFOIL
January 2024

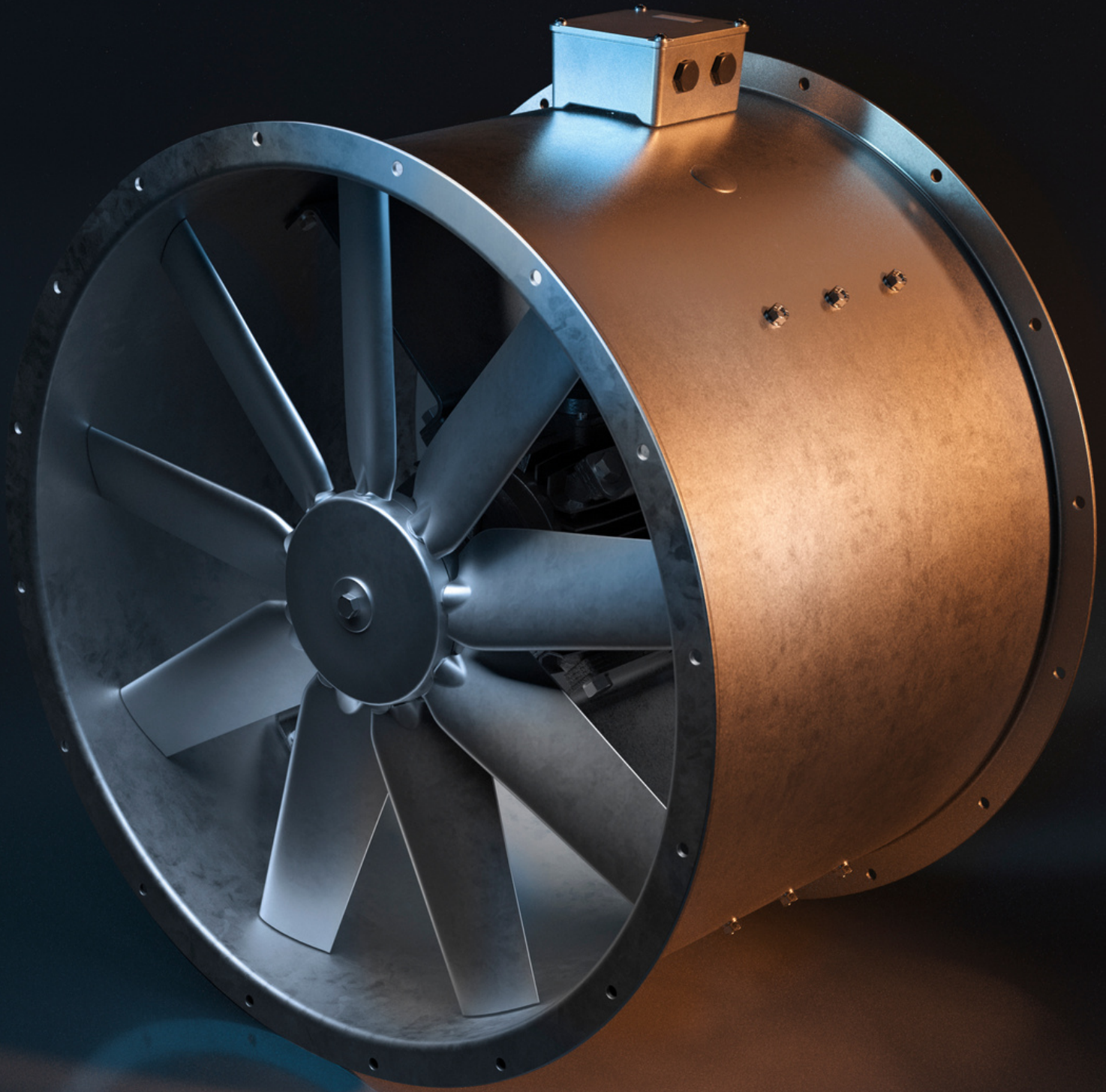



CONTENTS PAGE

Company Overview	1-3
How To Order	4
Ancillaries	4
Specification	5-6
Guide To Fan Selection	
- Total Pressure	7-8
- Static Pressure	9-10
Performance Curves	11-136
Useful Information	137

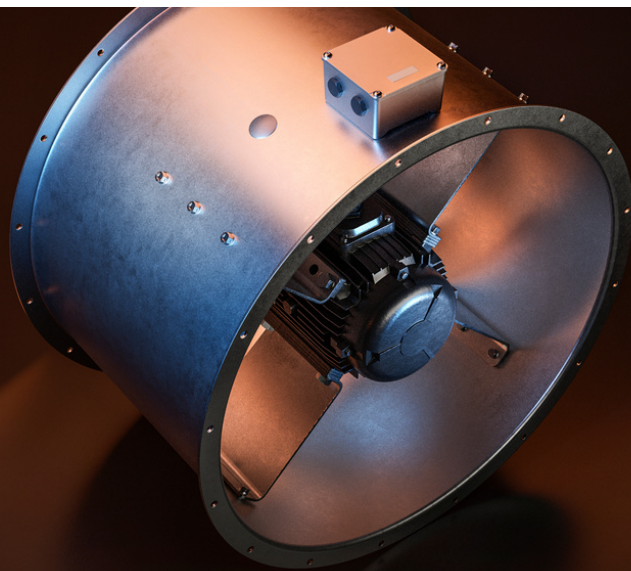

Building on more than 100 years of innovation

Woods was founded in 1909 in Colchester, United Kingdom. We began as manufacturers of small electric motors and introduced a range of propeller fans in the 1920s.



Over the years, Woods concentrated more on the design and manufacture of axial fans, developing the first aerofoil blade design, while still continuing to design and manufacture motors. This continuous development has evolved into one of the world's largest ranges of certified axial fans for almost any application imaginable including fire safety, ventilation, industrial process, oil and gas and marine.

Woods was merged with Fläkt in 2002 to create Fläkt Woods. In 2020, Fläkt Woods changed their trading name to Woods Air Movement under FläktGroup holdings and opened offices in the United States of America and Germany.

Woods has over 100 years of experience and knowledge in designing axial flow fans and remains a distinct brand within the FläktGroup family.



1909



1947



1942

1950



2004



2006

2016



2020

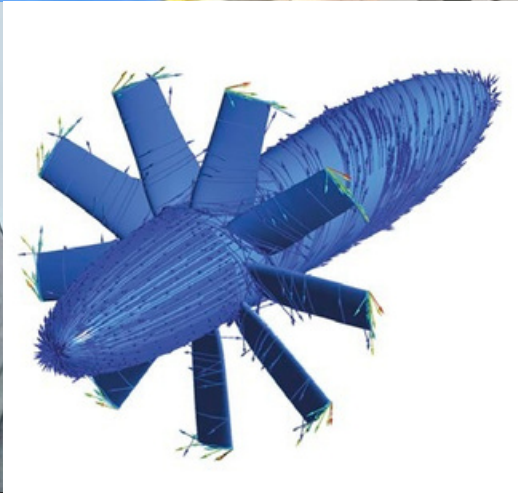

OUR FOOTPRINT

Our head office is situated in Colchester in the United Kingdom with the state of the art (16.500 sqm) factory to produce around 100000 fans annually for the global market. We also have a factory and office in the United States of America and an office situated in Germany. In India we have installed one of the first test rigs in the country. Our products are distributed and reach various markets globally, through strong partnerships with over 70 international distributors and agents.

A complete fan range from Woods Air Movement

We manufacture the most reliable and best quality air movement and ventilation products for a wide range of applications and industries. Our state of the art production facilities operate under rigorous process controls, providing reassurance that the products will continue to perform faultlessly throughout their design life.

Most of our product range is available for dual use normal/emergency high temperature operation, please contact one of our sales team members for more technical information. If our products still do not meet your requirements then we have in-house capabilities to assist with designing, engineering and manufacturing the perfect solution for you.

ENSURING THE BEST POSSIBLE QUALITY IN EVERY DETAIL

- We ensure our products follow the ISO1940 Balance standards and Vibration BS848 pt 7 ISO14694.
- Manufactured in a site that is ISO 9001 & 14001 accredited.

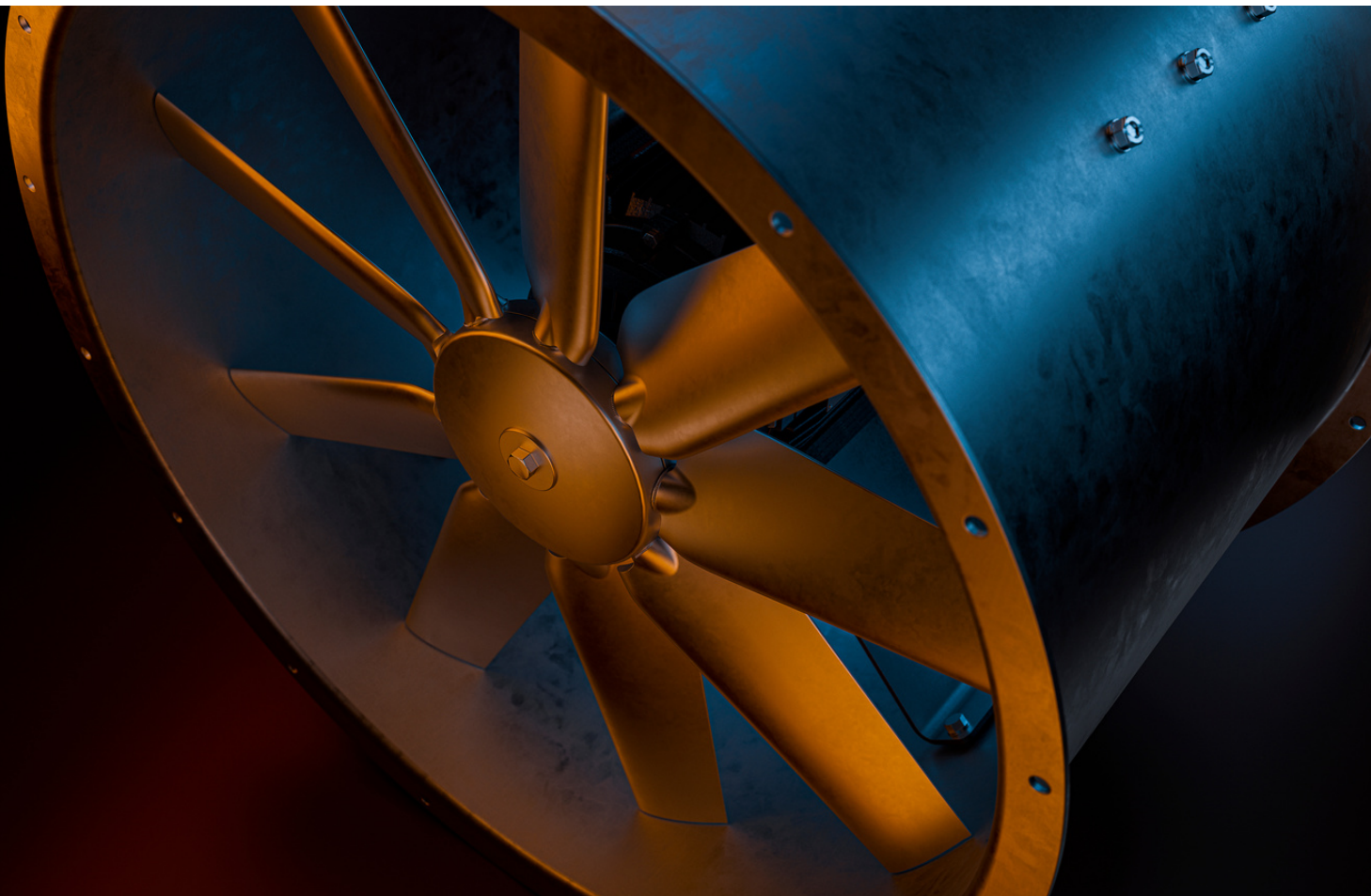

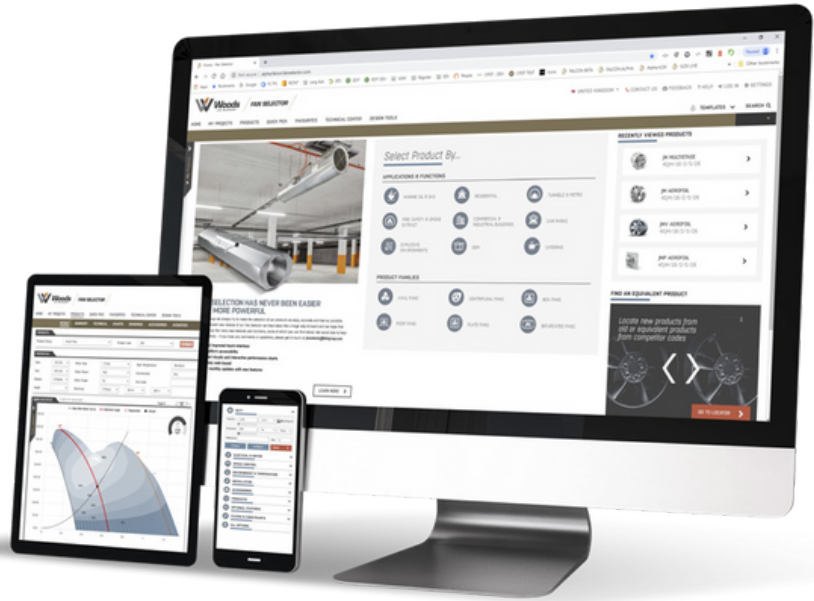

PRODUCT SELECTION AND CONFIGURATION HAS NEVER BEEN EASIER – OR MORE POWERFUL

We always try to make the selection of our products as easy, accurate and fast as possible. With the brand new release of our Fan Selector we have taken a huge step forward and we hope that you will enjoy the many new features and functions – including web-based multi-platform accessibility with touch interface and interactive performance charts.

HOW TO ORDER

Just provide us with fan selector datasheets (to confirm your product requirements) and your delivery requirements.

AXIAL ACCESSORIES

All accessories are available via our online Fan Selector.

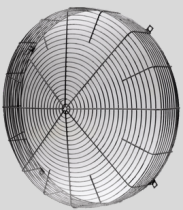

Safety Guard



Bellmouth Inlet

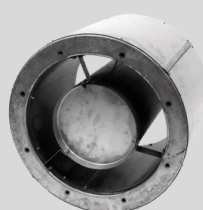

Silencer



Air Operated Damper



Matching Flange

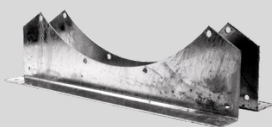

Mounting Feet



A/V Mounts



Flexible Connector and Clips

JM AXIAL FAN SPECIFICATION SHEET



RANGE FEATURE SUMMARY

- 15 diameters available, 315 to 1600 mm
- Flow rates up to 234,000 m³/h (65 m³/s)
- Static pressures up to 2000 Pa
- Fans tested to ISO 5801 and ISO 5136
- High efficiency design to minimise running costs
- Low installed noise levels
- Motor protection IP55
- Hot dip galvanised casing

IMPELLER

BLADE DESIGN: Woods' AEROFOIL blades incorporate bespoke aerodynamic profiles that are optimised to provide high levels of performance and efficiency with minimal noise generation whilst providing a robust mechanical design.

HUB DESIGN: Profiled hub and clamp-plates are used to retain the blades, whilst permitting blade angle adjustment when the impeller is at rest. Hubs are fitted with an integral steel insert to provide a resilient interface with the motor drive shaft.

STRUCTURAL DESIGN: Impellers are designed with a minimum safety factor of 2.0 when performing within their qualified operating range.

MANUFACTURE: Hub and blade components are precision die cast, or for larger fan diameters, have gravity cast components, using aluminium alloys that have a high levels of strength/weight ratio and provide excellent corrosion resistance. All impeller components undergo real time X-ray inspection to assure structural integrity.

BALANCE: In accordance with ISO 14694, Grade G16 to G2.5, depending on rated motor power.

FORM OF RUNNING: Form B: Airflow through impeller then over the motor (as standard). Form A with airflow over the motor then through the impeller is also available.

IMPELLER LOCATION AND FIXING: Impellers are located on the motor drive shaft by a retaining washer and screw fitted into a tapped hole in the end of the shaft and positively secured with either locking compound or mechanical fixing. Torque transfer is by a key and keyway manufactured in accordance with BS 4235:1972.

NON-OVERLOADING: JM Aerofoil fans have a non-overloading characteristic; the peak power input occurs within the range of normal operating pressures and is always exceeded by the motor rating.

FAN CASING

MATERIAL: Casings are manufactured from mild steel to BS EN 10111 Grade DD11.

CASING DESIGN: With integral pre-drilled flanges and fully welded seams. Casing and flange thickness varies depending on fan diameter and motor size. Long cased configurations enclose the entire length of the impeller and motor assembly and are complete with a duct mounted terminal box and inspection port. A rubber moulding is fitted to the port.

Short cased configurations where the motor extends beyond the casing are available without a terminal box or sight port. Electrical connection is made directly to the motor.

CASING FINISH: Hot dip galvanised after manufacture to BS EN ISO 1461.

CONNECTION FLANGES: Flanges are an integral part of the fan casing and feature fixing holes that are equi-spaced around a pitch circle diameter to facilitate connection to duct work in accordance with BS EN ISO 13351.

MOTOR

TYPE: Fan motors are of the totally enclosed, squirrel cage induction, S1 continuous duty type.

MOTOR RATINGS: Woods uses integrated fan motors where the ratings are determined in full accordance with IEC 60034-1 when the motor is installed in the fan. Most motors are classed IC 418 according to IEC 60034-6 and therefore cannot be operated when separated from the fan unless a derated TENV rating is applied.

TWO SPEED: Pole Change (also known as PC or Dahlander) motors operate at one of two speeds by reconnecting a single winding via six winding terminals to create the required pole configuration. Dual Wound motors have two separate individual windings of the requisite poles to achieve the required speeds.

JM AXIAL FAN

SPECIFICATION SHEET

ELECTRICAL SUPPLY: Single and three phase motors are available.

220-240 V 60 Hz single phase (1Ø)

400 V 60 Hz three phase (3Ø)

440-480 V 60 Hz three phase (3Ø)

(Other voltages and 50 Hz variants are available on request). Single phase motors are of the capacitor start and run type. All motors are capable of withstanding direct online starting.

SPEED CONTROL: All three phase, single speed motors are suitable for inverter control. Transformer or electronic control options are also available for some smaller frame sizes.

BEARINGS: Either ball or roller type bearing with an L10 design life of at least 20,000 hours when calculated using ISO 281 for rated fan duty.

MOTOR FINISH: Aluminium self-finish or Cast iron painted to motor manufacturers specification.

INGRESS PROTECTION: IP55 with drain plug fitted.

TERMINAL BOXES: Where fitted, all terminal boxes shall have the same level of protection as the motor.

STANDARD TEMPERATURE FANS: Fans are designed for continuous operation from -40°C to +50°C, with motors suitable for starting at temperatures above -20°C.

PERFORMANCE DATA

Fan performance data is derived from tests conducted in the Woods' laboratory (accredited by AMCA in accordance with ISO 5801) and is intended for fully ducted, type D configurations.

Acoustic data is derived from tests conducted in the Woods' laboratory in accordance with ISO 5136 specifically for ducted conditions.

REVERSAL OF AIRFLOW

Woods Air Movement has developed the JM Aerofoil to provide optimum aerodynamic and acoustic performance.

As well as achieving enhanced performance, the development process has established the operational limits of the impellers in all circumstances.

Stress measurements have been conducted when operating in both forwards and reverse modes in order to determine the maximum speeds for continuous operation.

This also involved extensive testing of the materials in order to establish relationships between life, operational stresses and casting quality.

Since the stresses experienced in the reverse mode are generally higher than those in forward operation some impeller configurations are not available for reverse operation at maximum speed. In all instances where reverse operation is required, please enquire to confirm suitability.

WARRANTY PERIOD

Our standard warranty period for both the fan and motor is 2 years from date of despatch.

STANDARD ACCESSORIES

BELLMOUTH INLETS

Bellmouth inlets can be provided for long and short cased fans and are spun from mild steel to BS EN 10111 Grade DD11 and hot dip galvanized to BS EN ISO 1461 after manufacture.

INLET/OUTLET GUARD

Inlet and outlet wire guards can be provided where requested and are fabricated from mild steel wire and rod as a welded assembly, which is either hot dip galvanized, or zinc plated after manufacture. Guards are manufactured in accordance with ISO 12499.

FAN MOUNTING FEET

Fans can be provided with attachable feet where requested, suitable for horizontal or vertical mounting, fabricated from mild steel to BS EN 10111 Grade DD11, up to 8mm thick. Feet are hot dip galvanized in accordance with BS EN ISO 1461 after manufacture.

FLEXIBLE CONNECTORS

Flexible connectors can be provided where requested and are fabricated from silicon coated glass fibre fabric. The materials should withstand temperatures up to 400°C/2hrs and be flame resistant, conforming to BS 476-7. Flexible connectors should be fitted using stainless steel worm drive clips.

ANTI-VIBRATION MOUNTS

Two mount variants are available. Rubber in-shear mounts are designed for standard temperature fans, while spring mounts are available for high temperature fans.



Fläkt Woods, Ltd., trading as Woods Air Movement, certifies that the models herein are licensed to bear the AMCA seal. The ratings shown are based on tests and procedures performed in accordance with AMCA Publication 211 and comply with the requirements of the AMCA Certified Ratings Program.



Scan the QR Code to view our AMCA certification.

TOTAL PRESSURE - SELECTION EXAMPLE

There are two principle methods of expressing the pressure requirements, namely, P_F (Total) and P_{SF} (Static) pressure. The two types of pressure are related:

$$P_F = P_{SF} + P_{dF}$$

P_F = Fan Total pressure
 P_{SF} = Fan Static pressure
 P_{dF} = Fan Dynamic pressure

The international convention considers fan performance in terms of total pressure, but there is also established practice relating to the use of static pressure. For this reason Woods' selection charts are laid out on a total pressure major scale and include a secondary grid for static pressure. The facility to display fan performance in terms of static pressure is necessary in order to avoid total pressure fan selections being made based on static pressure system requirements.

The guide selections are made for either total or static pressures of 100Pa. The resulting selections are quite different and highlight the consequences of selecting static pressure from charts that only display performance in terms of total pressure.

PROCEDURE - TOTAL PRESSURE (P_F)

1. Guide to Chart Numbers of Possible Selections
The charts are arranged in order of fan diameter, starting at 315 mm, up to 1600 mm diameter, and in order of fan speed for each diameter, 3, 5, 6, 9 & 12 bladed fan impellers as available.

NOTE: The chart numbers lead to a variety of fan sizes, impeller configurations and speeds. The fan selected from the alternatives available will depend on the most critical factor for the particular application - Volume Flow and Pressure required, Size, Power Consumption, Sound Level or First Cost.

2. Required Duty

Establish the volume flow and total pressure required of an individual fan at Standard Air (1.2 kg/m³).

3. Selection on Individual Fan Charts

The data provided on each performance chart is specifically for ducted - Type D (ducted) installations for both long or short cased (S-type) fans. Provided that reasonable Type D conditions are maintained in the installation of the fans, no additional factors to volume flow or pressure need be incorporated for a suitable selection to be made.

Plot the duty on the selected fan charts to establish blade angle, sound level, absorbed and impeller power.

- D. Duty Point Required - @ Standard Air (1.2kg/m³).
0.55 m³/s @ 100 Pa **total** pressure.
- 1. Volume Flow = 0.55 m³/s
- 2. Fan Total Pressure = 100 Pa
- 3. Overall inlet Sound Power Level = 72 L_w
(Interpolated from surrounding levels).
- 4. Blade Angle required to achieve Duty Point = 28°
- 5. Corrections to overall Sound Power level for 28° Pitch Angle.
(Operating Point is **BELOW** shaded area):-

Sound Power Level	Frequency Hz							
	63	125	250	500	1K	2K	4K	8K
Inlet	65	67	64	65	60	54	51	45 Lw
Outlet	67	70	65	65	60	54	52	46 Lw

- 6. Note that the duty impeller absorbed power for the 28° blade angle = 0.09 kW. To select a suitable motor to cover the full extent of the operating characteristic use our Fan Selection software to confirm the fan selection and obtain the optimum motor.

GUIDE TO FAN SELECTION

TOTAL PRESSURE - SELECTION EXAMPLE

Performance Data ISO 5801

Performances shown is for installations type D - Ducted inlet, Ducted outlet. Performance ratings do not include the effects of appurtenances.

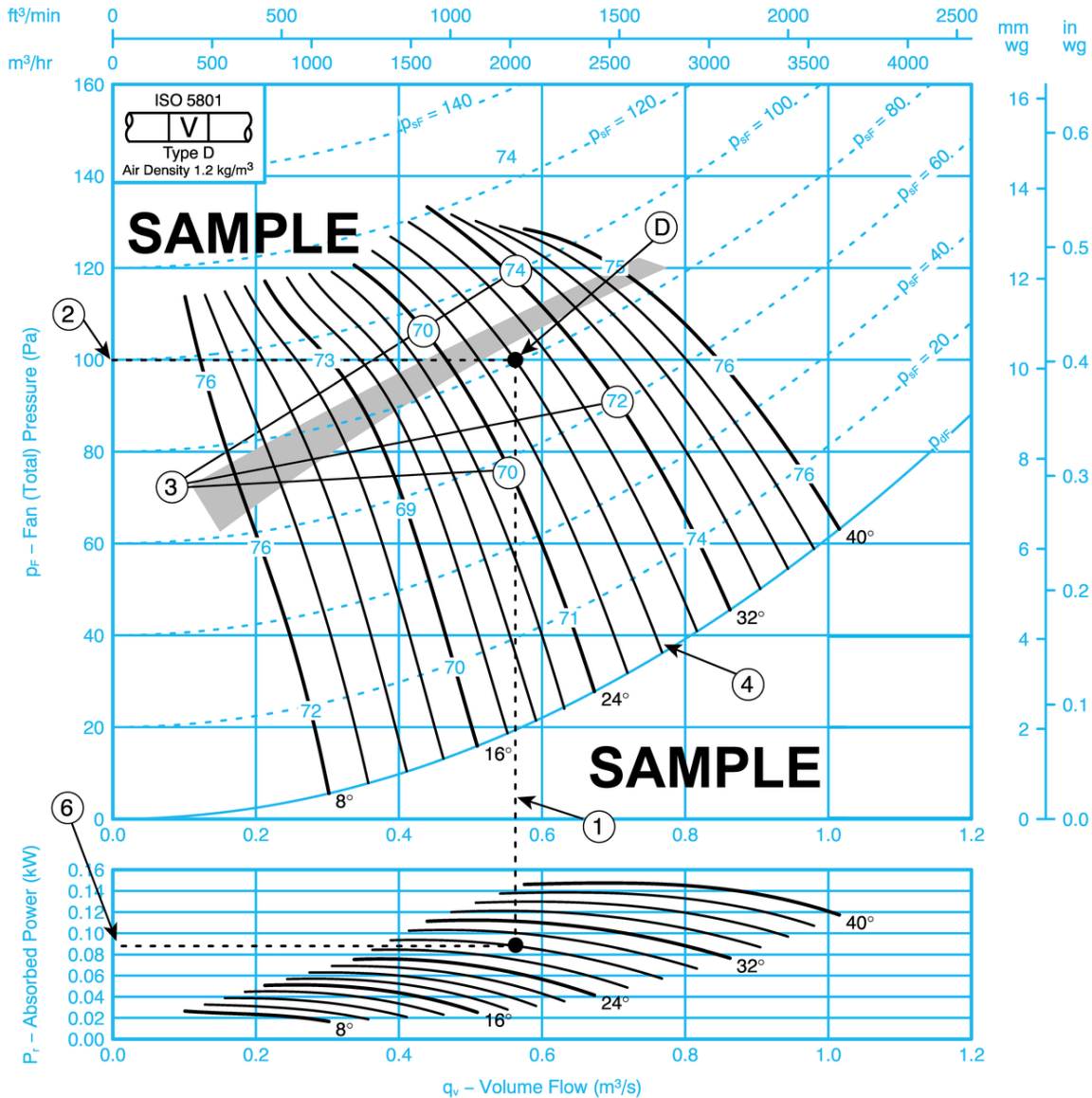

Sound Data ISO 5136

Single figures on performance curves are overall inlet sound power levels, derived from measurements taken in Woods laboratory specifically under ducted conditions. For sound power levels in eight octave bands, apply the following corrections to the overall level. Use upper corrections when operating point is above shaded area, or lower corrections when operating point is below shaded area.

Pitch Angle	Inlet Levels								Pitch Angle	Outlet Levels							
	Octave Band Centre Frequency (Hz)									Octave Band Centre Frequency (Hz)							
	63	125	250	500	1k	2k	4k	8k		63	125	250	500	1k	2k	4k	8k
8	-9	-7	-5	-5	-13	-20	-27	-35	8	-6	-5	-4	-5	-13	-20	-27	-35
	-14	-10	-7	-3	-10	-16	-22	-31		-12	-8	-7	-3	-9	-16	-20	-29
16	-12	-6	-6	-5	-13	-15	-21	-27	16	-10	-3	-6	-5	-12	-14	-21	-27
	-10	-6	-7	-6	-9	-12	-17	-24		-9	-3	-6	-6	-9	-12	-17	-24
24 - 40	-5	-6	-7	-8	-14	-18	-23	-28	24 - 40	-3	-5	-7	-7	-13	-17	-21	-26
	-7	-5	-8	-7	-12	-16	-21	-27		-5	-2	-7	-7	-12	-16	-20	-26

SK11689

STATIC PRESSURE - SELECTION EXAMPLE

There are two principle methods of expressing the pressure requirements, namely, P_F (Total) and P_{SF} (Static) pressure. The two types of pressure are related:

$$P_F = P_{SF} + P_{dF}$$

P_F = Fan Total pressure
 P_{SF} = Fan Static pressure
 P_{dF} = Fan Dynamic pressure

The international convention considers fan performance in terms of total pressure, but there is also established practice relating to the use of static pressure. For this reason Woods' selection charts are laid out on a total pressure major scale and include a secondary grid for static pressure. The facility to display fan performance in terms of static pressure is necessary in order to avoid total pressure fan selections being made based on static pressure system requirements.

The guide selections are made for either total or static pressures of 100Pa. The resulting selections are quite different and highlight the consequences of selecting static pressure from charts that only display performance in terms of total pressure.

PROCEDURE - STATIC PRESSURE (P_{SF})

1. Guide to Chart Numbers of Possible Selections

The charts are arranged in order of fan diameter, starting at 315 mm, up to 1600 mm diameter, and in order of fan speed for each diameter, 3, 5, 6, 9 & 12 bladed fan impellers as available.

NOTE: The chart numbers lead to a variety of fan sizes, impeller configurations and speeds. The fan selected from the alternatives available will depend on the most critical factor for the particular application - Volume Flow and Pressure required, Size, Power Consumption, Sound Level or First Cost.

2. Required Duty

Establish the volume flow and static pressure required of an individual fan at Standard Air (1.2 kg/m³).

3. Selection on Individual Fan Charts

The data provided on each performance chart is specifically for ducted - Type D (ducted) installations for both long or short cased (S-type) fans. Provided that reasonable Type D conditions are maintained in the installation of the fans, no additional factors to volume flow or pressure need be incorporated for a suitable selection to be made.

Plot the duty on the selected fan charts to establish blade angle, sound level and impeller absorbed power.

- D. Duty Point Required - @ Standard Air (1.2kg/m³).
0.55 m³/s @ 100 Pa **static** pressure.
1. Volume Flow = 0.55 m³/s
 2. Fan Static Pressure = 100 Pa
 3. Overall inlet Sound Power Level = 72 L_w
 4. Blade Angle required to achieve Duty Point = 32°
 5. Corrections to overall Sound Power level for 32° Pitch Angle.
(Operating Point is **ABOVE** shaded area):-

Sound Power Level	Frequency Hz							
	63	125	250	500	1K	2K	4K	8K
Inlet	69	68	67	66	60	56	51	46 L _w
Outlet	71	69	67	67	61	57	53	48 L _w

6. Note that the duty impeller absorbed power for the 32° blade angle = 0.11 kW. To select a suitable motor to cover the full extent of the operating characteristic use our Fan Selection software to confirm the fan selection and obtain the optimum motor.

GUIDE TO FAN SELECTION

STATIC PRESSURE - SELECTION EXAMPLE

Performance Data ISO 5801

Performance shown is for installations type D - Ducted inlet, Ducted outlet. Performance ratings do not include the effects of appurtenances.

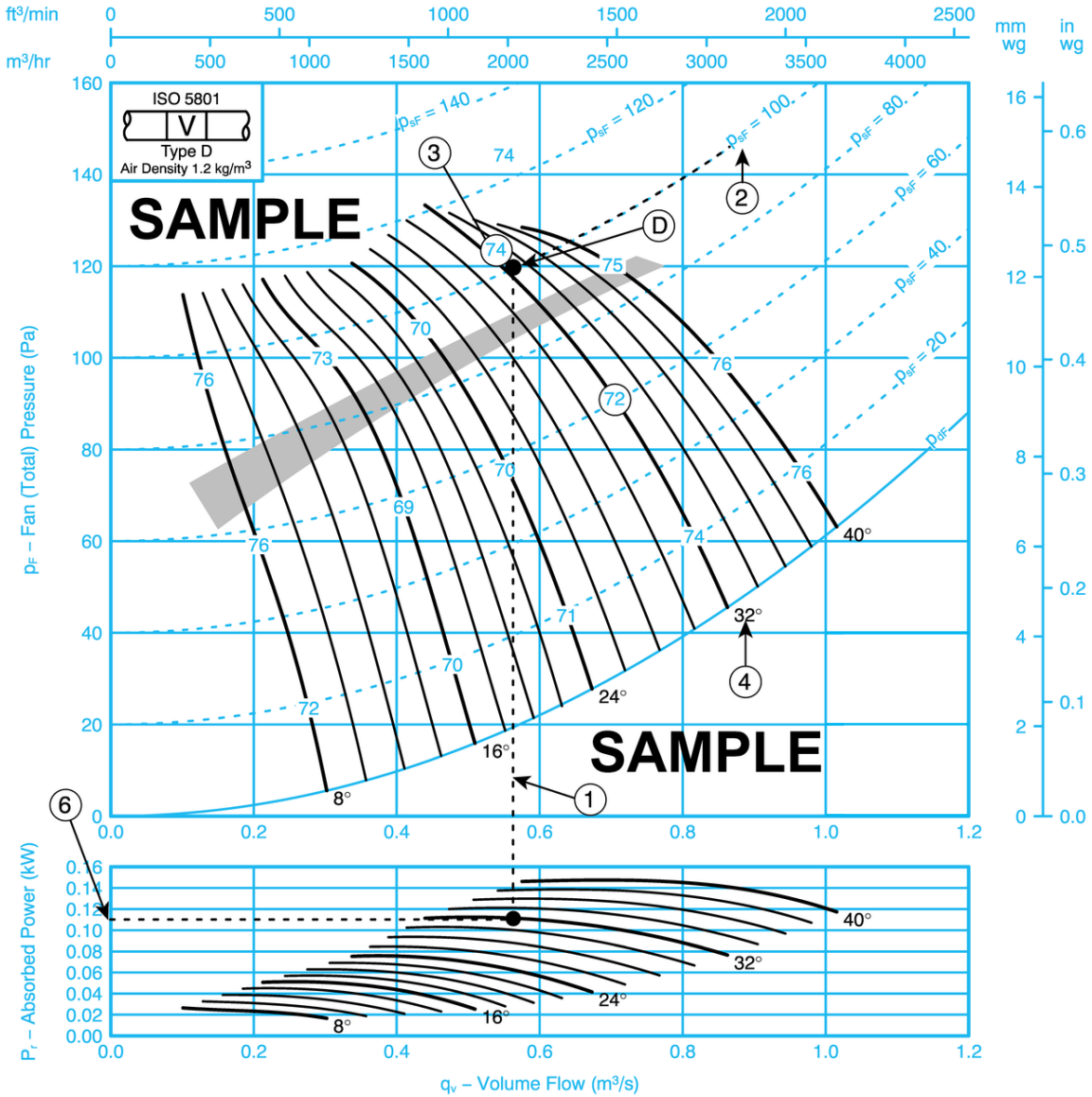

Sound Data ISO 5136

Single figures on performance curves are overall inlet sound power levels, derived from measurements taken in Woods laboratory specifically under ducted conditions. For sound power levels in eight octave bands, apply the following corrections to the overall level. Use upper corrections when operating point is above shaded area, or lower corrections when operating point is below shaded area.

Pitch Angle	Inlet Levels								Outlet Levels								
	Octave Band Centre Frequency (Hz)								Octave Band Centre Frequency (Hz)								
	63	125	250	500	1k	2k	4k	8k	Pitch Angle	63	125	250	500	1k	2k	4k	8k
8	-9	-7	-5	-3	-13	-20	-27	-35	8	-6	-5	-4	-5	-13	-20	-27	-35
	-14	-10	-7	-5	-10	-16	-22	-31		-12	-8	-7	-7	-9	-16	-20	-29
16	-12	-6	-6	-5	-13	-15	-21	-27	16	-10	-3	-6	-5	-12	-14	-21	-27
	-10	-6	-7	-6	-9	-12	-17	-24		-9	-3	-6	-6	-9	-12	-17	-24
24 - 40	-5	-6	-7	-8	-14	-18	-23	-28	24 - 40	-3	-5	-7	-7	-13	-17	-21	-26
	-7	-5	-8	-7	-12	-16	-21	-27		-5	-2	-7	-7	-12	-16	-20	-26

SK11689

FAN CODE: 31JM/16/6/5/...
 315mm 1090 rev/min 5 Blades 60 Hz

Performance Data ISO 5801

Performances shown is for installation type D – Ducted inlet, Ducted outlet. Performance ratings do not include the effects of appurtenances.

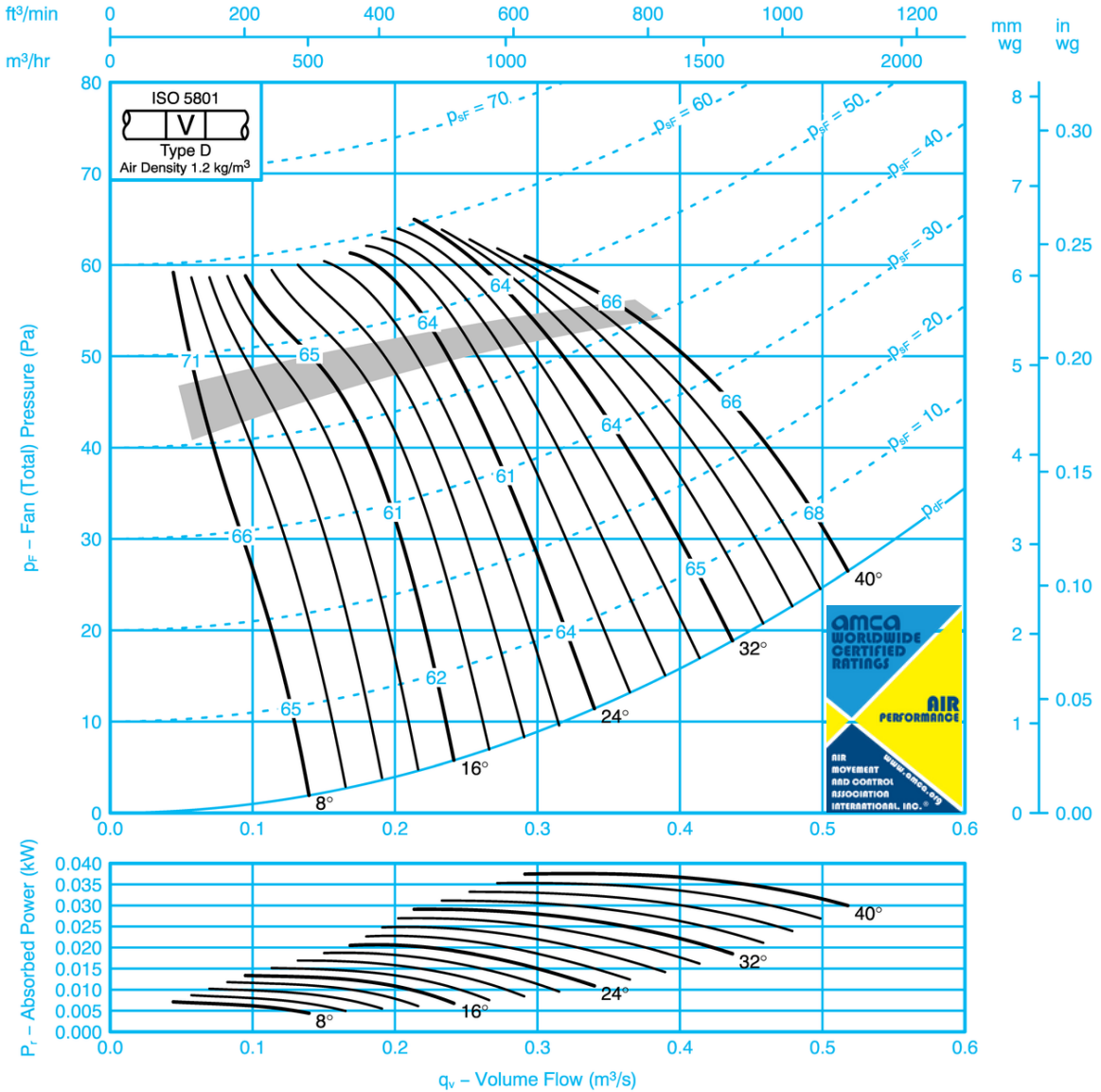

Sound Data ISO 5136

Single figures on performance curves are overall inlet sound power levels, derived from measurements taken in Woods laboratory specifically under ducted conditions. For sound power levels in eight octave bands, apply the following corrections to the overall level. Use upper corrections when operating point is above shaded area, or lower corrections when operating point is below shaded area.

Inlet Levels								Outlet Levels									
Pitch Angle	Octave Band Centre Frequency (Hz)								Pitch Angle	Octave Band Centre Frequency (Hz)							
	63	125	250	500	1k	2k	4k	8k		63	125	250	500	1k	2k	4k	8k
8	-5	-5	-6	-10	-18	-25	-31	-40	8	-2	-3	-6	-10	-18	-24	-31	-40
	-11	-8	-4	-5	-13	-19	-27	-36		-9	-5	-4	-5	-13	-19	-26	-34
16	-8	-4	-6	-9	-15	-22	-29	-36	16	-6	-1	-6	-9	-14	-21	-29	-36
	-7	-5	-6	-8	-12	-16	-22	-27		-5	-3	-6	-8	-12	-15	-22	-27
24-40	-3	-6	-9	-12	-17	-21	-26	-31	24-40	-1	-5	-9	-12	-16	-19	-24	-29
	-5	-5	-8	-10	-14	-18	-24	-30		-2	-2	-8	-10	-14	-18	-23	-29

SK11877

WAM_DC_00073GB_60HZ JM AEROFOIL
 January 2024



FAN CODE: 31JM/16/4/5/...
 315mm 1680 rev/min 5 Blades 60 Hz

Performance Data ISO 5801

Performance shown is for installations type D – Ducted inlet, Ducted outlet. Performance ratings do not include the effects of appurtenances.

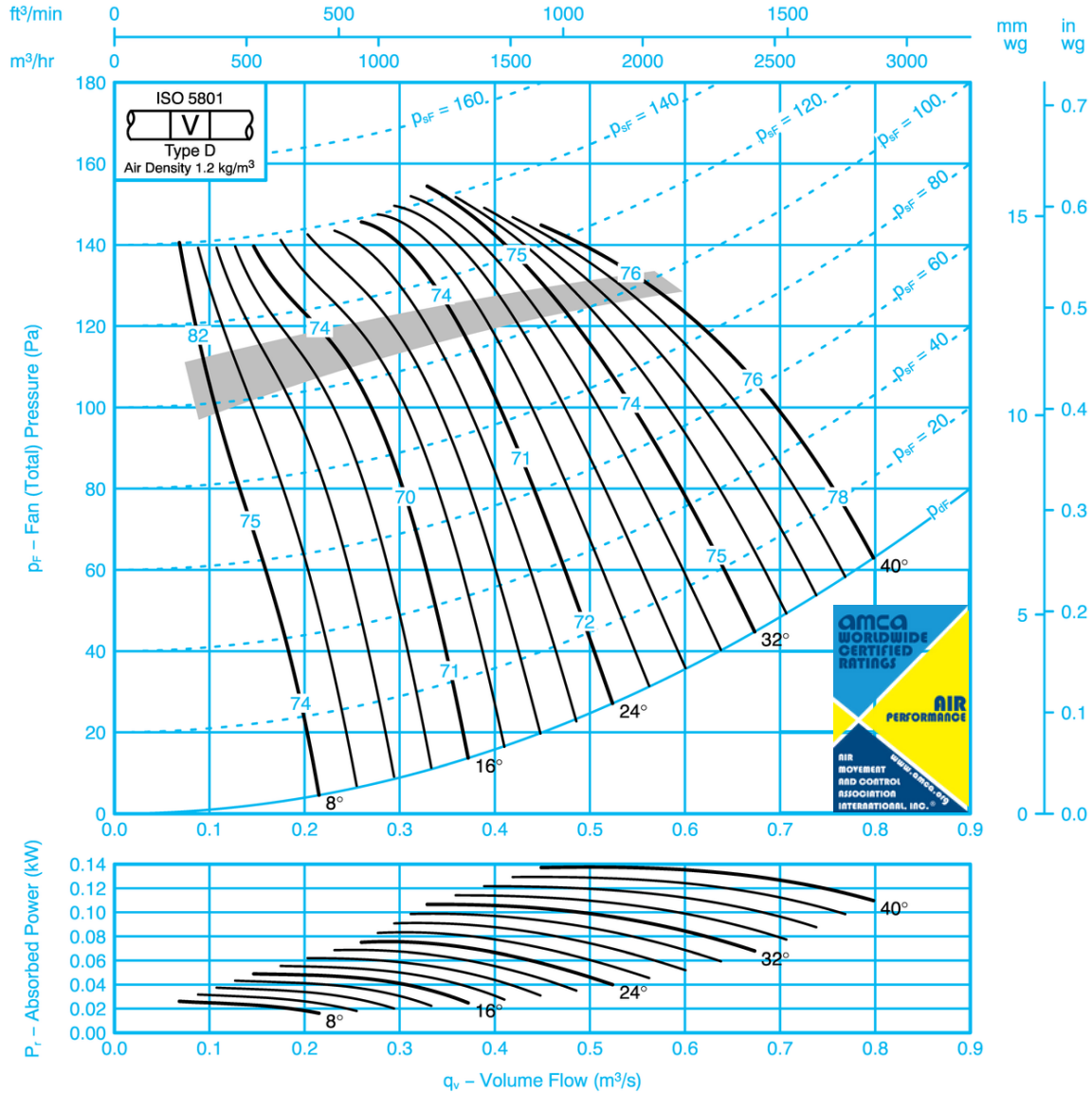

Sound Data ISO 5136

Single figures on performance curves are overall inlet sound power levels, derived from measurements taken in Woods laboratory specifically under ducted conditions. For sound power levels in eight octave bands, apply the following corrections to the overall level. Use upper corrections when operating point is above shaded area, or lower corrections when operating point is below shaded area.

Inlet Levels								Outlet Levels									
Pitch Angle	Octave Band Centre Frequency (Hz)								Pitch Angle	Octave Band Centre Frequency (Hz)							
	63	125	250	500	1k	2k	4k	8k		63	125	250	500	1k	2k	4k	8k
8	-10	-5	-6	-7	-13	-20	-27	-35	8	-7	-2	-5	-7	-13	-19	-27	-35
	-14	-8	-9	-3	-7	-14	-21	-30		-12	-6	-8	-3	-7	-14	-20	-28
16	-13	-5	-6	-6	-12	-17	-24	-32	16	-12	-3	-5	-6	-11	-15	-24	-32
	-13	-5	-7	-6	-9	-13	-18	-24		-11	-2	-7	-6	-9	-12	-18	-24
24-40	-5	-4	-9	-10	-15	-18	-23	-28	24-40	-4	-2	-8	-9	-14	-16	-21	-27
	-8	-4	-8	-9	-12	-15	-20	-27		-6	-1	-7	-9	-12	-15	-19	-26

SK11878

WAM_DC_00073GB_60HZ JM AEROFOIL
 January 2024



FAN CODE: 31JM/16/2/5/...
 315mm 3400 rev/min 5 Blades 60 Hz

Performance Data ISO 5801

Performances shown is for installations type D – Ducted inlet, Ducted outlet. Performance ratings do not include the effects of appurtenances.

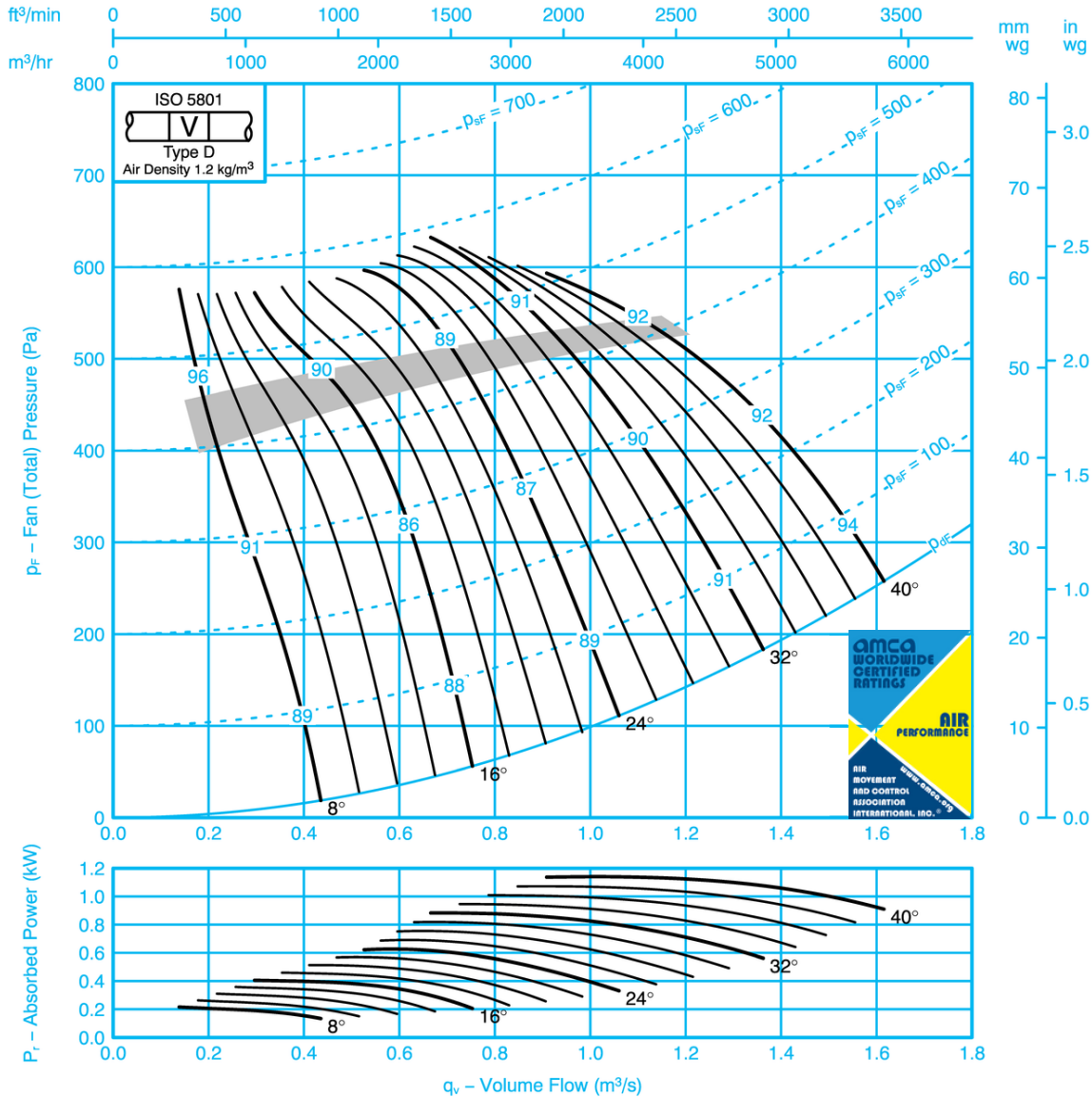

Sound Data ISO 5136

Single figures on performance curves are overall inlet sound power levels, derived from measurements taken in Woods laboratory specifically under ducted conditions. For sound power levels in eight octave bands, apply the following corrections to the overall level. Use upper corrections when operating point is above shaded area, or lower corrections when operating point is below shaded area.

Inlet Levels									Outlet Levels								
Pitch Angle	Octave Band Centre Frequency (Hz)								Pitch Angle	Octave Band Centre Frequency (Hz)							
	63	125	250	500	1k	2k	4k	8k		63	125	250	500	1k	2k	4k	8k
8	-13	-10	-5	-6	-7	-13	-20	-27	8	-11	-9	-3	-4	-7	-12	-21	-27
	-16	-14	-9	-9	-4	-7	-15	-21		-14	-14	-6	-8	-4	-7	-13	-19
16	-15	-13	-5	-6	-6	-12	-17	-25	16	-13	-13	-2	-5	-5	-11	-17	-25
	-15	-13	-5	-7	-6	-10	-13	-18		-13	-13	-2	-6	-6	-9	-13	-18
24-40	-9	-6	-5	-10	-11	-16	-18	-24	24-40	-8	-5	-4	-8	-10	-14	-17	-22
	-9	-9	-4	-9	-9	-13	-16	-21		-7	-8	-2	-7	-9	-12	-15	-20

SK11879

WAM_DC_00073GB_60HZ JM AEROFOIL
 January 2024



FAN CODE: 35JM/16/6/5/...
 355mm 1090 rev/min 5 Blades 60 Hz

Performance Data ISO 5801

Performance shown is for installations type D – Ducted inlet, Ducted outlet. Performance ratings do not include the effects of appurtenances.

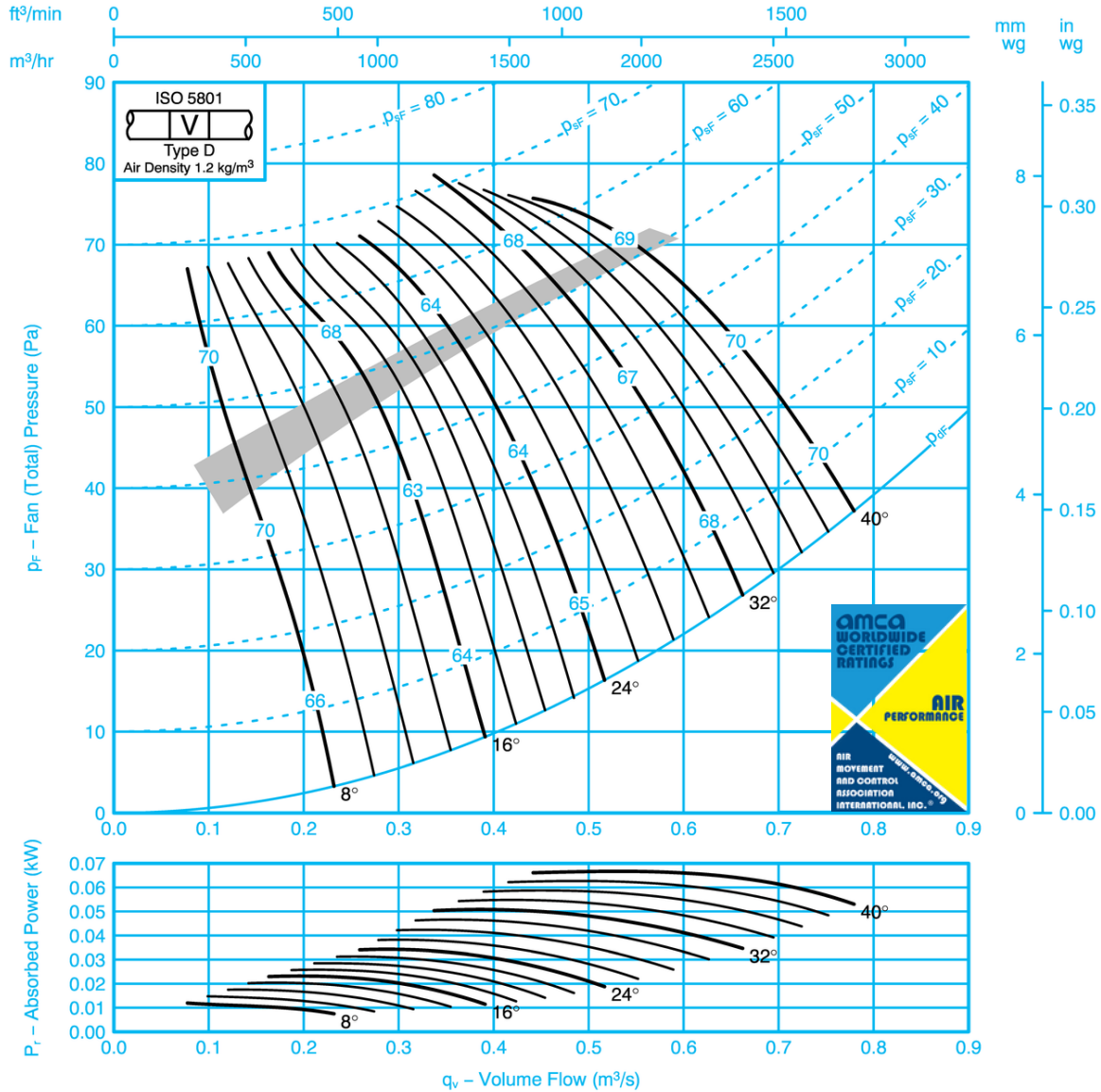

Sound Data ISO 5136

Single figures on performance curves are overall inlet sound power levels, derived from measurements taken in Woods laboratory specifically under ducted conditions. For sound power levels in eight octave bands, apply the following corrections to the overall level. Use upper corrections when operating point is above shaded area, or lower corrections when operating point is below shaded area.

Inlet Levels								Outlet Levels									
Pitch Angle	Octave Band Centre Frequency (Hz)								Pitch Angle	Octave Band Centre Frequency (Hz)							
	63	125	250	500	1k	2k	4k	8k		63	125	250	500	1k	2k	4k	8k
8	-7	-7	-5	-7	-15	-22	-29	-39	8	-4	-5	-4	-7	-15	-21	-29	-38
	-13	-10	-4	-4	-11	-18	-24	-31		-11	-8	-4	-4	-11	-17	-23	-29
16	-9	-6	-4	-8	-13	-17	-23	-28	16	-6	-4	-4	-8	-12	-16	-23	-28
	-8	-7	-6	-7	-10	-13	-18	-22		-6	-5	-6	-7	-9	-13	-18	-22
24-40	-4	-7	-7	-8	-15	-19	-25	-31	24-40	-2	-6	-7	-8	-14	-17	-23	-29
	-6	-6	-6	-8	-13	-17	-22	-27		-3	-3	-6	-8	-13	-17	-21	-26

SK11880

WAM_DC_00073GB_60HZ JM AEROFOIL
 January 2024



FAN CODE: 35JM/16/4/5/...
 355mm 1680 rev/min 5 Blades 60 Hz

Performance Data ISO 5801

Performance shown is for installations type D – Ducted inlet, Ducted outlet. Performance ratings do not include the effects of appurtenances.

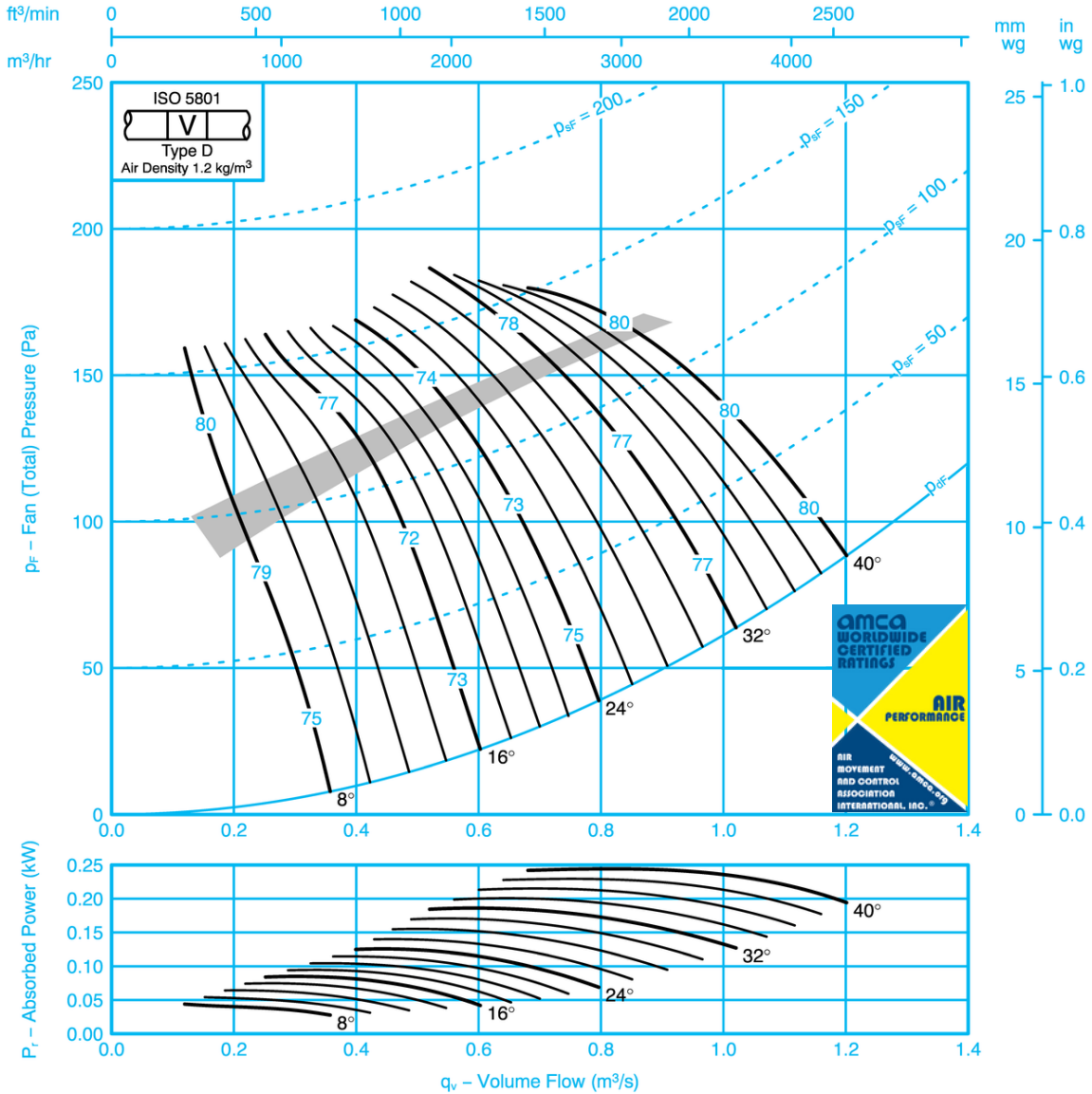

Sound Data ISO 5136

Single figures on performance curves are overall inlet sound power levels, derived from measurements taken in Woods laboratory specifically under ducted conditions. For sound power levels in eight octave bands, apply the following corrections to the overall level. Use upper corrections when operating point is above shaded area, or lower corrections when operating point is below shaded area.

Inlet Levels									Outlet Levels								
Pitch Angle	Octave Band Centre Frequency (Hz)								Pitch Angle	Octave Band Centre Frequency (Hz)							
	63	125	250	500	1k	2k	4k	8k		63	125	250	500	1k	2k	4k	8k
8	-11	-7	-7	-5	-9	-17	-24	-33	8	-9	-4	-6	-5	-9	-16	-24	-33
	-15	-11	-10	-3	-6	-13	-19	-27		-14	-9	-10	-3	-6	-13	-18	-25
16	-13	-6	-7	-4	-11	-13	-19	-25	16	-12	-4	-6	-4	-10	-12	-19	-25
	-12	-7	-8	-6	-8	-11	-15	-20		-10	-4	-8	-6	-8	-10	-15	-20
24-40	-6	-5	-8	-7	-11	-16	-21	-28	24-40	-5	-3	-8	-7	-10	-15	-19	-26
	-8	-5	-8	-7	-11	-14	-19	-25		-6	-2	-7	-7	-11	-14	-18	-24

SK11881

WAM_DC_00073GB_60HZ JM AEROFOIL
 January 2024



FAN CODE: 35JM/16/2/5/...
355mm 3400 rev/min 5 Blades 60 Hz

Performance Data ISO 5801

Performances shown is for installations type D – Ducted inlet, Ducted outlet. Performance ratings do not include the effects of appurtenances.

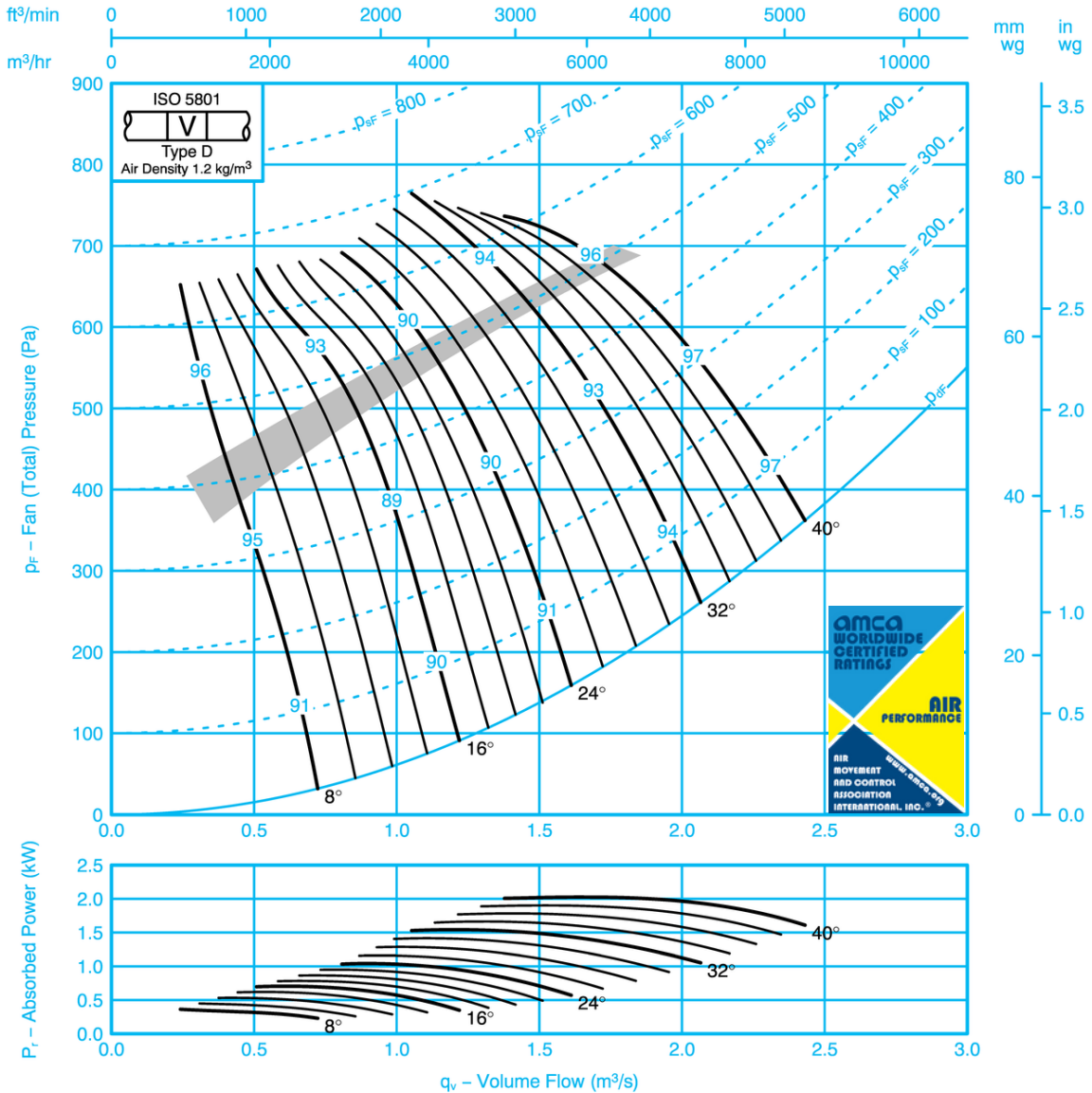

Sound Data ISO 5136

Single figures on performance curves are overall inlet sound power levels, derived from measurements taken in Woods laboratory specifically under ducted conditions. For sound power levels in eight octave bands, apply the following corrections to the overall level. Use upper corrections when operating point is above shaded area, or lower corrections when operating point is below shaded area.

Inlet Levels									Outlet Levels								
Pitch Angle	Octave Band Centre Frequency (Hz)								Pitch Angle	Octave Band Centre Frequency (Hz)							
	63	125	250	500	1k	2k	4k	8k		63	125	250	500	1k	2k	4k	8k
8	-13	-11	-7	-7	-5	-10	-18	-25	8	-10	-11	-5	-6	-5	-8	-18	-24
	-17	-15	-11	-10	-3	-6	-13	-19		-16	-15	-9	-9	-3	-6	-12	-17
16	-10	-14	-7	-7	-5	-11	-14	-19	16	-9	-14	-4	-6	-4	-10	-14	-19
	-10	-12	-7	-8	-6	-9	-11	-15		-8	-12	-4	-7	-6	-8	-11	-15
24-40	-8	-7	-6	-9	-8	-12	-17	-22	24-40	-7	-7	-5	-8	-7	-10	-15	-20
	-7	-9	-6	-9	-8	-12	-15	-20		-5	-8	-3	-7	-7	-12	-14	-18

SK11882

WAM_DC_00073GB_60HZ JM AEROFOIL
January 2024



FAN CODE: 35JM/20/2/6/...
 350mm 3500 rev/min 6 Blades 60 Hz

Performance Data ISO 5801

Performance shown is for installation type C- Ducted inlet, Ducted outlet. Performance ratings do not include the effects of appurtenances.

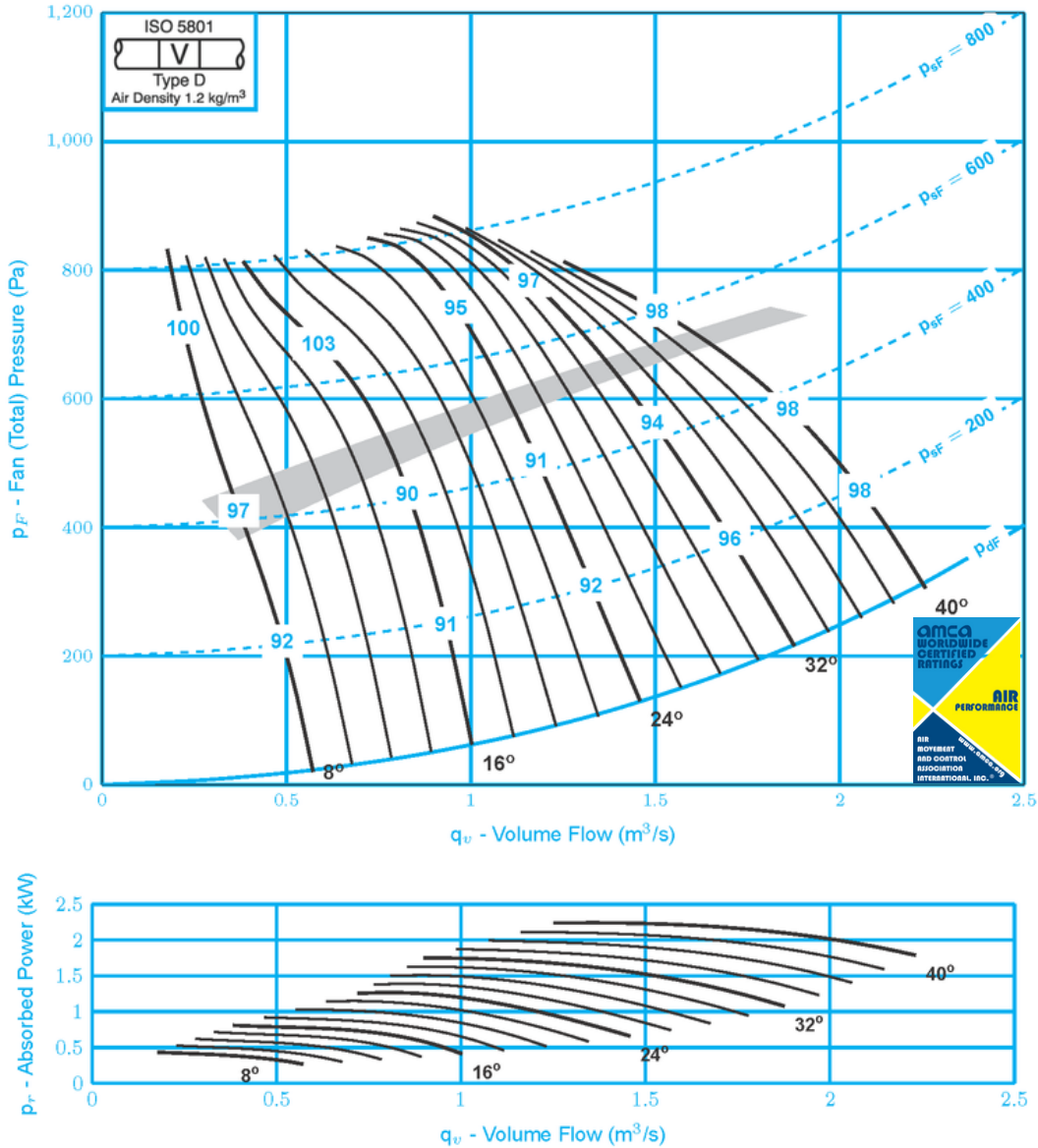

If it is intended to run this fan in reverse for other than emergency operation, please refer to Woods Air Movement.

Sound Data ISO 5136

Single figures on performance curves are overall inlet sound power levels, derived from measurements taken in Woods laboratory specifically under ducted conditions. For sound power levels in eight octave bands, apply the following corrections to the overall level. Use upper corrections when operating point is above shaded area, or lower corrections when operating point is below shaded area.

Inlet Levels									Outlet Levels								
Pitch Angle	Octave Band Center Frequency (Hz)								Pitch Angle	Octave Band Center Frequency (Hz)							
	63	125	250	500	1k	2k	4k	8k		63	125	250	500	1k	2k	4k	8k
8°	-13	-11	-6	-6	-5	-12	-20	-26	8°	-10	-10	-4	-5	-5	-11	-20	-26
	-17	-15	-10	-8	-3	-8	-15	-21		-15	-15	-8	-7	-3	-8	-14	-18
16°	-10	-13	-6	-7	-5	-13	-15	-21	16°	-9	-13	-3	-6	-4	-12	-15	-21
	-10	-12	-6	-8	-7	-10	-13	-16		-8	-12	-3	-7	-6	-9	-13	-16
24-40°	-8	-6	-6	-9	-9	-14	-18	-23	24-40°	-7	-6	-5	-7	-8	-12	-16	-21
	-7	-9	-5	-9	-8	-13	-16	-21		-5	-8	-3	-8	-8	-13	-15	-20



FAN CODE: 40JM/16/6/5/...
 400mm 1090 rev/min 5 Blades 60 Hz

Performance Data ISO 5801

Performances shown is for installations type D – Ducted inlet, Ducted outlet. Performance ratings do not include the effects of appurtenances.

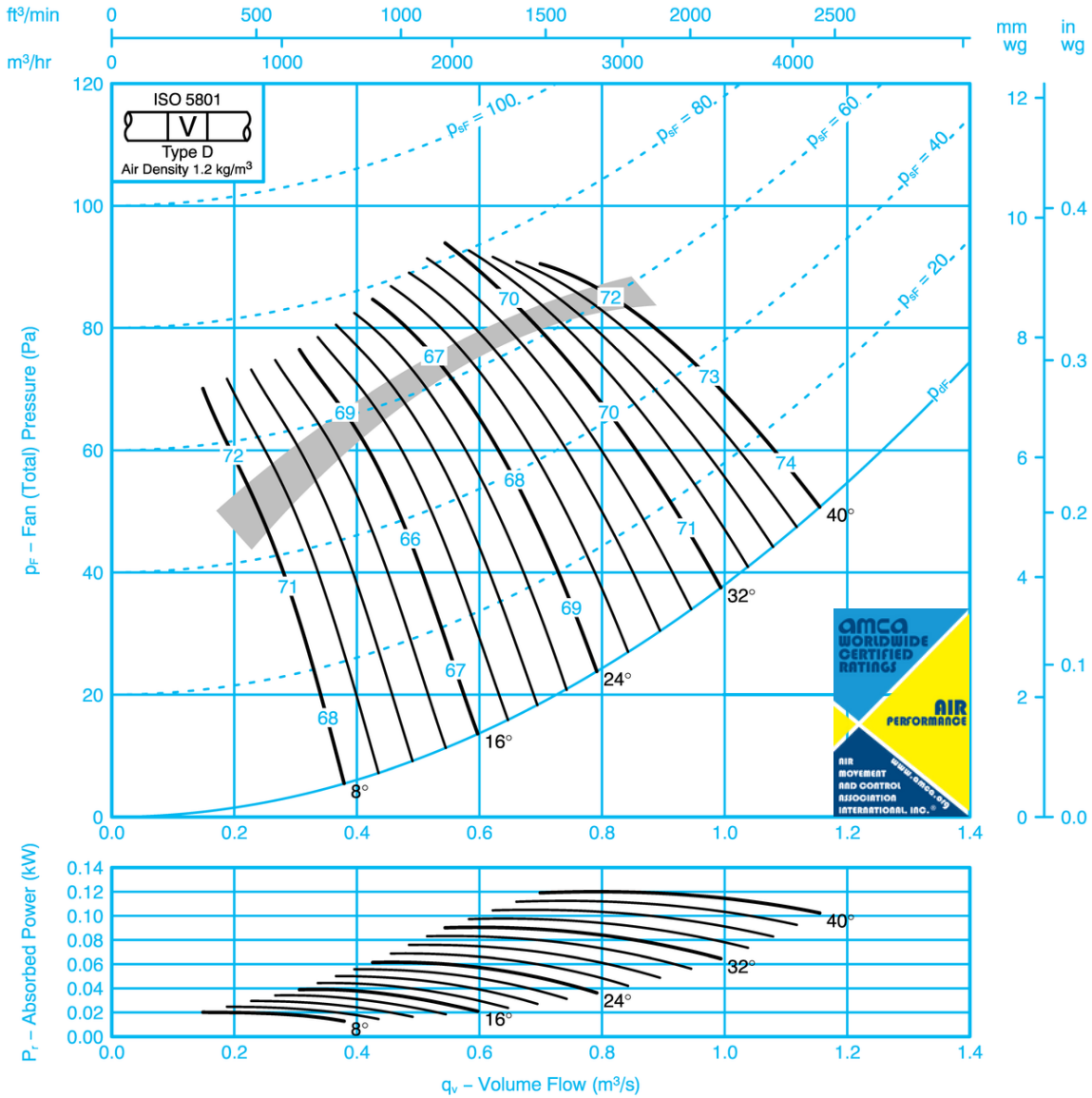

Sound Data ISO 5136

Single figures on performance curves are overall inlet sound power levels, derived from measurements taken in Woods laboratory specifically under ducted conditions. For sound power levels in eight octave bands, apply the following corrections to the overall level. Use upper corrections when operating point is above shaded area, or lower corrections when operating point is below shaded area.

Inlet Levels								Outlet Levels									
Pitch Angle	Octave Band Centre Frequency (Hz)								Pitch Angle	Octave Band Centre Frequency (Hz)							
	63	125	250	500	1k	2k	4k	8k		63	125	250	500	1k	2k	4k	8k
8	-8	-7	-5	-6	-13	-20	-27	-36	8	-5	-5	-5	-6	-13	-19	-27	-36
	-13	-8	-6	-4	-9	-14	-20	-27		-10	-6	-6	-4	-9	-14	-19	-25
16	-8	-5	-7	-7	-11	-15	-22	-27	16	-5	-3	-7	-7	-10	-14	-22	-27
	-8	-5	-7	-8	-10	-13	-17	-20		-6	-2	-7	-8	-10	-12	-17	-20
24-40	-4	-7	-8	-9	-14	-17	-22	-27	24-40	-2	-6	-8	-9	-13	-15	-20	-25
	-5	-6	-8	-9	-13	-16	-21	-26		-2	-3	-8	-9	-13	-16	-20	-25

SK11884

WAM_DC_00073GB_60HZ JM AEROFOIL
 January 2024



Performance Data ISO 5801

Performances shown is for installation type D – Ducted inlet, Ducted outlet. Performance ratings do not include the effects of appurtenances.

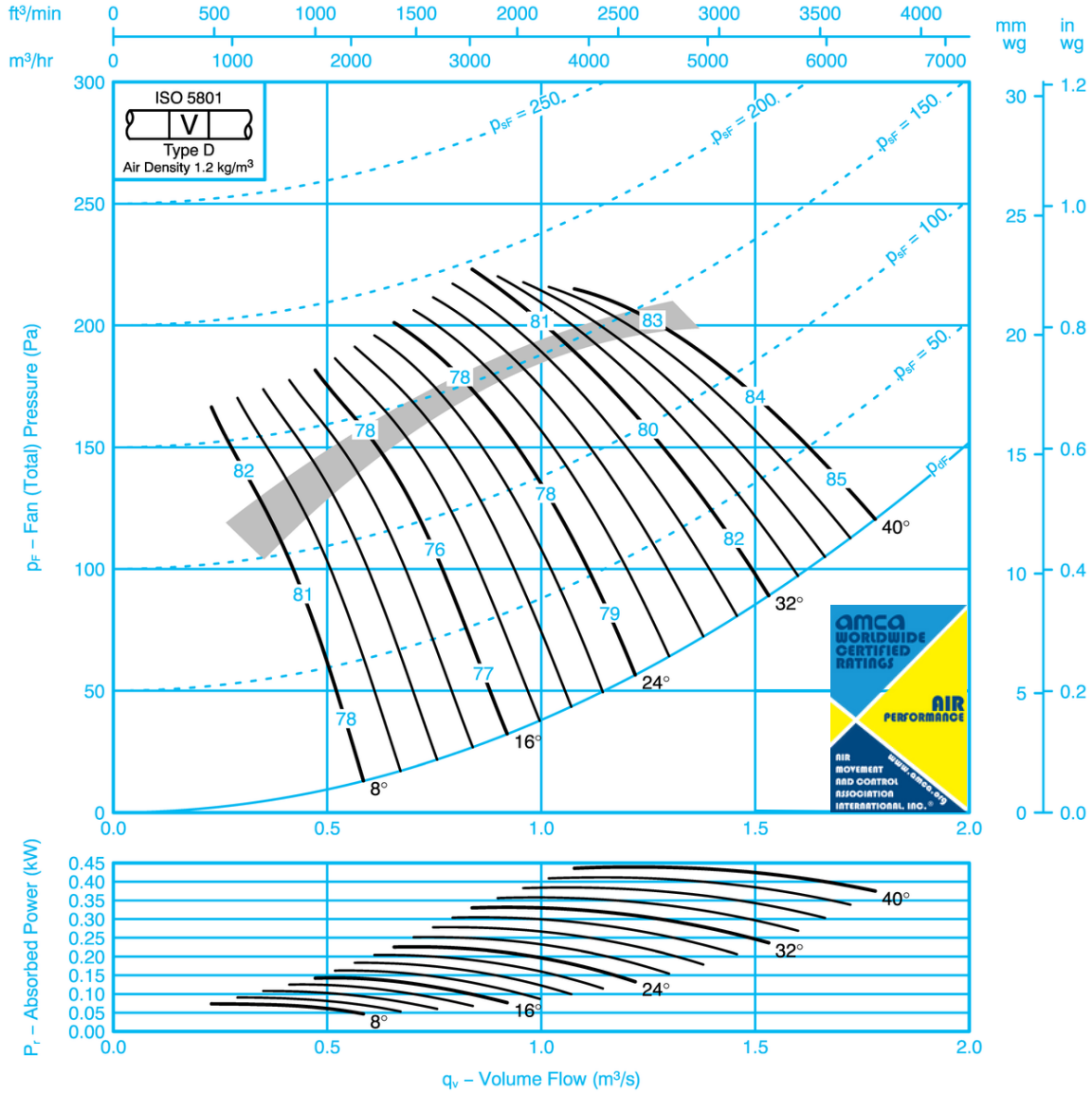

Sound Data ISO 5136

Single figures on performance curves are overall inlet sound power levels, derived from measurements taken in Woods laboratory specifically under ducted conditions. For sound power levels in eight octave bands, apply the following corrections to the overall level. Use upper corrections when operating point is above shaded area, or lower corrections when operating point is below shaded area.

Inlet Levels								Outlet Levels									
Pitch Angle	Octave Band Centre Frequency (Hz)								Pitch Angle	Octave Band Centre Frequency (Hz)							
	63	125	250	500	1k	2k	4k	8k		63	125	250	500	1k	2k	4k	8k
8	-11	-7	-7	-5	-8	-15	-22	-31	8	-9	-5	-7	-5	-8	-14	-22	-30
	-14	-9	-9	-5	-5	-11	-16	-23		-13	-7	-9	-5	-5	-11	-15	-21
16	-12	-5	-6	-7	-9	-12	-17	-24	16	-10	-3	-6	-7	-8	-11	-17	-24
	-11	-5	-8	-8	-9	-11	-14	-19		-10	-3	-7	-8	-9	-10	-14	-19
24-40	-5	-5	-9	-9	-12	-15	-19	-25	24-40	-4	-3	-8	-9	-11	-14	-17	-23
	-7	-5	-8	-8	-11	-14	-18	-24		-5	-2	-7	-8	-11	-14	-17	-23

SK11885

WAM_DC_00073GB_60HZ JM AEROFOIL
January 2024



FAN CODE: 40JM/16/2/5/...
 400mm 3400 rev/min 5 Blades 60 Hz

Performance Data ISO 5801

Performances shown is for installation type D – Ducted inlet, Ducted outlet. Performance ratings do not include the effects of appurtenances.

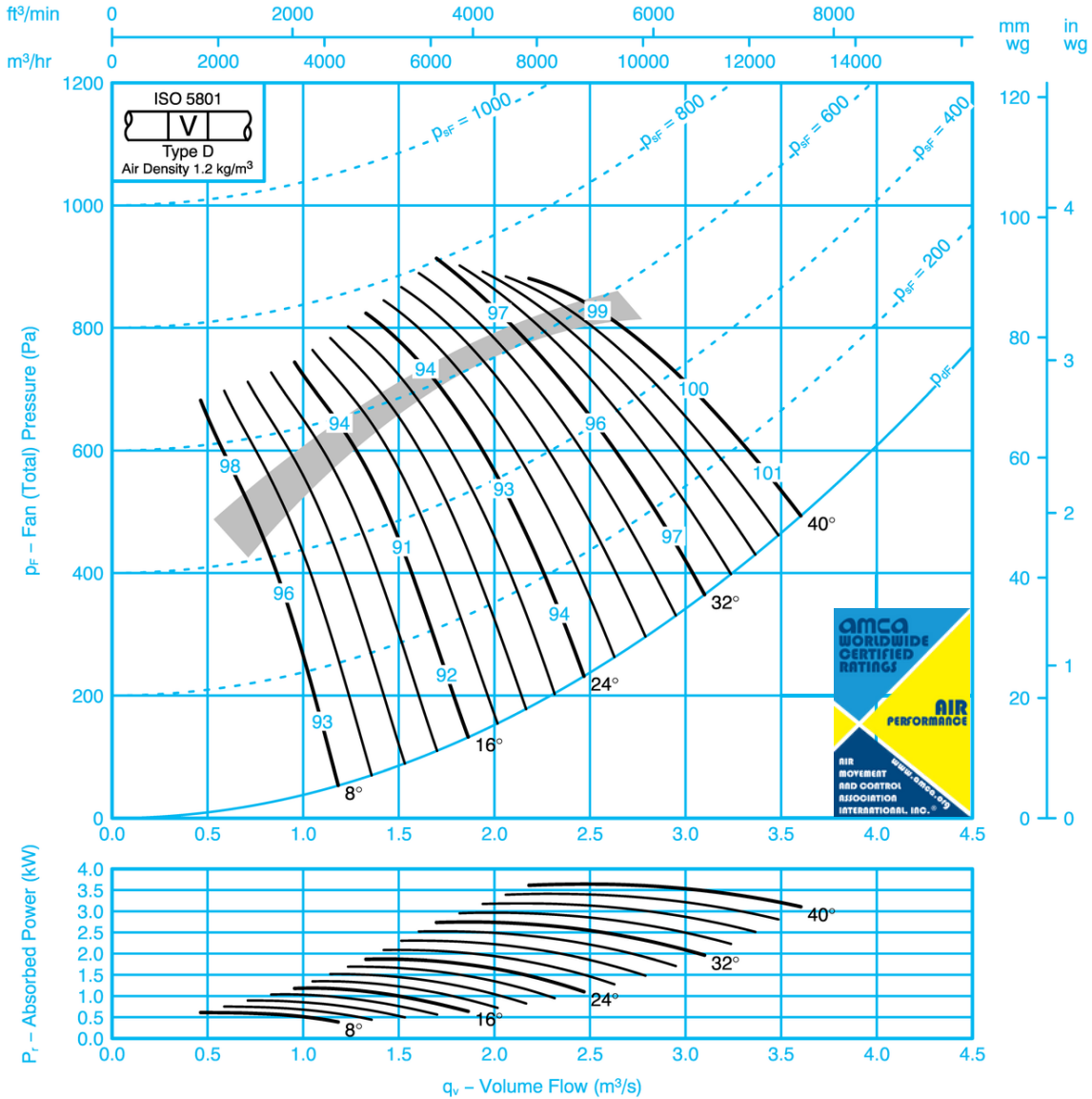

Sound Data ISO 5136

Single figures on performance curves are overall inlet sound power levels, derived from measurements taken in Woods laboratory specifically under ducted conditions. For sound power levels in eight octave bands, apply the following corrections to the overall level. Use upper corrections when operating point is above shaded area, or lower corrections when operating point is below shaded area.

Inlet Levels									Outlet Levels								
Pitch Angle	Octave Band Centre Frequency (Hz)								Pitch Angle	Octave Band Centre Frequency (Hz)							
	63	125	250	500	1k	2k	4k	8k		63	125	250	500	1k	2k	4k	8k
8	-15	-12	-7	-8	-5	-8	-15	-23	8	-12	-11	-5	-6	-5	-7	-15	-22
	-17	-15	-10	-10	-6	-6	-11	-17		-15	-14	-7	-8	-5	-5	-10	-14
16	-12	-12	-6	-7	-8	-10	-13	-18	16	-10	-12	-3	-6	-7	-8	-12	-18
	-12	-12	-6	-8	-8	-10	-12	-15		-10	-11	-3	-7	-8	-9	-11	-14
24-40	-8	-6	-6	-10	-10	-13	-16	-20	24-40	-7	-6	-4	-8	-9	-11	-14	-18
	-9	-8	-6	-9	-10	-12	-15	-19		-6	-7	-3	-7	-9	-12	-14	-17

SK11886

WAM_DC_00073GB_60HZ JM AEROFOIL
 January 2024



FAN CODE: 40JM/20/2/6/...
400mm 3500 rev/min 6 Blades 60 Hz

Performance Data ISO 5801

Performance shown is for installation type C- Ducted inlet, Ducted outlet. Performance ratings do not include the effects of appurtenances.

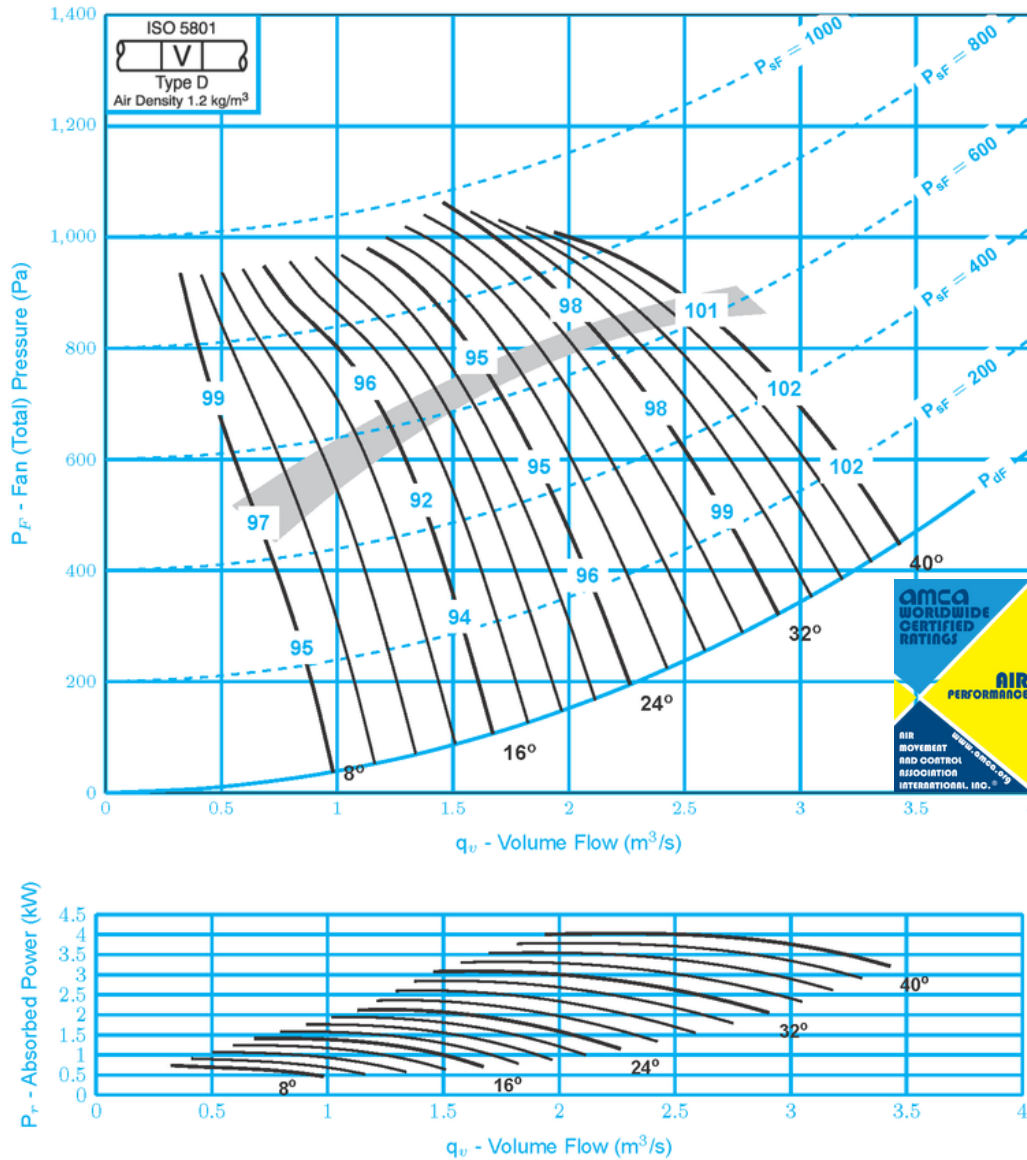

If it is intended to run this fan in reverse for other than emergency operation, please refer to Woods Air Movement.

Sound Data ISO 5136

Single figures on performance curves are overall inlet sound power levels, derived from measurements taken in Woods laboratory specifically under ducted conditions. For sound power levels in eight octave bands, apply the following corrections to the overall level. Use upper corrections when operating point is above shaded area, or lower corrections when operating point is below shaded area.

Inlet Levels									Outlet Levels								
Pitch Angle	Octave Band Center Frequency (Hz)								Pitch Angle	Octave Band Center Frequency (Hz)							
	63	125	250	500	1k	2k	4k	8k		63	125	250	500	1k	2k	4k	8k
8°	-14	-11	-7	-8	-5	-10	-17	-25	8°	-11	-10	-4	-6	-5	-9	-17	-24
	-17	-14	-9	-9	-5	-7	-13	-18		-14	-14	-6	-8	-5	-6	-11	-15
16°	-12	-12	-5	-8	-8	-11	-14	-19	16°	-10	-11	-2	-6	-7	-10	-13	-19
	-12	-12	-5	-8	-9	-10	-12	-16		-10	-11	-2	-7	-8	-9	-12	-15
24-40°	-9	-6	-6	-9	-11	-14	-17	-21	24-40°	-7	-5	-4	-8	-10	-12	-15	-18
	-9	-8	-5	-9	-10	-13	-16	-19		-6	-7	-2	-8	-10	-12	-15	18

SK10630

WAM_DC_00073GB_60HZ JM AEROFOIL
January 2024



FAN CODE: 45JM/16/6/5/...
450mm 1090 rev/min 5 Blades 60 Hz

Performance Data ISO 5801

Performance shown is for installations type D – Ducted inlet, Ducted outlet. Performance ratings do not include the effects of appurtenances.

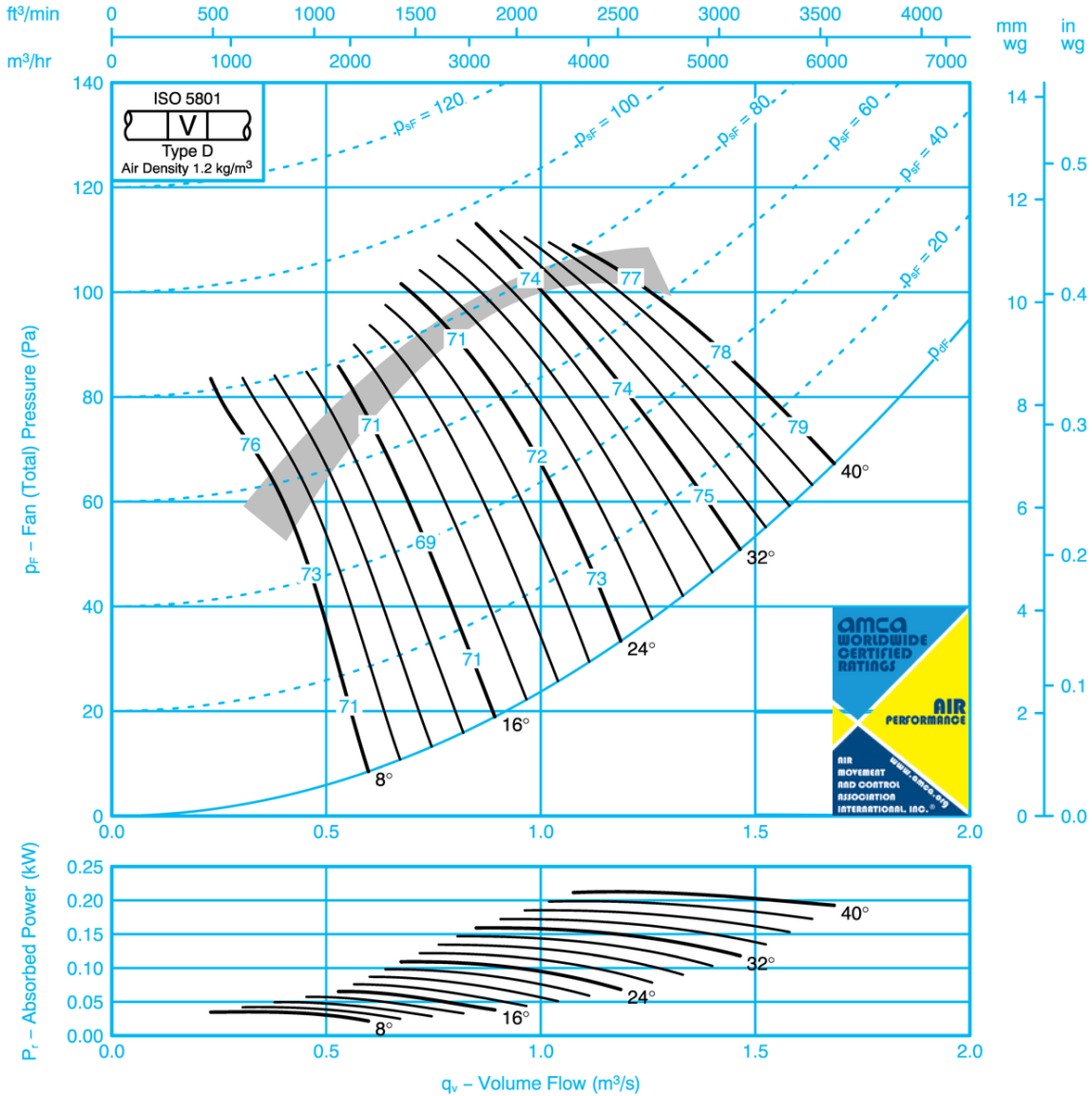

Sound Data ISO 5136

Single figures on performance curves are overall inlet sound power levels, derived from measurements taken in Woods laboratory specifically under ducted conditions. For sound power levels in eight octave bands, apply the following corrections to the overall level. Use upper corrections when operating point is above shaded area, or lower corrections when operating point is below shaded area.

Inlet Levels									Outlet Levels								
Pitch Angle	Octave Band Centre Frequency (Hz)								Pitch Angle	Octave Band Centre Frequency (Hz)							
	63	125	250	500	1k	2k	4k	8k		63	125	250	500	1k	2k	4k	8k
8	-10	-6	-7	-5	-11	-18	-26	-35	8	-9	-4	-7	-5	-11	-18	-25	-32
	-13	-7	-8	-5	-8	-12	-18	-24		-13	-6	-8	-5	-8	-11	-18	-22
16	-8	-4	-10	-7	-10	-14	-22	-28	16	-7	-4	-10	-7	-10	-14	-21	-26
	-9	-3	-9	-10	-11	-13	-17	-20		-9	-3	-9	-10	-11	-12	-16	-18
24-40	-3	-7	-10	-10	-13	-15	-20	-25	24-40	-2	-6	-10	-10	-13	-15	-20	-23
	-5	-5	-9	-10	-13	-15	-21	-25		-4	-5	-9	-10	-13	-15	-20	-23

SK11889

WAM_DC_00073GB_60HZ JM AEROFOIL
January 2024



FAN CODE: 45JM/20/6/3/...
450mm 1090 rev/min 3 Blades 60 Hz

Performance Data ISO 5801

Performance shown is for installations type D – Ducted inlet, Ducted outlet. Performance ratings do not include the effects of appurtenances.

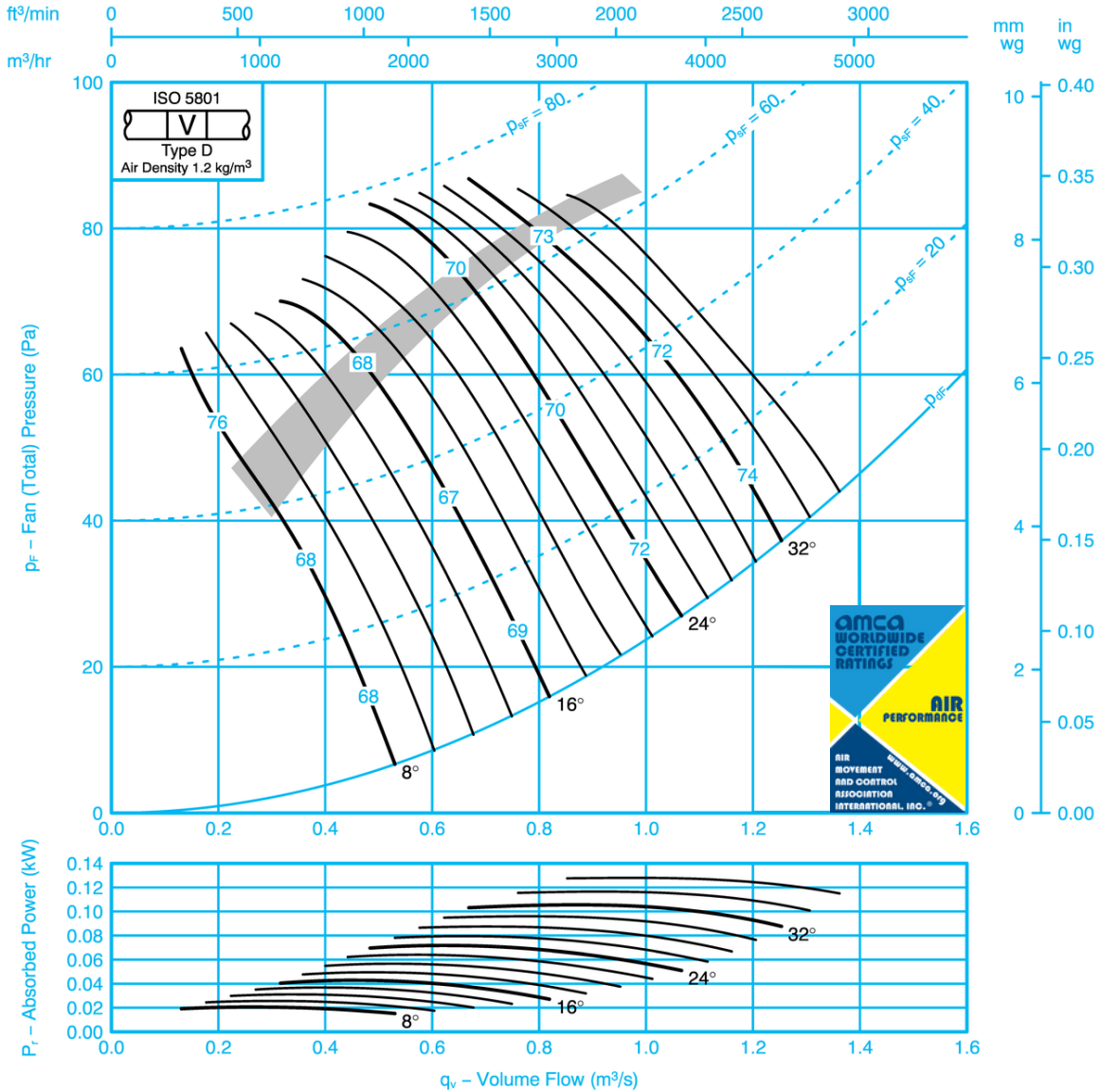

Sound Data ISO 5136

Single figures on performance curves are overall inlet sound power levels, derived from measurements taken in Woods laboratory specifically under ducted conditions. For sound power levels in eight octave bands, apply the following corrections to the overall level. Use upper corrections when operating point is above shaded area, or lower corrections when operating point is below shaded area.

Inlet Levels									Outlet Levels								
Pitch Angle	Octave Band Centre Frequency (Hz)								Pitch Angle	Octave Band Centre Frequency (Hz)							
	63	125	250	500	1k	2k	4k	8k		63	125	250	500	1k	2k	4k	8k
8	-16	-13	-4	-3	-10	-20	-28	-38	8	-13	-13	-4	-3	-10	-19	-27	-36
	-10	-10	-5	-6	-8	-13	-16	-21		-8	-10	-5	-6	-8	-12	-14	-18
16	-8	-6	-4	-8	-12	-16	-21	-27	16	-6	-6	-4	-8	-12	-16	-20	-26
	-6	-8	-6	-8	-10	-15	-18	-23		-4	-8	-6	-8	-10	-15	-18	-22
24-36	-4	-6	-7	-10	-12	-16	-20	-24	24-36	-3	-6	-7	-10	-12	-15	-18	-21
	-4	-8	-6	-10	-12	-16	-21	-25		-2	-8	-6	-10	-12	-16	-20	-23

SK11890

WAM_DC_00073GB_60HZ JM AEROFOIL
January 2024



JM AEROFOIL

FAN CODE: 45JM/20/6/6/...
450mm 1090 rev/min 6 Blades 60 Hz



Performance Data ISO 5801

Performance shown is for installation type D – Ducted inlet, Ducted outlet. Performance ratings do not include the effects of appurtenances.

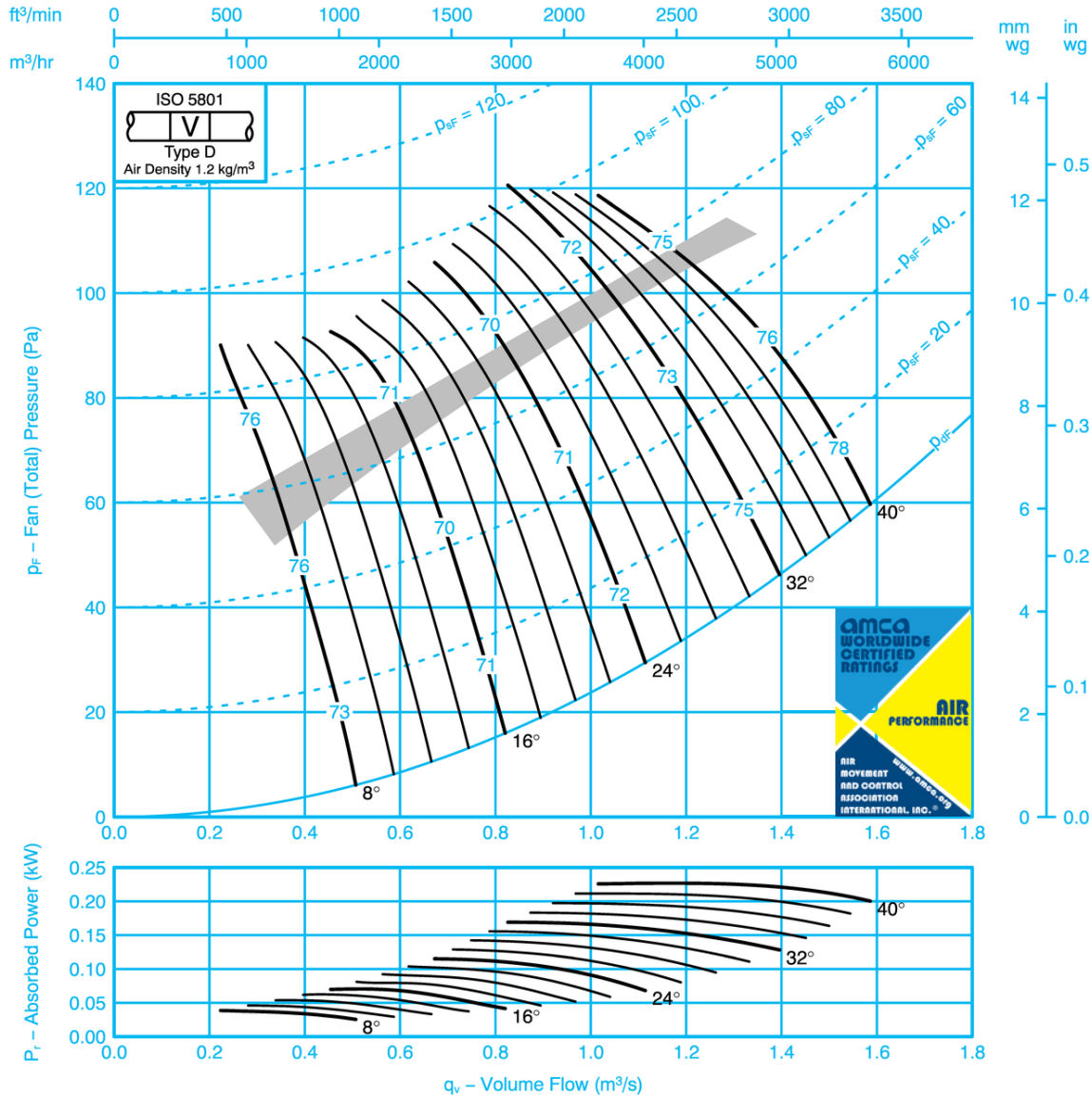

Sound Data ISO 5136

Single figures on performance curves are overall inlet sound power levels, derived from measurements taken in Woods laboratory specifically under ducted conditions. For sound power levels in eight octave bands, apply the following corrections to the overall level. Use upper corrections when operating point is above shaded area, or lower corrections when operating point is below shaded area.

Inlet Levels								Outlet Levels									
Pitch Angle	Octave Band Centre Frequency (Hz)							Pitch Angle	Octave Band Centre Frequency (Hz)								
	63	125	250	500	1k	2k	4k		8k	63	125	250	500	1k	2k	4k	8k
8	-15	-12	-5	-4	-10	-19	-27	-37	8	-13	-10	-5	-4	-9	-13	-27	-36
	-17	-12	-6	-4	-7	-14	-19	-25		-16	-10	-6	-4	-7	-13	-18	-24
16	-12	-6	-4	-8	-9	-14	-19	-24	16	-11	-5	-4	-8	-9	-13	-19	-23
	-14	-7	-5	-7	-9	-12	-15	-18		-12	-5	-5	-7	-9	-12	-15	-17
24-40	-6	-6	-6	-9	-11	-15	-20	-24	24-40	-5	-5	-6	-9	-11	-14	-18	-23
	-8	-6	-6	-8	-10	-15	-18	-21		-6	-4	-6	-8	-10	-14	-17	-20

SK11891

WAM_DC_00073GB_60HZ JM AEROFOIL
January 2024



FAN CODE: 45JM/16/4/5/...
450mm 1680 rev/min 5 Blades 60 Hz

Performance Data ISO 5801

Performances shown is for installations type D – Ducted inlet, Ducted outlet. Performance ratings do not include the effects of appurtenances.

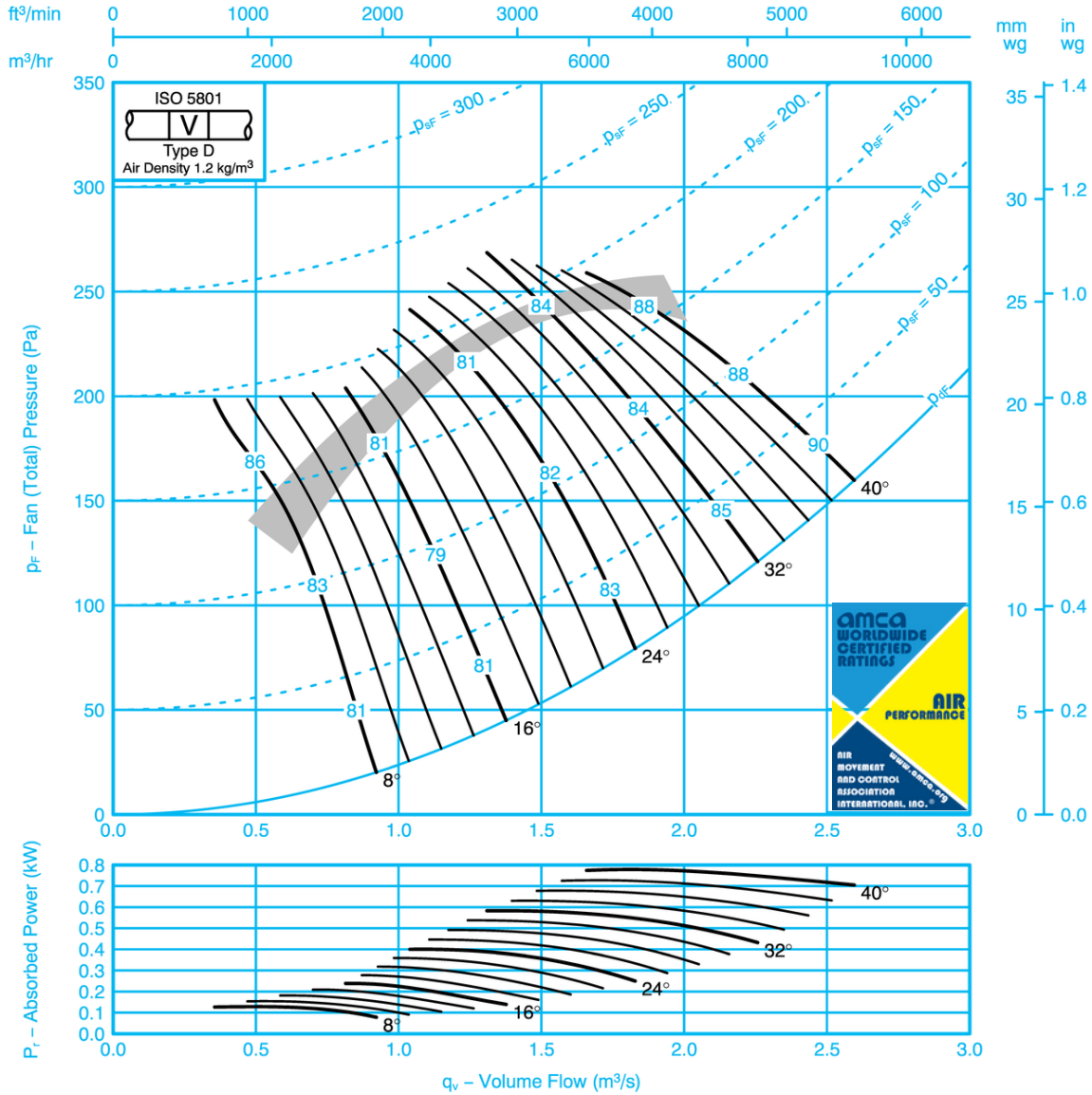

Sound Data ISO 5136

Single figures on performance curves are overall inlet sound power levels, derived from measurements taken in Woods laboratory specifically under ducted conditions. For sound power levels in eight octave bands, apply the following corrections to the overall level. Use upper corrections when operating point is above shaded area, or lower corrections when operating point is below shaded area.

Inlet Levels									Outlet Levels								
Pitch Angle	Octave Band Centre Frequency (Hz)								Pitch Angle	Octave Band Centre Frequency (Hz)							
	63	125	250	500	1k	2k	4k	8k		63	125	250	500	1k	2k	4k	8k
8	-12	-7	-8	-5	-7	-12	-20	-30	8	-12	-5	-8	-5	-7	-12	-20	-28
	-14	-8	-9	-8	-5	-9	-14	-21		-14	-7	-9	-8	-5	-8	-13	-19
16	-10	-5	-7	-10	-8	-11	-16	-25	16	-9	-5	-7	-10	-8	-11	-16	-23
	-11	-3	-8	-11	-11	-12	-14	-19		-11	-3	-8	-10	-11	-11	-13	-17
24-40	-4	-5	-9	-12	-12	-15	-17	-23	24-40	-4	-5	-9	-12	-12	-15	-17	-22
	-6	-5	-8	-11	-12	-14	-17	-24		-5	-4	-8	-11	-12	-14	-16	-22

SK11892

WAM_DC_00073GB_60HZ JM AEROFOIL
January 2024



FAN CODE: 45JM/20/4/3/...
 450mm 1680 rev/min 3 Blades 60 Hz

Performance Data ISO 5801

Performances shown is for installations type D – Ducted inlet, Ducted outlet. Performance ratings do not include the effects of appurtenances.

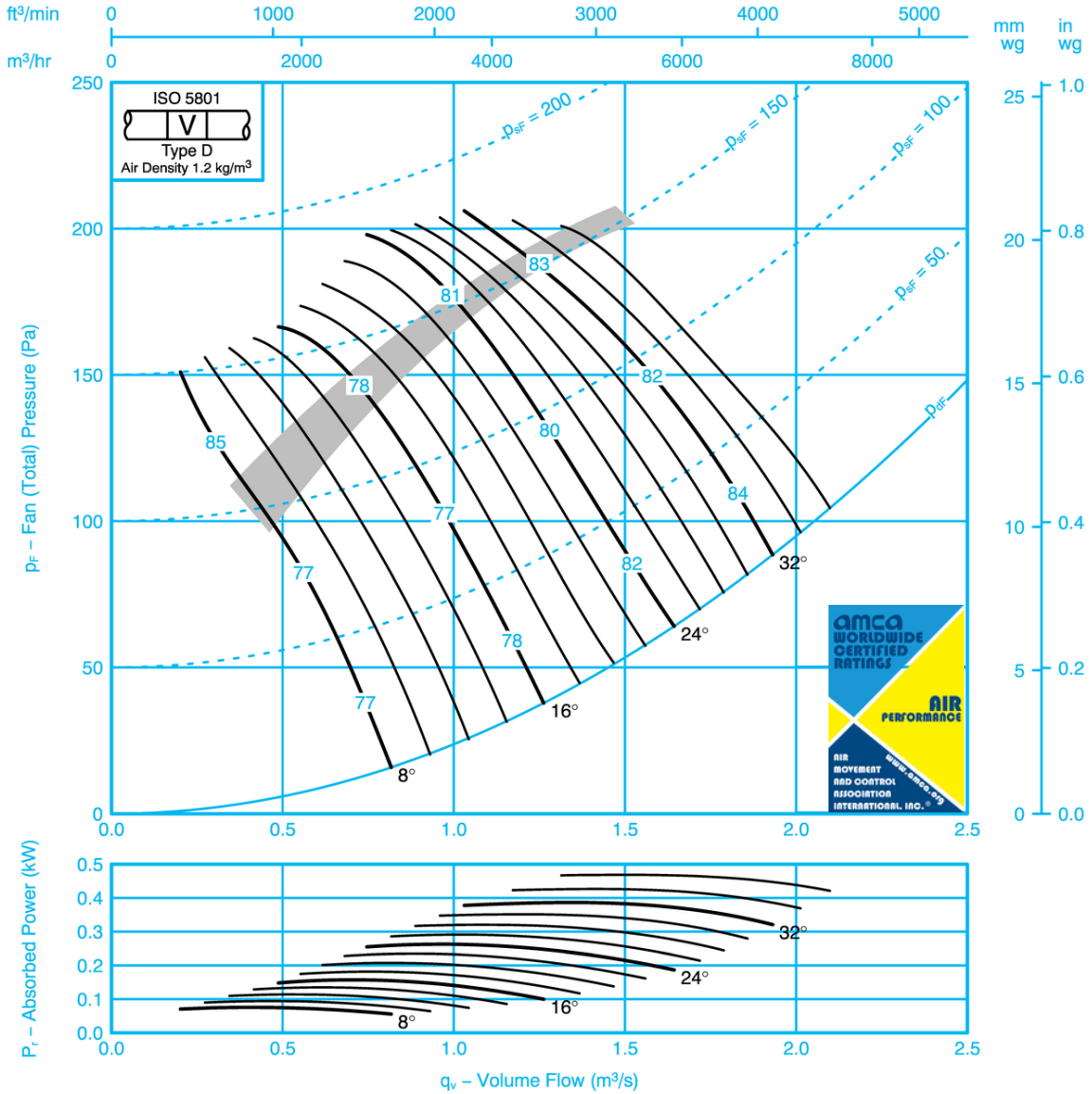

Sound Data ISO 5136

Single figures on performance curves are overall inlet sound power levels, derived from measurements taken in Woods laboratory specifically under ducted conditions. For sound power levels in eight octave bands, apply the following corrections to the overall level. Use upper corrections when operating point is above shaded area, or lower corrections when operating point is below shaded area.

Inlet Levels									Outlet Levels								
Pitch Angle	Octave Band Centre Frequency (Hz)								Pitch Angle	Octave Band Centre Frequency (Hz)							
	63	125	250	500	1k	2k	4k	8k		63	125	250	500	1k	2k	4k	8k
8	-19	-16	-11	-3	-5	-12	-22	-32	8	-17	-14	-11	-3	-5	-12	-21	-30
	-15	-11	-9	-5	-6	-10	-14	-18		-13	-9	-8	-5	-6	-9	-12	-15
16	-7	-9	-7	-5	-10	-14	-18	-24	16	-6	-8	-7	-5	-9	-13	-17	-23
	-10	-7	-8	-6	-8	-12	-16	-20		-8	-6	-8	-6	-8	-12	-15	-19
24-36	-6	-6	-7	-8	-12	-14	-18	-22	24-36	-4	-5	-7	-8	-11	-13	-16	-20
	-7	-6	-7	-8	-11	-13	-18	-23		-4	-4	-7	-8	-11	-13	-17	-21

SK11893

WAM_DC_00073GB_60HZ JM AEROFOIL
 January 2024



FAN CODE: 45JM/20/4/6/...
450mm 1680 rev/min 6 Blades 60 Hz

Performance Data ISO 5801

Performances shown is for installations type D – Ducted inlet, Ducted outlet. Performance ratings do not include the effects of appurtenances.

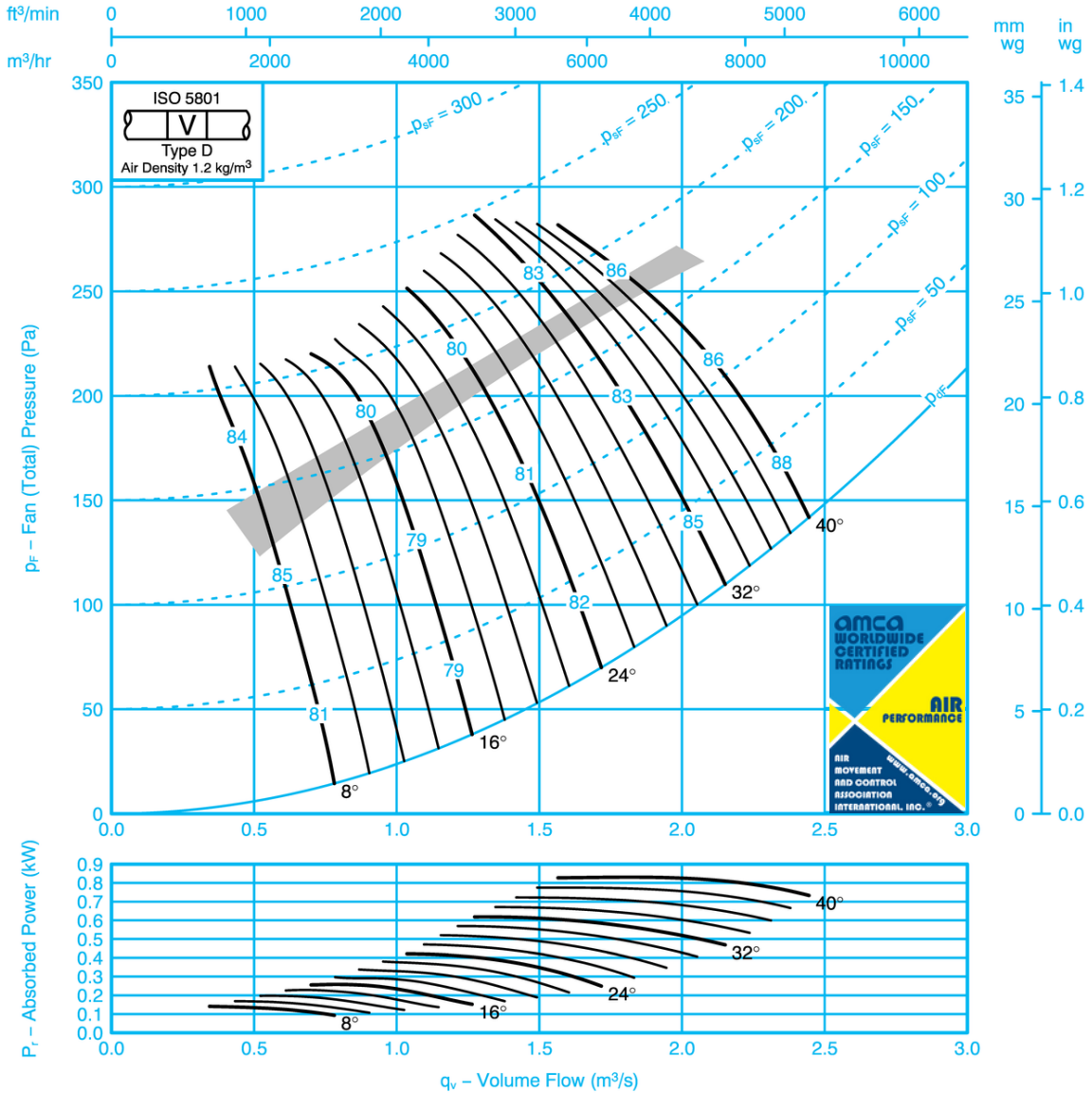

Sound Data ISO 5136

Single figures on performance curves are overall inlet sound power levels, derived from measurements taken in Woods laboratory specifically under ducted conditions. For sound power levels in eight octave bands, apply the following corrections to the overall level. Use upper corrections when operating point is above shaded area, or lower corrections when operating point is below shaded area.

Inlet Levels									Outlet Levels								
Pitch Angle	Octave Band Centre Frequency (Hz)								Pitch Angle	Octave Band Centre Frequency (Hz)							
	63	125	250	500	1k	2k	4k	8k		63	125	250	500	1k	2k	4k	8k
8	-18	-13	-11	-4	-4	-12	-21	-31	8	-16	-12	-10	-4	-4	-12	-21	-30
	-19	-16	-11	-5	-4	-9	-15	-22		-18	-14	-10	-5	-4	-8	-14	-20
16	-14	-10	-7	-5	-8	-11	-15	-21	16	-12	-9	-6	-5	-7	-10	-15	-20
	-15	-12	-7	-5	-7	-10	-13	-16		-14	-10	-6	-5	-7	-10	-12	-15
24-40	-7	-7	-7	-6	-10	-13	-17	-22	24-40	-6	-6	-7	-6	-9	-12	-16	-20
	-9	-8	-7	-7	-9	-12	-16	-20		-6	-6	-5	-7	-9	-12	-15	-19

SK11894

WAM_DC_00073GB_60HZ JM AEROFOIL
January 2024



FAN CODE: 45JM/16/2/5/...
450mm 3500 rev/min 5 Blades 60 Hz

Performance Data ISO 5801

Performance shown is for installations type D – Ducted inlet, Ducted outlet. Performance ratings do not include the effects of appurtenances.

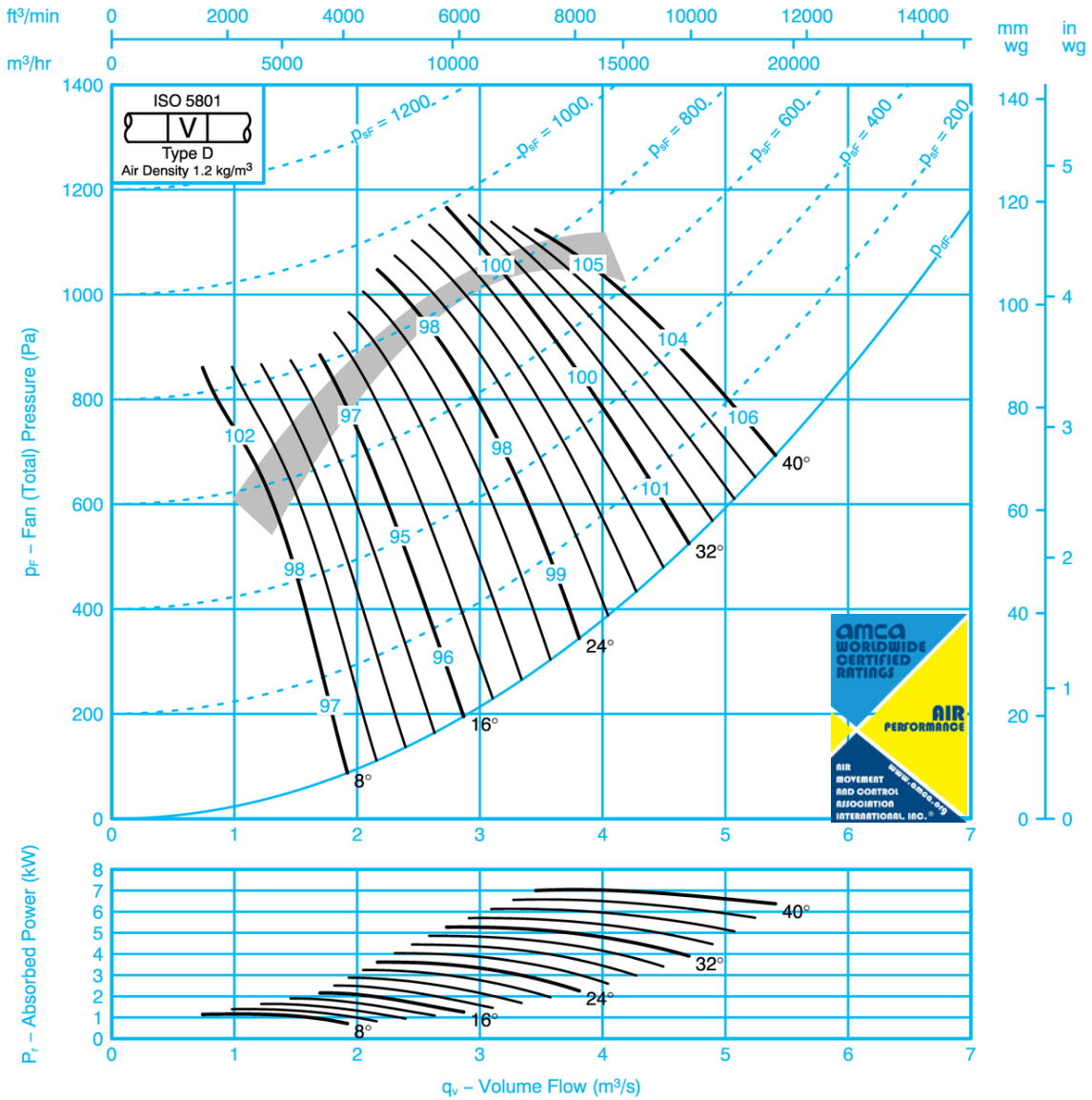

Sound Data ISO 5136

Single figures on performance curves are overall inlet sound power levels, derived from measurements taken in Woods laboratory specifically under ducted conditions. For sound power levels in eight octave bands, apply the following corrections to the overall level. Use upper corrections when operating point is above shaded area, or lower corrections when operating point is below shaded area.

Inlet Levels									Outlet Levels								
Pitch Angle	Octave Band Centre Frequency (Hz)								Pitch Angle	Octave Band Centre Frequency (Hz)							
	63	125	250	500	1k	2k	4k	8k		63	125	250	500	1k	2k	4k	8k
8	-16	-12	-7	-9	-6	-7	-13	-21	8	-15	-12	-5	-8	-5	-7	-12	-18
	-16	-14	-8	-9	-8	-5	-9	-14		-16	-14	-6	-9	-8	-4	-9	-13
16	-13	-11	-5	-7	-10	-8	-12	-17	16	-12	-11	-5	-7	-10	-8	-11	-15
	-14	-11	-4	-8	-11	-11	-12	-14		-14	-11	-3	-8	-11	-10	-11	-13
24-40	-9	-5	-6	-10	-13	-13	-16	-18	24-40	-8	-5	-6	-9	-13	-13	-15	-17
	-10	-6	-5	-9	-12	-13	-15	-18		-9	-6	-5	-9	-11	-12	-14	-16

SK11895

WAM_DC_00073GB_60HZ JM AEROFOIL
January 2024



FAN CODE: 45JM/20/2/3/...
450mm 3500 rev/min 3 Blades 60 Hz

Performance Data ISO 5801

Performances shown is for installation type D – Ducted inlet, Ducted outlet. Performance ratings do not include the effects of appurtenances.

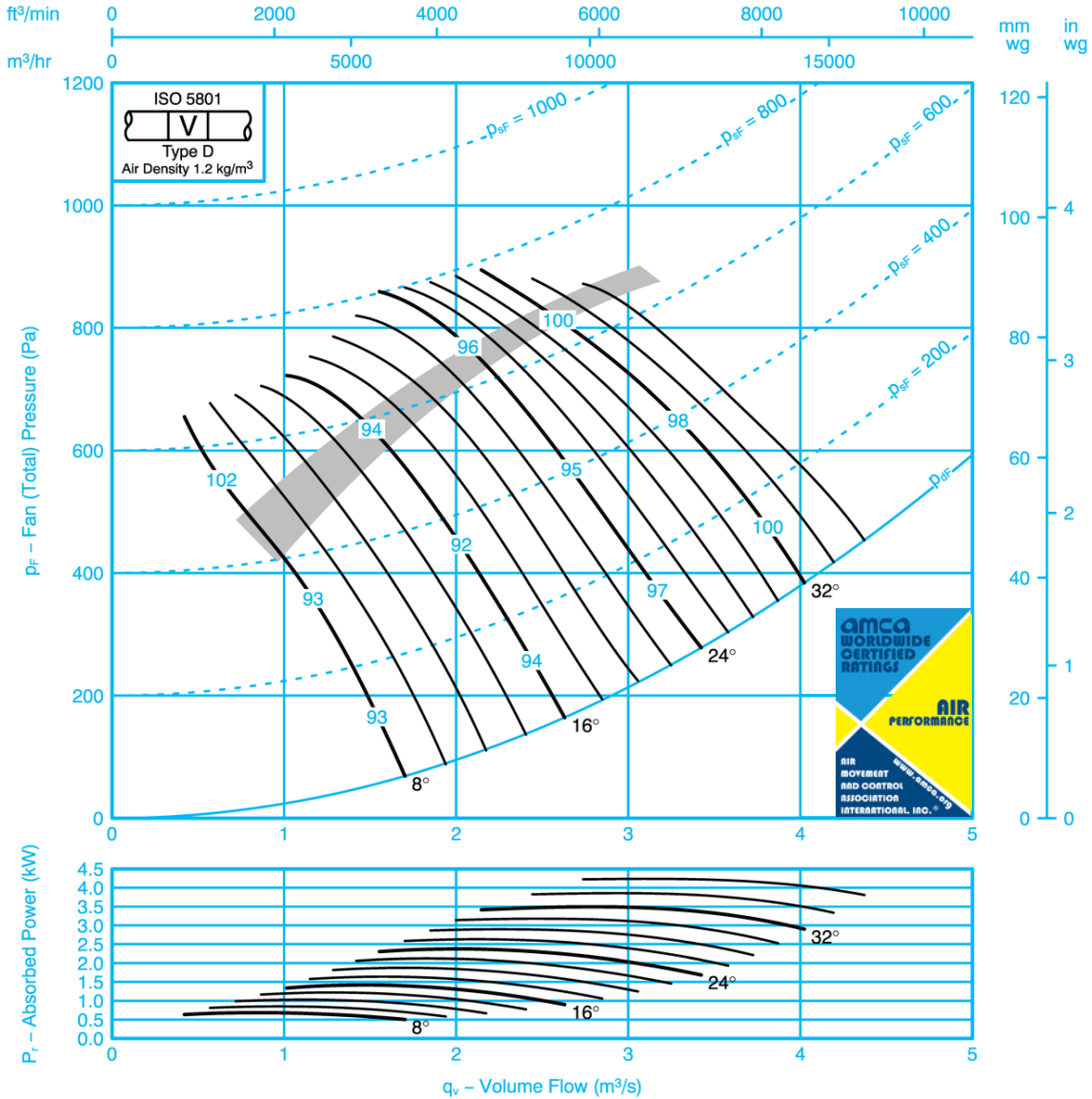

Sound Data ISO 5136

Single figures on performance curves are overall inlet sound power levels, derived from measurements taken in Woods laboratory specifically under ducted conditions. For sound power levels in eight octave bands, apply the following corrections to the overall level. Use upper corrections when operating point is above shaded area, or lower corrections when operating point is below shaded area.

Inlet Levels								Outlet Levels									
Pitch Angle	Octave Band Centre Frequency (Hz)								Pitch Angle	Octave Band Centre Frequency (Hz)							
	63	125	250	500	1k	2k	4k	8k		63	125	250	500	1k	2k	4k	8k
8	-18	-19	-16	-10	-4	-5	-14	-23	8	-15	-17	-14	-10	-3	-4	-13	-20
	-15	-15	-10	-8	-5	-6	-11	-14		-13	-13	-8	-5	-5	-5	-9	-11
16	-9	-8	-10	-7	-6	-10	-15	-19	16	-8	-6	-9	-7	-5	-10	-14	-18
	-11	-10	-7	-8	-6	-9	-13	-16		-10	-8	-6	-8	-6	-9	-12	-15
24-36	-9	-6	-7	-7	-9	-12	-15	-19	24-36	-8	-5	-6	-7	-9	-11	-13	-16
	-10	-7	-6	-7	-9	-11	-14	-19		-8	-5	-4	-7	-9	-10	-13	-16

SK11896

WAM_DC_00073GB_60HZ JM AEROFOIL
January 2024



FAN CODE: 45JM/20/2/6/...
450mm 3500 rev/min 6 Blades 60 Hz

Performance Data ISO 5801

Performance shown is for installations type D – Ducted inlet, Ducted outlet. Performance ratings do not include the effects of appurtenances.

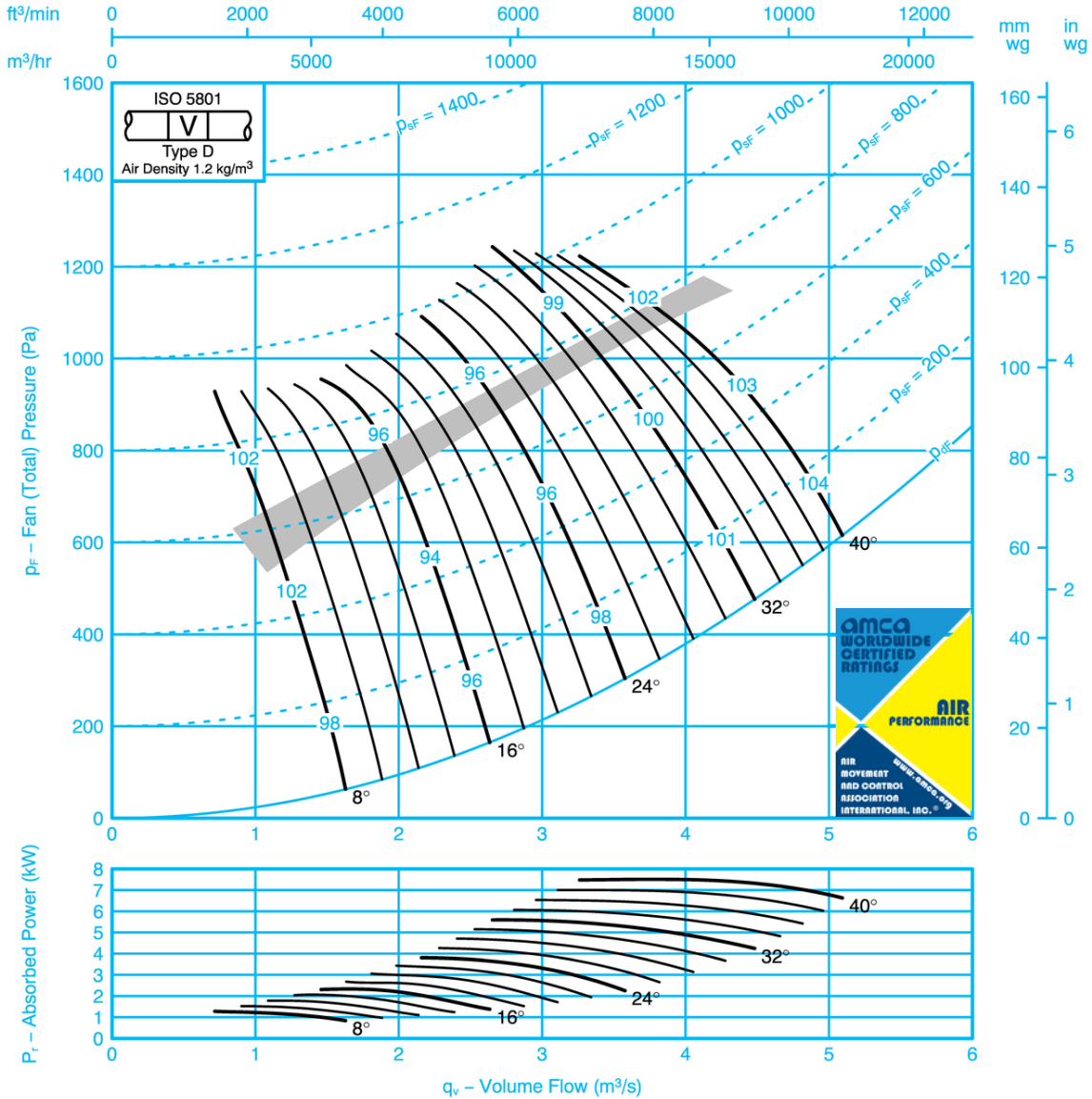

Sound Data ISO 5136

Single figures on performance curves are overall inlet sound power levels, derived from measurements taken in Woods laboratory specifically under ducted conditions. For sound power levels in eight octave bands, apply the following corrections to the overall level. Use upper corrections when operating point is above shaded area, or lower corrections when operating point is below shaded area.

Inlet Levels									Outlet Levels								
Pitch Angle	Octave Band Centre Frequency (Hz)								Pitch Angle	Octave Band Centre Frequency (Hz)							
	63	125	250	500	1k	2k	4k	8k		63	125	250	500	1k	2k	4k	8k
8	-16	-19	-14	-11	-4	-5	-14	-22	8	-13	-18	-12	-9	-4	-4	-13	-20
	-17	-19	-16	-10	-5	-4	-10	-16		-16	-19	-14	-9	-5	-3	-9	-14
16	-9	-15	-11	-7	-5	-9	-12	-16	16	-8	-15	-9	-6	-5	-8	-11	-15
	-12	-16	-12	-7	-5	-7	-11	-13		-10	-16	-10	-6	-5	-7	-10	-12
24-40	-9	-8	-8	-7	-7	-11	-14	-18	24-40	-7	-8	-7	-7	-6	-10	-12	-16
	-8	-10	-9	-7	-8	-10	-13	-16		-6	-9	-7	-6	-8	-9	-12	-15

SK11897

WAM_DC_00073GB_60HZ JM AEROFOIL
January 2024



FAN CODE: 50JM/16/6/5/...
500mm 1090 rev/min 5 Blades 60 Hz

Performance Data ISO 5801

Performances shown is for installations type D – Ducted inlet, Ducted outlet. Performance ratings do not include the effects of appurtenances.

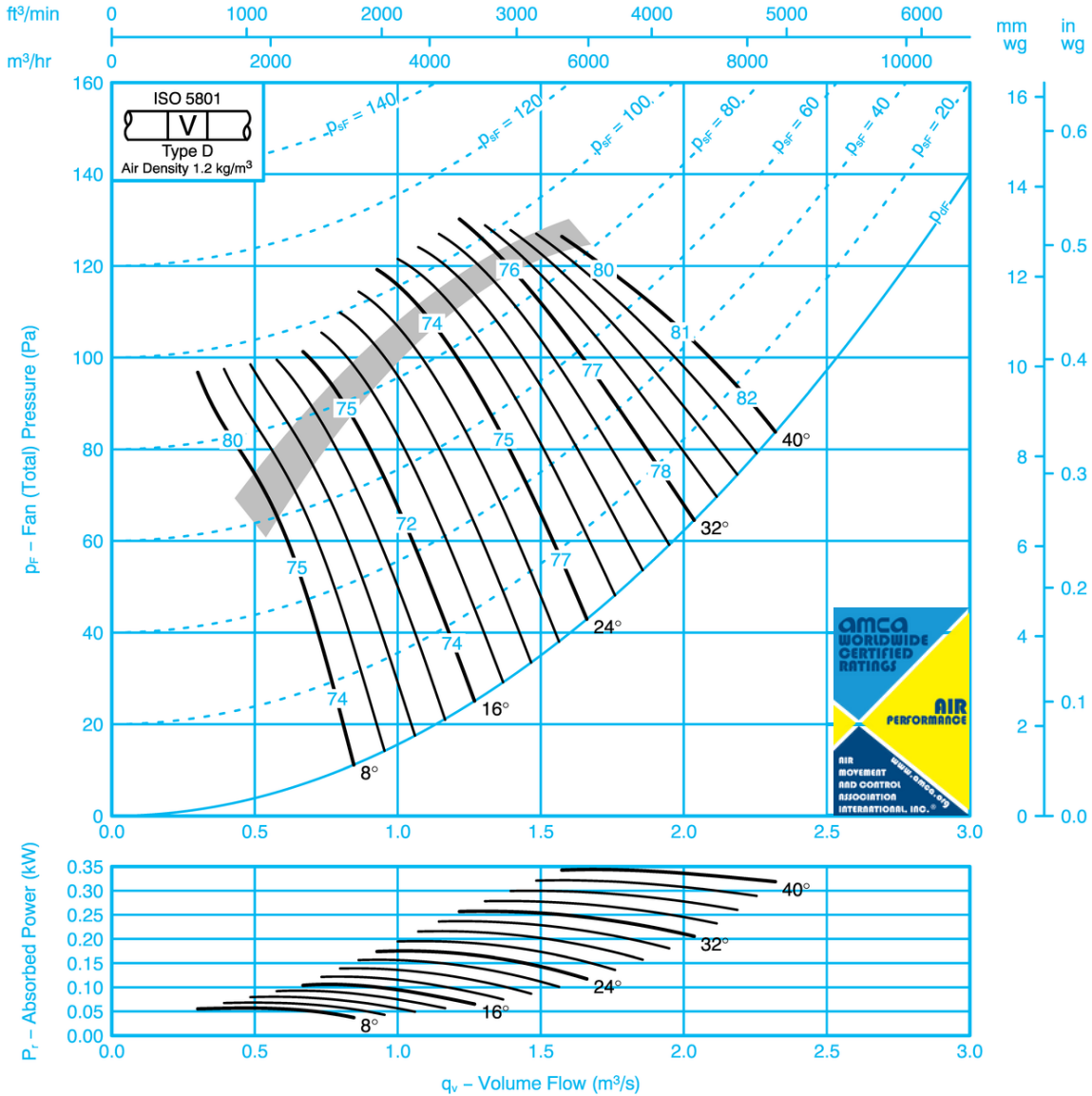

Sound Data ISO 5136

Single figures on performance curves are overall inlet sound power levels, derived from measurements taken in Woods laboratory specifically under ducted conditions. For sound power levels in eight octave bands, apply the following corrections to the overall level. Use upper corrections when operating point is above shaded area, or lower corrections when operating point is below shaded area.

Inlet Levels									Outlet Levels								
Pitch Angle	Octave Band Centre Frequency (Hz)								Pitch Angle	Octave Band Centre Frequency (Hz)							
	63	125	250	500	1k	2k	4k	8k		63	125	250	500	1k	2k	4k	8k
8	-12	-8	-7	-4	-9	-16	-24	-31	8	-11	-7	-7	-4	-9	-16	-23	-29
	-14	-7	-9	-5	-7	-11	-16	-24		-14	-6	-9	-5	-7	-10	-16	-23
16	-10	-7	-9	-4	-9	-14	-20	-27	16	-10	-7	-9	-4	-8	-14	-20	-25
	-10	-3	-8	-9	-11	-13	-17	-23		-9	-3	-8	-9	-11	-13	-16	-22
24-40	-5	-6	-9	-9	-12	-14	-18	-22	24-40	-3	-6	-9	-9	-12	-14	-17	-21
	-5	-5	-9	-9	-13	-15	-20	-25		-5	-4	-9	-9	-13	-15	-19	-24

SK11899

WAM_DC_00073GB_60HZ JM AEROFOIL
January 2024



Performance Data ISO 5801

Performances shown is for installations type D – Ducted inlet, Ducted outlet. Performance ratings do not include the effects of appurtenances.

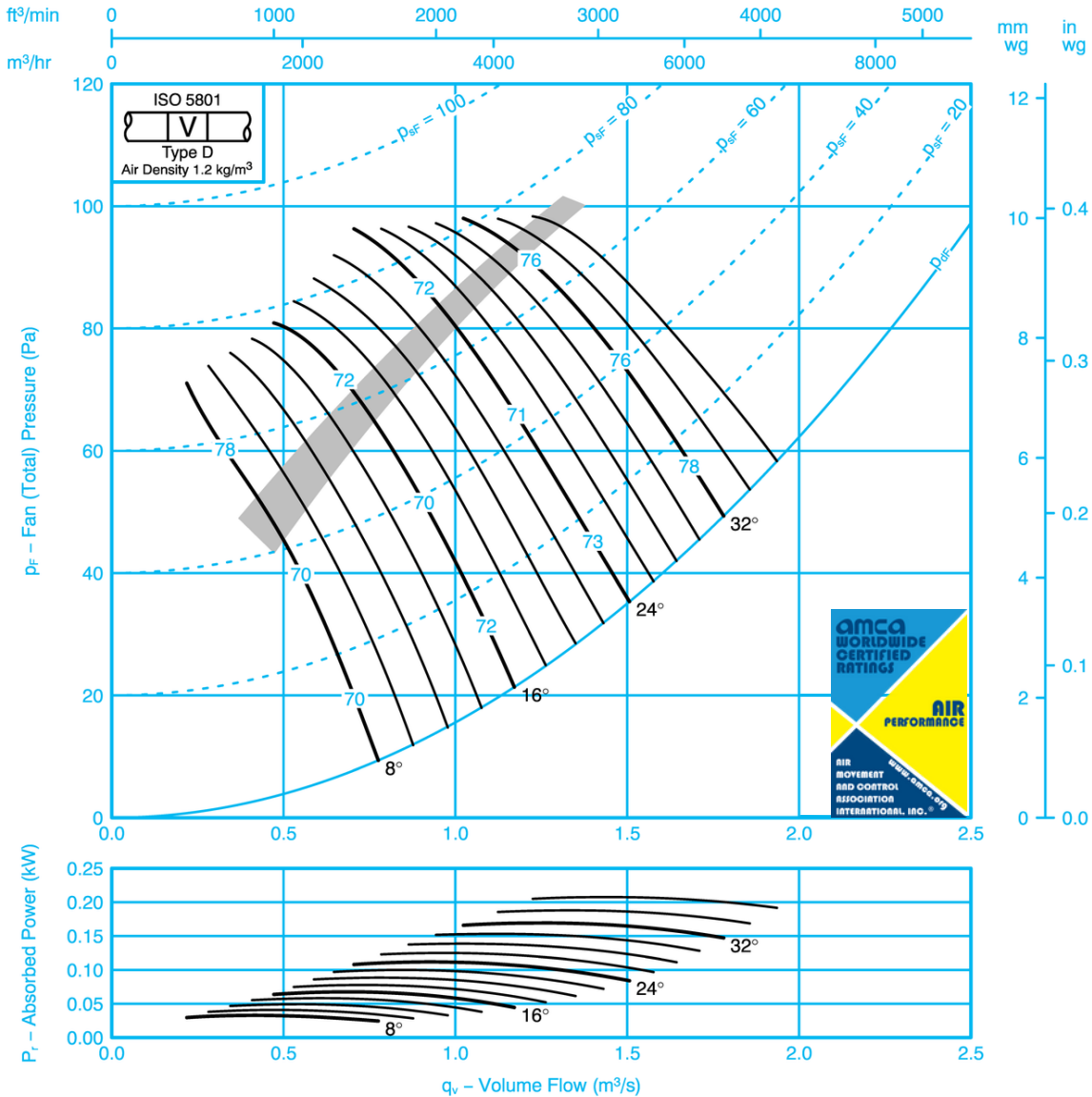

Sound Data ISO 5136

Single figures on performance curves are overall inlet sound power levels, derived from measurements taken in Woods laboratory specifically under ducted conditions. For sound power levels in eight octave bands, apply the following corrections to the overall level. Use upper corrections when operating point is above shaded area, or lower corrections when operating point is below shaded area.

Inlet Levels									Outlet Levels								
Pitch Angle	Octave Band Centre Frequency (Hz)								Pitch Angle	Octave Band Centre Frequency (Hz)							
	63	125	250	500	1k	2k	4k	8k		63	125	250	500	1k	2k	4k	8k
8	-16	-13	-6	-3	-9	-18	-27	-37	8	-13	-13	-6	-3	-9	-18	-26	-35
	-8	-9	-6	-6	-9	-13	-16	-20		-6	-9	-6	-6	-8	-12	-14	-17
16	-8	-6	-5	-8	-12	-17	-21	-26	16	-6	-6	-5	-8	-12	-16	-20	-25
	-5	-8	-6	-8	-11	-16	-19	-24		-3	-8	-6	-8	-12	-16	-18	-23
24-36	-5	-6	-7	-10	-12	-16	-19	-24	24-36	-3	-6	-7	-9	-11	-15	-18	-21
	-4	-8	-7	-10	-12	-17	-21	-26		-1	-7	-7	-10	-12	-16	-20	-24



Performance Data ISO 5801

Performances shown is for installations type D – Ducted inlet, Ducted outlet. Performance ratings do not include the effects of appurtenances.

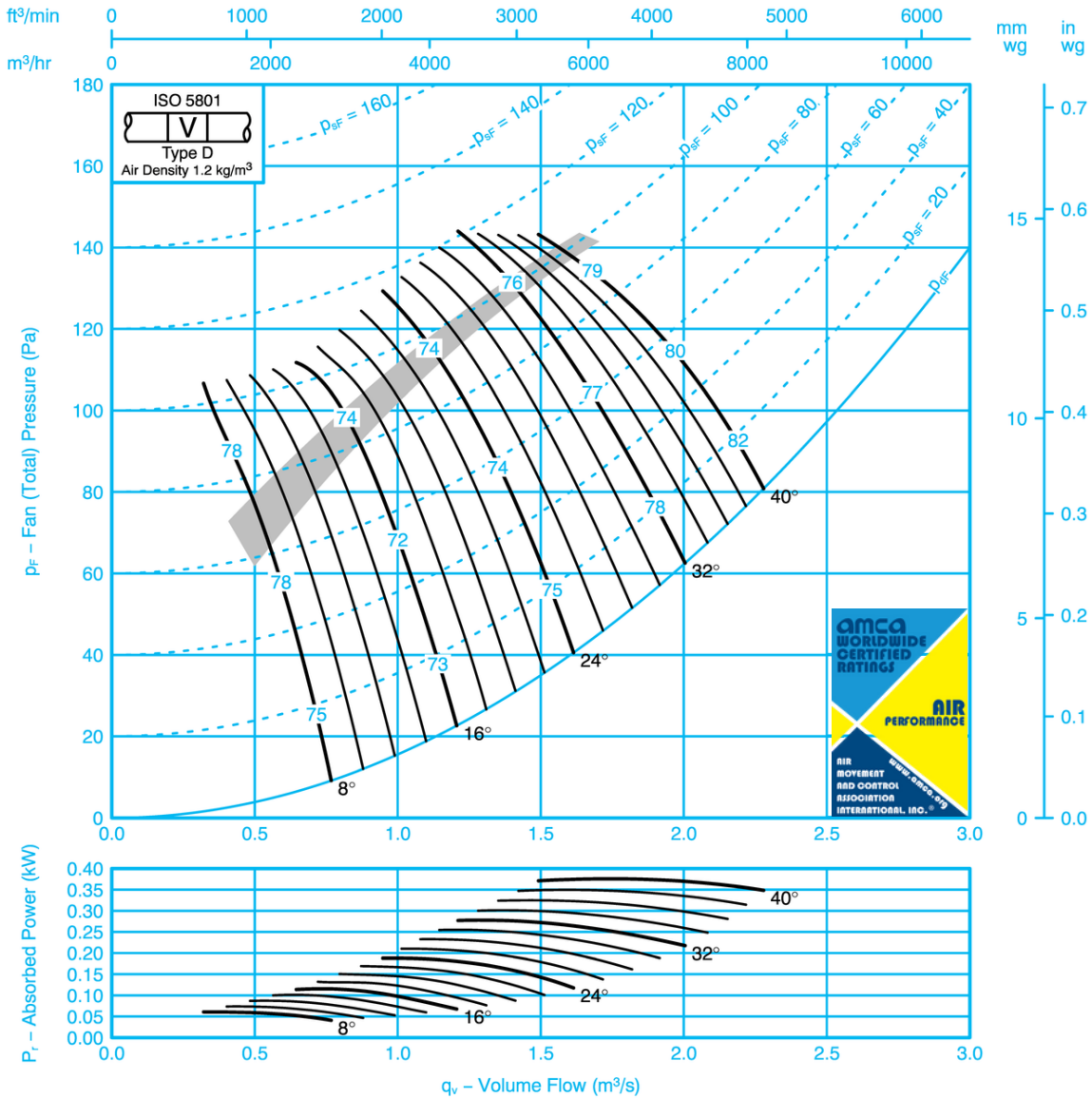

Sound Data ISO 5136

Single figures on performance curves are overall inlet sound power levels, derived from measurements taken in Woods laboratory specifically under ducted conditions. For sound power levels in eight octave bands, apply the following corrections to the overall level. Use upper corrections when operating point is above shaded area, or lower corrections when operating point is below shaded area.

Inlet Levels									Outlet Levels								
Pitch Angle	Octave Band Centre Frequency (Hz)								Pitch Angle	Octave Band Centre Frequency (Hz)							
	63	125	250	500	1k	2k	4k	8k		63	125	250	500	1k	2k	4k	8k
8	-18	-12	-7	-3	-7	-16	-25	-35	8	-16	-10	-7	-3	-7	-16	-25	-34
	-19	-11	-7	-4	-6	-13	-18	-24		-17	-9	-7	-4	-6	-12	-17	-22
16	-14	-6	-5	-7	-9	-14	-20	-25	16	-13	-5	-5	-7	-9	-14	-19	-24
	-14	-5	-6	-7	-9	-13	-16	-19		-12	-4	-6	-7	-9	-13	-15	-19
24-40	-7	-6	-7	-9	-11	-15	-19	-23	24-40	-5	-4	-7	-9	-11	-14	-17	-21
	-7	-5	-7	-9	-11	-15	-19	-22		-5	-3	-7	-9	-11	-15	-18	-21



FAN CODE: 50JM/16/4/5/...
500mm 1700 rev/min 5 Blades 60 Hz

Performance Data ISO 5801

Performance shown is for installations type D – Ducted inlet, Ducted outlet. Performance ratings do not include the effects of appurtenances.

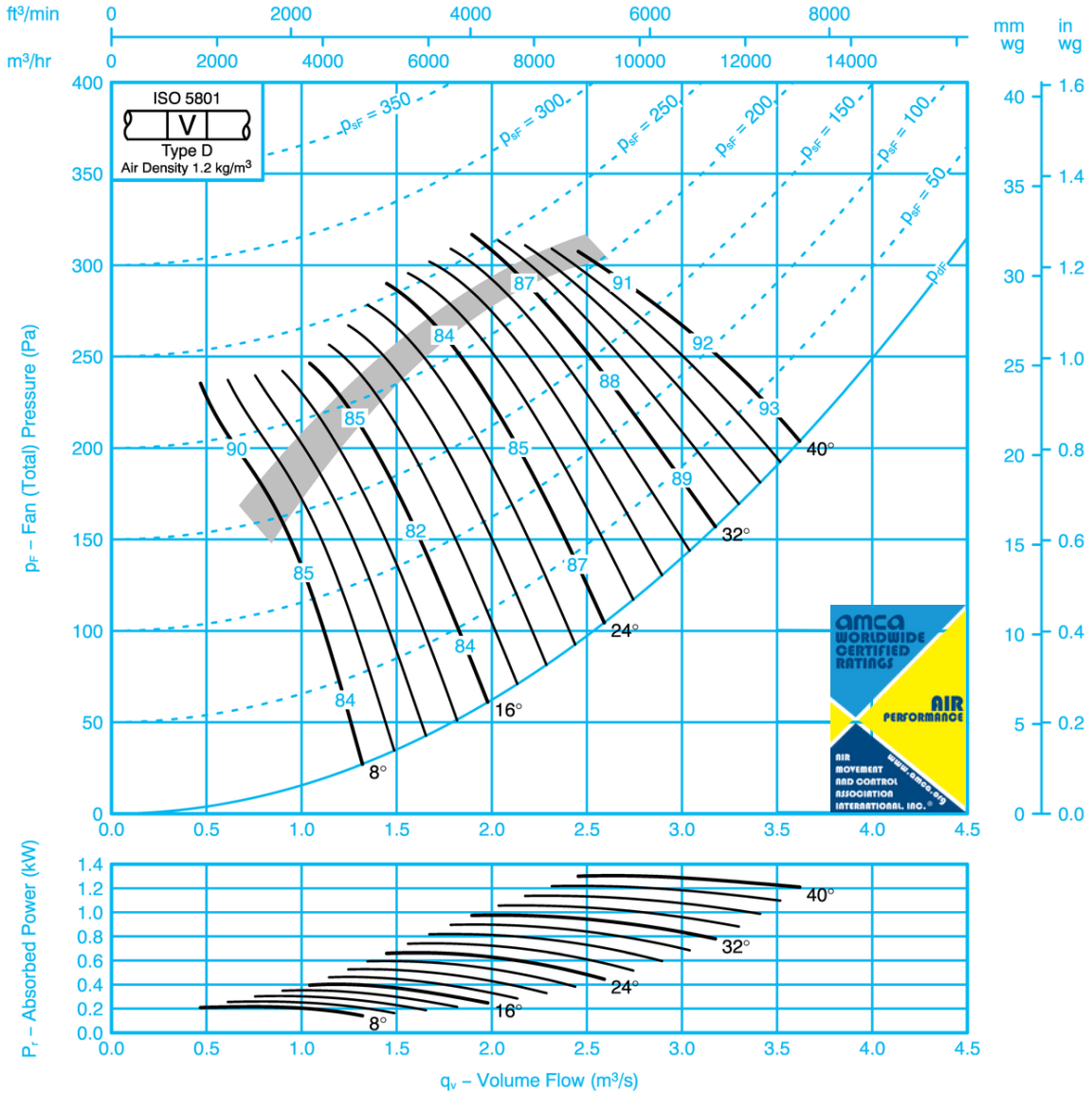

Sound Data ISO 5136

Single figures on performance curves are overall inlet sound power levels, derived from measurements taken in Woods laboratory specifically under ducted conditions. For sound power levels in eight octave bands, apply the following corrections to the overall level. Use upper corrections when operating point is above shaded area, or lower corrections when operating point is below shaded area.

Inlet Levels									Outlet Levels								
Pitch Angle	Octave Band Centre Frequency (Hz)								Pitch Angle	Octave Band Centre Frequency (Hz)							
	63	125	250	500	1k	2k	4k	8k		63	125	250	500	1k	2k	4k	8k
8	-15	-10	-10	-5	-6	-11	-19	-26	8	-14	-8	-10	-4	-6	-11	-18	-24
	-15	-8	-10	-8	-5	-8	-13	-19		-15	-8	-10	-8	-5	-7	-12	-17
16	-14	-8	-9	-8	-6	-11	-17	-23	16	-12	-7	-9	-7	-6	-10	-15	-21
	-12	-4	-8	-9	-11	-12	-15	-20		-11	-4	-8	-9	-10	-11	-14	-18
24-40	-6	-5	-10	-11	-12	-14	-17	-21	24-40	-4	-5	-9	-10	-11	-14	-16	-19
	-6	-4	-9	-10	-12	-15	-18	-23		-6	-4	-9	-10	-12	-14	-16	-21

SK11902

WAM_DC_00073GB_60HZ JM AEROFOIL
January 2024



FAN CODE: 50JM/20/4/3/...
500mm 1700 rev/min 3 Blades 60 Hz

Performance Data ISO 5801

Performances shown is for installations type D – Ducted inlet, Ducted outlet. Performance ratings do not include the effects of appurtenances.

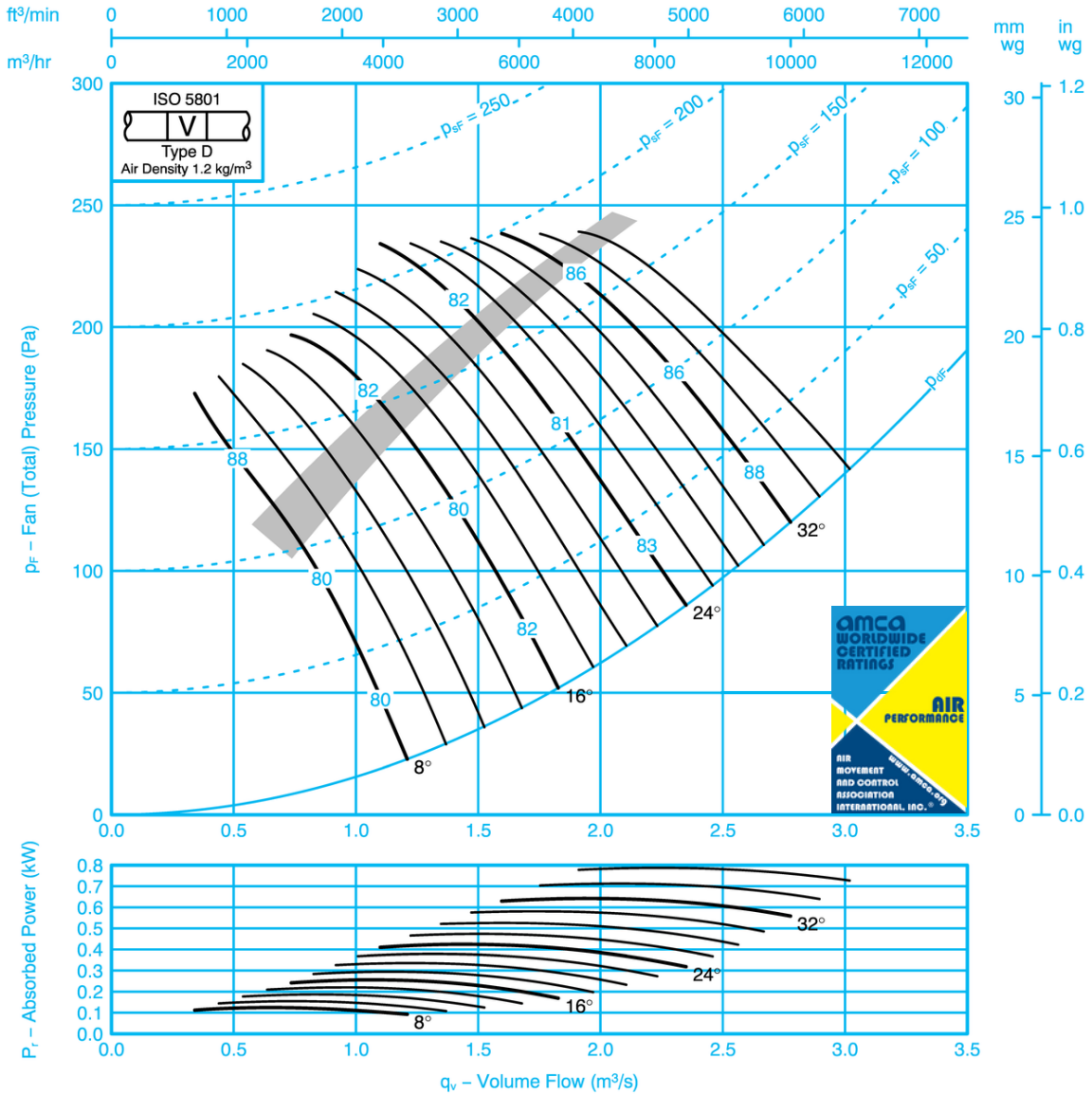

Sound Data ISO 5136

Single figures on performance curves are overall inlet sound power levels, derived from measurements taken in Woods laboratory specifically under ducted conditions. For sound power levels in eight octave bands, apply the following corrections to the overall level. Use upper corrections when operating point is above shaded area, or lower corrections when operating point is below shaded area.

Inlet Levels									Outlet Levels								
Pitch Angle	Octave Band Centre Frequency (Hz)								Pitch Angle	Octave Band Centre Frequency (Hz)							
	63	125	250	500	1k	2k	4k	8k		63	125	250	500	1k	2k	4k	8k
8	-20	-16	-11	-4	-4	-11	-21	-30	8	-17	-14	-11	-4	-4	-11	-20	-28
	-14	-9	-8	-6	-6	-10	-14	-17		-11	-7	-8	-6	-6	-9	-12	-15
16	-10	-8	-6	-5	-9	-14	-18	-23	16	-8	-8	-6	-5	-9	-13	-17	-22
	-10	-6	-7	-6	-9	-13	-17	-21		-8	-5	-7	-6	-9	-13	-16	-20
24-36	-7	-6	-6	-8	-11	-13	-17	-22	24-36	-5	-5	-6	-8	-10	-12	-16	-19
	-7	-5	-7	-8	-10	-14	-18	-23		-5	-4	-7	-8	-10	-13	-17	-21



FAN CODE: 50JM/20/4/6/...
500mm 1700 rev/min 6 Blades 60 Hz

Performance Data ISO 5801

Performance shown is for installation type D – Ducted inlet, Ducted outlet. Performance ratings do not include the effects of appurtenances.

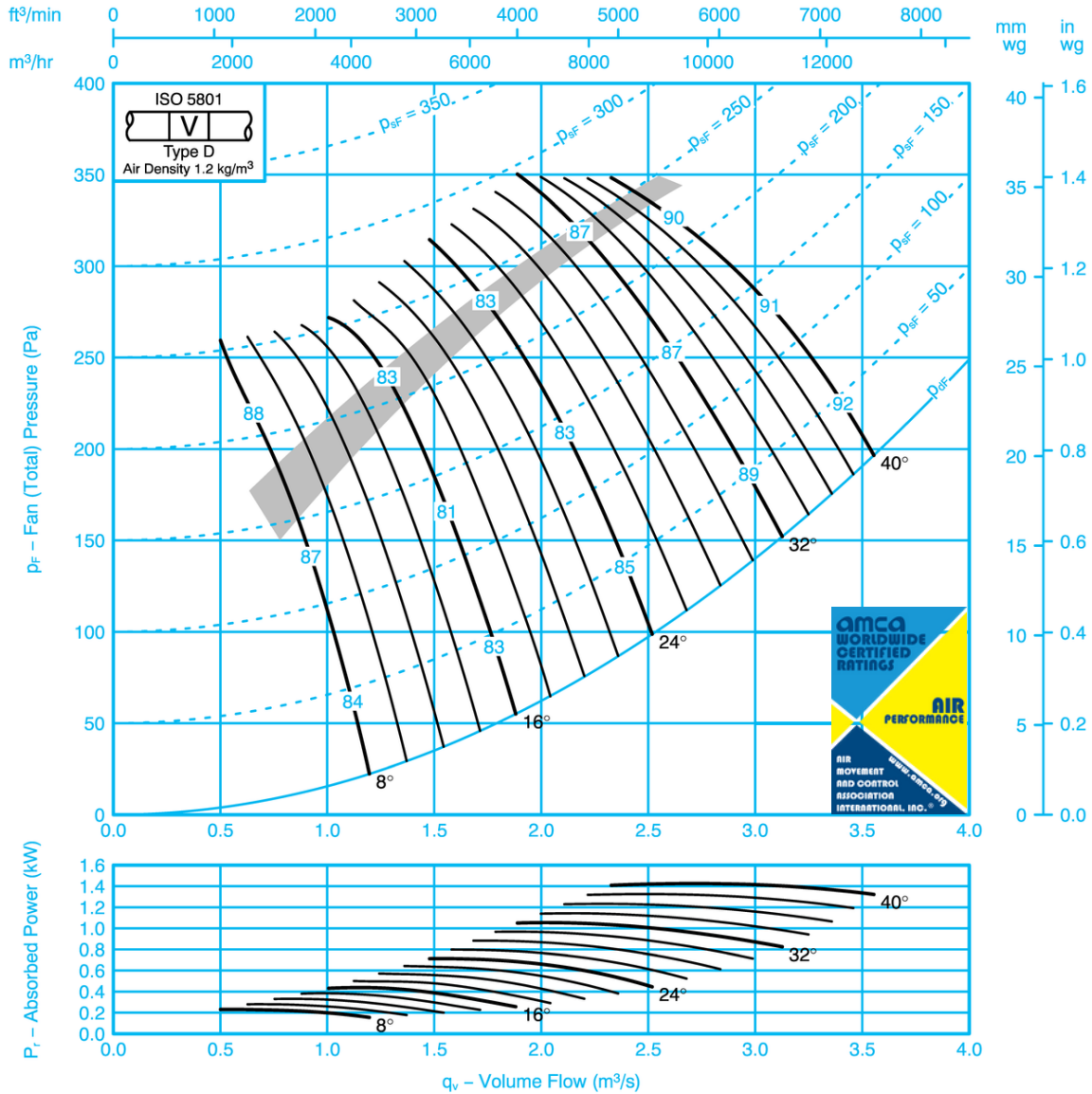

Sound Data ISO 5136

Single figures on performance curves are overall inlet sound power levels, derived from measurements taken in Woods laboratory specifically under ducted conditions. For sound power levels in eight octave bands, apply the following corrections to the overall level. Use upper corrections when operating point is above shaded area, or lower corrections when operating point is below shaded area.

Inlet Levels								Outlet Levels									
Pitch Angle	Octave Band Centre Frequency (Hz)								Pitch Angle	Octave Band Centre Frequency (Hz)							
	63	125	250	500	1k	2k	4k	8k		63	125	250	500	1k	2k	4k	8k
8	-20	-17	-11	-6	-3	-10	-19	-29	8	-18	-15	-10	-6	-3	-9	-19	-28
	-19	-17	-10	-6	-4	-8	-15	-20		-18	-15	-9	-6	-4	-8	-13	-18
16	-15	-12	-6	-5	-7	-11	-15	-22	16	-13	-10	-6	-5	-6	-10	-15	-21
	-13	-12	-6	-6	-7	-10	-14	-17		-12	-10	-5	-6	-7	-10	-13	-16
24-40	-7	-7	-7	-7	-10	-13	-17	-21	24-40	-5	-6	-6	-7	-10	-12	-15	-19
	-7	-7	-7	-8	-10	-13	-17	-21		-5	-5	-5	-8	-10	-13	-16	-20

SK11904

WAM_DC_00073GB_60HZ JM AEROFOIL
January 2024



Performance Data ISO 5801

Performance shown is for installations type D – Ducted inlet, Ducted outlet. Performance ratings do not include the effects of appurtenances.

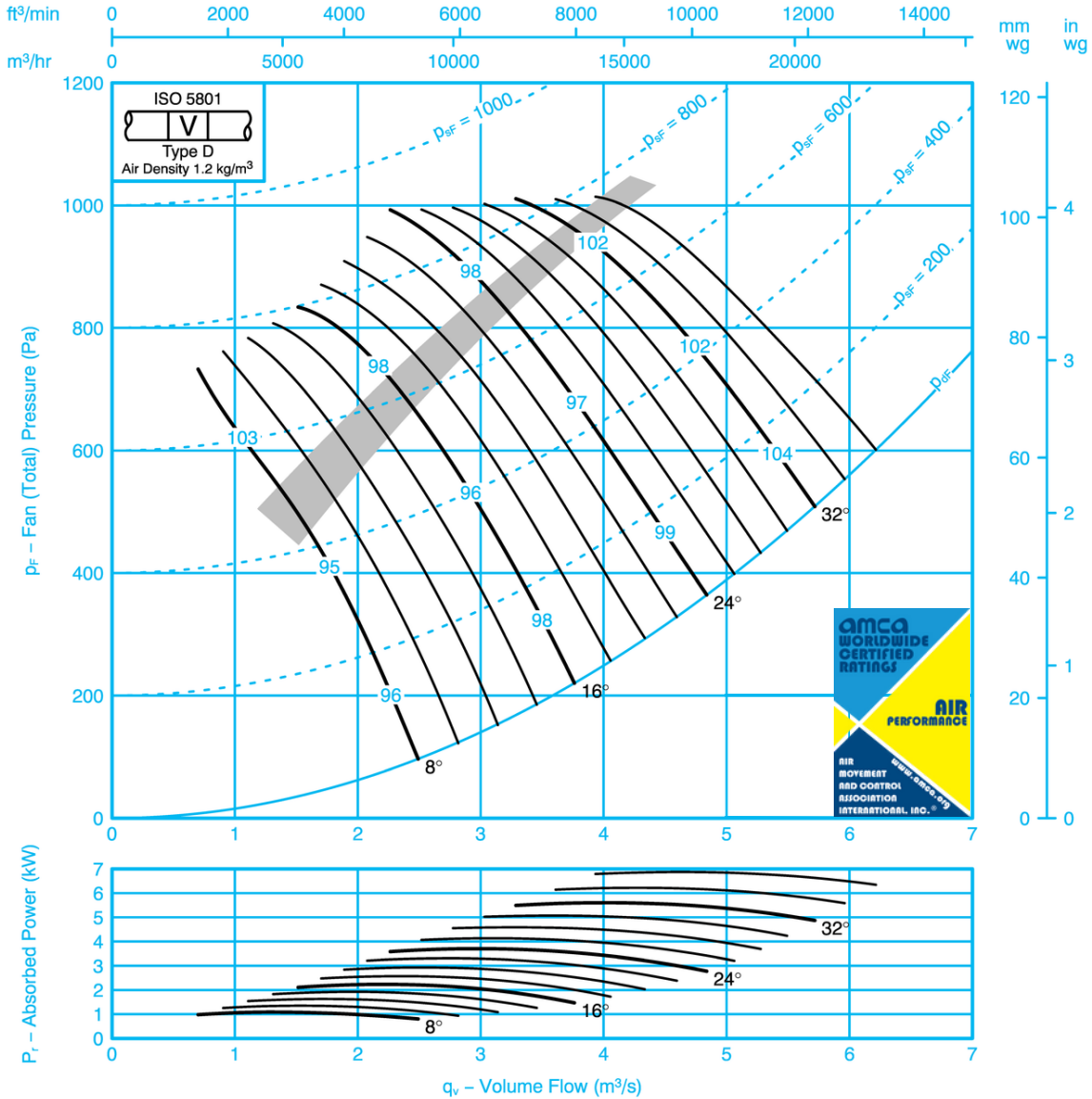

If it is intended to run this fan in reverse for other than emergency operation, please refer to Woods Air Movement.

Sound Data ISO 5136

Single figures on performance curves are overall inlet sound power levels, derived from measurements taken in Woods laboratory specifically under ducted conditions. For sound power levels in eight octave bands, apply the following corrections to the overall level. Use upper corrections when operating point is above shaded area, or lower corrections when operating point is below shaded area.

Inlet Levels								Outlet Levels									
Pitch Angle	Octave Band Centre Frequency (Hz)								Pitch Angle	Octave Band Centre Frequency (Hz)							
	63	125	250	500	1k	2k	4k	8k		63	125	250	500	1k	2k	4k	8k
8	-20	-20	-16	-11	-5	-4	-13	-22	8	-17	-18	-14	-10	-4	-3	-11	-19
	-14	-14	-9	-8	-6	-7	-11	-14		-13	-11	-6	-8	-6	-6	-11	-11
16	-11	-10	-9	-6	-6	-10	-15	-19	16	-9	-8	-8	-6	-5	-9	-14	-17
	-11	-10	-6	-8	-7	-10	-14	-18		-9	-8	-4	-7	-7	-9	-13	-16
24-36	-10	-8	-7	-7	-9	-11	-14	-18	24-36	-8	-6	-6	-6	-9	-10	-12	-15
	-10	-8	-6	-8	-9	-11	-15	-19		-7	-6	-4	-8	-9	-10	-14	-17

SK11905

WAM_DC_00073GB_60HZ JM AEROFOIL
January 2024



FAN CODE: 50JM/20/2/6/...
500mm 3500 rev/min 6 Blades 60 Hz

Performance Data ISO 5801

Performances shown is for installations type D – Ducted inlet, Ducted outlet. Performance ratings do not include the effects of appurtenances.

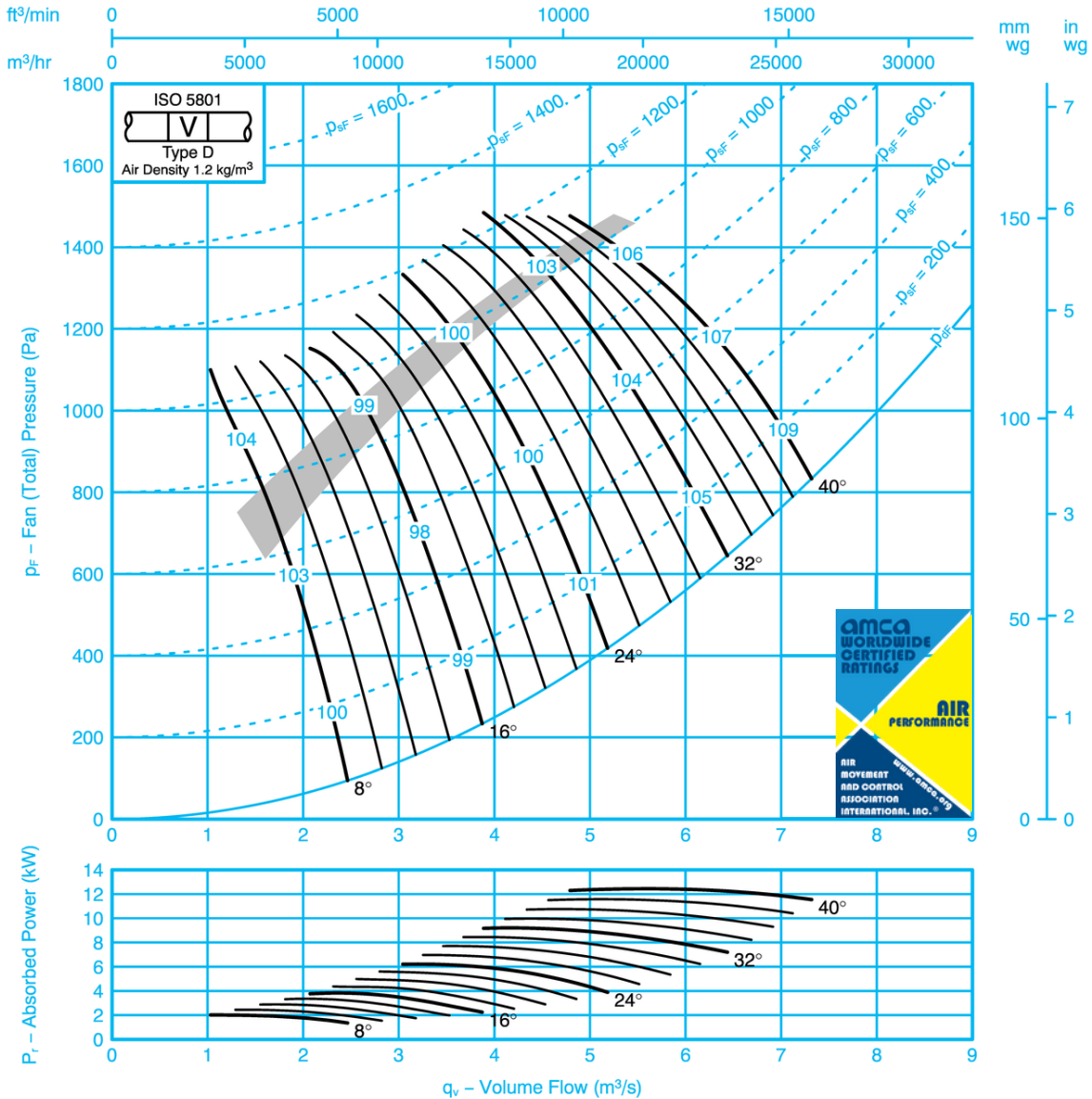

If it is intended to run this fan in reverse for other than emergency operation, please refer to Woods Air Movement.

Sound Data ISO 5136

Single figures on performance curves are overall inlet sound power levels, derived from measurements taken in Woods laboratory specifically under ducted conditions. For sound power levels in eight octave bands, apply the following correction to the overall level. Use upper corrections when operating point is above shaded area, or lower corrections when operating point is below shaded area.

Inlet Levels									Outlet Levels								
Pitch Angle	Octave Band Centre Frequency (Hz)								Pitch Angle	Octave Band Centre Frequency (Hz)							
	63	125	250	500	1k	2k	4k	8k		63	125	250	500	1k	2k	4k	8k
8	-18	-21	-18	-11	-6	-4	-11	-20	8	-14	-20	-16	-9	-5	-3	-10	-18
	-16	-20	-17	-10	-6	-4	-9	-15		-14	-20	-15	-8	-6	-3	-8	-13
16	-10	-16	-13	-6	-6	-8	-12	-17	16	-9	-16	-11	-5	-5	-7	-11	-16
	-10	-14	-12	-6	-6	-8	-12	-14		-9	-14	-10	-4	-6	-8	-11	-13
24-40	-8	-8	-8	-7	-8	-11	-14	-17	24-40	-7	-7	-7	-6	-8	-10	-13	-16
	-8	-8	-8	-7	-9	-11	-15	-18		-6	-8	-7	-6	-9	-11	-13	-16



FAN CODE: 56JM/16/8/5/...
560mm 800 rev/min 5 Blades 60 Hz

Performance Data ISO 5801

Performance shown is for installations type D – Ducted inlet, Ducted outlet. Performance ratings do not include the effects of appurtenances.

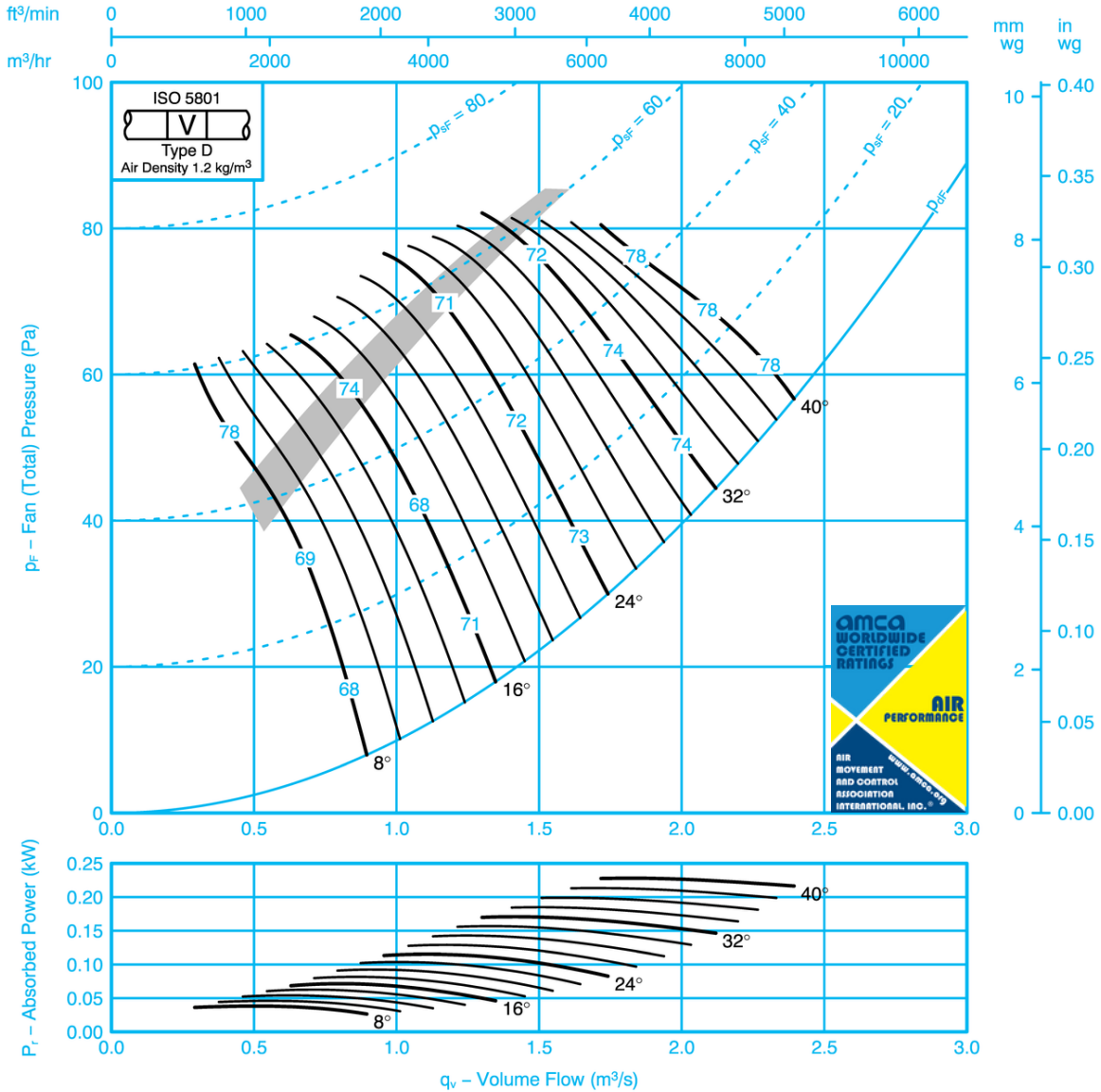

Sound Data ISO 5136

Single figures on performance curves are overall inlet sound power levels, derived from measurements taken in Woods laboratory specifically under ducted conditions. For sound power levels in eight octave bands, apply the following corrections to the overall level. Use upper corrections when operating point is above shaded area, or lower corrections when operating point is below shaded area.

Inlet Levels									Outlet Levels								
Pitch Angle	Octave Band Centre Frequency (Hz)								Pitch Angle	Octave Band Centre Frequency (Hz)							
	63	125	250	500	1k	2k	4k	8k		63	125	250	500	1k	2k	4k	8k
8	-11	-11	-5	-4	-9	-16	-24	-34	8	-10	-11	-5	-4	-9	-16	-23	-32
	-5	-11	-9	-6	-7	-12	-18	-27		-4	-11	-9	-6	-7	-11	-17	-25
16	-10	-12	-5	-4	-9	-16	-23	-33	16	-10	-12	-5	-4	-9	-16	-22	-32
	-3	-9	-9	-11	-13	-16	-20	-27		-2	-9	-9	-11	-13	-16	-19	-26
24-40	-3	-9	-8	-10	-13	-15	-19	-24	24-40	-2	-9	-8	-10	-13	-15	-18	-23
	-2	-8	-9	-11	-14	-18	-22	-29		-2	-8	-9	-11	-15	-18	-21	-27

SK11907

WAM_DC_00073GB_60HZ JM AEROFOIL
January 2024



FAN CODE: 56JM/16/6/5/...
560mm 1070 rev/min 5 Blades 60 Hz

Performance Data ISO 5801

Performances shown is for installations type D – Ducted inlet, Ducted outlet. Performance ratings do not include the effects of appurtenances.

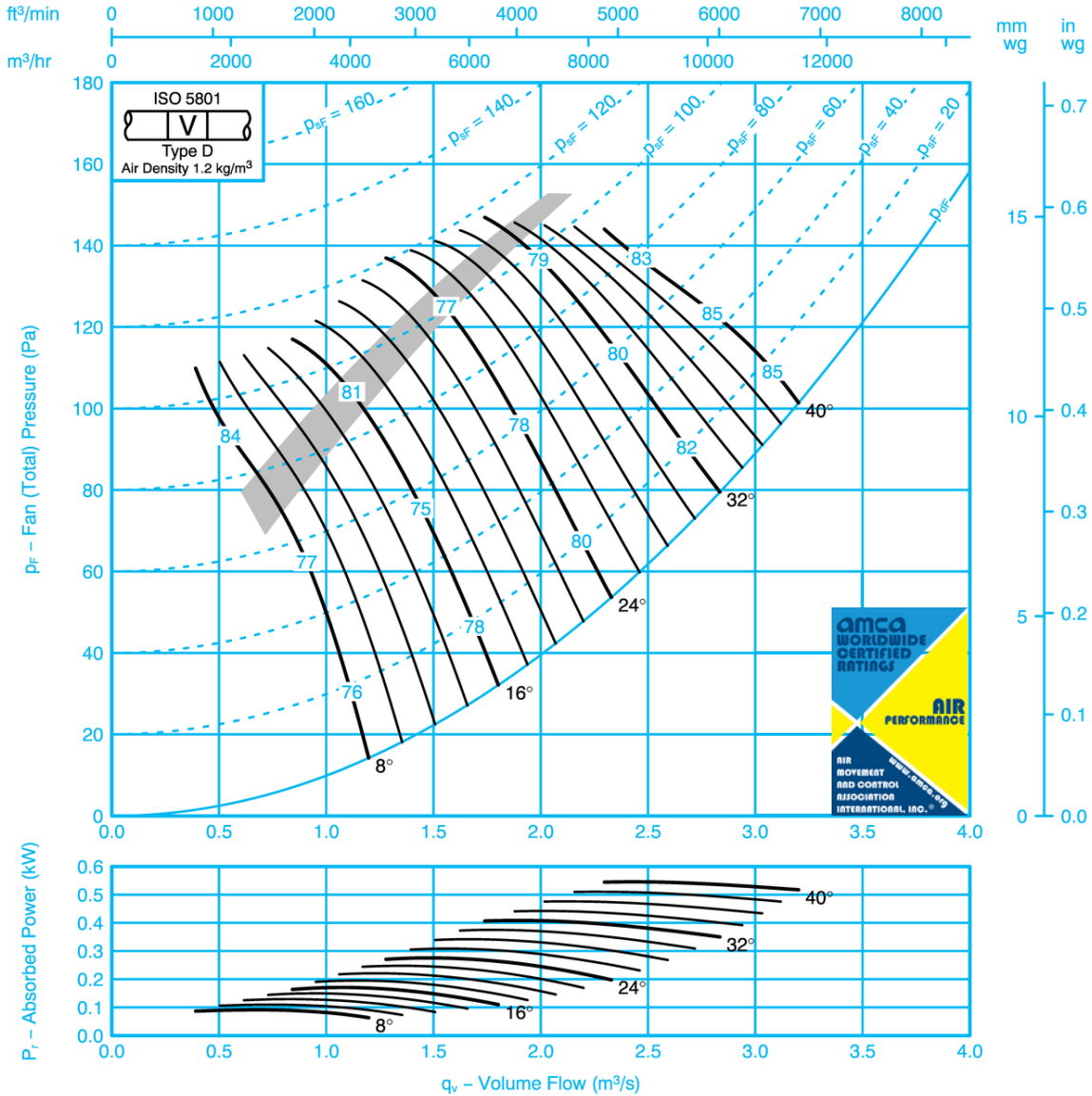

Sound Data ISO 5136

Single figures on performance curves are overall inlet sound power levels, derived from measurements taken in Woods laboratory specifically under ducted conditions. For sound power levels in eight octave bands, apply the following corrections to the overall level. Use upper corrections when operating point is above shaded area, or lower corrections when operating point is below shaded area.

Inlet Levels									Outlet Levels								
Pitch Angle	Octave Band Centre Frequency (Hz)								Pitch Angle	Octave Band Centre Frequency (Hz)							
	63	125	250	500	1k	2k	4k	8k		63	125	250	500	1k	2k	4k	8k
8	-15	-11	-7	-3	-8	-14	-22	-30	8	-13	-11	-7	-3	-8	-14	-21	-28
	-16	-8	-10	-6	-6	-10	-15	-23		-15	-8	-10	-5	-6	-9	-14	-21
16	-16	-11	-8	-3	-8	-14	-21	-29	16	-15	-11	-8	-3	-8	-14	-20	-27
	-10	-4	-8	-8	-11	-13	-17	-23		-10	-4	-8	-8	-11	-13	-16	-22
24-40	-7	-5	-8	-8	-11	-14	-17	-21	24-40	-6	-5	-8	-8	-11	-14	-16	-20
	-7	-4	-8	-9	-13	-16	-20	-25		-6	-4	-8	-9	-13	-16	-19	-23

SK11910

WAM_DC_00073GB_60HZ JM AEROFOIL
January 2024



FAN CODE: 56JM/20/6/3/...
560mm 1070 rev/min 3 Blades 60 Hz

Performance Data ISO 5801

Performance shown is for installations type D – Ducted inlet, Ducted outlet. Performance ratings do not include the effects of appurtenances.

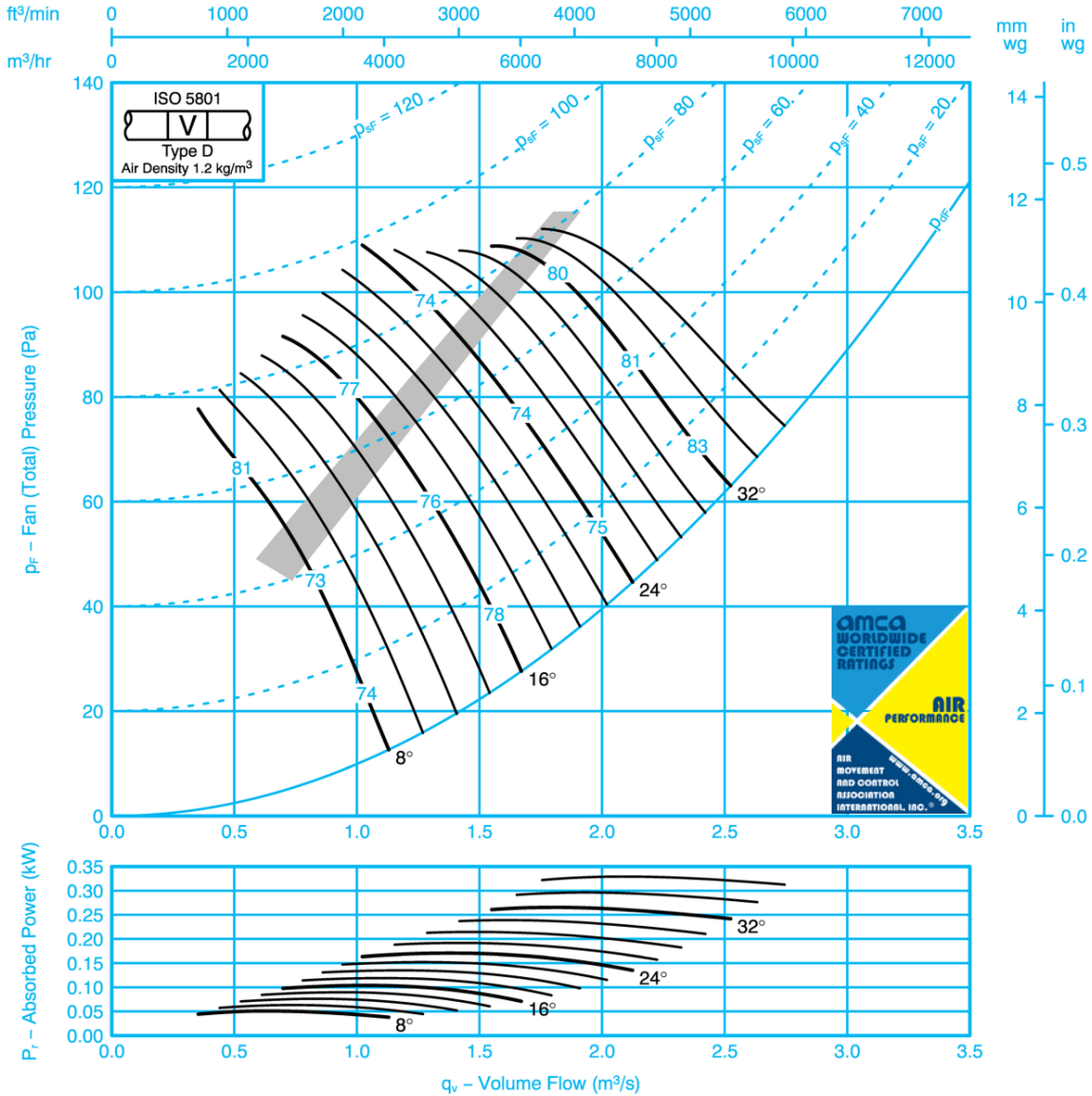

Sound Data ISO 5136

Single figures on performance curves are overall inlet sound power levels, derived from measurements taken in Woods laboratory specifically under ducted conditions. For sound power levels in eight octave bands, apply the following corrections to the overall level. Use upper corrections when operating point is above shaded area, or lower corrections when operating point is below shaded area.

Inlet Levels								Outlet Levels									
Pitch Angle	Octave Band Centre Frequency (Hz)								Pitch Angle	Octave Band Centre Frequency (Hz)							
	63	125	250	500	1k	2k	4k	8k		63	125	250	500	1k	2k	4k	8k
8	-16	-13	-8	-2	-7	-17	-26	-36	8	-14	-13	-8	-2	-7	-16	-25	-34
	-6	-9	-7	-7	-9	-13	-15	-19		-4	-9	-7	-7	-9	-12	-14	-17
16	-7	-6	-5	-8	-13	-17	-21	-26	16	-5	-6	-5	-8	-12	-17	-20	-25
	-4	-7	-6	-9	-13	-17	-20	-25		-3	-7	-6	-9	-13	-17	-19	-24
24-36	-5	-7	-7	-9	-11	-15	-19	-23	24-36	-4	-6	-7	-9	-10	-14	-17	-21
	-4	-7	-7	-9	-13	-18	-21	-27		-2	-7	-7	-9	-13	-17	-20	-25

SK11911

WAM_DC_00073GB_60HZ JM AEROFOIL
January 2024



FAN CODE: 56JM/20/6/6/...
560mm 1070 rev/min 6 Blades 60 Hz

Performance Data ISO 5801

Performance shown is for installations type D – Ducted inlet, Ducted outlet. Performance ratings do not include the effects of appurtenances.

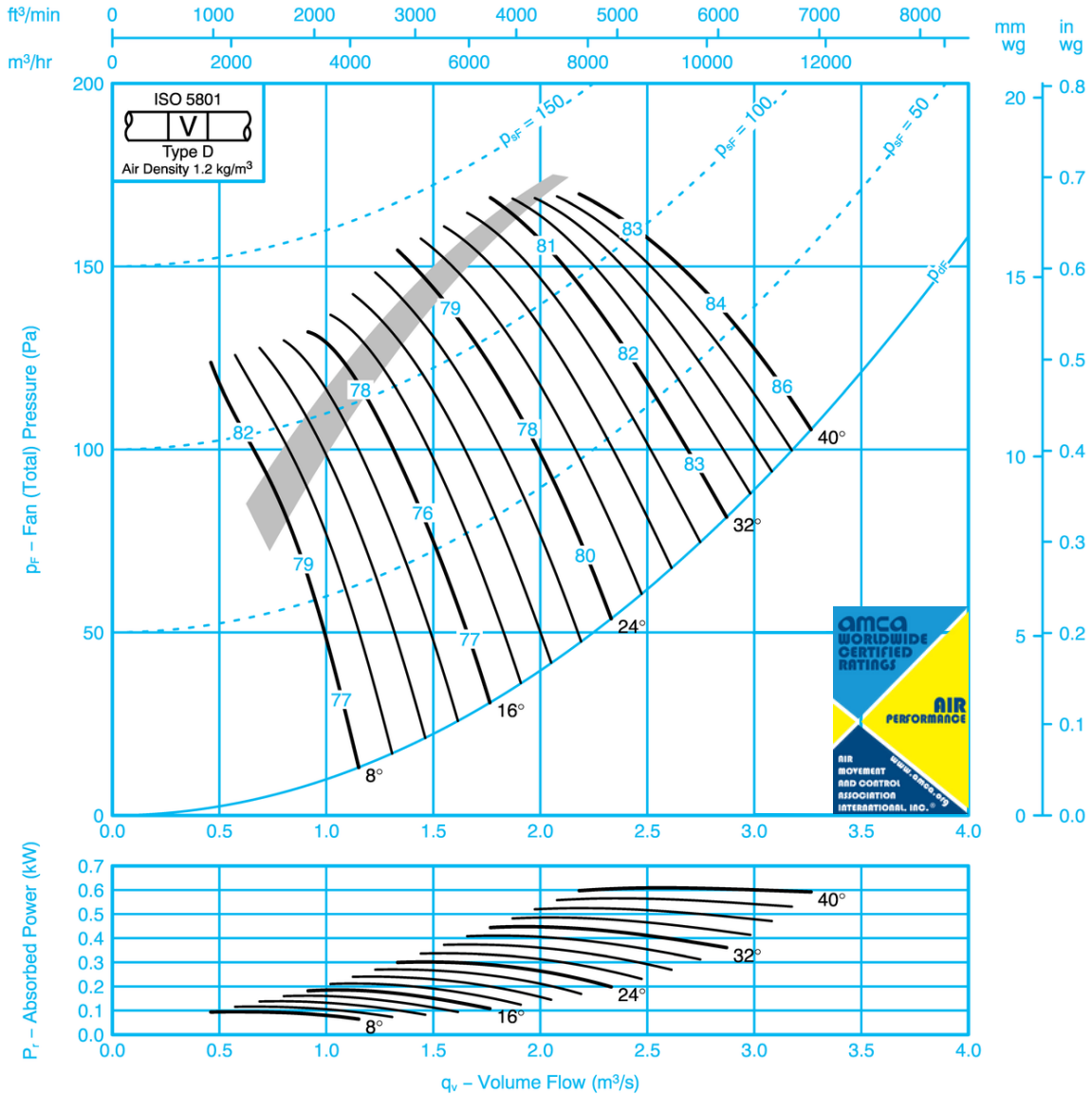

Sound Data ISO 5136

Single figures on performance curves are overall inlet sound power levels, derived from measurements taken in Woods laboratory specifically under ducted conditions. For sound power levels in eight octave bands, apply the following corrections to the overall level. Use upper corrections when operating point is above shaded area, or lower corrections when operating point is below shaded area.

Inlet Levels									Outlet Levels								
Pitch Angle	Octave Band Centre Frequency (Hz)								Pitch Angle	Octave Band Centre Frequency (Hz)							
	63	125	250	500	1k	2k	4k	8k		63	125	250	500	1k	2k	4k	8k
8	-23	-12	-11	-3	-6	-14	-25	-34	8	-21	-11	-12	-3	-6	-14	-24	-33
	-21	-10	-8	-4	-5	-12	-17	-22		-19	-8	-8	-4	-5	-11	-16	-21
16	-17	-6	-6	-5	-10	-15	-21	-27	16	-15	-5	-6	-5	-9	-14	-20	-27
	-14	-4	-7	-7	-10	-14	-17	-21		-12	-3	-7	-7	-10	-14	-16	-20
24-40	-7	-5	-8	-10	-12	-14	-18	-21	24-40	-5	-4	-8	-9	-11	-13	-16	-20
	-6	-5	-8	-10	-13	-16	-20	-24		-4	-3	-8	-10	-13	-16	-19	-23

SK11912

WAM_DC_00073GB_60HZ JM AEROFOIL
January 2024



FAN CODE: 56JM/16/4/5/...
560mm 1700 rev/min 5 Blades 60 Hz

Performance Data ISO 5801

Performance shown is for installations type D – Ducted inlet, Ducted outlet. Performance ratings do not include the effects of appurtenances.

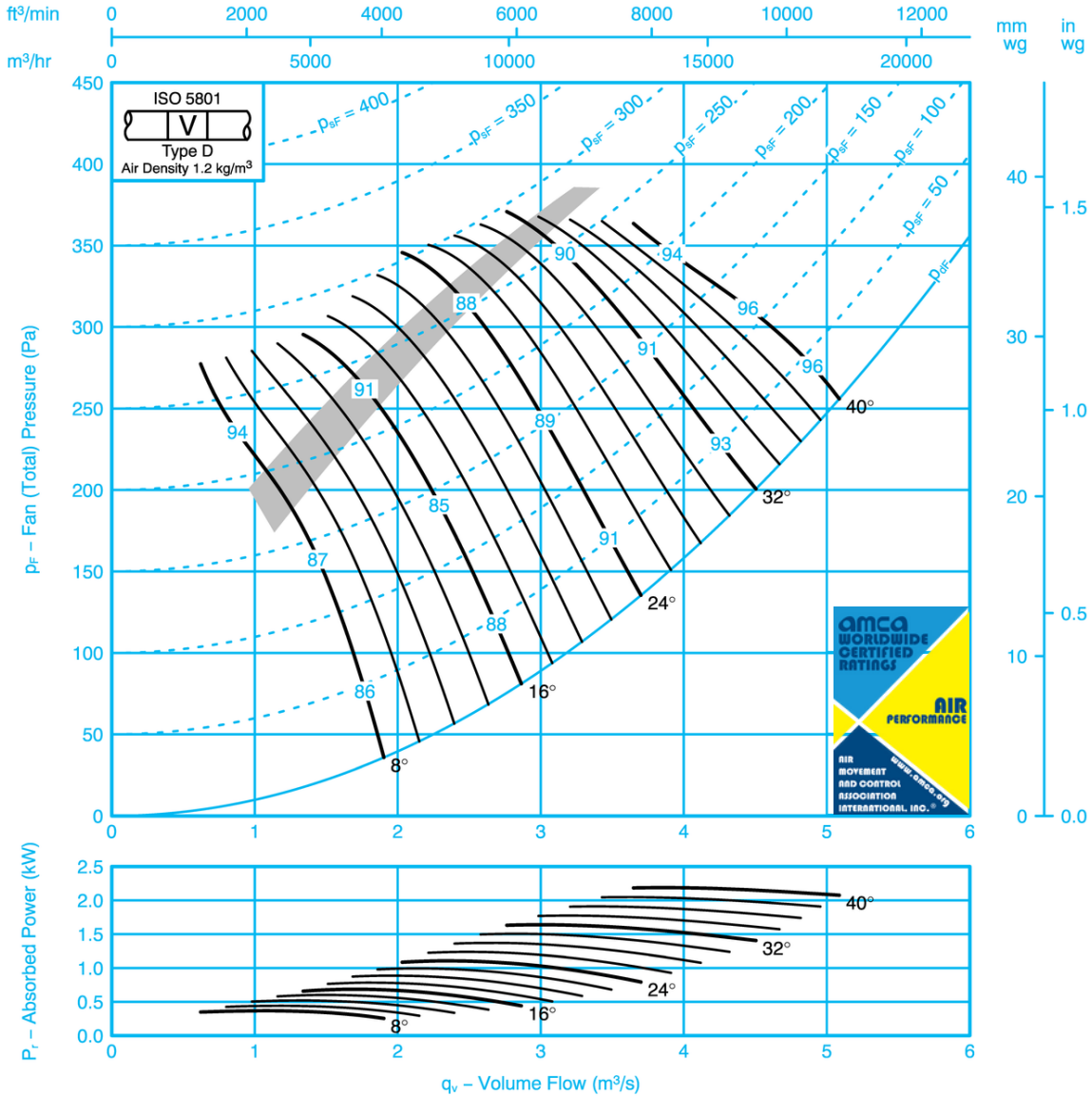

Sound Data ISO 5136

Single figures on performance curves are overall inlet sound power levels, derived from measurements taken in Woods laboratory specifically under ducted conditions. For sound power levels in eight octave bands, apply the following corrections to the overall level. Use upper corrections when operating point is above shaded area, or lower corrections when operating point is below shaded area.

Inlet Levels									Outlet Levels								
Pitch Angle	Octave Band Centre Frequency (Hz)								Pitch Angle	Octave Band Centre Frequency (Hz)							
	63	125	250	500	1k	2k	4k	8k		63	125	250	500	1k	2k	4k	8k
8	-19	-13	-12	-4	-5	-10	-18	-25	8	-18	-11	-12	-4	-5	-9	-17	-22
	-17	-8	-11	-8	-6	-7	-12	-17		-17	-8	-11	-8	-5	-6	-11	-16
16	-18	-12	-13	-4	-5	-9	-17	-24	16	-17	-12	-13	-4	-5	-9	-16	-22
	-12	-4	-8	-7	-10	-12	-15	-19		-12	-4	-8	-7	-10	-11	-14	-17
24-40	-7	-5	-10	-8	-10	-13	-16	-19	24-40	-6	-5	-10	-8	-10	-13	-15	-18
	-7	-4	-9	-9	-11	-14	-18	-22		-6	-3	-9	-9	-11	-14	-17	-20

SK11913

WAM_DC_00073GB_60HZ JM AEROFOIL
January 2024



FAN CODE: 56JM/20/4/3/...
560mm 1700 rev/min 3 Blades 60 Hz

Performance Data ISO 5801

Performance shown is for installations type D – Ducted inlet, Ducted outlet. Performance ratings do not include the effects of appurtenances.

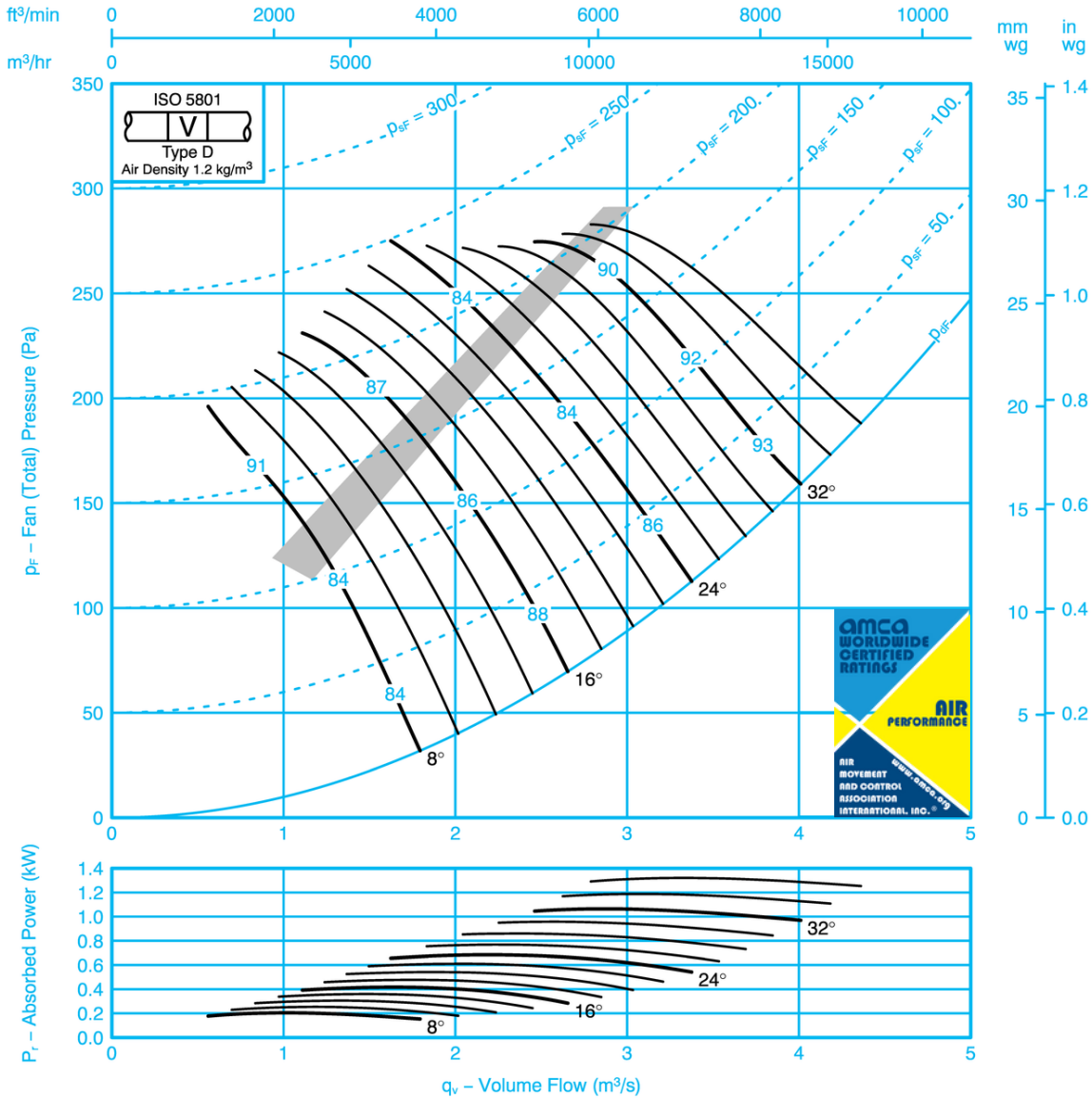

Sound Data ISO 5136

Single figures on performance curves are overall inlet sound power levels, derived from measurements taken in Woods laboratory specifically under ducted conditions. For sound power levels in eight octave bands, apply the following corrections to the overall level. Use upper corrections when operating point is above shaded area, or lower corrections when operating point is below shaded area.

Inlet Levels								Outlet Levels									
Pitch Angle	Octave Band Centre Frequency (Hz)								Pitch Angle	Octave Band Centre Frequency (Hz)							
	63	125	250	500	1k	2k	4k	8k		63	125	250	500	1k	2k	4k	8k
8	-21	-17	-11	-6	-3	-10	-20	-29	8	-19	-15	-11	-6	-3	-10	-19	-27
	-13	-7	-8	-7	-7	-10	-14	-17		-10	-5	-8	-7	-7	-10	-12	-14
16	-13	-7	-5	-5	-9	-15	-18	-22	16	-11	-6	-5	-5	-9	-14	-17	-21
	-10	-5	-7	-7	-10	-15	-18	-22		-8	-4	-7	-7	-10	-14	-18	-21
24-36	-9	-6	-6	-8	-9	-13	-17	-21	24-36	-7	-5	-6	-8	-9	-12	-15	-18
	-8	-5	-7	-8	-10	-15	-19	-23		-5	-3	-7	-8	-10	-14	-18	-21

SK11914

WAM_DC_00073GB_60HZ JM AEROFOIL
January 2024



FAN CODE: 56JM/20/4/6/...
560mm 1700 rev/min 6 Blades 60 Hz

Performance Data ISO 5801

Performance shown is for installations type D – Ducted inlet, Ducted outlet. Performance ratings do not include the effects of appurtenances.

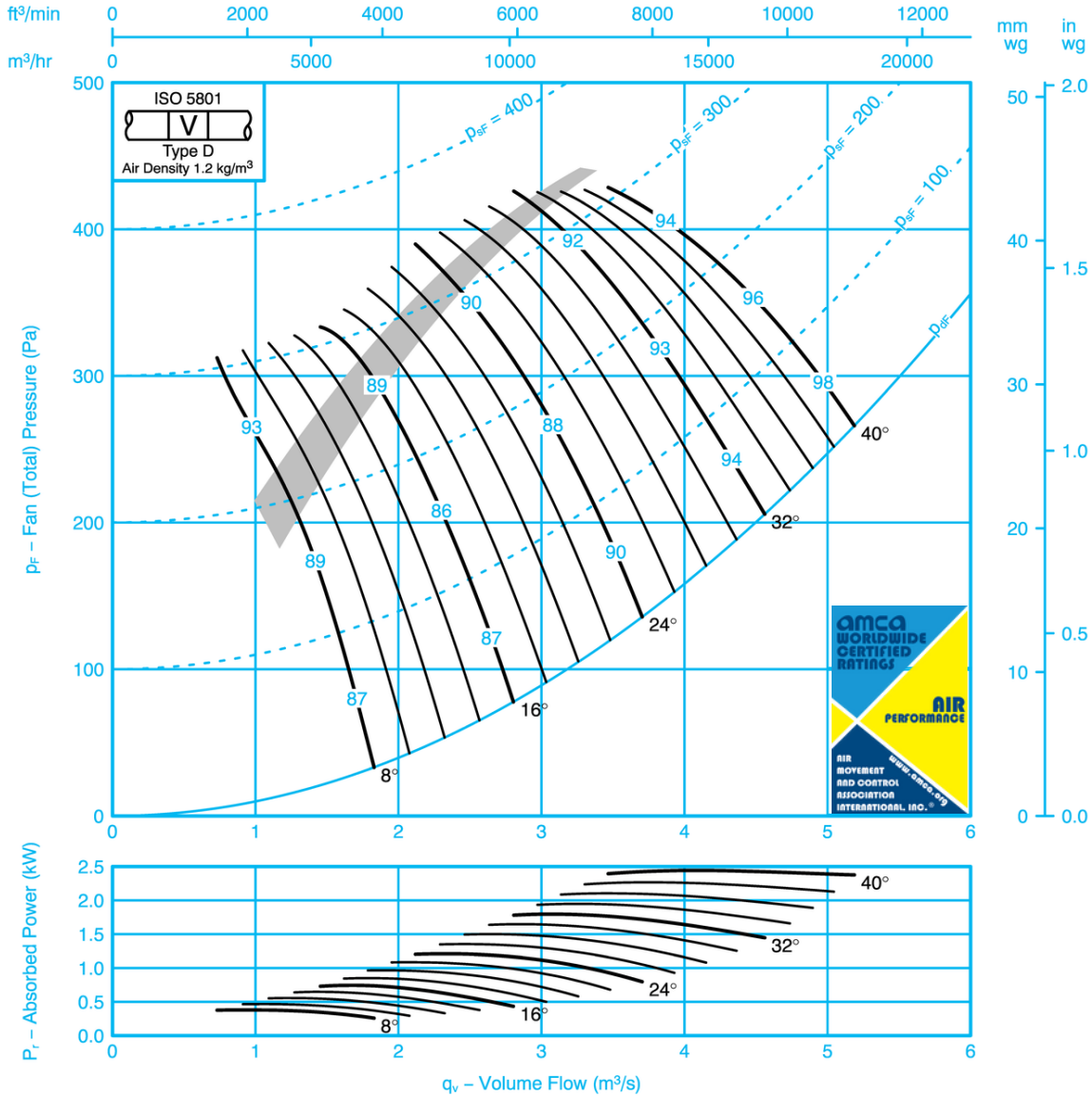

Sound Data ISO 5136

Single figures on performance curves are overall inlet sound power levels, derived from measurements taken in Woods laboratory specifically under ducted conditions. For sound power levels in eight octave bands, apply the following corrections to the overall level. Use upper corrections when operating point is above shaded area, or lower corrections when operating point is below shaded area.

Inlet Levels									Outlet Levels								
Pitch Angle	Octave Band Centre Frequency (Hz)								Pitch Angle	Octave Band Centre Frequency (Hz)							
	63	125	250	500	1k	2k	4k	8k		63	125	250	500	1k	2k	4k	8k
8	-24	-22	-12	-9	-2	-8	-18	-28	8	-22	-20	-11	-9	-2	-7	-17	-26
	-20	-19	-9	-7	-4	-8	-14	-19		-18	-17	-8	-7	-4	-7	-13	-17
16	-16	-14	-6	-5	-6	-11	-16	-23	16	-15	-13	-5	-5	-5	-10	-16	-22
	-12	-12	-5	-7	-7	-11	-15	-18		-10	-10	-4	-7	-7	-11	-15	-17
24-40	-7	-7	-7	-9	-11	-13	-16	-20	24-40	-5	-6	-6	-8	-10	-12	-15	-18
	-6	-7	-7	-9	-12	-15	-18	-22		-4	-5	-5	-9	-12	-14	-17	-21

SK11915

WAM_DC_00073GB_60HZ JM AEROFOIL
January 2024



FAN CODE: 56JM/20/2/3/...
560mm 3500 rev/min 3 Blades 60 Hz

Performance Data ISO 5801

Performances shown is for installations type D – Ducted inlet, Ducted outlet. Performance ratings do not include the effects of appurtenances.

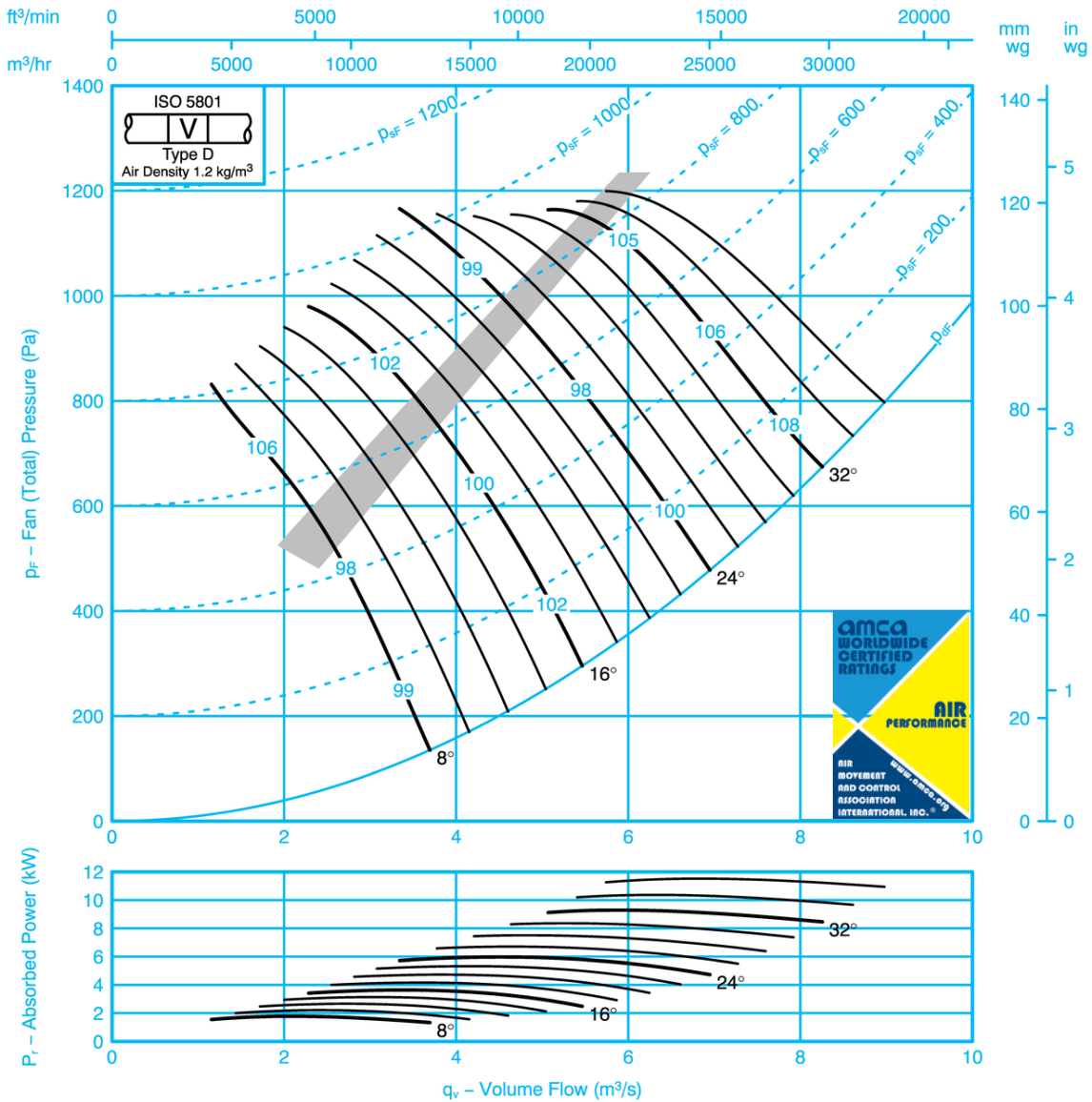

If it is intended to run this fan in reverse for other than emergency operation, please refer to Woods Air Movement.

Sound Data ISO 5136

Single figures on performance curves are overall inlet sound power levels, derived from measurements taken in Woods laboratory specifically under ducted conditions. For sound power levels in eight octave bands, apply the following corrections to the overall level. Use upper corrections when operating point is above shaded area, or lower corrections when operating point is below shaded area.

Inlet Levels								Outlet Levels												
Pitch Angle	Octave Band Centre Frequency (Hz)							Pitch Angle	Octave Band Centre Frequency (Hz)											
	63	125	250	500	1k	2k	4k		8k	63	125	250	500	1k	2k	4k	8k			
8	-22	-14	-13	-17	-6	-8	-3	-11	-20	8	-20	-13	-19	-10	-4	-8	-5	-2	-10	-18
16	-13	-13	-10	-7	-6	-8	-10	-16	-18	16	-11	-9	-11	-9	-3	-7	-5	-8	-15	-17
24-36	-10	-9	-9	-6	-7	-9	-10	-14	-17	24-36	-9	-7	-7	-7	-3	-6	-8	-9	-12	-15

SK11916

WAM_DC_00073GB_60HZ JM AEROFOIL
January 2024



FAN CODE: 56JM/20/2/6/...
560mm 3500 rev/min 6 Blades 60 Hz

Performance Data ISO 5801

Performance shown is for installations type D – Ducted inlet, Ducted outlet. Performance ratings do not include the effects of appurtenances.

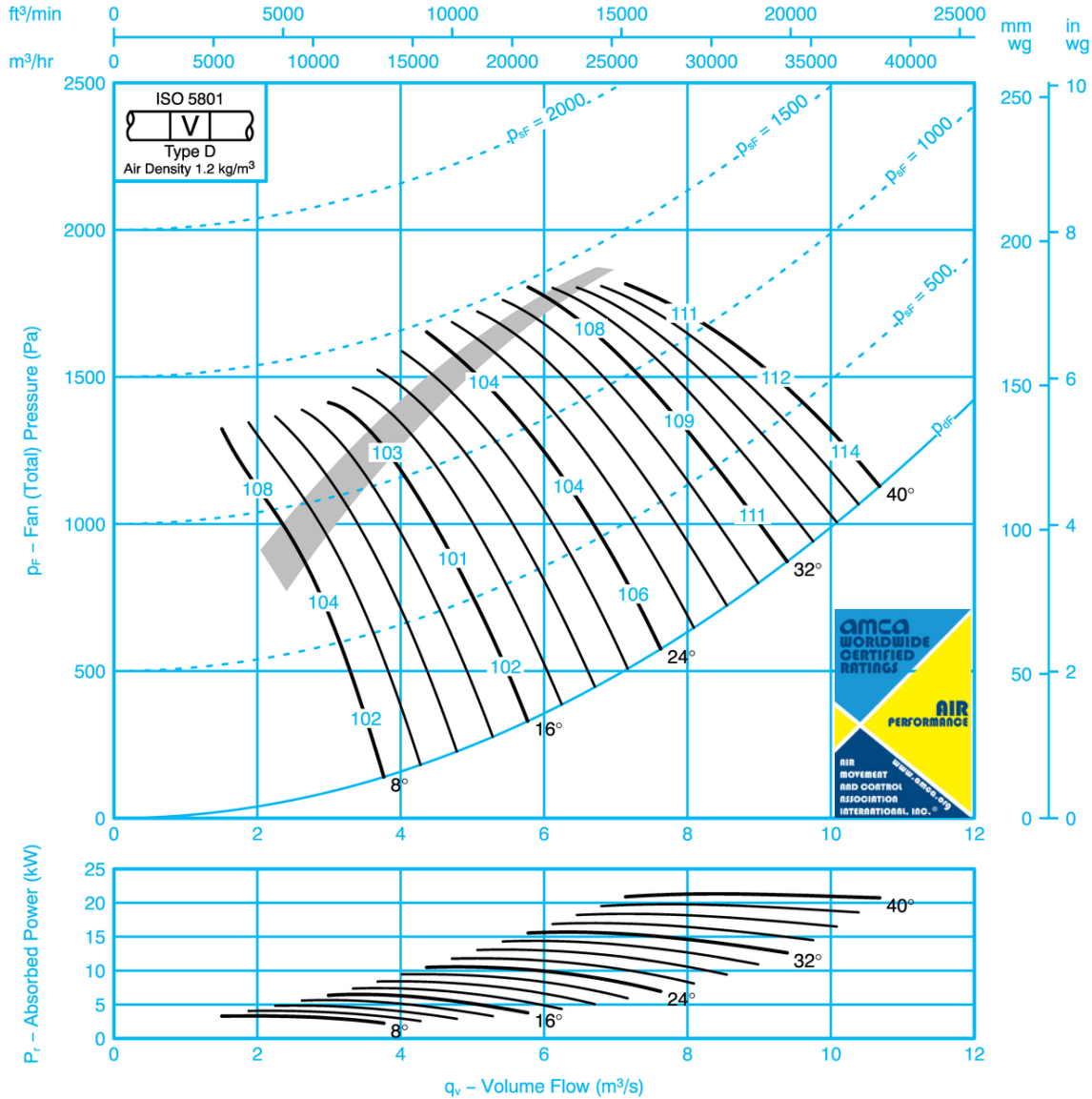

If it is intended to run this fan in reverse for other than emergency operation, please refer to Woods Air Movement.

Sound Data ISO 5136

Single figures on performance curves are overall inlet sound power levels, derived from measurements taken in Woods laboratory specifically under ducted conditions. For sound power levels in eight octave bands, apply the following corrections to the overall level. Use upper corrections when operating point is above shaded area, or lower corrections when operating point is below shaded area.

Inlet Levels									Outlet Levels								
Pitch Angle	Octave Band Centre Frequency (Hz)								Pitch Angle	Octave Band Centre Frequency (Hz)							
	63	125	250	500	1k	2k	4k	8k		63	125	250	500	1k	2k	4k	8k
8	-20	-24	-22	-11	-8	-2	-9	-18	8	-17	-24	-21	-9	-8	-2	-8	-17
	-15	-20	-19	-9	-8	-4	-8	-14		-13	-20	-17	-7	-8	-3	-7	-12
16	-11	-17	-15	-5	-6	-6	-12	-17	16	-9	-17	-13	-5	-6	-6	-12	-16
	-8	-13	-13	-5	-8	-8	-13	-16		-7	-13	-11	-3	-8	-8	-12	-15
24-40	-8	-8	-8	-7	-10	-12	-14	-17	24-40	-7	-7	-7	-6	-9	-11	-13	-15
	-7	-7	-8	-8	-10	-13	-16	-19		-5	-7	-6	-6	-10	-12	-15	-18

SK11917

WAM_DC_00073GB_60HZ JM AEROFOIL
January 2024



FAN CODE: 63JM/20/8/3/...
630mm 800 rev/min 3 Blades 60 Hz

Performance Data ISO 5801

Performance shown is for installations type D – Ducted inlet, Ducted outlet. Performance ratings do not include the effects of appurtenances.

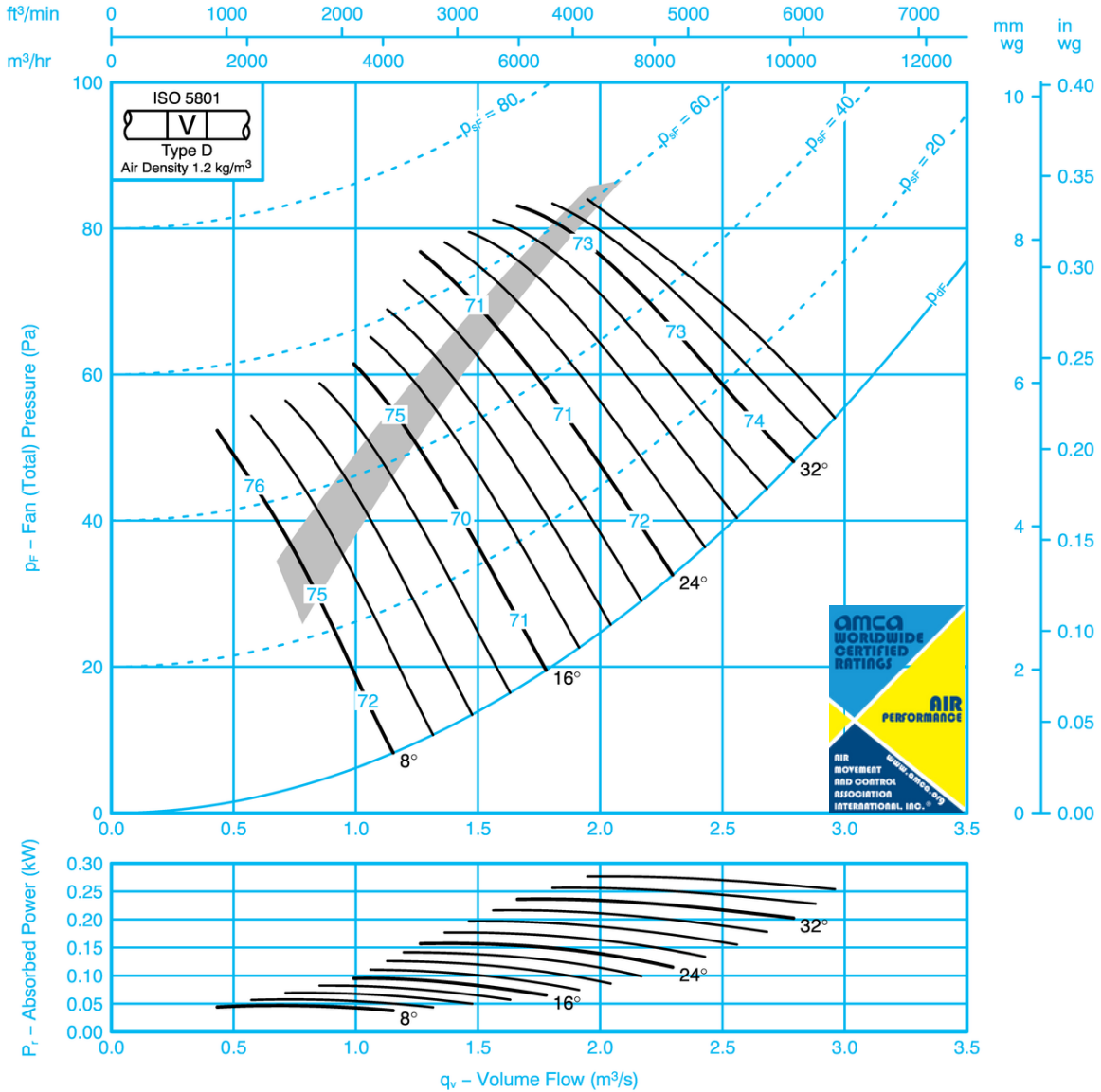

Sound Data ISO 5136

Single figures on performance curves are overall inlet sound power levels, derived from measurements taken in Woods laboratory specifically under ducted conditions. For sound power levels in eight octave bands, apply the following corrections to the overall level. Use upper corrections when operating point is above shaded area, or lower corrections when operating point is below shaded area.

Inlet Levels								Outlet Levels									
Pitch Angle	Octave Band Centre Frequency (Hz)								Pitch Angle	Octave Band Centre Frequency (Hz)							
	63	125	250	500	1k	2k	4k	8k		63	125	250	500	1k	2k	4k	8k
8	-8	-9	-4	-6	-12	-18	-25	-34	8	-6	-9	-4	-6	-12	-18	-24	-31
	-3	-9	-8	-9	-12	-15	-20	-28		-2	-9	-8	-9	-12	-13	-19	-26
16	-6	-8	-4	-8	-14	-18	-26	-34	16	-5	-8	-4	-8	-14	-18	-25	-31
	-1	-9	-11	-16	-17	-19	-24	-30		-1	-9	-11	-16	-17	-18	-23	-28
24-36	-2	-8	-10	-13	-15	-19	-22	-28	24-36	-1	-8	-10	-13	-15	-19	-20	-26
	-1	-8	-12	-16	-19	-22	-25	-30		0	-8	-12	-16	-19	-21	-24	-28

SK11918

WAM_DC_00073GB_60HZ JM AEROFOIL
January 2024



FAN CODE: 63JM/20/8/6/...
630mm 800 rev/min 6 Blades 60 Hz

Performance Data ISO 5801

Performance shown is for installations type D – Ducted inlet, Ducted outlet. Performance ratings do not include the effects of appurtenances.

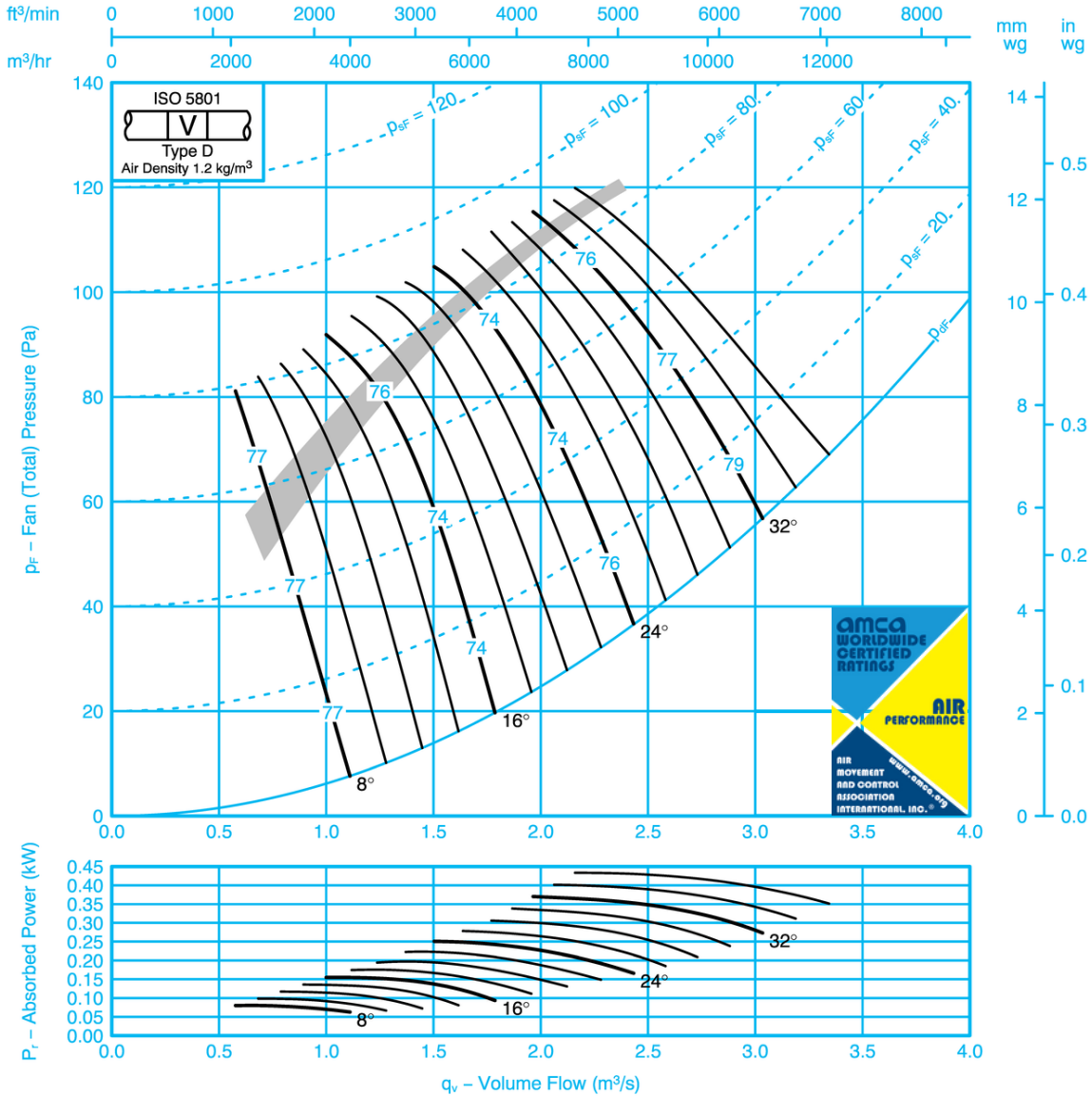

Sound Data ISO 5136

Single figures on performance curves are overall inlet sound power levels, derived from measurements taken in Woods laboratory specifically under ducted conditions. For sound power levels in eight octave bands, apply the following corrections to the overall level. Use upper corrections when operating point is above shaded area, or lower corrections when operating point is below shaded area.

Inlet Levels								Outlet Levels									
Pitch Angle	Octave Band Centre Frequency (Hz)							Pitch Angle	Octave Band Centre Frequency (Hz)								
	63	125	250	500	1k	2k	4k		8k	63	125	250	500	1k	2k	4k	8k
8	-7	-6	-4	-10	-13	-21	-28	-40	8	-6	-6	-4	-10	-14	-21	-28	-38
	-10	-7	-4	-7	-10	-18	-26	-38		-9	-7	-4	-7	-14	-21	-25	-37
16	-7	-6	-5	-9	-9	-13	-24	-38	16	-7	-6	-5	-9	-9	-13	-23	-36
	-5	-5	-9	-11	-10	-13	-22	-32		-4	-5	-9	-11	-10	-13	-21	-31
24-36	-5	-4	-7	-11	-14	-17	-21	-27	24-36	-5	-4	-7	-11	-14	-17	-21	-26
	-5	-4	-9	-12	-15	-18	-23	-29		-4	-4	-9	-12	-15	-18	-22	-27

SK11919

WAM_DC_00073GB_60HZ JM AEROFOIL
January 2024



Performance Data ISO 5801

Performance shown is for installations type D – Ducted inlet, Ducted outlet. Performance ratings do not include the effects of appurtenances.

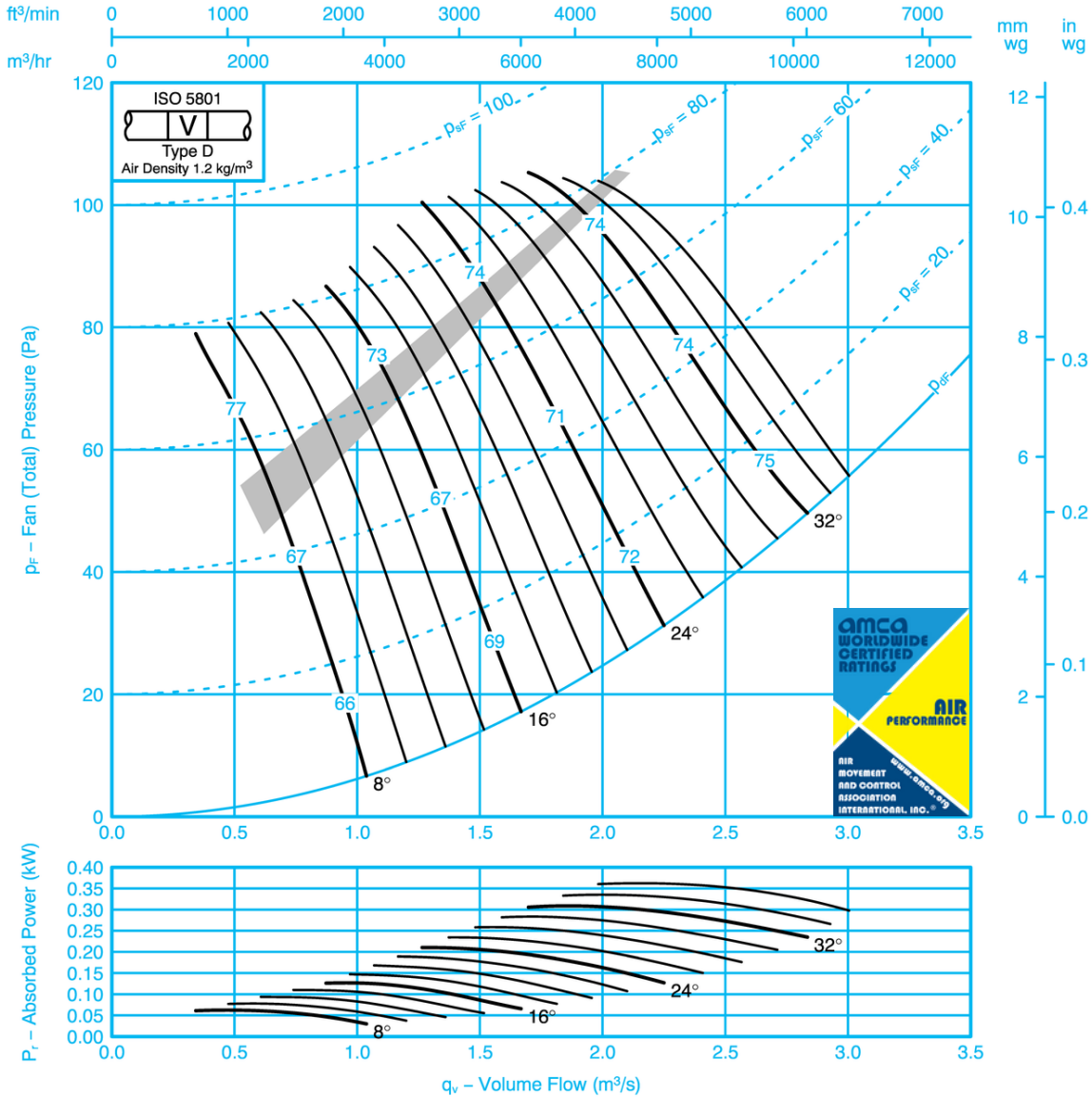

Sound Data ISO 5136

Single figures on performance curves are overall inlet sound power levels, derived from measurements taken in Woods laboratory specifically under ducted conditions. For sound power levels in eight octave bands, apply the following corrections to the overall level. Use upper corrections when operating point is above shaded area, or lower corrections when operating point is below shaded area.

Inlet Levels								Outlet Levels									
Pitch Angle	Octave Band Centre Frequency (Hz)							Pitch Angle	Octave Band Centre Frequency (Hz)								
	63	125	250	500	1k	2k	4k		8k	63	125	250	500	1k	2k	4k	8k
8	-10	-9	-6	-5	-8	-15	-23	-35	8	-8	-8	-6	-5	-8	-15	-23	-33
	-5	-7	-8	-10	-10	-10	-16	-25		-4	-6	-8	-10	-10	-9	-15	-23
16	-6	-6	-6	-10	-10	-12	-20	-28	16	-5	-6	-6	-10	-9	-12	-19	-27
	-4	-6	-8	-12	-12	-13	-19	-28		-2	-5	-8	-12	-12	-13	-19	-28
24-36	-5	-6	-6	-10	-12	-16	-21	-26	24-36	-3	-5	-6	-10	-12	-15	-19	-25
	-3	-7	-8	-12	-14	-17	-23	-30		-1	-6	-8	-12	-14	-17	-22	-29



Performance Data ISO 5801

Performance shown is for installations type D – Ducted inlet, Ducted outlet. Performance ratings do not include the effects of appurtenances.

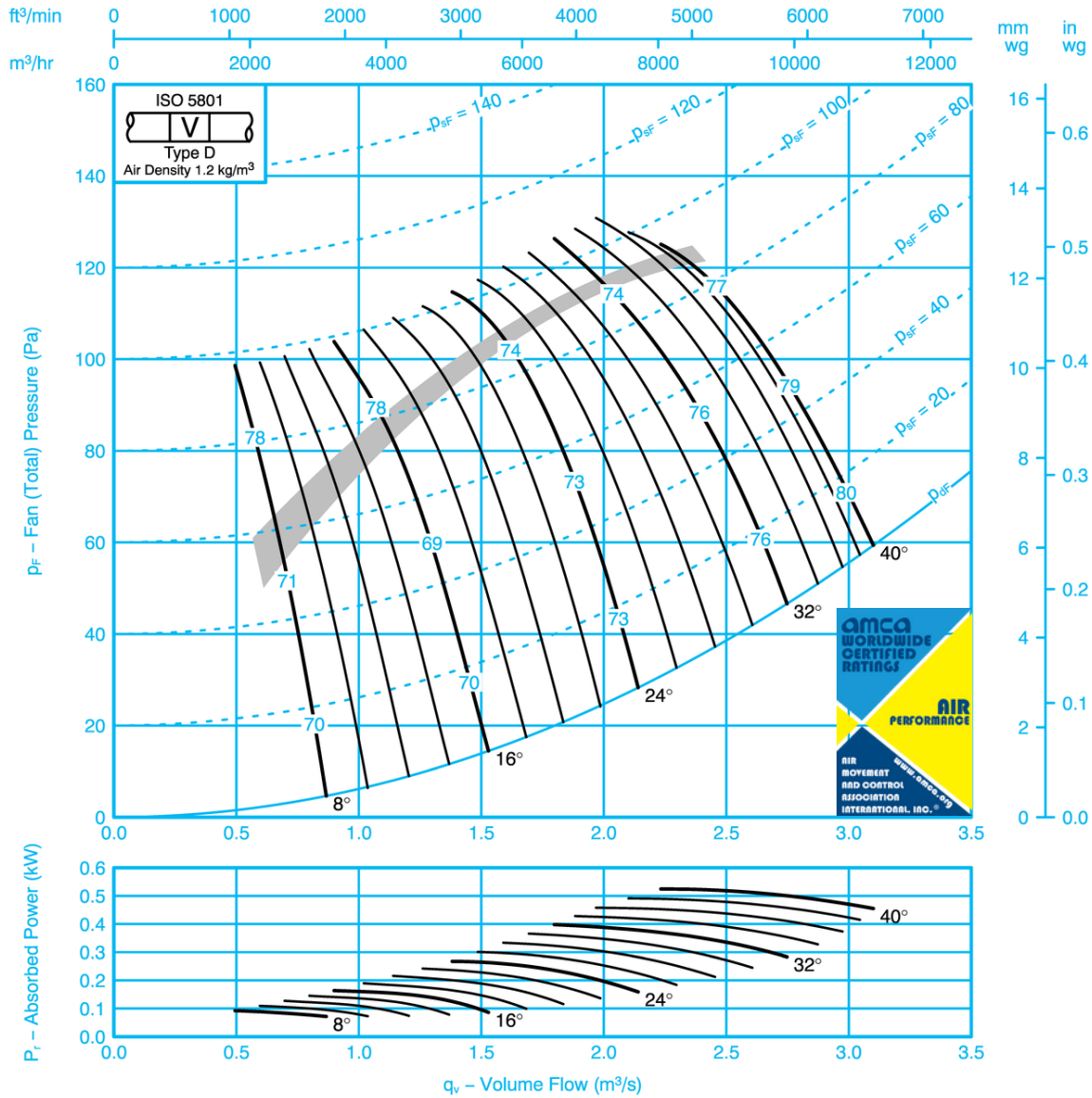

Sound Data ISO 5136

Single figures on performance curves are overall inlet sound power levels, derived from measurements taken in Woods laboratory specifically under ducted conditions. For sound power levels in eight octave bands, apply the following corrections to the overall level. Use upper corrections when operating point is above shaded area, or lower corrections when operating point is below shaded area.

Inlet Levels								Outlet Levels									
Pitch Angle	Octave Band Centre Frequency (Hz)								Pitch Angle	Octave Band Centre Frequency (Hz)							
	63	125	250	500	1k	2k	4k	8k		63	125	250	500	1k	2k	4k	8k
8	-11	-8	-8	-5	-7	-14	-23	-34	8	-9	-6	-8	-5	-7	-13	-22	-33
	-10	-9	-8	-6	-7	-8	-15	-26		-9	-7	-8	-6	-7	-14	-24	-34
16	-11	-6	-7	-5	-9	-14	-21	-32	16	-10	-4	-7	-5	-8	-13	-21	-31
	-9	-4	-7	-10	-11	-11	-17	-27		-7	-2	-7	-10	-11	-17	-27	-31
24-40	-6	-4	-7	-11	-13	-16	-20	-25	24-40	-5	-3	-6	-11	-13	-15	-19	-24
	-5	-5	-7	-12	-14	-17	-23	-30		-2	-3	-7	-12	-14	-17	-22	-29



FAN CODE: 63JM/20/6/3/...
630mm 1070 rev/min 3 Blades 60 Hz

Performance Data ISO 5801

Performances shown is for installations type D – Ducted inlet, Ducted outlet. Performance ratings do not include the effects of appurtenances.

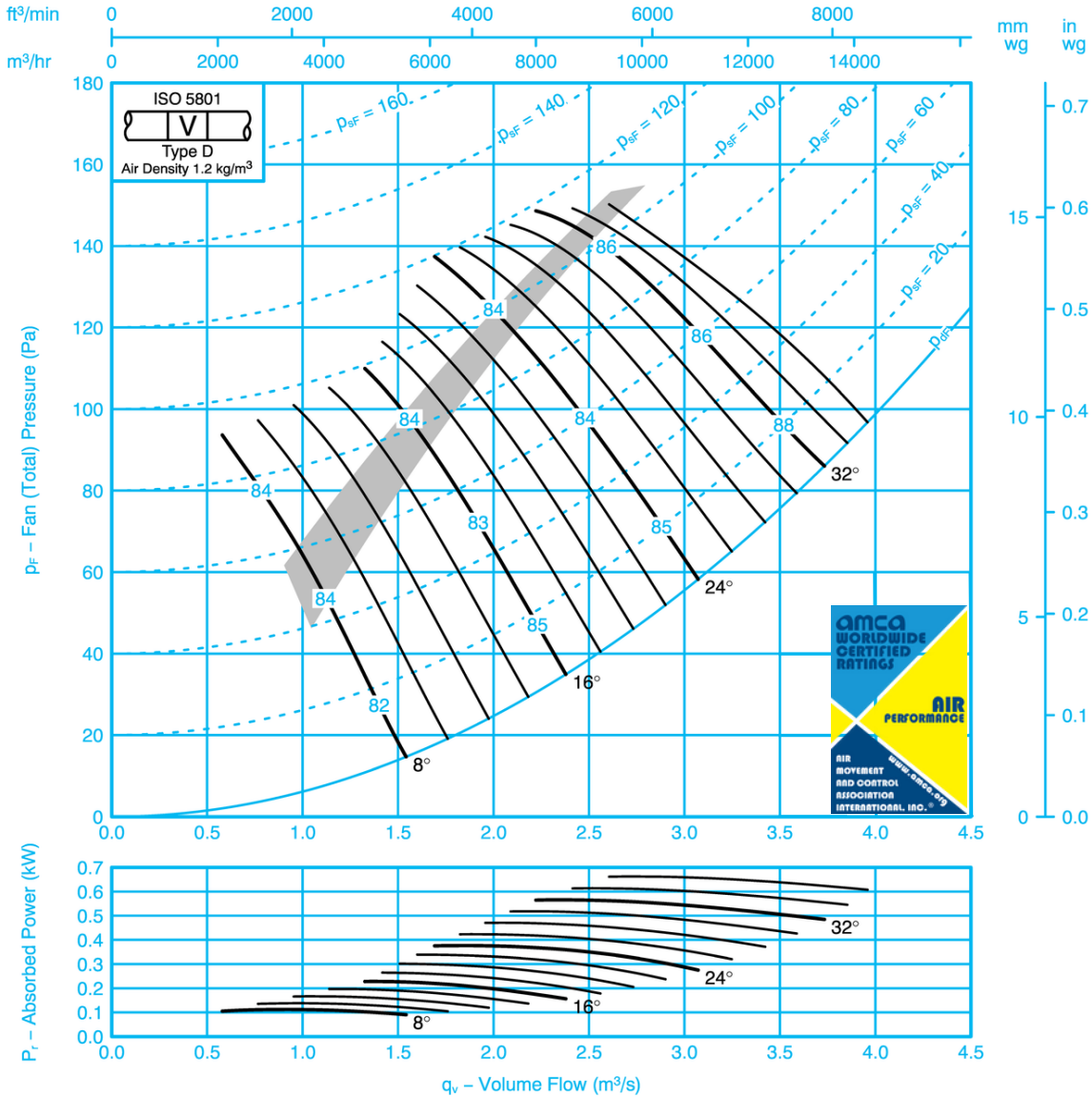

Sound Data ISO 5136

Single figures on performance curves are overall inlet sound power levels, derived from measurements taken in Woods laboratory specifically under ducted conditions. For sound power levels in eight octave bands, apply the following corrections to the overall level. Use upper corrections when operating point is above shaded area, or lower corrections when operating point is below shaded area.

Inlet Levels								Outlet Levels									
Pitch Angle	Octave Band Centre Frequency (Hz)							Pitch Angle	Octave Band Centre Frequency (Hz)								
	63	125	250	500	1k	2k	4k		8k	63	125	250	500	1k	2k	4k	8k
8	-7	-11	-5	-5	-11	-16	-23	-31	8	-5	-11	-5	-5	-11	-16	-22	-28
	-2	-12	-8	-10	-13	-14	-19	-26		-1	-12	-8	-10	-13	-13	-18	-24
16	-5	-11	-4	-7	-13	-16	-25	-31	16	-4	-11	-4	-7	-13	-16	-23	-28
	-1	-11	-11	-16	-19	-19	-24	-29		0	-11	-11	-16	-19	-18	-22	-27
24-36	-2	-9	-9	-14	-16	-19	-21	-26	24-36	-1	-9	-9	-14	-16	-19	-20	-25
	-1	-9	-11	-16	-20	-22	-26	-30		0	-9	-11	-16	-20	-22	-24	-27

SK11924

WAM_DC_00073GB_60HZ JM AEROFOIL
January 2024



FAN CODE: 63JM/20/6/6/...
630mm 1070 rev/min 6 Blades 60 Hz

Performance Data ISO 5801

Performance shown is for installations type D – Ducted inlet, Ducted outlet. Performance ratings do not include the effects of appurtenances.

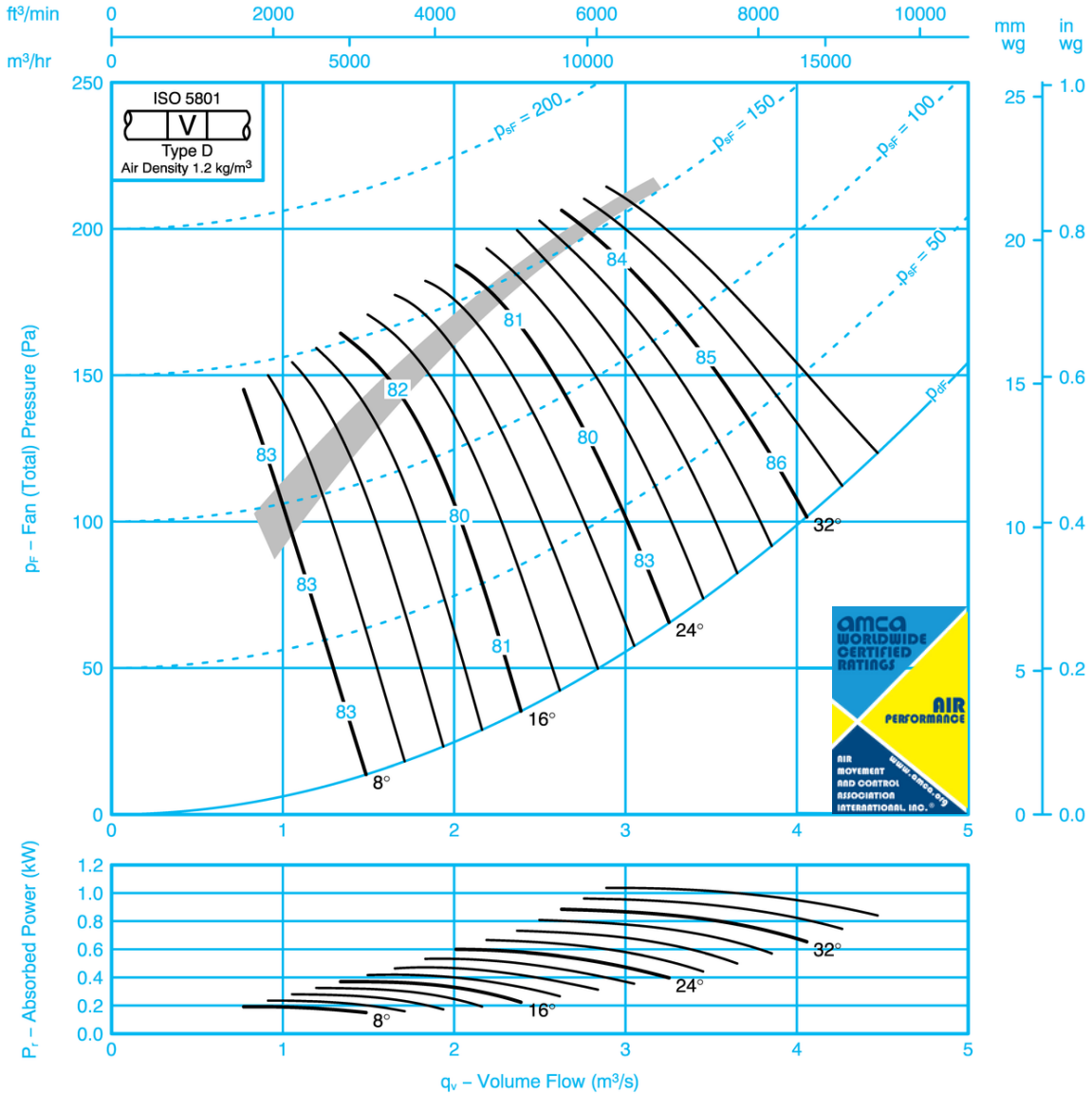

Sound Data ISO 5136

Single figures on performance curves are overall inlet sound power levels, derived from measurements taken in Woods laboratory specifically under ducted conditions. For sound power levels in eight octave bands, apply the following corrections to the overall level. Use upper corrections when operating point is above shaded area, or lower corrections when operating point is below shaded area.

Inlet Levels								Outlet Levels									
Pitch Angle	Octave Band Centre Frequency (Hz)								Pitch Angle	Octave Band Centre Frequency (Hz)							
	63	125	250	500	1k	2k	4k	8k		63	125	250	500	1k	2k	4k	8k
8	-8	-7	-4	-9	-13	-20	-26	-36	8	-7	-6	-3	-9	-13	-20	-26	-34
	-12	-9	-5	-5	-10	-17	-23	-33		-12	-8	-5	-5	-10	-16	-23	-32
16	-11	-6	-6	-7	-9	-11	-23	-33	16	-10	-6	-6	-7	-9	-11	-22	-32
	-8	-4	-8	-10	-10	-11	-20	-28		-8	-4	-8	-10	-10	-11	-20	-27
24-36	-8	-3	-7	-10	-14	-16	-20	-25	24-36	-7	-3	-7	-10	-14	-16	-19	-23
	-6	-4	-8	-12	-15	-17	-22	-27		-5	-3	-8	-12	-15	-17	-21	-25

SK11925

WAM_DC_00073GB_60HZ JM AEROFOIL
January 2024



FAN CODE: 63JM/25/6/6/...
630mm 1110 rev/min 6 Blades 60 Hz

Performance Data ISO 5801

Performances shown is for installation type D – Ducted inlet, Ducted outlet. Performance ratings do not include the effects of appurtenances.

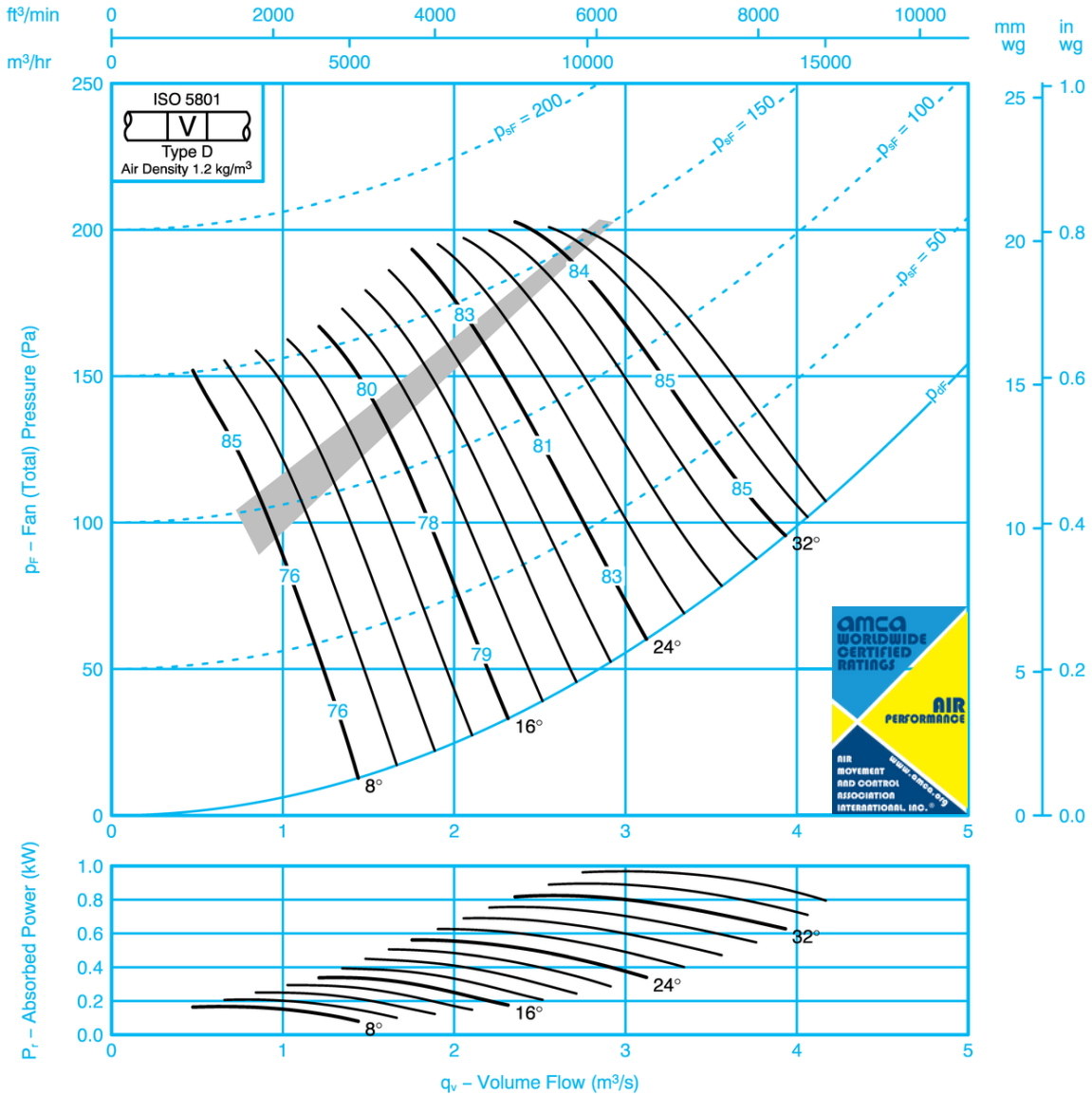

Sound Data ISO 5136

Single figures on performance curves are overall inlet sound power levels, derived from measurements taken in Woods laboratory specifically under ducted conditions. For sound power levels in eight octave bands, apply the following corrections to the overall level. Use upper corrections when operating point is above shaded area, or lower corrections when operating point is below shaded area.

Inlet Levels									Outlet Levels								
Pitch Angle	Octave Band Centre Frequency (Hz)								Pitch Angle	Octave Band Centre Frequency (Hz)							
	63	125	250	500	1k	2k	4k	8k		63	125	250	500	1k	2k	4k	8k
8	-10	-10	-7	-5	-7	-14	-22	-30	8	-8	-8	-7	-5	-7	-14	-21	-29
	-5	-7	-8	-10	-10	-10	-14	-23		-4	-6	-8	-10	-10	-9	-13	-21
16	-6	-7	-6	-10	-10	-12	-18	-24	16	-5	-6	-6	-10	-9	-11	-18	-24
	-3	-7	-8	-12	-12	-14	-18	-26		-2	-6	-8	-12	-12	-14	-18	-25
24-36	-5	-7	-6	-10	-12	-16	-21	-23	24-36	-3	-6	-6	-10	-12	-15	-19	-22
	-3	-8	-8	-12	-14	-17	-23	-27		0	-6	-8	-12	-14	-17	-22	-26

SK11927

WAM_DC_00073GB_60HZ JM AEROFOIL
January 2024



Performance Data ISO 5801

Performances shown is for installations type D – Ducted inlet, Ducted outlet. Performance ratings do not include the effects of appurtenances.

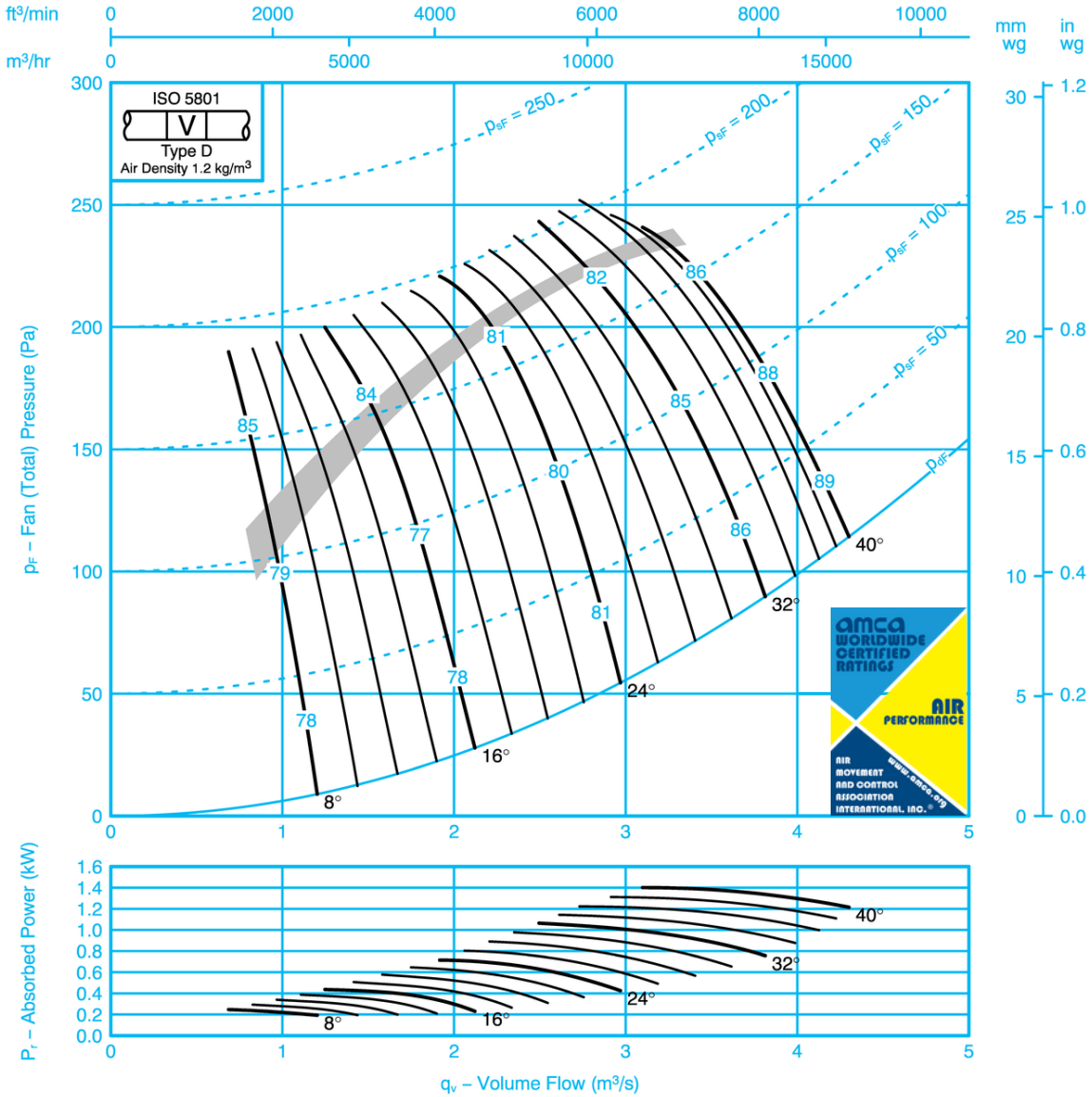

Sound Data ISO 5136

Single figures on performance curves are overall inlet sound power levels, derived from measurements taken in Woods laboratory specifically under ducted conditions. For sound power levels in eight octave bands, apply the following corrections to the overall level. Use upper corrections when operating point is above shaded area, or lower corrections when operating point is below shaded area.

Inlet Levels									Outlet Levels								
Pitch Angle	Octave Band Centre Frequency (Hz)								Pitch Angle	Octave Band Centre Frequency (Hz)							
	63	125	250	500	1k	2k	4k	8k		63	125	250	500	1k	2k	4k	8k
8	-12	-9	-9	-5	-5	-13	-21	-29	8	-10	-7	-8	-5	-5	-12	-20	-28
	-11	-10	-8	-7	-6	-8	-13	-22		-10	-8	-7	-7	-6	-7	-12	-21
16	-12	-7	-8	-5	-8	-13	-20	-27	16	-10	-5	-7	-5	-8	-12	-19	-26
	-9	-6	-6	-9	-11	-11	-15	-24		-7	-4	-5	-9	-11	-11	-15	-23
24-40	-6	-5	-6	-10	-13	-15	-20	-22	24-40	-5	-3	-6	-10	-12	-14	-18	-21
	-4	-6	-7	-11	-14	-17	-22	-27		-2	-4	-6	-11	-14	-17	-21	-26



FAN CODE: 63JM/20/4/3/...
630mm 1730 rev/min 3 Blades 60 Hz

Performance Data ISO 5801

Performances shown is for installations type D – Ducted inlet, Ducted outlet. Performance ratings do not include the effects of appurtenances.

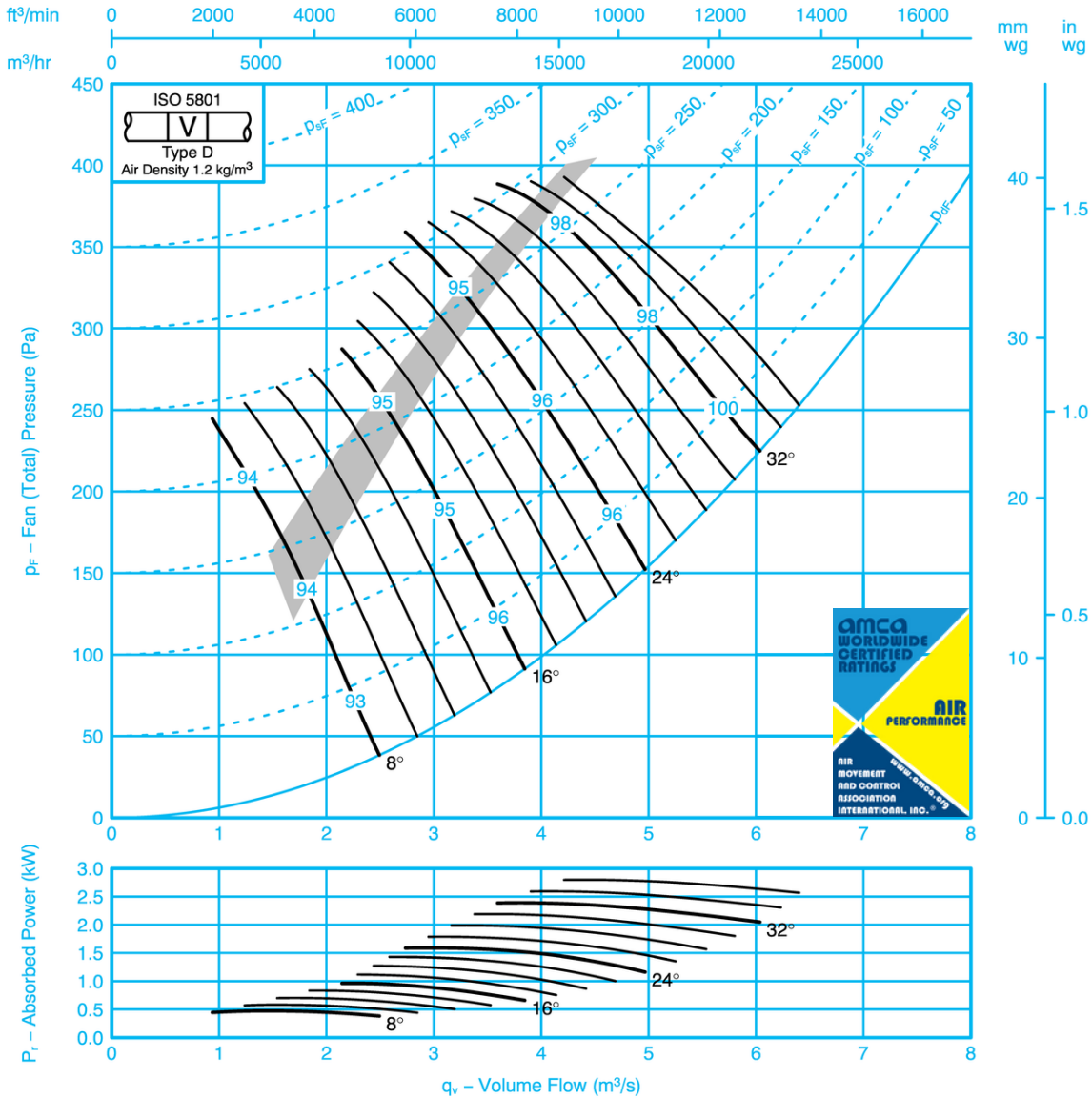

If it is intended to run this fan in reverse for other than emergency operation, please refer to Woods Air Movement.

Sound Data ISO 5136

Single figures on performance curves are overall inlet sound power levels, derived from measurements taken in Woods laboratory specifically under ducted conditions. For sound power levels in eight octave bands, apply the following corrections to the overall level. Use upper corrections when operating point is above shaded area, or lower corrections when operating point is below shaded area.

Inlet Levels								Outlet Levels									
Pitch Angle	Octave Band Centre Frequency (Hz)								Pitch Angle	Octave Band Centre Frequency (Hz)							
	63	125	250	500	1k	2k	4k	8k		63	125	250	500	1k	2k	4k	8k
8	-8	-9	-9	-5	-8	-13	-21	-26	8	-6	-8	-9	-5	-7	-12	-17	-23
	-4	-6	-11	-10	-12	-14	-18	-22		-3	-5	-10	-11	-10	-12	-13	-17
16	-7	-8	-8	-5	-11	-15	-21	-28	16	-6	-8	-8	-5	-10	-15	-19	-25
	-3	-5	-12	-15	-19	-20	-23	-27		-2	-4	-12	-15	-19	-19	-21	-25
24-36	-4	-5	-10	-13	-16	-18	-22	-24	24-36	-2	-4	-10	-13	-16	-18	-20	-22
	-3	-5	-11	-15	-19	-22	-25	-28		-2	-4	-11	-15	-19	-21	-24	-26

SK11929

WAM_DC_00073GB_60HZ JM AEROFOIL
January 2024



FAN CODE: 63JM/20/4/6/...
630mm 1730 rev/min 6 Blades 60 Hz

Performance Data ISO 5801

Performances shown is for installations type D – Ducted inlet, Ducted outlet. Performance ratings do not include the effects of appurtenances.

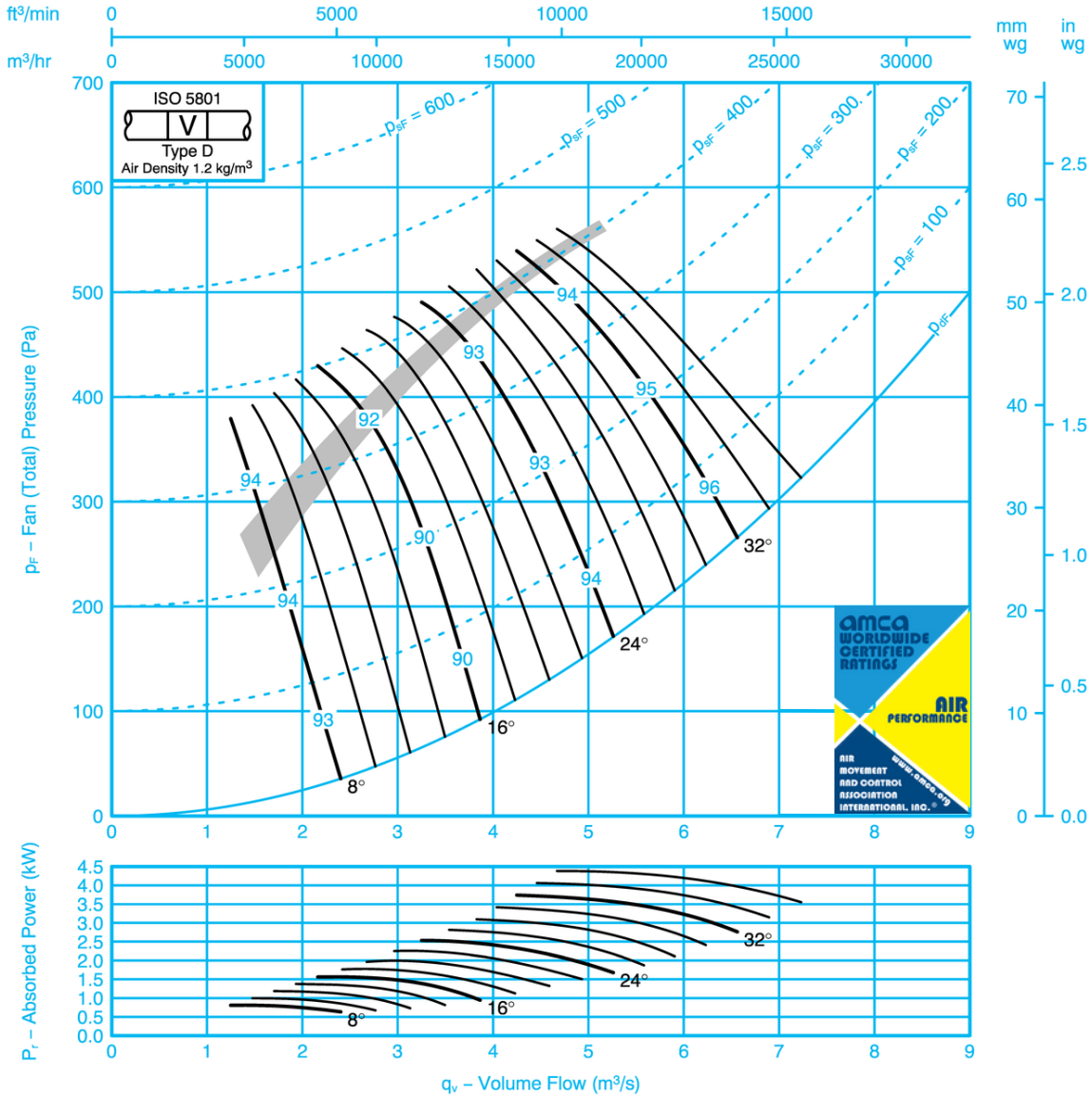

If it is intended to run this fan in reverse for other than emergency operation, please refer to Woods Air Movement.

Sound Data ISO 5136

Single figures on performance curves are overall inlet sound power levels, derived from measurements taken in Woods laboratory specifically under ducted conditions. For sound power levels in eight octave bands, apply the following corrections to the overall level. Use upper corrections when operating point is above shaded area, or lower corrections when operating point is below shaded area.

Inlet Levels								Outlet Levels									
Pitch Angle	Octave Band Centre Frequency (Hz)							Pitch Angle	Octave Band Centre Frequency (Hz)								
	63	125	250	500	1k	2k	4k		8k	63	125	250	500	1k	2k	4k	8k
8	-12	-8	-7	-4	-11	-15	-22	-30	8	-10	-6	-6	-4	-11	-8	-14	-22
	-14	-10	-7	-4	-8	-11	-19	-27		-14	-9	-7	-4	-8	-14	-19	-26
16	-13	-7	-7	-5	-10	-9	-16	-23	16	-12	-7	-7	-5	-10	-9	-15	-22
	-11	-5	-7	-9	-11	-11	-14	-23		-10	-4	-6	-9	-11	-10	-13	-21
24-36	-10	-5	-5	-8	-12	-15	-18	-22	24-36	-9	-5	-5	-8	-12	-15	-18	-21
	-7	-5	-6	-10	-13	-16	-20	-24		-7	-5	-5	-9	-13	-16	-19	-22

SK11930

WAM_DC_00073GB_60HZ JM AEROFOIL
January 2024



FAN CODE: 63JM/25/4/6/...
630mm 1730 rev/min 6 Blades 60 Hz

Performance Data ISO 5801

Performance shown is for installations type D – Ducted inlet, Ducted outlet. Performance ratings do not include the effects of appurtenances.

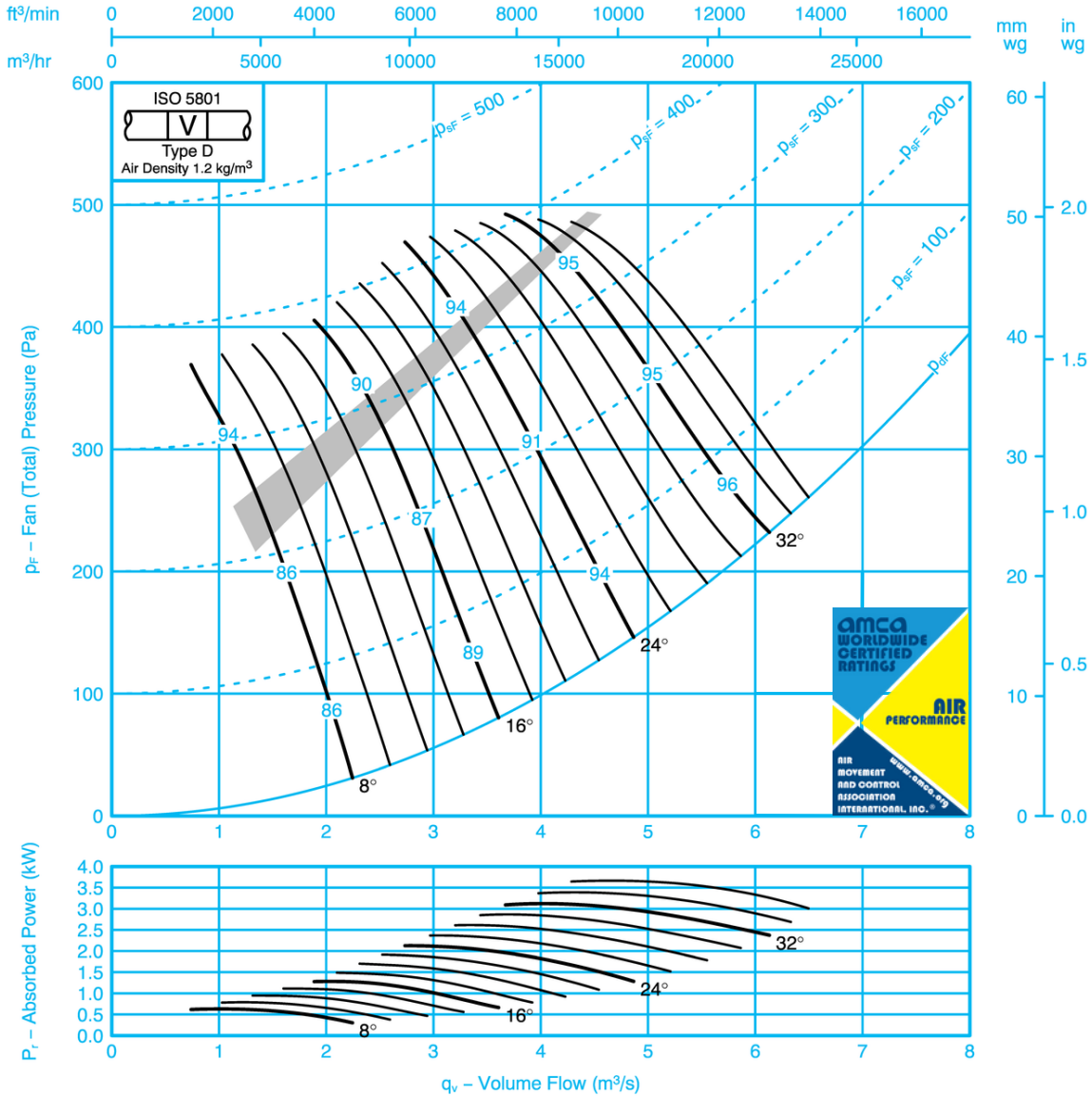

Sound Data ISO 5136

Single figures on performance curves are overall inlet sound power levels, derived from measurements taken in Woods laboratory specifically under ducted conditions. For sound power levels in eight octave bands, apply the following corrections to the overall level. Use upper corrections when operating point is above shaded area, or lower corrections when operating point is below shaded area.

Inlet Levels								Outlet Levels									
Pitch Angle	Octave Band Centre Frequency (Hz)								Pitch Angle	Octave Band Centre Frequency (Hz)							
	63	125	250	500	1k	2k	4k	8k		63	125	250	500	1k	2k	4k	8k
8	-15	-10	-7	-6	-6	-9	-16	-25	8	-13	-8	-8	-5	-5	-9	-16	-23
	-11	-5	-7	-9	-10	-11	-10	-17		-10	-4	-6	-9	-10	-10	-9	-15
16	-8	-7	-7	-7	-11	-10	-14	-21	16	-7	-6	-6	-7	-11	-10	-13	-20
	-8	-4	-7	-9	-13	-13	-14	-21		-7	-3	-6	-9	-13	-13	-14	-20
24-36	-5	-7	-8	-8	-13	-14	-18	-23	24-36	-3	-5	-7	-8	-12	-13	-17	-21
	-5	-5	-9	-10	-15	-16	-19	-25		-2	-3	-8	-9	-15	-16	-18	-24

SK11932

WAM_DC_00073GB_60HZ JM AEROFOIL
January 2024



FAN CODE: 63JM/25/4/9/...
630mm 1730 rev/min 9 Blades 60 Hz

Performance Data ISO 5801

Performances shown is for installations type D – Ducted inlet, Ducted outlet. Performance ratings do not include the effects of appurtenances.

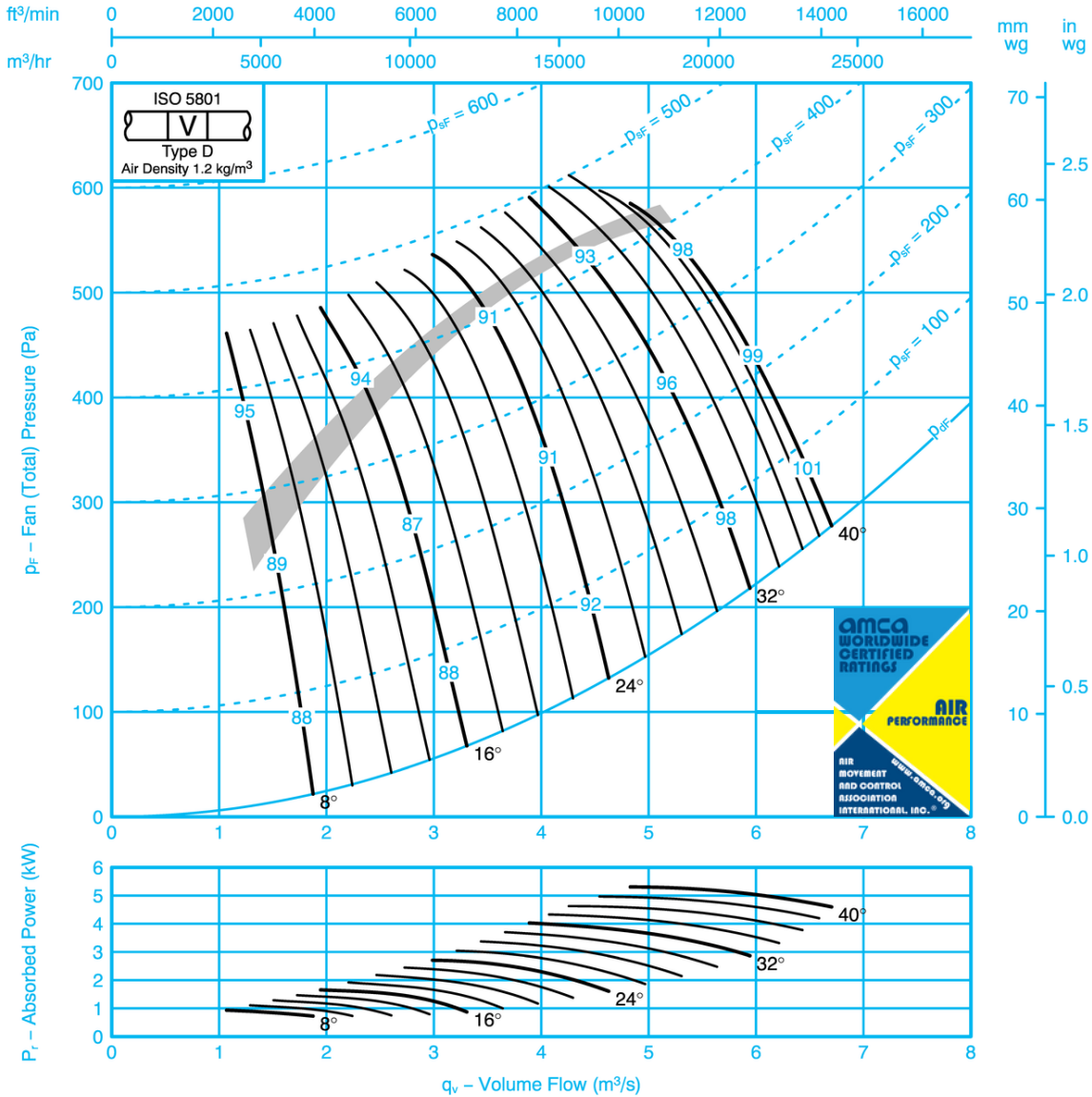

Sound Data ISO 5136

Single figures on performance curves are overall inlet sound power levels, derived from measurements taken in Woods laboratory specifically under ducted conditions. For sound power levels in eight octave bands, apply the following corrections to the overall level. Use upper corrections when operating point is above shaded area, or lower corrections when operating point is below shaded area.

Inlet Levels								Outlet Levels									
Pitch Angle	Octave Band Centre Frequency (Hz)								Pitch Angle	Octave Band Centre Frequency (Hz)							
	63	125	250	500	1k	2k	4k	8k		63	125	250	500	1k	2k	4k	8k
8	-15	-11	-9	-8	-5	-7	-15	-24	8	-12	-10	-7	-7	-4	-7	-14	-22
	-14	-11	-9	-8	-7	-7	-9	-17		-12	-10	-7	-8	-7	-6	-7	-15
16	-13	-11	-7	-7	-6	-9	-15	-22	16	-11	-11	-5	-6	-6	-8	-14	-21
	-9	-9	-5	-8	-11	-11	-12	-19		-7	-9	-3	-8	-11	-11	-11	-18
24-40	-6	-8	-6	-8	-13	-14	-17	-21	24-40	-4	-7	-4	-7	-12	-13	-16	-20
	-5	-7	-7	-9	-15	-16	-19	-25		-2	-6	-5	-9	-15	-15	-18	-24

SK11933

WAM_DC_00073GB_60HZ JM AEROFOIL
January 2024



FAN CODE: 63JM/31/2/9/...
630mm 3500 rev/min 9 Blades 60 Hz

Performance Data ISO 5801

Performance shown is for installations type D - Ducted inlet, Ducted outlet. Performance ratings do not include the effects of appurtenances.

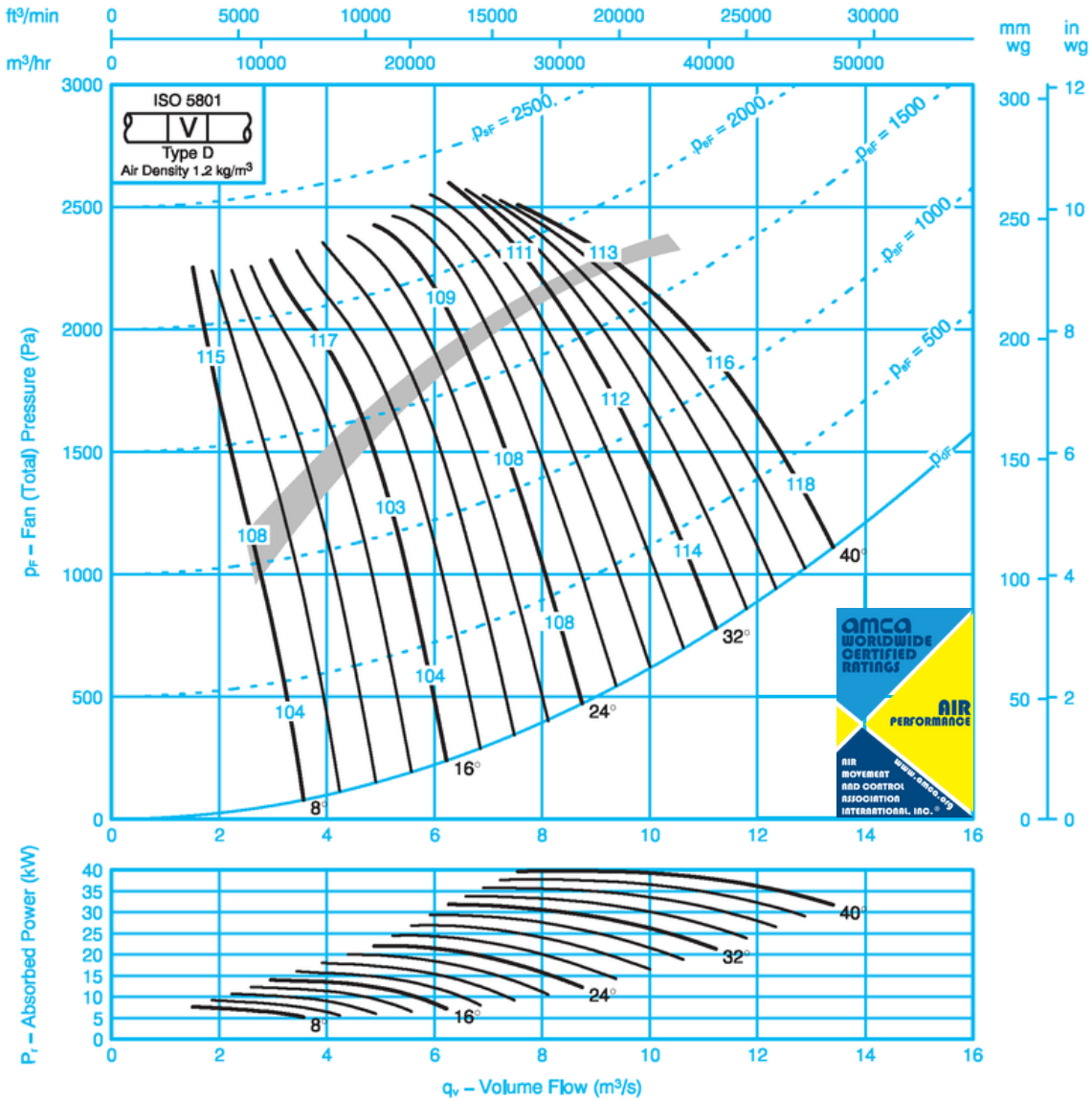

If it is intended to run this fan in reverse for other than emergency operation, please refer to Woods Air Movement.

Sound Data ISO 5136

Single figures on performance curves are overall inlet sound power levels, derived from measurements taken in Woods laboratory specifically under ducted conditions. For sound power levels in eight octave bands, apply the following corrections to the overall level. Use upper corrections when operating point is above shaded area, or lower corrections when operating point is below shaded area.

Inlet Levels									Outlet Levels								
Pitch Angle	Octave Band Centre Frequency (Hz)								Pitch Angle	Octave Band Centre Frequency (Hz)							
	63	125	250	500	1k	2k	4k	8k		63	125	250	500	1k	2k	4k	8k
8	-17	-14	-11	-9	-7	-5	-9	-16	8	-14	-13	-10	-7	-6	-4	-9	-15
	-15	-13	-10	-9	-8	-7	-8	-9		-14	-13	-10	-7	-7	-6	-7	-7
16	-14	-12	-11	-7	-5	-7	-10	-16	16	-13	-12	-11	-6	-5	-7	-10	-15
	-10	-9	-9	-6	-9	-11	-12	-12		-9	-9	-9	-4	-8	-11	-11	-11
24 - 40	-8	-6	-9	-6	-9	-14	-15	-18	24 - 40	-7	-6	-9	-5	-8	-13	-14	-17
	-7	-5	-8	-8	-10	-16	-17	-21		-4	-5	-8	-6	-10	-16	-16	-20



Performance Data ISO 5801

Performances shown is for installation type D – Ducted inlet, Ducted outlet. Performance ratings do not include the effects of appurtenances.

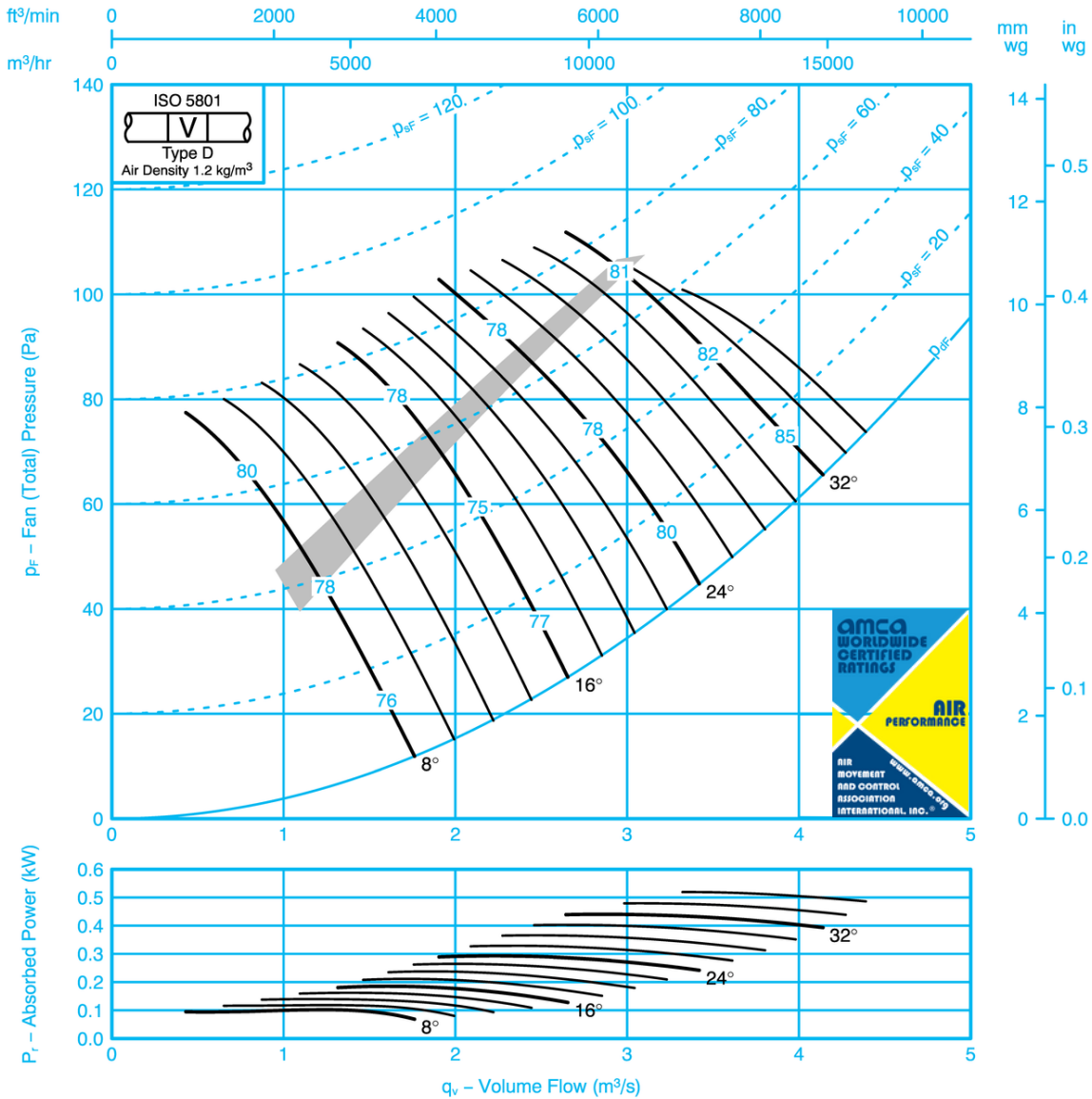

Sound Data ISO 5136

Single figures on performance curves are overall inlet sound power levels, derived from measurements taken in Woods laboratory specifically under ducted conditions. For sound power levels in eight octave bands, apply the following corrections to the overall level. Use upper corrections when operating point is above shaded area, or lower corrections when operating point is below shaded area.

Inlet Levels									Outlet Levels								
Pitch Angle	Octave Band Centre Frequency (Hz)								Pitch Angle	Octave Band Centre Frequency (Hz)							
	63	125	250	500	1k	2k	4k	8k		63	125	250	500	1k	2k	4k	8k
8	-12	-7	-3	-7	-12	-19	-25	-34	8	-10	-7	-3	-7	-12	-18	-24	-31
	-7	-7	-6	-7	-10	-14	-20	-28		-5	-7	-6	-7	-10	-13	-19	-26
16	-7	-7	-4	-9	-12	-15	-22	-29	16	-6	-6	-4	-9	-12	-15	-20	-27
	-3	-6	-10	-12	-13	-15	-20	-26		-2	-6	-10	-12	-13	-15	-19	-24
24-36	-3	-7	-9	-11	-11	-14	-18	-23	24-36	-2	-7	-9	-11	-11	-14	-16	-21
	-3	-7	-10	-13	-14	-17	-21	-27		-2	-7	-10	-13	-14	-17	-19	-24



FAN CODE: 71JM/25/8/6/...
710mm 830 rev/min 6 Blades 60 Hz

Performance Data ISO 5801

Performance shown is for installations type D – Ducted inlet, Ducted outlet. Performance ratings do not include the effects of appurtenances.

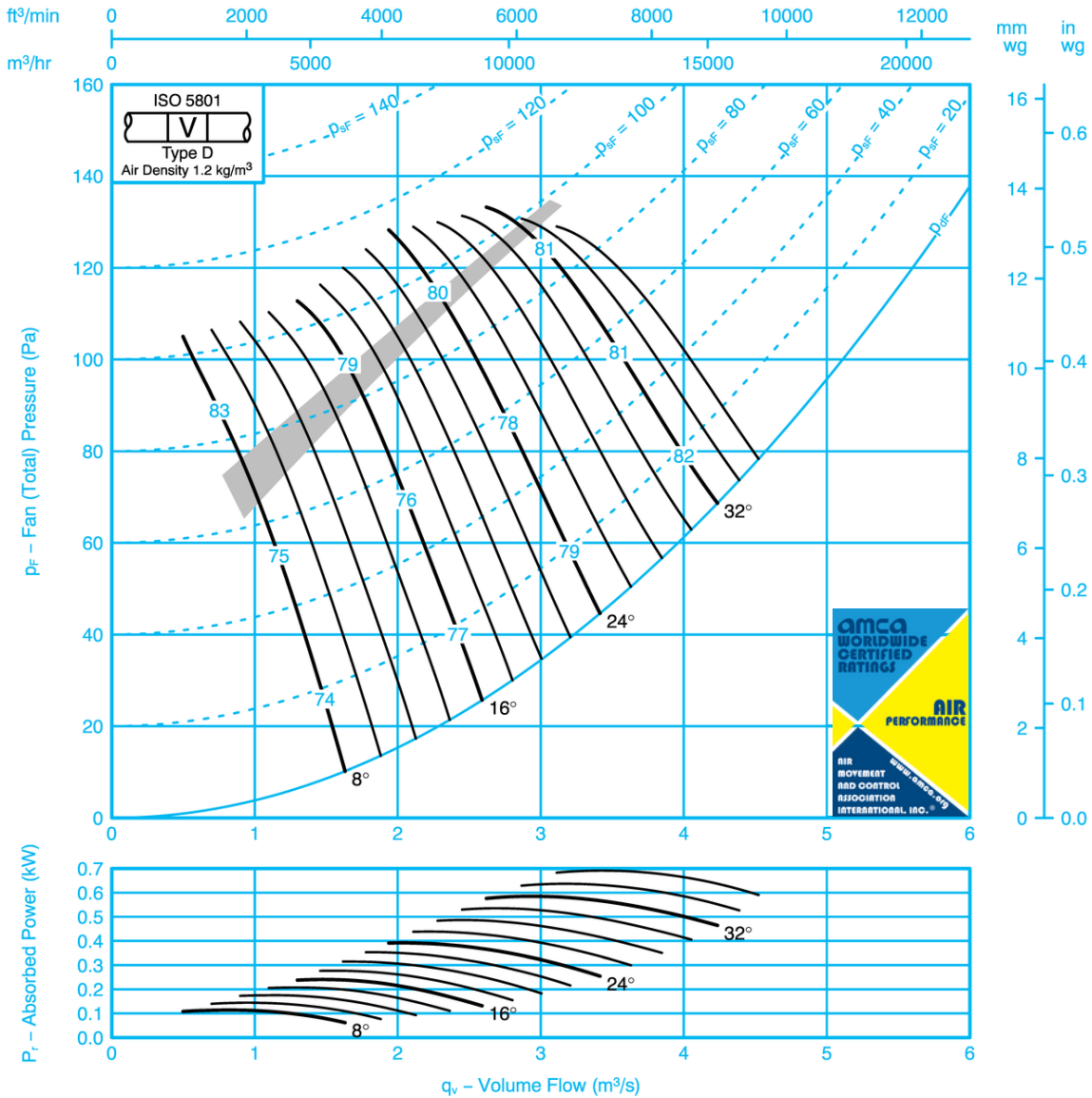

Sound Data ISO 5136

Single figures on performance curves are overall inlet sound power levels, derived from measurements taken in Woods laboratory specifically under ducted conditions. For sound power levels in eight octave bands, apply the following corrections to the overall level. Use upper corrections when operating point is above shaded area, or lower corrections when operating point is below shaded area.

Inlet Levels									Outlet Levels								
Pitch Angle	Octave Band Centre Frequency (Hz)								Pitch Angle	Octave Band Centre Frequency (Hz)							
	63	125	250	500	1k	2k	4k	8k		63	125	250	500	1k	2k	4k	8k
8	-12	-11	-6	-4	-8	-15	-23	-33	8	-10	-10	-6	-4	-8	-15	-22	-31
	-7	-9	-8	-7	-7	-9	-15	-24		-6	-8	-8	-7	-7	-9	-14	-22
16	-7	-7	-7	-7	-8	-13	-19	-27	16	-6	-6	-7	-7	-8	-12	-19	-26
	-4	-6	-8	-11	-12	-13	-19	-25		-3	-5	-8	-11	-12	-13	-18	-25
24-36	-6	-6	-7	-9	-11	-15	-19	-24	24-36	-4	-6	-7	-9	-10	-14	-17	-22
	-4	-7	-7	-10	-12	-15	-20	-26		-1	-6	-7	-10	-12	-15	-19	-25

SK11939

WAM_DC_00073GB_60HZ JM AEROFOIL
January 2024



FAN CODE: 71JM/25/8/9/...
710mm 830 rev/min 9 Blades 60 Hz

Performance Data ISO 5801

Performances shown is for installations type D – Ducted inlet, Ducted outlet. Performance ratings do not include the effects of appurtenances.

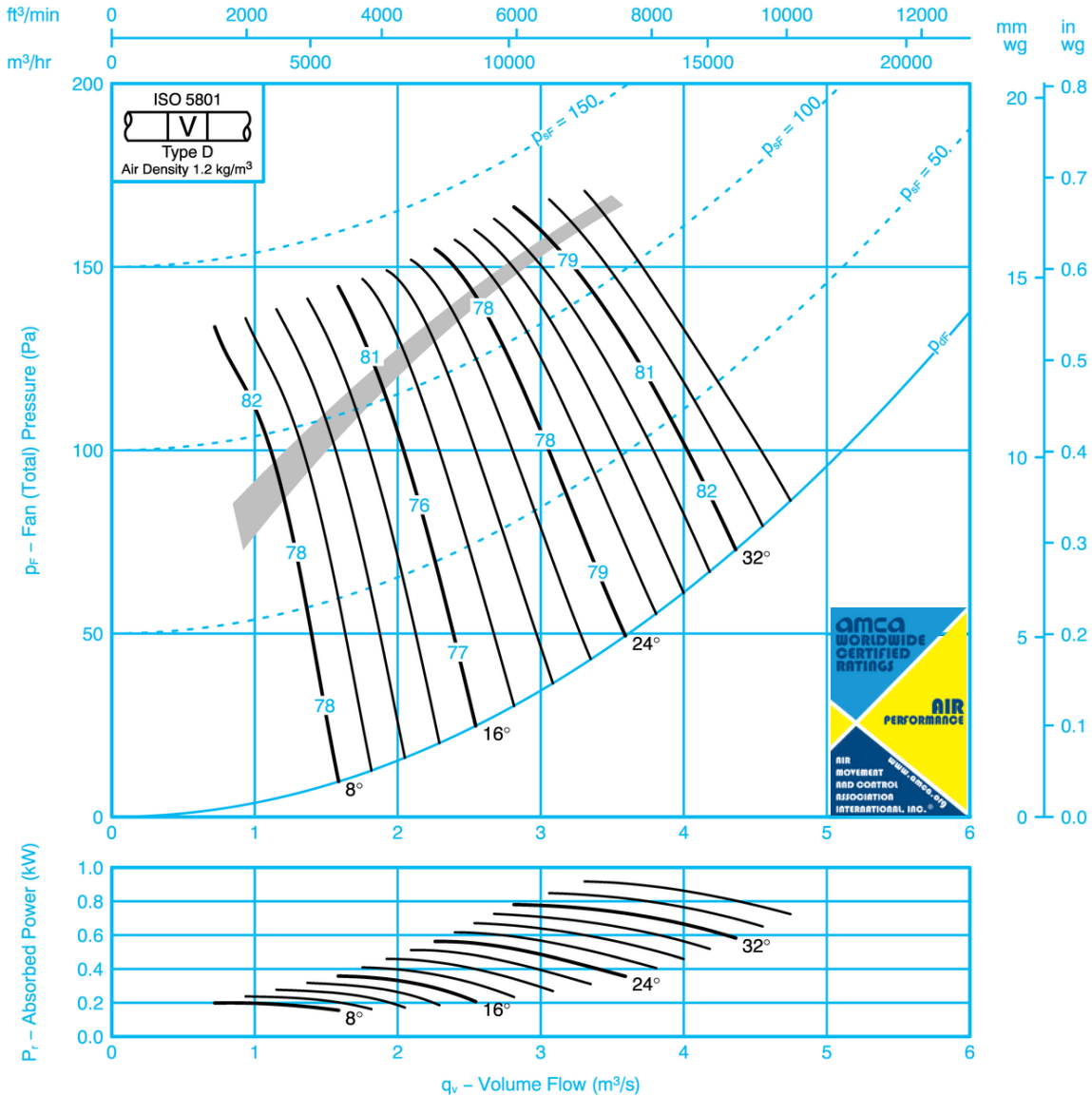

Sound Data ISO 5136

Single figures on performance curves are overall inlet sound power levels, derived from measurements taken in Woods laboratory specifically under ducted conditions. For sound power levels in eight octave bands, apply the following corrections to the overall level. Use upper corrections when operating point is above shaded area, or lower corrections when operating point is below shaded area.

Inlet Levels									Outlet Levels								
Pitch Angle	Octave Band Centre Frequency (Hz)								Pitch Angle	Octave Band Centre Frequency (Hz)							
	63	125	250	500	1k	2k	4k	8k		63	125	250	500	1k	2k	4k	8k
8	-11	-8	-8	-4	-7	-14	-23	-33	8	-9	-6	-8	-4	-7	-13	-22	-32
	-10	-9	-8	-6	-7	-8	-16	-25		-9	-7	-8	-6	-7	-8	-15	-23
16	-10	-8	-6	-6	-9	-14	-21	-29	16	-9	-6	-6	-5	-8	-14	-20	-28
	-9	-5	-6	-9	-10	-12	-17	-25		-7	-3	-6	-9	-10	-12	-17	-25
24-36	-7	-6	-6	-8	-10	-14	-18	-23	24-36	-6	-4	-6	-8	-10	-13	-16	-21
	-6	-5	-6	-10	-12	-15	-20	-26		-4	-3	-6	-10	-12	-14	-19	-25

SK11940

WAM_DC_00073GB_60HZ JM AEROFOIL
January 2024



Performance Data ISO 5801

Performance shown is for installations type D – Ducted inlet, Ducted outlet. Performance ratings do not include the effects of appurtenances.

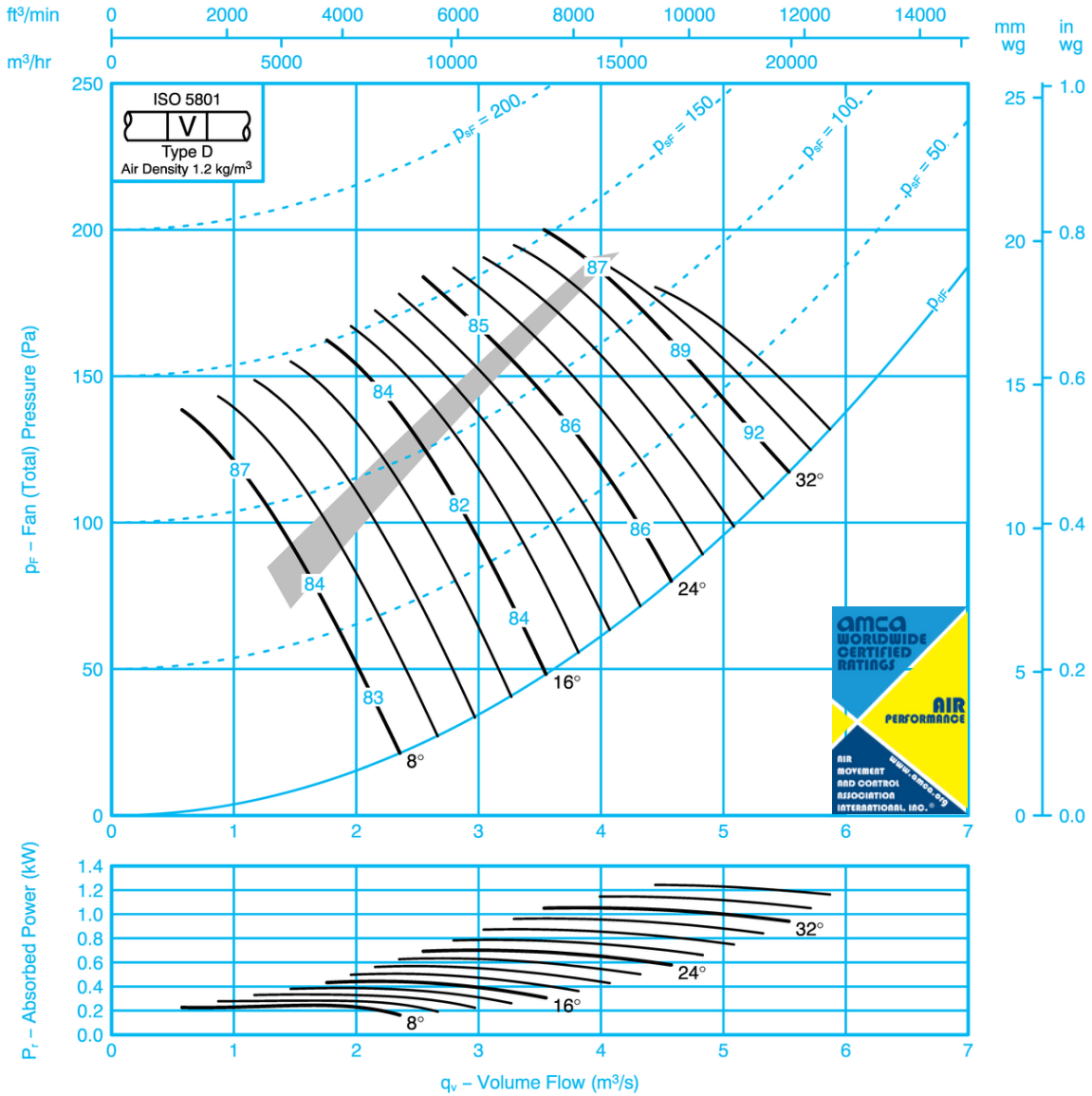

Sound Data ISO 5136

Single figures on performance curves are overall inlet sound power levels, derived from measurements taken in Woods laboratory specifically under ducted conditions. For sound power levels in eight octave bands, apply the following corrections to the overall level. Use upper corrections when operating point is above shaded area, or lower corrections when operating point is below shaded area.

Inlet Levels								Outlet Levels									
Pitch Angle	Octave Band Centre Frequency (Hz)								Pitch Angle	Octave Band Centre Frequency (Hz)							
	63	125	250	500	1k	2k	4k	8k		63	125	250	500	1k	2k	4k	8k
8	-12	-9	-3	-7	-11	-18	-23	-31	8	-10	-9	-3	-7	-11	-17	-22	-28
	-6	-9	-4	-8	-11	-14	-20	-27		-4	-9	-7	-7	-9	-13	-17	-24
16	-6	-9	-4	-8	-11	-14	-20	-27	16	-5	-9	-4	-8	-11	-14	-19	-24
	-2	-7	-10	-14	-14	-16	-19	-25		-2	-7	-10	-14	-14	-16	-18	-23
24-36	-3	-8	-9	-11	-12	-13	-17	-21	24-36	-2	-8	-9	-11	-12	-13	-16	-20
	-2	-8	-9	-13	-15	-17	-21	-26		-1	-8	-9	-13	-15	-16	-19	-23

SK11941

WAM_DC_00073GB_60HZ JM AEROFOIL
January 2024



Performance Data ISO 5801

Performances shown is for installations type D – Ducted inlet, Ducted outlet. Performance ratings do not include the effects of appurtenances.

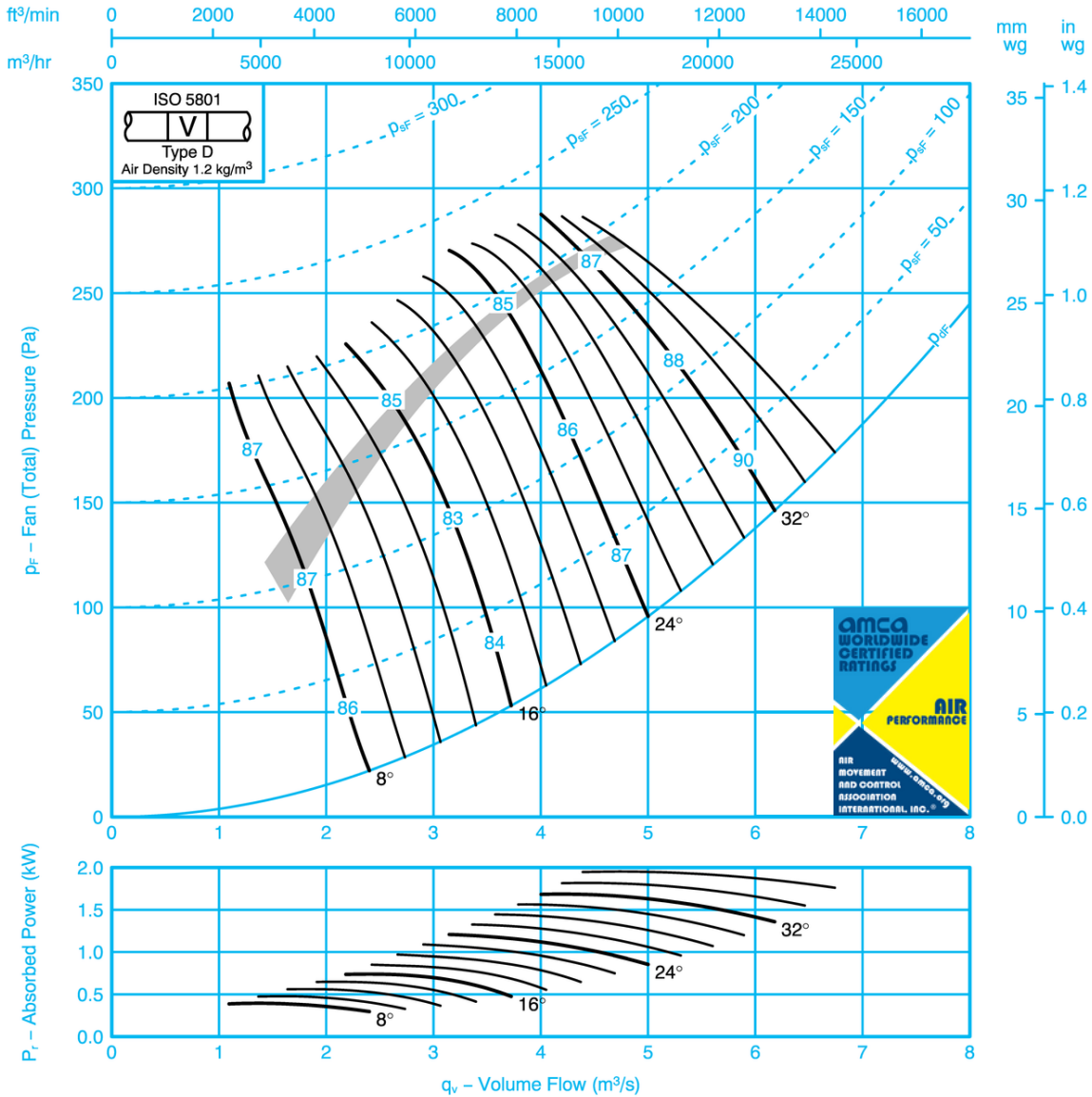

Sound Data ISO 5136

Single figures on performance curves are overall inlet sound power levels, derived from measurements taken in Woods laboratory specifically under ducted conditions. For sound power levels in eight octave bands, apply the following corrections to the overall level. Use upper corrections when operating point is above shaded area, or lower corrections when operating point is below shaded area.

Inlet Levels								Outlet Levels									
Pitch Angle	Octave Band Centre Frequency (Hz)							Pitch Angle	Octave Band Centre Frequency (Hz)								
	63	125	250	500	1k	2k	4k		8k	63	125	250	500	1k	2k	4k	8k
8	-10	-6	-4	-9	-11	-20	-26	-33	8	-9	-6	-4	-8	-11	-20	-25	-31
	-13	-9	-5	-5	-8	-17	-22	-31		-13	-8	-5	-5	-8	-16	-22	-29
16	-12	-6	-4	-8	-9	-14	-23	-32	16	-11	-6	-4	-8	-9	-14	-22	-30
	-8	-5	-6	-10	-9	-13	-19	-26		-8	-4	-6	-10	-9	-12	-19	-25
24-36	-9	-4	-6	-10	-12	-14	-18	-23	24-36	-8	-4	-6	-10	-12	-14	-17	-22
	-6	-4	-8	-11	-13	-15	-20	-25		-6	-3	-8	-11	-13	-15	-18	-23



FAN CODE: 71JM/25/6/6/...
710mm 1110 rev/min 6 Blades 60 Hz

Performance Data ISO 5801

Performance shown is for installations type D – Ducted inlet, Ducted outlet. Performance ratings do not include the effects of appurtenances.

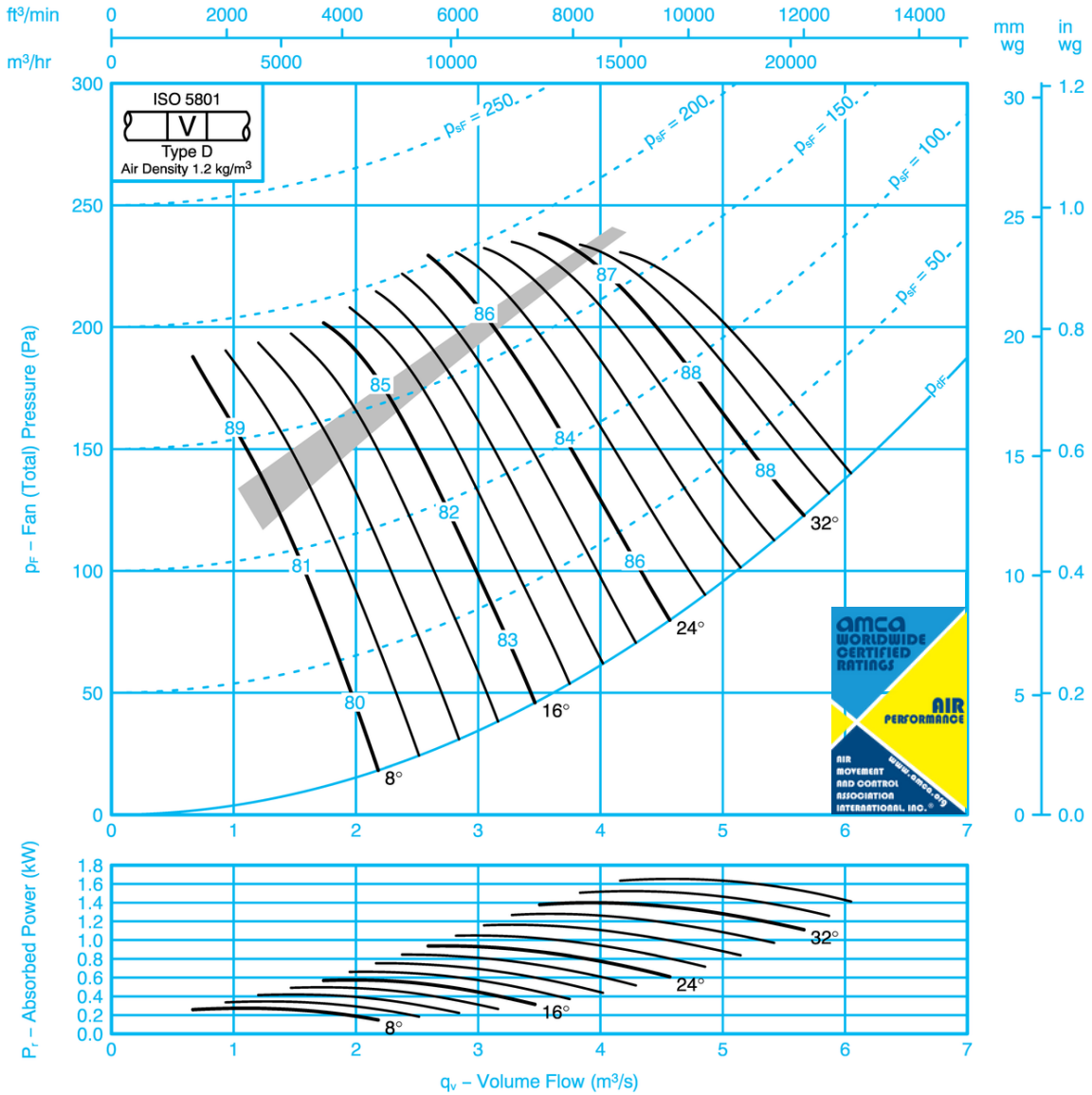

Sound Data ISO 5136

Single figures on performance curves are overall inlet sound power levels, derived from measurements taken in Woods laboratory specifically under ducted conditions. For sound power levels in eight octave bands, apply the following corrections to the overall level. Use upper corrections when operating point is above shaded area, or lower corrections when operating point is below shaded area.

Inlet Levels								Outlet Levels									
Pitch Angle	Octave Band Centre Frequency (Hz)								Pitch Angle	Octave Band Centre Frequency (Hz)							
	63	125	250	500	1k	2k	4k	8k		63	125	250	500	1k	2k	4k	8k
8	-12	-12	-7	-4	-6	-14	-21	-29	8	-10	-10	-7	-4	-6	-13	-20	-27
	-7	-9	-8	-8	-7	-9	-14	-21		-6	-8	-9	-8	-7	-8	-13	-19
16	-7	-7	-7	-8	-8	-12	-18	-24	16	-6	-6	-7	-8	-7	-11	-18	-23
	-4	-6	-8	-11	-11	-14	-17	-24		-3	-5	-8	-11	-11	-14	-17	-23
24-36	-5	-7	-7	-9	-10	-14	-18	-22	24-36	-4	-6	-7	-9	-10	-13	-19	-20
	-4	-7	-8	-10	-12	-15	-20	-24		-2	-6	-8	-10	-12	-15	-19	-23

SK11944

WAM_DC_00073GB_60HZ JM AEROFOIL
January 2024



FAN CODE: 71JM/25/6/9/...
710mm 1110 rev/min 9 Blades 60 Hz

Performance Data ISO 5801

Performances shown is for installations type D – Ducted inlet, Ducted outlet. Performance ratings do not include the effects of appurtenances.

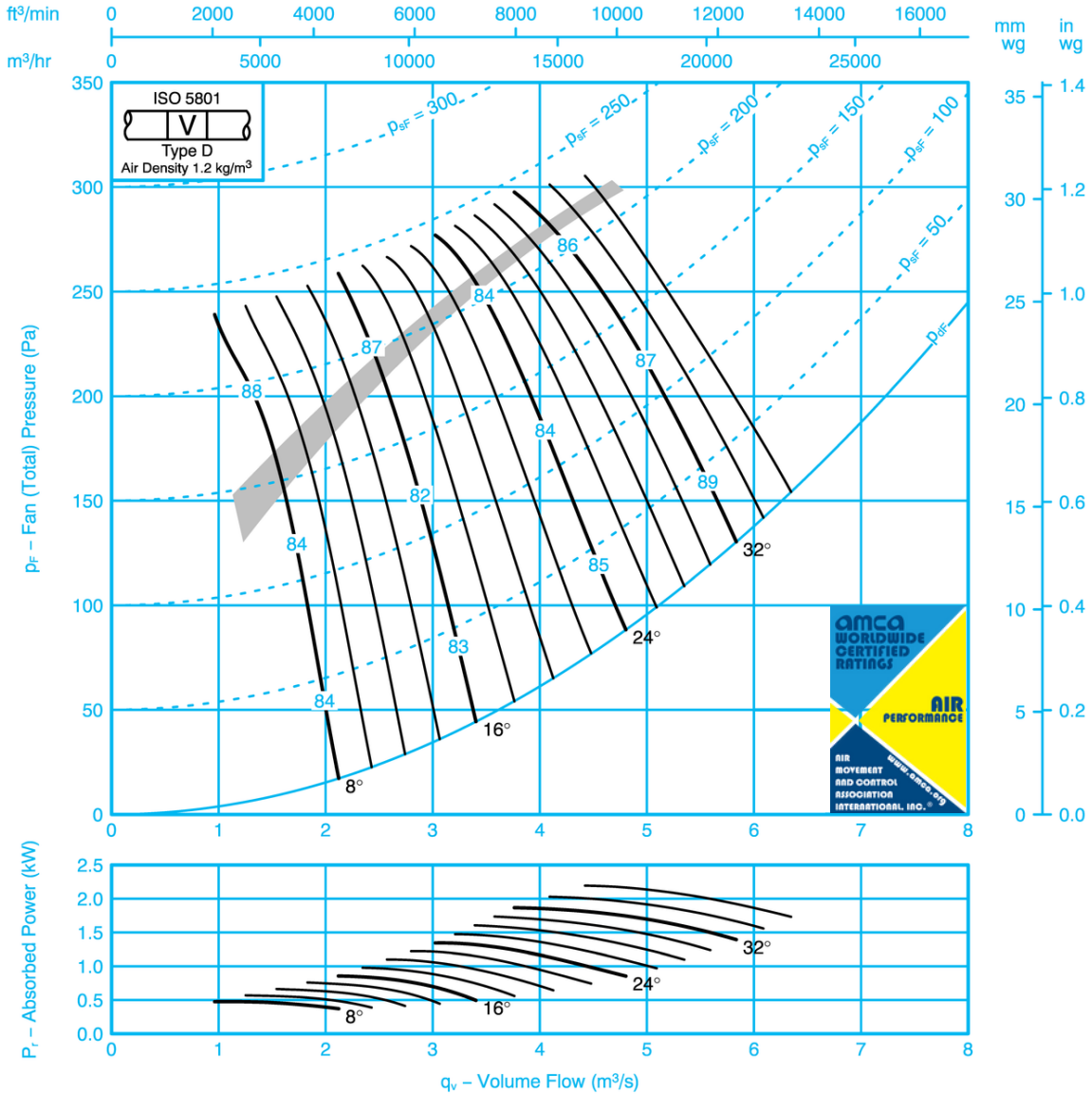

Sound Data ISO 5136

Single figures on performance curves are overall inlet sound power levels, derived from measurements taken in Woods laboratory specifically under ducted conditions. For sound power levels in eight octave bands, apply the following corrections to the overall level. Use upper corrections when operating point is above shaded area, or lower corrections when operating point is below shaded area.

Inlet Levels									Outlet Levels								
Pitch Angle	Octave Band Centre Frequency (Hz)								Pitch Angle	Octave Band Centre Frequency (Hz)							
	63	125	250	500	1k	2k	4k	8k		63	125	250	500	1k	2k	4k	8k
8	-11	-9	-9	-5	-5	-13	-21	-29	8	-9	-7	-8	-5	-5	-12	-20	-28
	-11	-10	-8	-7	-6	-8	-13	-22		-10	-8	-7	-7	-6	-7	-12	-21
16	-10	-9	-7	-5	-8	-13	-19	-26	16	-9	-7	-6	-5	-7	-13	-19	-25
	-8	-7	-6	-8	-9	-12	-16	-23		-7	-5	-5	-8	-9	-12	-15	-22
24-36	-7	-7	-6	-8	-10	-13	-17	-21	24-36	-5	-5	-6	-8	-9	-12	-16	-19
	-6	-7	-6	-9	-11	-14	-19	-24		-3	-5	-5	-9	-11	-14	-18	-23

SK11945

WAM_DC_00073GB_60HZ JM AEROFOIL
January 2024



FAN CODE: 71JM/20/4/3/...
710mm 1730 rev/min 3 Blades 60 Hz

Performance Data ISO 5801

Performance shown is for installations type D – Ducted inlet, Ducted outlet. Performance ratings do not include the effects of appurtenances.

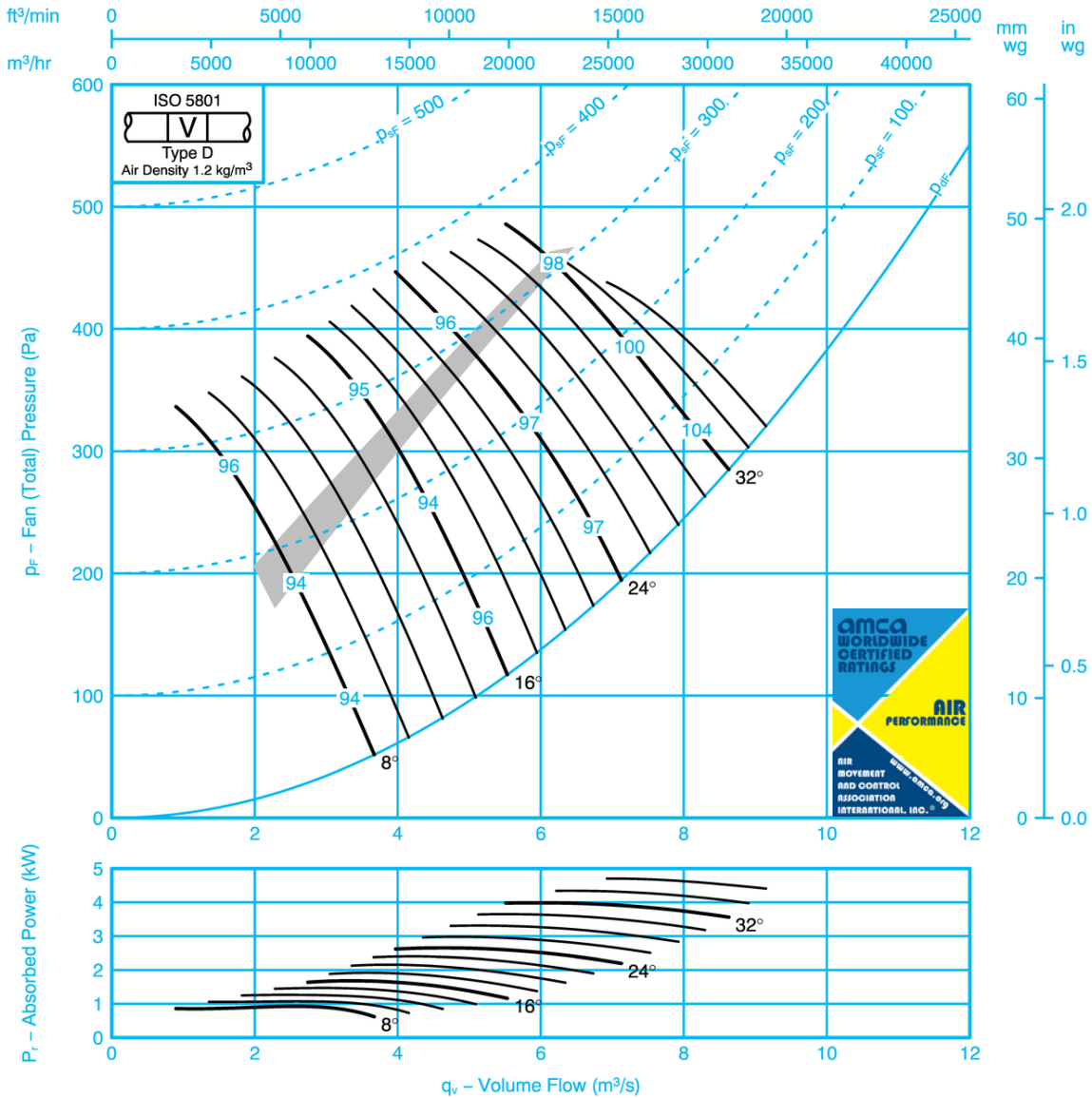

If it is intended to run this fan in reverse for other than emergency operation, please refer to Woods Air Movement.

Sound Data ISO 5136

Single figures on performance curves are overall inlet sound power levels, derived from measurements taken in Woods laboratory specifically under ducted conditions. For sound power levels in eight octave bands, apply the following corrections to the overall level. Use upper corrections when operating point is above shaded area, or lower corrections when operating point is below shaded area.

Inlet Levels								Outlet Levels									
Pitch Angle	Octave Band Centre Frequency (Hz)								Pitch Angle	Octave Band Centre Frequency (Hz)							
	63	125	250	500	1k	2k	4k	8k		63	125	250	500	1k	2k	4k	8k
8	-12	-15	-9	-4	-9	-14	-21	-27	8	-9	-13	-7	-3	-8	-12	-19	-23
	-6	-10	-10	-8	-10	-12	-17	-22		-4	-9	-9	-7	-9	-10	-15	-20
16	-7	-10	-8	-6	-12	-13	-17	-24	16	-5	-9	-7	-6	-11	-13	-15	-21
	-3	-7	-10	-14	-16	-17	-19	-24		-2	-6	-10	-13	-16	-16	-18	-21
24-36	-5	-6	-9	-12	-14	-13	-17	-20	24-36	-4	-5	-9	-11	-13	-12	-15	-18
	-4	-6	-10	-13	-17	-17	-21	-24		-2	-5	-9	-13	-16	-16	-19	-21

SK11946

WAM_DC_00073GB_60HZ JM AEROFOIL
January 2024



FAN CODE: 71JM/20/4/6/...
710mm 1730 rev/min 6 Blades 60 Hz

Performance Data ISO 5801

Performance shown is for installations type D – Ducted inlet, Ducted outlet. Performance ratings do not include the effects of appurtenances.

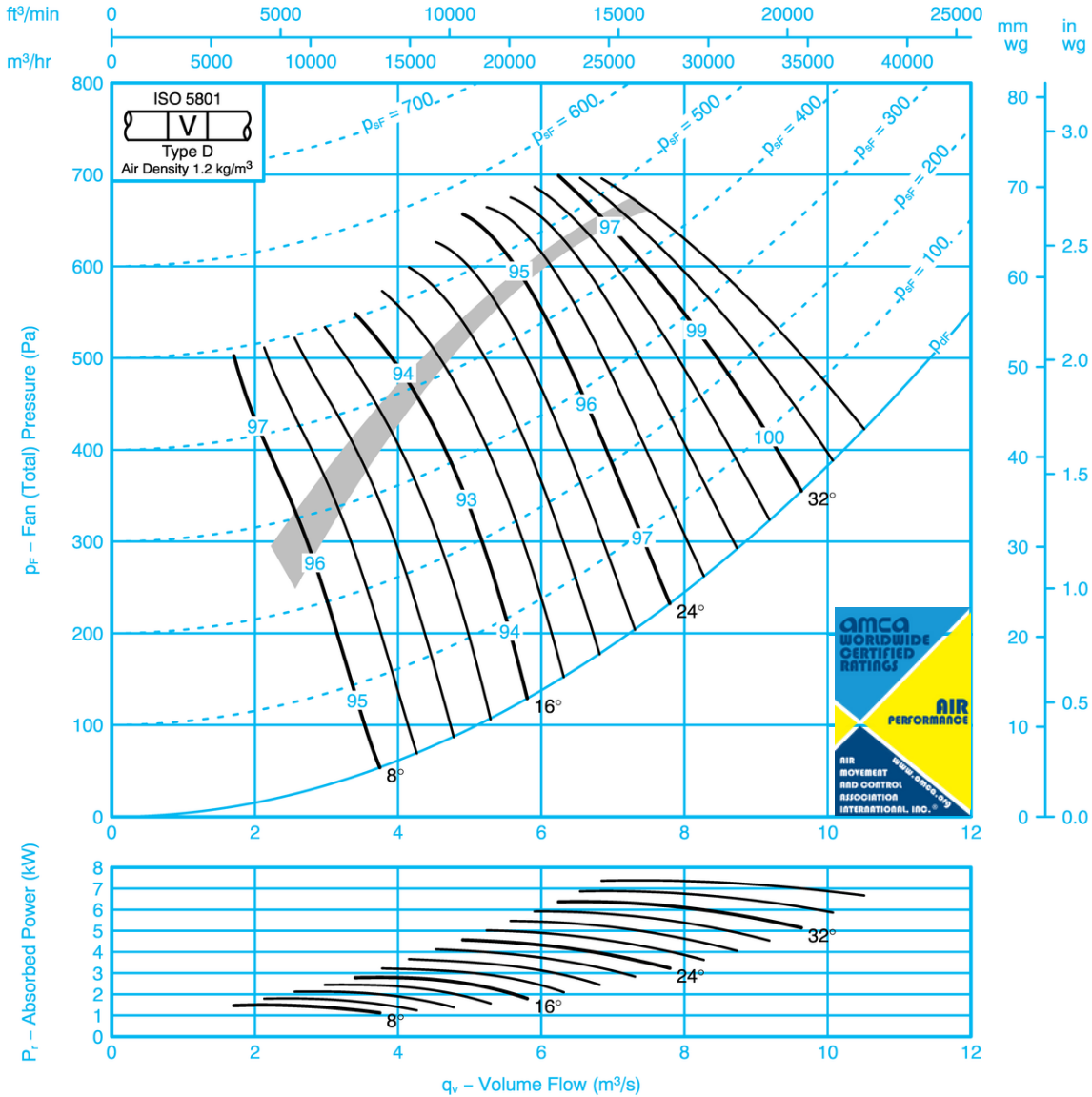

If it is intended to run this fan in reverse for other than emergency operation, please refer to Woods Air Movement.

Sound Data ISO 5136

Single figures on performance curves are overall inlet sound power levels, derived from measurements taken in Woods laboratory specifically under ducted conditions. For sound power levels in eight octave bands, apply the following corrections to the overall level. Use upper corrections when operating point is above shaded area, or lower corrections when operating point is below shaded area.

Inlet Levels								Outlet Levels								
Pitch Angle	Octave Band Centre Frequency (Hz)							Pitch Angle	Octave Band Centre Frequency (Hz)							
	63	125	250	500	1k	2k	4k		8k	63	125	250	500	1k	2k	4k
8	-17	-10	-7	-5	-10	-14	-22	8	-15	-8	-6	-4	-9	-13	-20	-25
	-18	-11	-8	-5	-7	-10	-18		-25	-17	-10	-8	-4	-7	-8	-18
16	-16	-11	-7	-6	-10	-12	-17	16	-14	-9	-6	-5	-9	-11	-15	-23
	-11	-6	-7	-9	-11	-11	-15		-22	-10	-5	-6	-9	-10	-10	-13
24-36	-12	-8	-6	-7	-12	-13	-16	24-36	-10	-7	-5	-6	-12	-12	-15	-18
	-9	-6	-5	-9	-13	-14	-18		-22	-8	-5	-5	-9	-12	-13	-16

SK11947

WAM_DC_00073GB_60HZ JM AEROFOIL
January 2024



FAN CODE: 80JM/20/8/3/...
 800mm 830 rev/min 3 Blades 60 Hz

Performance Data ISO 5801

Performances shown is for installation type D – Ducted inlet, Ducted outlet. Performance ratings do not include the effects of appurtenances.

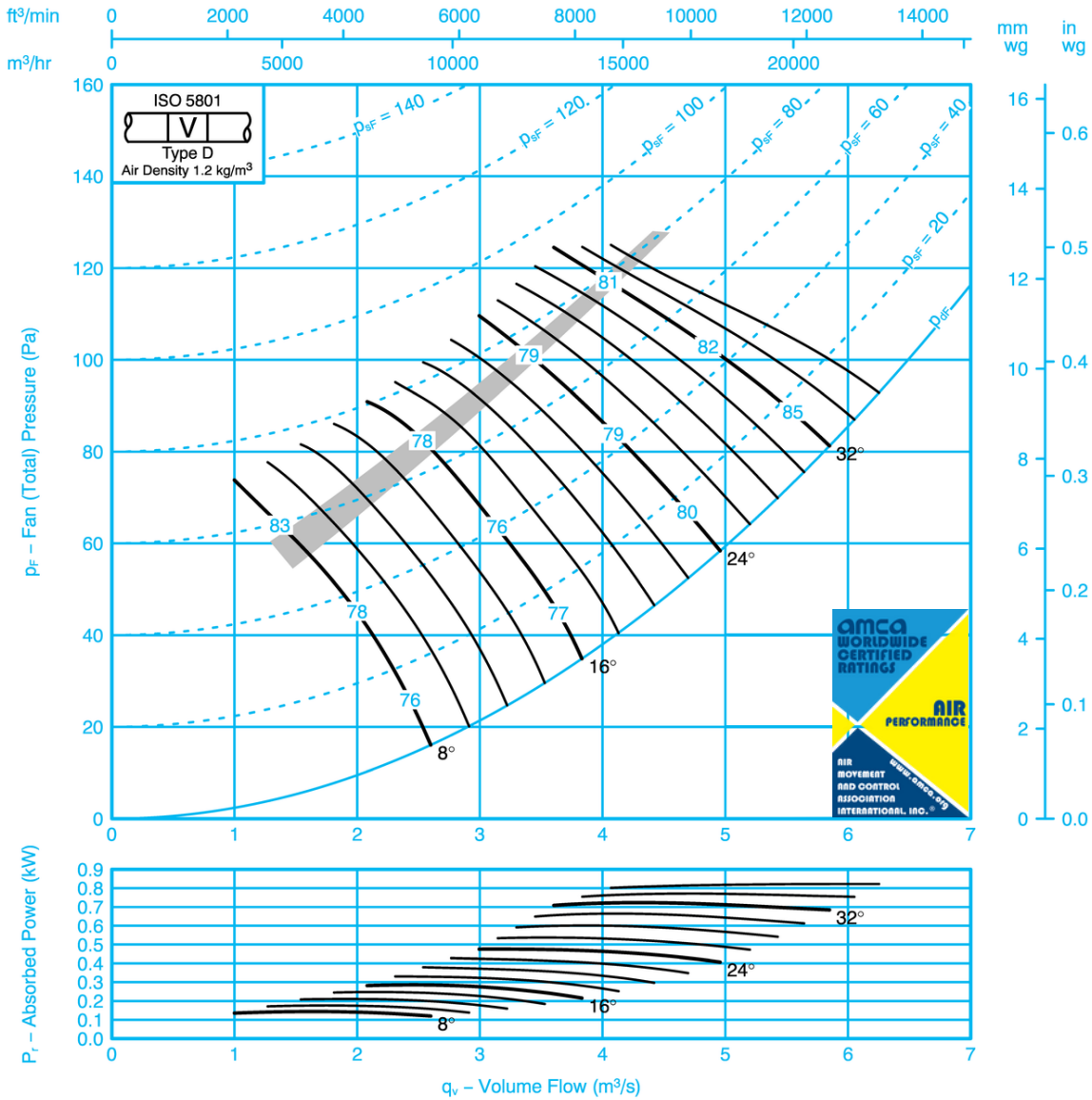

Sound Data ISO 5136

Single figures on performance curves are overall inlet sound power levels, derived from measurements taken in Woods laboratory specifically under ducted conditions. For sound power levels in eight octave bands, apply the following corrections to the overall level. Use upper corrections when operating point is above shaded area, or lower corrections when operating point is below shaded area.

Inlet Levels									Outlet Levels								
Pitch Angle	Octave Band Centre Frequency (Hz)								Pitch Angle	Octave Band Centre Frequency (Hz)							
	63	125	250	500	1k	2k	4k	8k		63	125	250	500	1k	2k	4k	8k
8	-18	-7	-2	-9	-13	-21	-26	-35	8	-16	-7	-2	-9	-13	-20	-25	-32
	-12	-7	-5	-6	-8	-15	-21	-30		-11	-7	-5	-6	-8	-14	-20	-29
16	-8	-6	-5	-11	-9	-12	-18	-26	16	-7	-6	-5	-11	-9	-11	-12	-16
	-6	-5	-9	-10	-11	-13	-17	-24		-5	-5	-9	-10	-11	-12	-16	-22
24-36	-6	-8	-10	-10	-7	-10	-14	-20	24-36	-5	-8	-10	-10	-7	-10	-13	-18
	-4	-6	-9	-12	-10	-13	-17	-25		-4	-6	-9	-12	-10	-12	-15	-22

SK11952

WAM_DC_00073GB_60HZ JM AEROFOIL
 January 2024



Performance Data ISO 5801

Performances shown is for installation type D – Ducted inlet, Ducted outlet. Performance ratings do not include the effects of appurtenances.

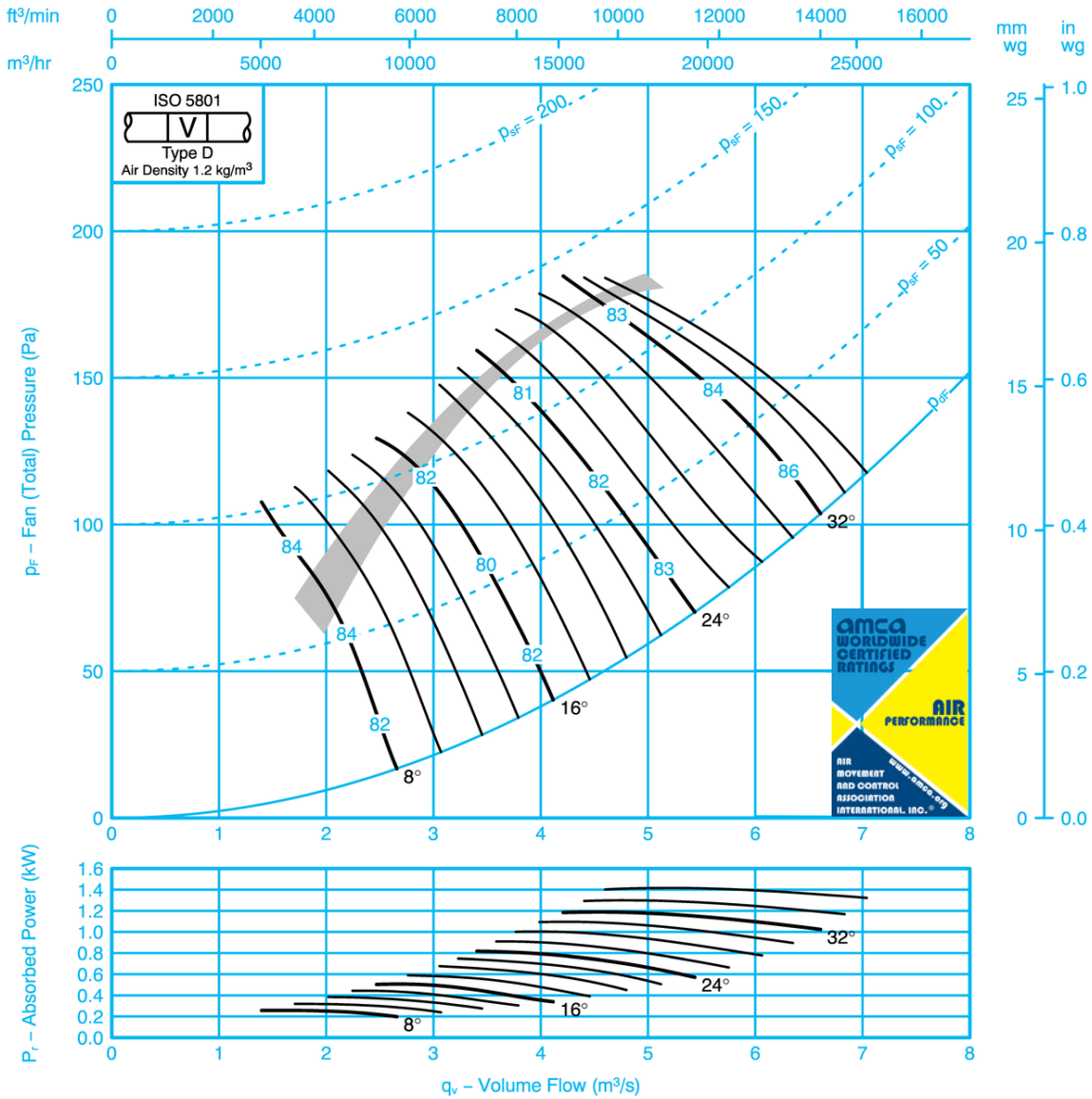

Sound Data ISO 5136

Single figures on performance curves are overall inlet sound power levels, derived from measurements taken in Woods laboratory specifically under ducted conditions. For sound power levels in eight octave bands, apply the following corrections to the overall level. Use upper corrections when operating point is above shaded area, or lower corrections when operating point is below shaded area.

Inlet Levels									Outlet Levels								
Pitch Angle	Octave Band Centre Frequency (Hz)								Pitch Angle	Octave Band Centre Frequency (Hz)							
	63	125	250	500	1k	2k	4k	8k		63	125	250	500	1k	2k	4k	8k
8	-12	-6	-4	-7	-11	-20	-26	-35	8	-10	-6	-4	-7	-11	-19	-25	-32
	-12	-9	-5	-5	-8	-17	-22	-32		-11	-9	-5	-5	-8	-16	-22	-31
16	-13	-5	-4	-10	-12	-18	-26	-35	16	-12	-5	-4	-10	-12	-18	-25	-33
	-6	-5	-8	-9	-10	-14	-20	-27		-6	-5	-8	-9	-10	-14	-19	-25
24-36	-10	-6	-5	-11	-9	-13	-17	-24	24-36	-9	-6	-5	-11	-9	-13	-16	-23
	-6	-4	-8	-11	-11	-14	-18	-25		-5	-4	-8	-11	-11	-14	-17	-23



FAN CODE: 80JM/25/8/6/...
800mm 830 rev/min 6 Blades 60 Hz

Performance Data ISO 5801

Performances shown is for installations type D – Ducted inlet, Ducted outlet. Performance ratings do not include the effects of appurtenances.

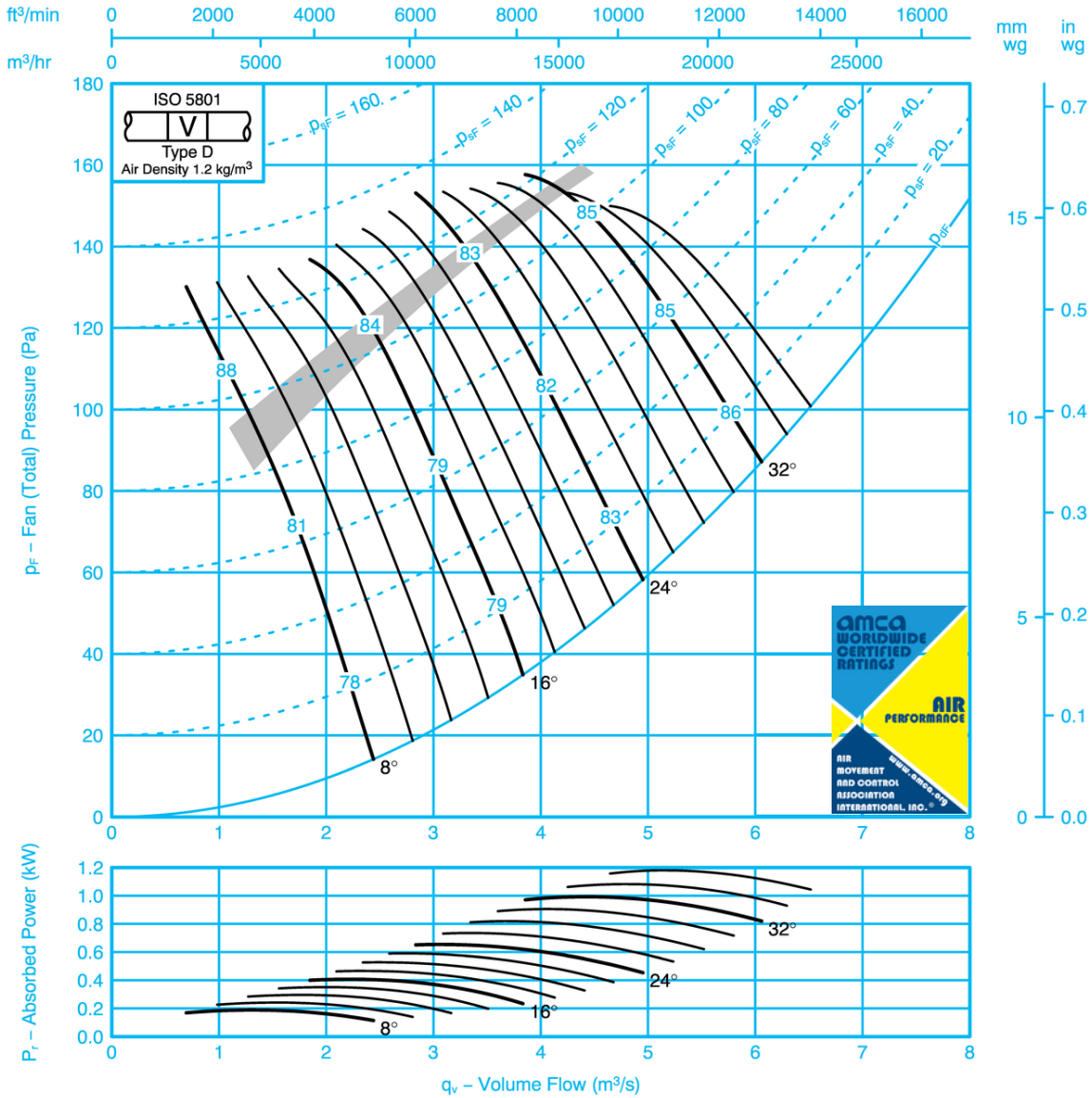

Sound Data ISO 5136

Single figures on performance curves are overall inlet sound power levels, derived from measurements taken in Woods laboratory specifically under ducted conditions. For sound power levels in eight octave bands, apply the following corrections to the overall level. Use upper corrections when operating point is above shaded area, or lower corrections when operating point is below shaded area.

Inlet Levels									Outlet Levels								
Pitch Angle	Octave Band Centre Frequency (Hz)								Pitch Angle	Octave Band Centre Frequency (Hz)							
	63	125	250	500	1k	2k	4k	8k		63	125	250	500	1k	2k	4k	8k
8	-15	-13	-6	-3	-8	-15	-22	-32	8	-13	-13	-6	-4	-8	-15	-21	-30
	-11	-13	-9	-5	-5	-10	-16	-24		-11	-13	-9	-7	-6	-9	-16	-23
16	-9	-9	-9	-4	-8	-13	-19	-28	16	-7	-9	-9	-5	-8	-13	-19	-26
	-5	-6	-8	-10	-11	-13	-17	-23		-5	-5	-8	-10	-11	-13	-16	-21
24-36	-6	-7	-8	-7	-9	-13	-16	-22	24-36	-5	-7	-8	-8	-9	-13	-16	-21
	-5	-7	-7	-8	-10	-14	-17	-23		-5	-7	-7	-9	-10	-14	-16	-21

SK11955

WAM_DC_00073GB_60HZ JM AEROFOIL
January 2024



JM AEROFOIL

FAN CODE: 80JM/25/8/9/...

800mm 830 rev/min 9 Blades 60 Hz



Performance Data ISO 5801

Performances shown is for installations type D – Ducted inlet, Ducted outlet. Performance ratings do not include the effects of appurtenances.

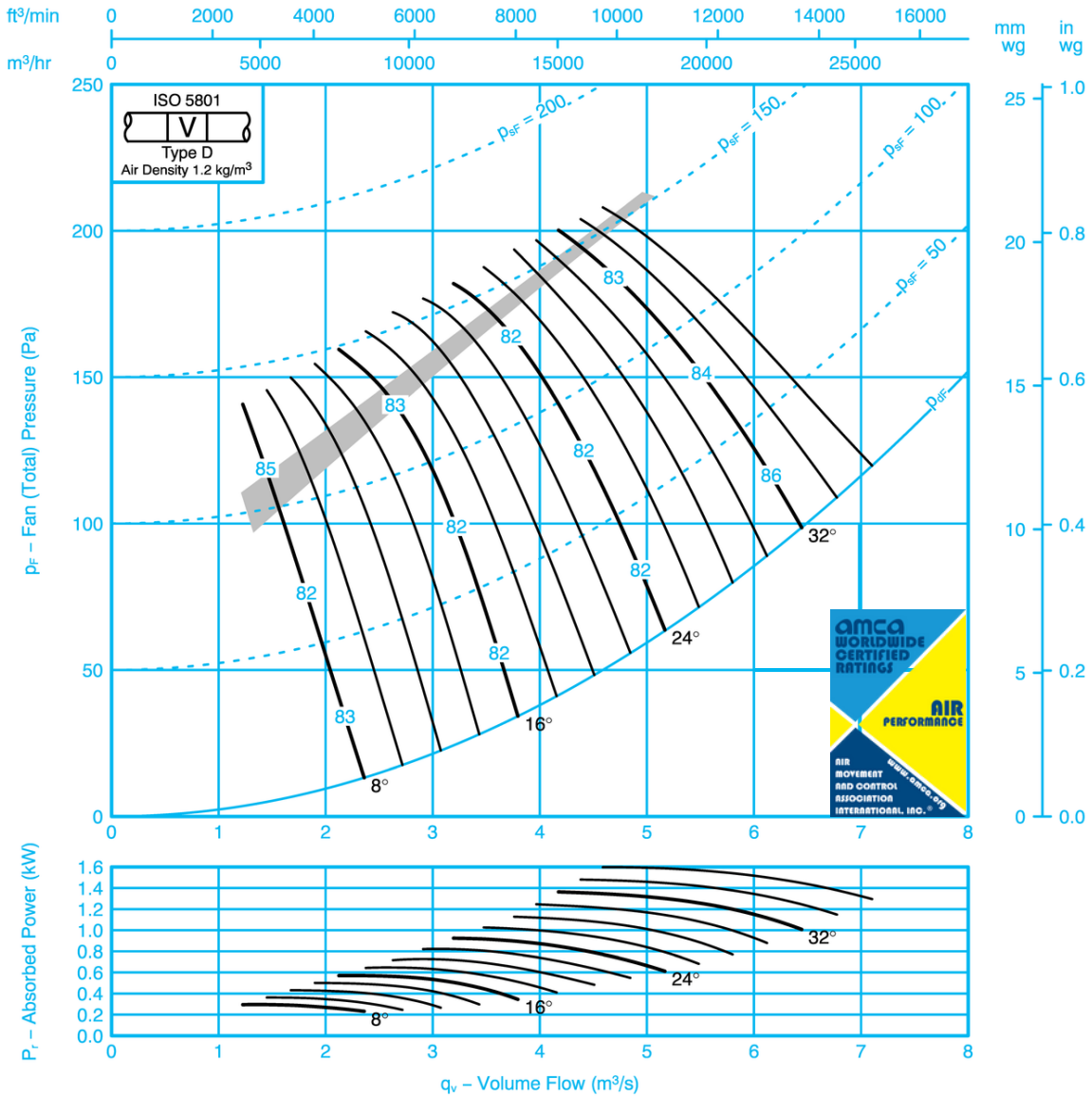

Sound Data ISO 5136

Single figures on performance curves are overall inlet sound power levels, derived from measurements taken in Woods laboratory specifically under ducted conditions. For sound power levels in eight octave bands, apply the following corrections to the overall level. Use upper corrections when operating point is above shaded area, or lower corrections when operating point is below shaded area.

Inlet Levels									Outlet Levels									
Pitch Angle	Octave Band Centre Frequency (Hz)								Pitch Angle	Octave Band Centre Frequency (Hz)								
	63	125	250	500	1k	2k	4k	8k		63	125	250	500	1k	2k	4k	8k	
8	-11	-8	-8	-4	-7	-14	-23	-33	8	-10	-7	-8	-6	-8	-7	-14	-21	-31
	-10	-9	-8	-6	-7	-8	-16	-25		-10	-8	-8	-8	-7	-7	-15	-22	-24
16	-9	-10	-5	-6	-9	-15	-20	-28	16	-8	-10	-5	-6	-9	-15	-19	-26	
	-9	-7	-5	-8	-9	-13	-17	-25		-9	-7	-5	-9	-9	-12	-17	-23	
24-36	-8	-8	-7	-6	-9	-12	-15	-21	24-36	-7	-8	-7	-7	-9	-12	-15	-20	
	-8	-7	-6	-7	-10	-13	-17	-23		-7	-6	-6	-8	-10	-13	-16	-21	

SK11956

WAM_DC_00073GB_60HZ JM AEROFOIL
January 2024



FAN CODE: 80JM/20/6/3/...
 800mm 1110 rev/min 3 Blades 60 Hz

Performance Data ISO 5801

Performance shown is for installations type D – Ducted inlet, Ducted outlet. Performance ratings do not include the effects of appurtenances.

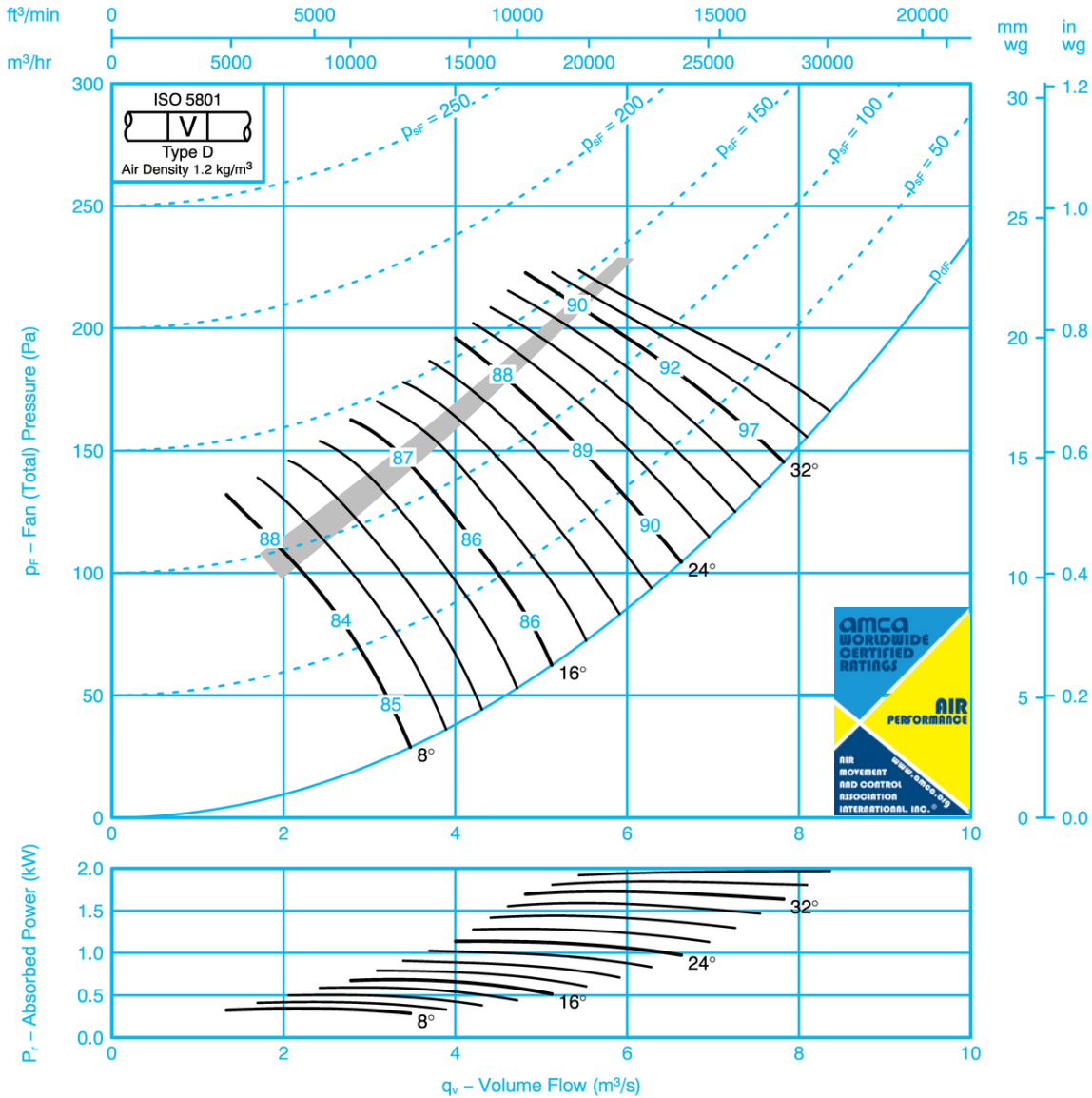

If it is intended to run this fan in reverse for other than emergency operation, please refer to Woods Air Movement.

Sound Data ISO 5136

Single figures on performance curves are overall inlet sound power levels, derived from measurements taken in Woods laboratory specifically under ducted conditions. For sound power levels in eight octave bands, apply the following corrections to the overall level. Use upper corrections when operating point is above shaded area, or lower corrections when operating point is below shaded area.

Inlet Levels								Outlet Levels									
Pitch Angle	Octave Band Centre Frequency (Hz)								Pitch Angle	Octave Band Centre Frequency (Hz)							
	63	125	250	500	1k	2k	4k	8k		63	125	250	500	1k	2k	4k	8k
8	-19	-9	-7	-10	-12	-21	-25	-33	8	-17	-9	-2	-10	-12	-20	-24	-30
	-10	-7	-7	-6	-7	-15	-19	-27		-8	-7	-7	-6	-7	-14	-18	-25
16	-7	-7	-5	-10	-9	-12	-16	-23	16	-6	-7	-5	-10	-9	-12	-15	-21
	-5	-5	-10	-12	-10	-14	-17	-23		-4	-5	-10	-12	-10	-14	-15	-21
24-36	-6	-8	-9	-10	-8	-9	-13	-18	24-36	-4	-8	-9	-10	-8	-9	-12	-16
	-4	-7	-9	-11	-11	-12	-16	-23		-3	-7	-9	-11	-11	-11	-15	-21

SK11957

WAM_DC_00073GB_60HZ JM AEROFOIL
 January 2024



FAN CODE: 80JM/20/6/6/...
 800mm 1110 rev/min 6 Blades 60 Hz

Performance Data ISO 5801

Performances shown is for installations type D – Ducted inlet, Ducted outlet. Performance ratings do not include the effects of appurtenances.

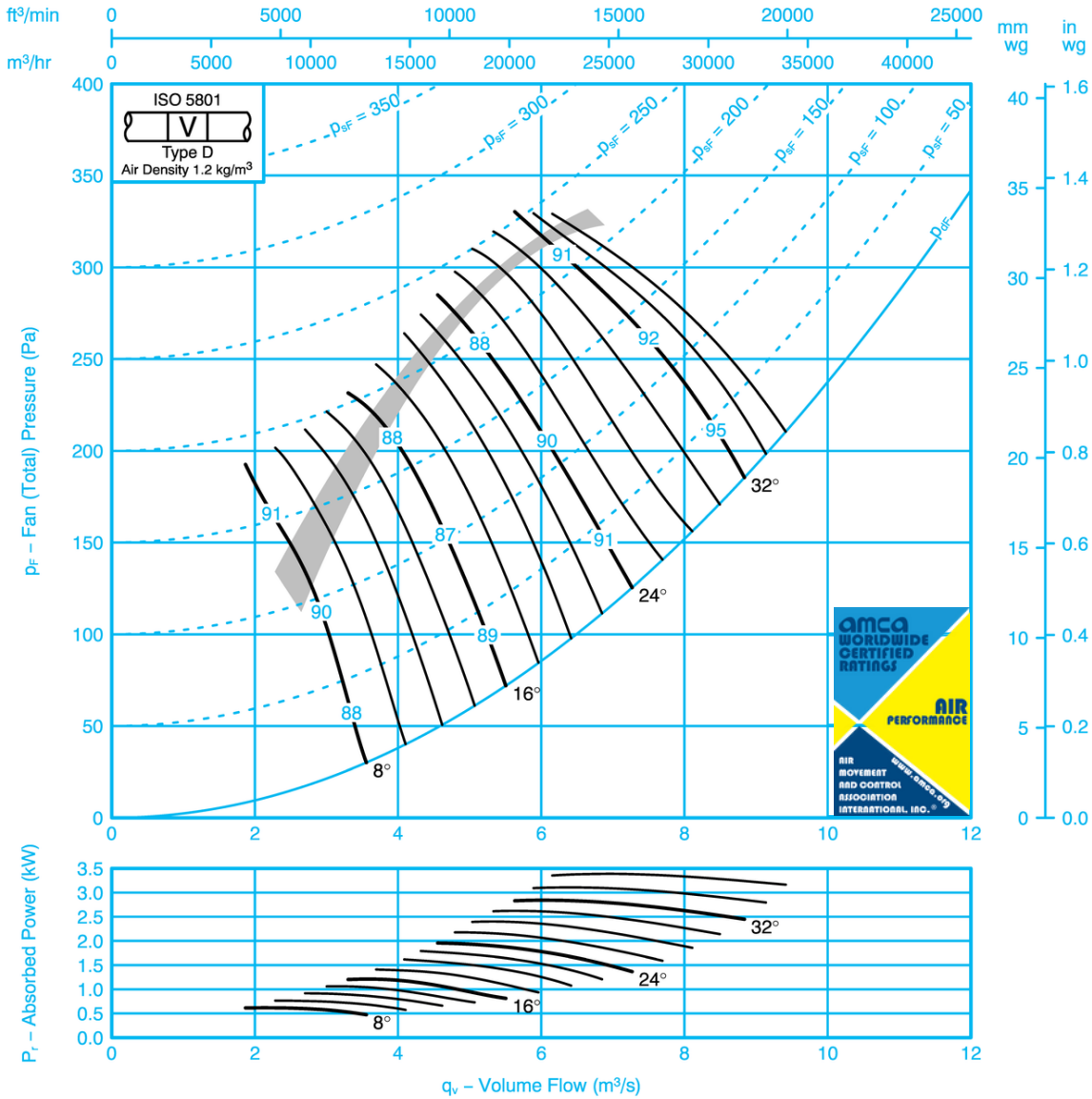

If it is intended to run this fan in reverse for other than emergency operation, please refer to Woods Air Movement.

Sound Data ISO 5136

Single figures on performance curves are overall inlet sound power levels, derived from measurements taken in Woods laboratory specifically under ducted conditions. For sound power levels in eight octave bands, apply the following corrections to the overall level. Use upper corrections when operating point is above shaded area, or lower corrections when operating point is below shaded area.

Inlet Levels								Outlet Levels									
Pitch Angle	Octave Band Centre Frequency (Hz)								Pitch Angle	Octave Band Centre Frequency (Hz)							
	63	125	250	500	1k	2k	4k	8k		63	125	250	500	1k	2k	4k	8k
8	-13	-6	-4	-8	-10	-20	-25	-31	8	-12	-6	-4	-8	-10	-19	-24	-29
	-15	-10	-6	-5	-6	-16	-20	-29		-15	-9	-6	-5	-6	-16	-20	-27
16	-14	-5	-3	-10	-11	-18	-25	-31	16	-14	-5	-3	-10	-11	-18	-24	-30
	-9	-6	-4	-11	-9	-15	-18	-24		-9	-6	-4	-11	-9	-14	-18	-23
24-36	-12	-6	-5	-9	-11	-12	-16	-23	24-36	-11	-6	-5	-9	-11	-12	-15	-22
	-7	-4	-8	-11	-11	-12	-17	-23		-7	-4	-8	-11	-11	-12	-16	-21

SK11958

WAM_DC_00073GB_60HZ JM AEROFOIL
 January 2024



FAN CODE: 80JM/25/6/6/...
 800mm 1110 rev/min 6 Blades 60 Hz

Performance Data ISO 5801

Performance shown is for installations type D – Ducted inlet, Ducted outlet. Performance ratings do not include the effects of appurtenances.

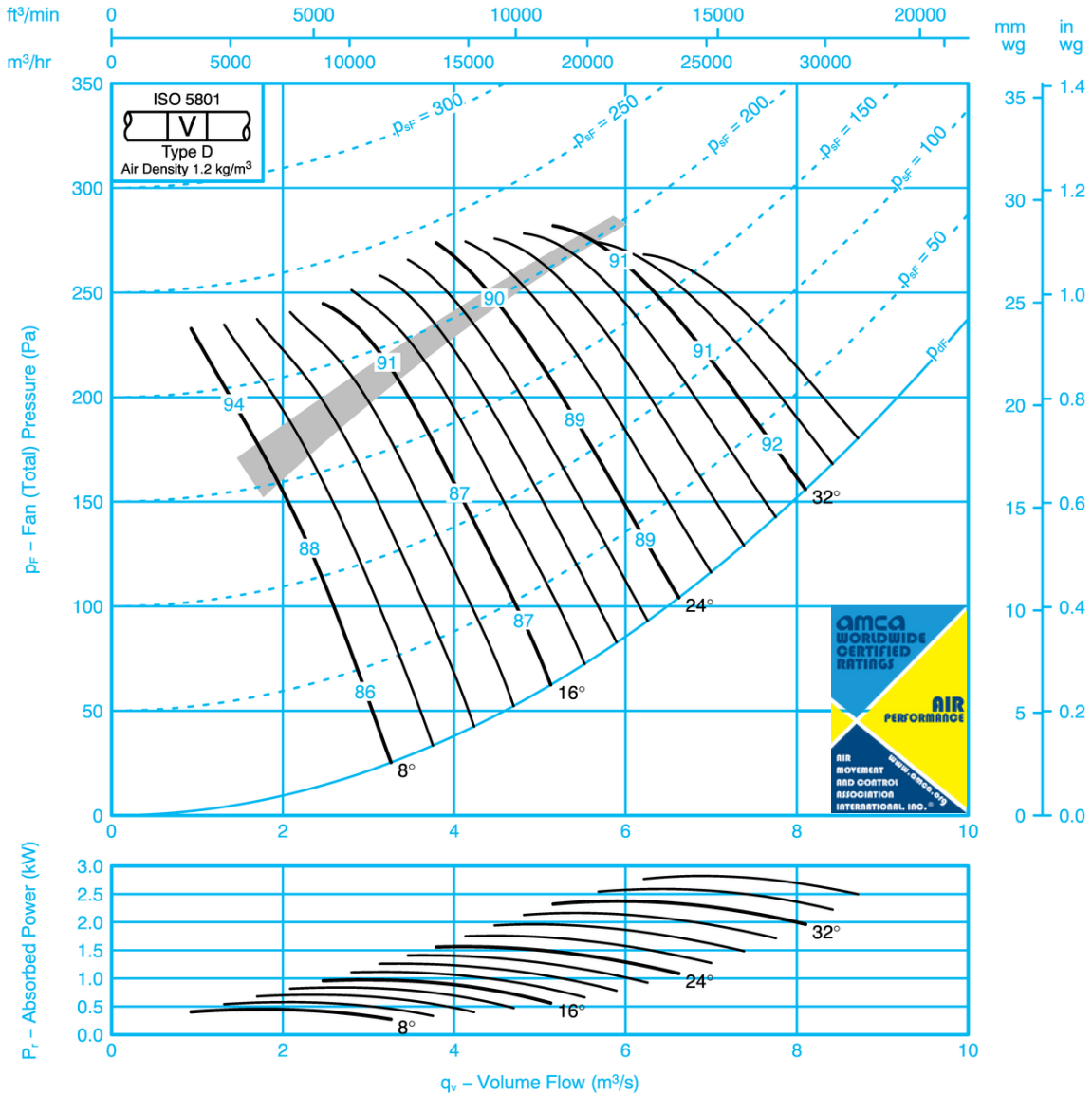

Sound Data ISO 5136

Single figures on performance curves are overall inlet sound power levels, derived from measurements taken in Woods laboratory specifically under ducted conditions. For sound power levels in eight octave bands, apply the following corrections to the overall level. Use upper corrections when operating point is above shaded area, or lower corrections when operating point is below shaded area.

Inlet Levels								Outlet Levels								
Pitch Angle	Octave Band Centre Frequency (Hz)							Pitch Angle	Octave Band Centre Frequency (Hz)							
	63	125	250	500	1k	2k	4k		8k	63	125	250	500	1k	2k	4k
8	-15	-14	-8	-4	-6	-14	-21	8	-14	-13	-8	-5	-6	-14	-20	-26
	-10	-13	-10	-6	-4	-9	-15		-10	-12	-10	-8	-5	-8	-14	-20
16	-8	-9	-10	-5	-6	-12	-18	16	-7	-9	-10	-6	-6	-12	-17	-23
	-5	-6	-8	-10	-11	-13	-17		-5	-6	-8	-10	-11	-13	-16	-20
24-36	-6	-7	-8	-8	-8	-13	-16	24-36	-5	-7	-8	-9	-8	-13	-15	-19
	-5	-7	-8	-8	-9	-14	-17		-5	-7	-8	-9	-9	-13	-16	-19

SK11960

WAM_DC_00073GB_60HZ JM AEROFOIL
 January 2024



FAN CODE: 80JM/25/6/9/...
800mm 1110 rev/min 9 Blades 60 Hz

Performance Data ISO 5801

Performances shown is for installation type D – Ducted inlet, Ducted outlet. Performance ratings do not include the effects of appurtenances.

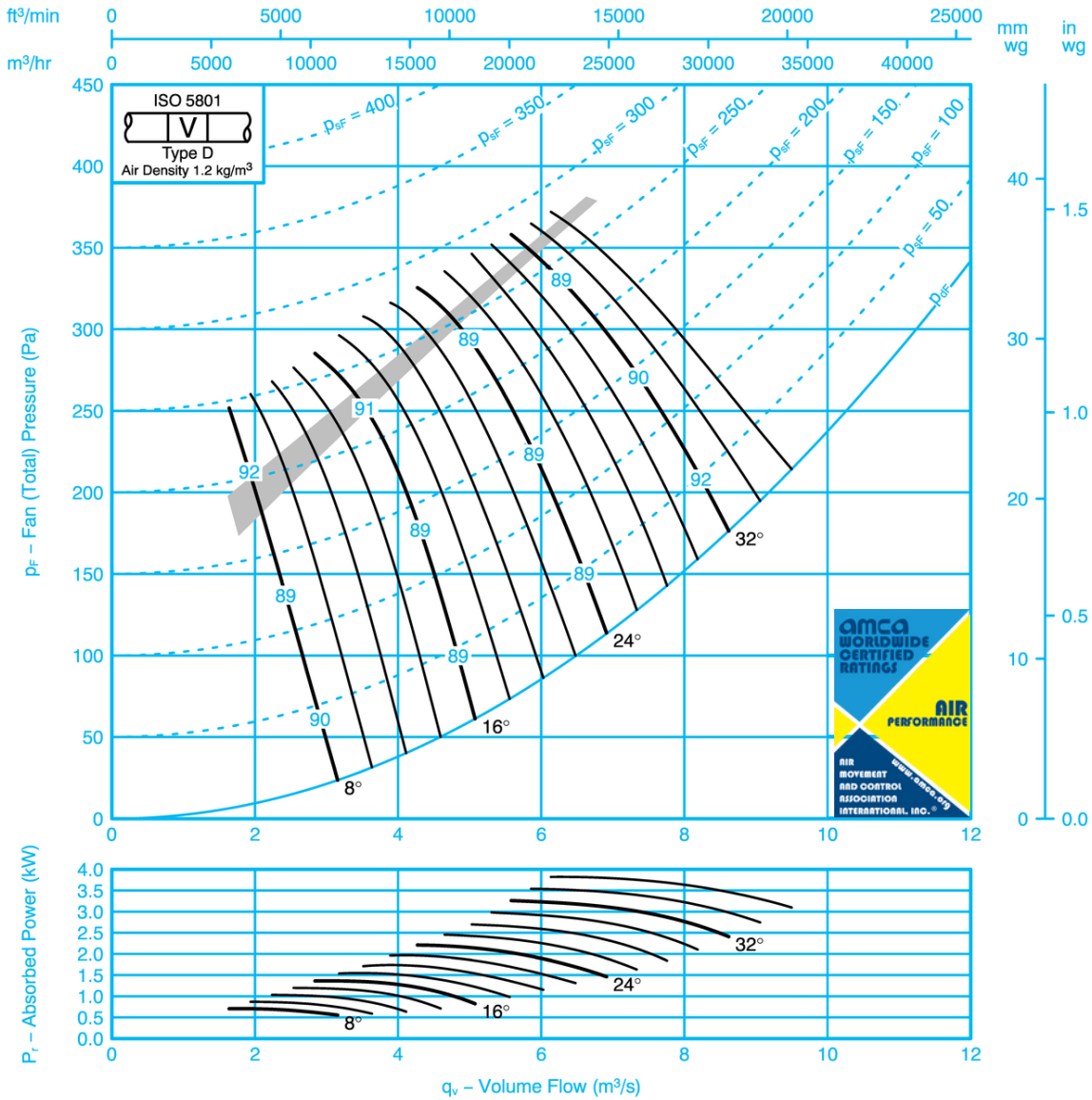

Sound Data ISO 5136

Single figures on performance curves are overall inlet sound power levels, derived from measurements taken in Woods laboratory specifically under ducted conditions. For sound power levels in eight octave bands, apply the following corrections to the overall level. Use upper corrections when operating point is above shaded area, or lower corrections when operating point is below shaded area.

Inlet Levels									Outlet Levels								
Pitch Angle	Octave Band Centre Frequency (Hz)								Pitch Angle	Octave Band Centre Frequency (Hz)							
	63	125	250	500	1k	2k	4k	8k		63	125	250	500	1k	2k	4k	8k
8	-11	-9	-9	-5	-6	-13	-21	-29	8	-9	-7	-9	-6	-6	-13	-20	-27
	-10	-10	-8	-7	-7	-8	-13	-23		-10	-9	-8	-8	-7	-7	-13	-21
16	-9	-11	-6	-6	-8	-14	-19	-25	16	-7	-11	-6	-6	-8	-14	-18	-23
	-8	-9	-5	-7	-8	-12	-16	-22		-8	-9	-5	-7	-8	-12	-16	-20
24-36	-7	-10	-7	-7	-7	-12	-15	-19	24-36	-6	-10	-7	-8	-8	-12	-14	-18
	-7	-9	-6	-7	-9	-13	-16	-21		-6	-8	-6	-8	-9	-13	-15	-19

SK11961

WAM_DC_00073GB_60HZ JM AEROFOIL
January 2024



FAN CODE: 80JM/20/4/3/...
 800mm 1730 rev/min 3 Blades 60 Hz

Performance Data ISO 5801

Performance shown is for installations type D – Ducted inlet, Ducted outlet. Performance ratings do not include the effects of appurtenances.

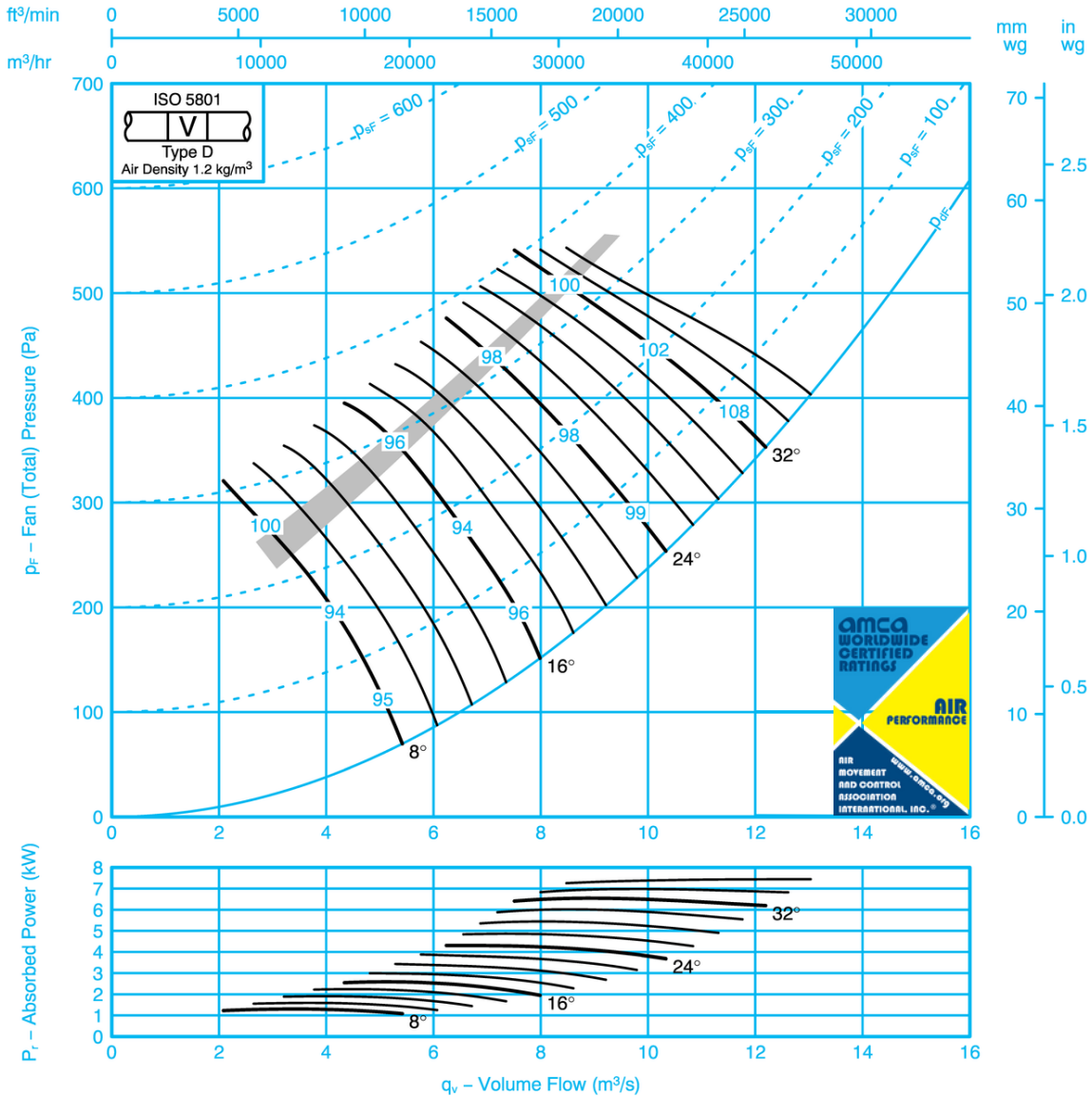

If it is intended to run this fan in reverse for other than emergency operation, please refer to Woods Air Movement.

Sound Data ISO 5136

Single figures on performance curves are overall inlet sound power levels, derived from measurements taken in Woods laboratory specifically under ducted conditions. For sound power levels in eight octave bands, apply the following corrections to the overall level. Use upper corrections when operating point is above shaded area, or lower corrections when operating point is below shaded area.

Inlet Levels								Outlet Levels									
Pitch Angle	Octave Band Centre Frequency (Hz)								Pitch Angle	Octave Band Centre Frequency (Hz)							
	63	125	250	500	1k	2k	4k	8k		63	125	250	500	1k	2k	4k	8k
8	-17	-19	-8	-2	-11	-15	-22	-28	8	-15	-18	-7	-2	-10	-14	-21	-25
	-8	-14	-8	-6	-7	-10	-16	-22		-7	-13	-8	-6	-7	-8	-15	-20
16	-7	-9	-7	-7	-12	-11	-13	-19	16	-6	-9	-7	-7	-12	-10	-11	-17
	-3	-9	-7	-12	-13	-14	-16	-20		-3	-8	-7	-12	-12	-13	-14	-18
24-36	-7	-7	-9	-10	-11	-7	-12	-15	24-36	-6	-6	-9	-10	-11	-7	-10	-13
	-5	-6	-8	-11	-14	-11	-15	-18		-4	-6	-8	-11	-14	-11	-14	-16

SK11962

WAM_DC_00073GB_60HZ JM AEROFOIL
 January 2024



Performance Data ISO 5801

Performance shown is for installations type D – Ducted inlet, Ducted outlet. Performance ratings do not include the effects of appurtenances.

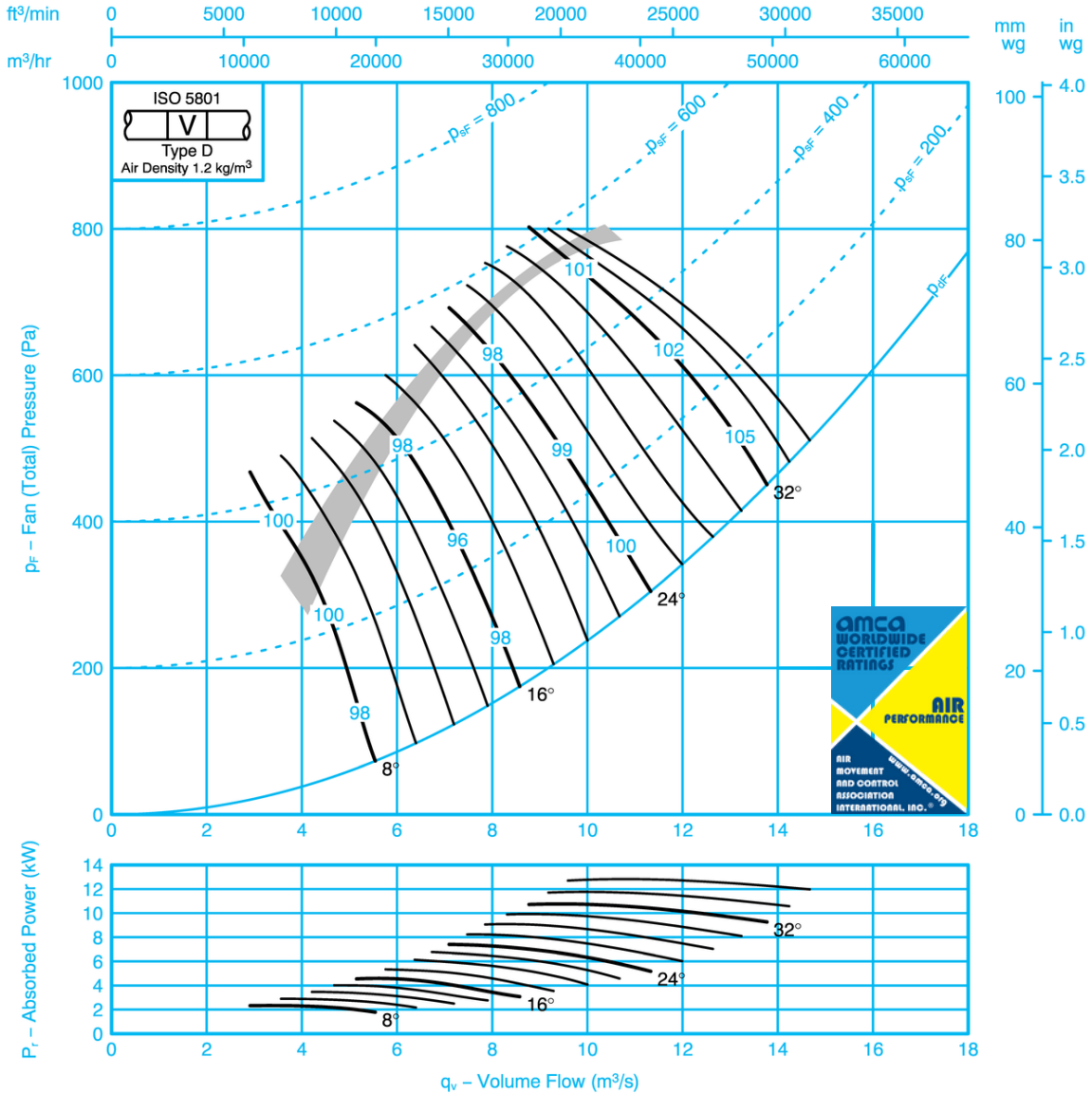

If it is intended to run this fan in reverse for other than emergency operation, please refer to Woods Air Movement.

Sound Data ISO 5136

Single figures on performance curves are overall inlet sound power levels, derived from measurements taken in Woods laboratory specifically under ducted conditions. For sound power levels in eight octave bands, apply the following corrections to the overall level. Use upper corrections when operating point is above shaded area, or lower corrections when operating point is below shaded area.

Inlet Levels								Outlet Levels									
Pitch Angle	Octave Band Centre Frequency (Hz)								Pitch Angle	Octave Band Centre Frequency (Hz)							
	63	125	250	500	1k	2k	4k	8k		63	125	250	500	1k	2k	4k	8k
8	-22	-13	-7	-5	-9	-13	-21	-27	8	-20	-11	-6	-4	-8	-12	-19	-24
	-21	-12	-9	-5	-6	-8	-17	-23		-21	-11	-9	-5	-5	-7	-17	-21
16	-20	-14	-6	-5	-11	-14	-19	-28	16	-18	-13	-4	-4	-10	-13	-17	-25
	-12	-7	-5	-9	-10	-11	-15	-21		-11	-6	-5	-9	-10	-10	-14	-19
24-36	-14	-10	-7	-5	-12	-10	-14	-17	24-36	-13	-10	-7	-5	-12	-10	-14	-16
	-10	-6	-5	-9	-12	-11	-15	-19		-9	-6	-5	-8	-12	-11	-14	-17



FAN CODE: 80JM/25/4/3/...
 800mm 1730 rev/min 3 Blades 60 Hz

Performance Data ISO 5801

Performances shown is for installations type D – Ducted inlet, Ducted outlet. Performance ratings do not include the effects of appurtenances.

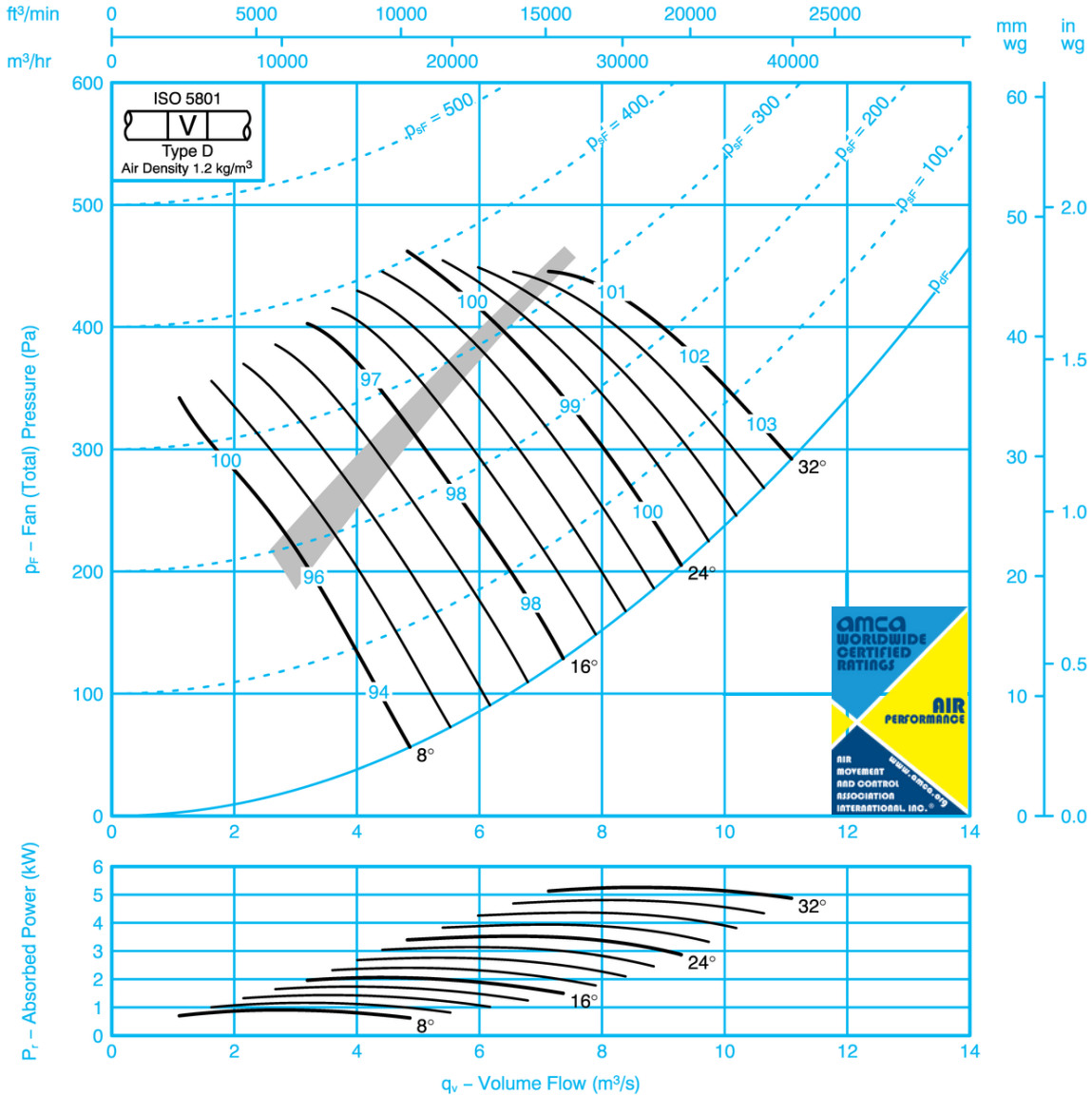

If it is intended to run this fan in reverse for other than emergency operation, please refer to Woods Air Movement.

Sound Data ISO 5136

Single figures on performance curves are overall inlet sound power levels, derived from measurements taken in Woods laboratory specifically under ducted conditions. For sound power levels in eight octave bands, apply the following corrections to the overall level. Use upper corrections when operating point is above shaded area, or lower corrections when operating point is below shaded area.

Inlet Levels								Outlet Levels									
Pitch Angle	Octave Band Centre Frequency (Hz)							Pitch Angle	Octave Band Centre Frequency (Hz)								
	63	125	250	500	1k	2k	4k		8k	63	125	250	500	1k	2k	4k	8k
8	-9	-11	-14	-6	-4	-10	-17	-23	8	-6	-10	-14	-8	-4	-10	-16	-20
	-4	-7	-12	-10	-10	-12	-15	-17		-2	-6	-12	-11	-11	-11	-14	-15
16	-4	-6	-11	-10	-11	-13	-16	-19	16	-4	-6	-11	-11	-11	-12	-15	-16
	-3	-5	-13	-13	-15	-17	-20	-22		-1	-5	-13	-14	-15	-16	-18	-19
24-32	-5	-6	-9	-10	-11	-13	-17	-20	24-32	-4	-5	-9	-10	-12	-13	-15	-18
	-5	-6	-10	-10	-11	-12	-16	-18		-3	-5	-10	-11	-11	-12	-14	-16

SK11964

WAM_DC_00073GB_60HZ JM AEROFOIL
 January 2024



FAN CODE: 80JM/25/4/6/...
 800mm 1730 rev/min 6 Blades 60 Hz

Performance Data ISO 5801

Performance shown is for installations type D – Ducted inlet, Ducted outlet. Performance ratings do not include the effects of appurtenances.

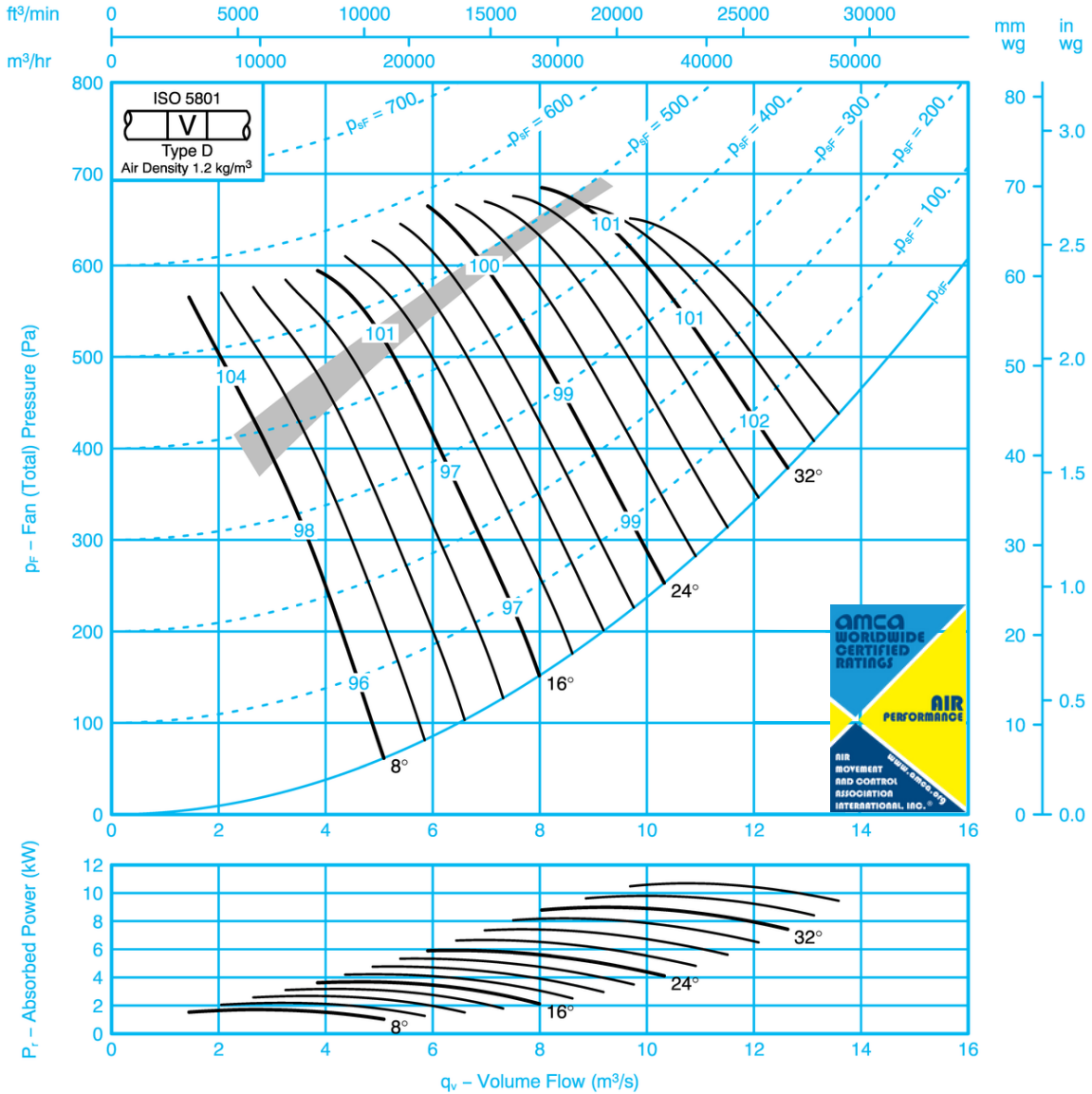

If it is intended to run this fan in reverse for other than emergency operation, please refer to Woods Air Movement.

Sound Data ISO 5136

Single figures on performance curves are overall inlet sound power levels, derived from measurements taken in Woods laboratory specifically under ducted conditions. For sound power levels in eight octave bands, apply the following corrections to the overall level. Use upper corrections when operating point is above shaded area, or lower corrections when operating point is below shaded area.

Inlet Levels									Outlet Levels								
Pitch Angle	Octave Band Centre Frequency (Hz)								Pitch Angle	Octave Band Centre Frequency (Hz)							
	63	125	250	500	1k	2k	4k	8k		63	125	250	500	1k	2k	4k	8k
8	-17	-15	-14	-6	-3	-8	-16	-23	8	-16	-13	-13	-8	-4	-8	-15	-20
	-15	-11	-13	-9	-5	-5	-11	-16		-15	-10	-13	-10	-6	-4	-10	-15
16	-12	-9	-9	-9	-5	-8	-14	-20	16	-11	-9	-9	-9	-5	-8	-13	-18
	-11	-5	-6	-9	-10	-12	-14	-18		-10	-5	-6	-9	-10	-11	-13	-16
24-36	-7	-7	-8	-9	-8	-10	-15	-17	24-36	-6	-7	-8	-9	-8	-10	-14	-16
	-7	-6	-8	-8	-9	-11	-15	-18		-7	-6	-8	-9	-9	-11	-14	-16

SK11965

WAM_DC_00073GB_60HZ JM AEROFOIL
 January 2024



FAN CODE: 80JM/25/4/9/...
800mm 1730 rev/min 9 Blades 60 Hz

Performance Data ISO 5801

Performances shown is for installations type D – Ducted inlet, Ducted outlet. Performance ratings do not include the effects of appurtenances.

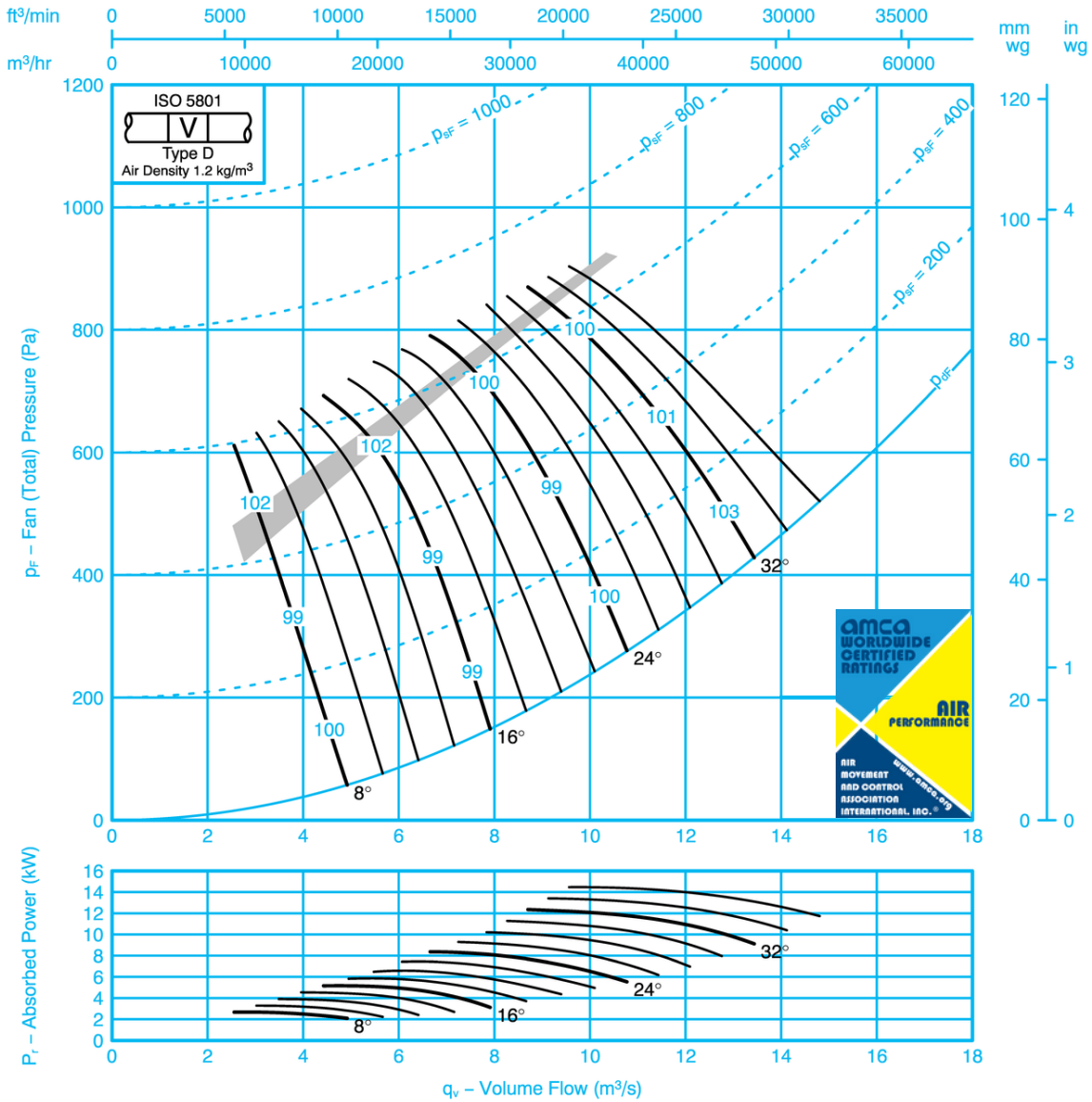

If it is intended to run this fan in reverse for other than emergency operation, please refer to Woods Air Movement.

Sound Data ISO 5136

Single figures on performance curves are overall inlet sound power levels, derived from measurements taken in Woods laboratory specifically under ducted conditions. For sound power levels in eight octave bands, apply the following corrections to the overall level. Use upper corrections when operating point is above shaded area, or lower corrections when operating point is below shaded area.

Inlet Levels									Outlet Levels								
Pitch Angle	Octave Band Centre Frequency (Hz)								Pitch Angle	Octave Band Centre Frequency (Hz)							
	63	125	250	500	1k	2k	4k	8k		63	125	250	500	1k	2k	4k	8k
8	-10	-11	-9	-8	-5	-8	-15	-24	8	-9	-11	-7	-9	-5	-7	-14	-22
	-11	-11	-10	-8	-7	-8	-9	-17		-10	-11	-9	-9	-7	-6	-8	-15
16	-7	-10	-10	-6	-7	-10	-16	-21	16	-6	-10	-10	-6	-7	-10	-15	-19
	-7	-10	-8	-6	-9	-10	-14	-18		-6	-10	-8	-7	-9	-9	-13	-17
24-36	-4	-11	-11	-9	-8	-11	-14	-17	24-36	-3	-11	-10	-9	-8	-11	-13	-16
	-6	-10	-8	-7	-9	-11	-15	-18		-5	-10	-8	-8	-9	-11	-14	-16

SK11966

WAM_DC_00073GB_60HZ JM AEROFOIL
January 2024



FAN CODE: 90JM/25/8/3/...
 900mm 830 rev/min 3 Blades 60 Hz

Performance Data ISO 5801

Performances shown is for installations type D – Ducted inlet, Ducted outlet. Performance ratings do not include the effects of appurtenances.

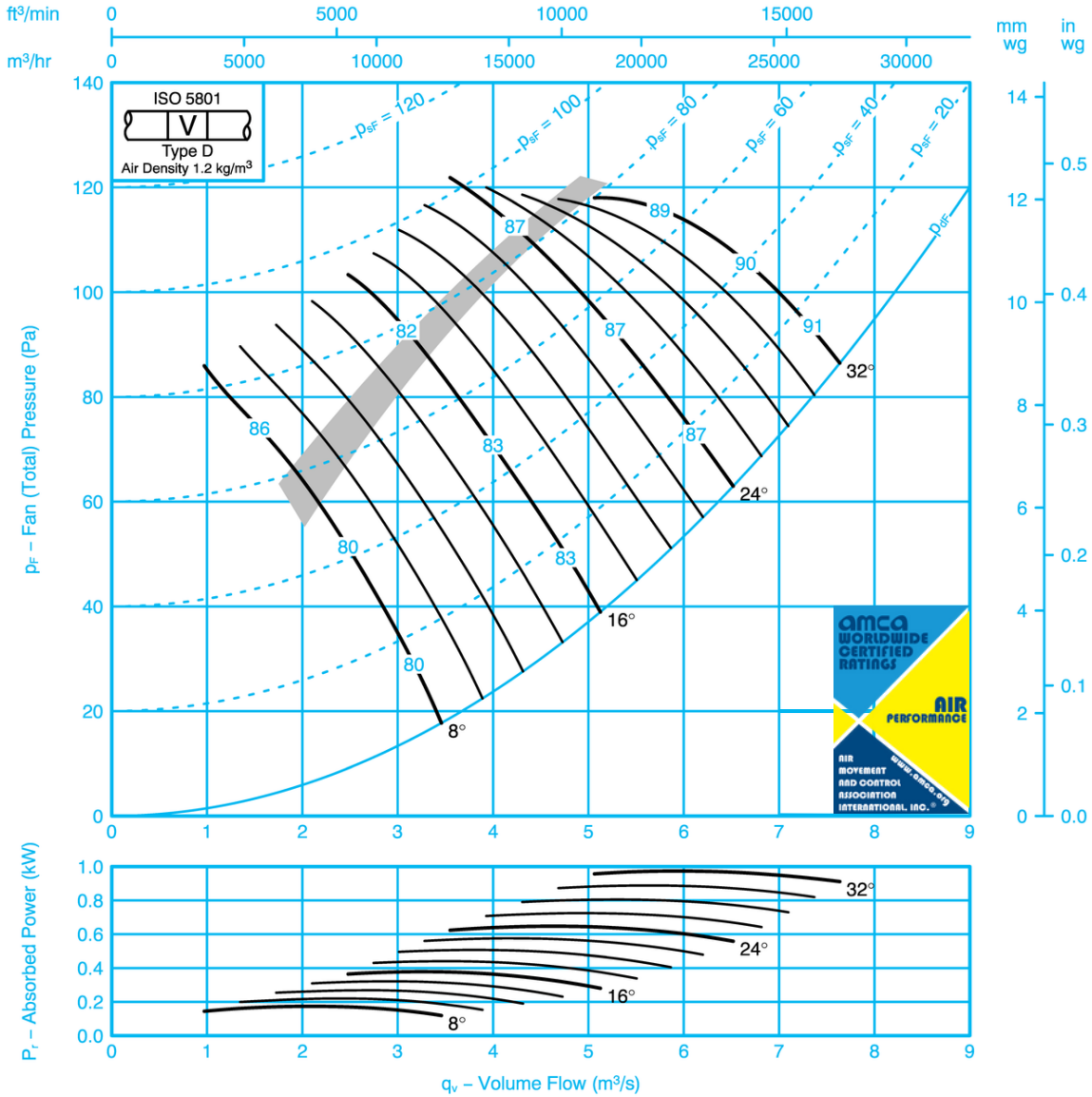

Sound Data ISO 5136

Single figures on performance curves are overall inlet sound power levels, derived from measurements taken in Woods laboratory specifically under ducted conditions. For sound power levels in eight octave bands, apply the following corrections to the overall level. Use upper corrections when operating point is above shaded area, or lower corrections when operating point is below shaded area.

Inlet Levels									Outlet Levels								
Pitch Angle	Octave Band Centre Frequency (Hz)								Pitch Angle	Octave Band Centre Frequency (Hz)							
	63	125	250	500	1k	2k	4k	8k		63	125	250	500	1k	2k	4k	8k
8	-14	-14	-6	-3	-9	-14	-21	-30	8	-12	-13	-6	-3	-9	-13	-20	-27
	-6	-10	-8	-7	-8	-11	-15	-22		-5	-10	-8	-7	-8	-9	-15	-20
16	-5	-9	-8	-8	-9	-12	-16	-21	16	-4	-9	-8	-8	-9	-12	-15	-19
	-3	-8	-9	-9	-11	-14	-17	-23		-3	-8	-9	-9	-11	-13	-16	-21
24-32	-4	-7	-8	-10	-11	-14	-17	-22	24-32	-3	-7	-8	-10	-11	-14	-16	-20
	-3	-8	-9	-10	-11	-13	-16	-20		-2	-8	-9	-10	-11	-12	-15	-18

SK11968

WAM_DC_00073GB_60HZ JM AEROFOIL
 January 2024



FAN CODE: 90JM/25/8/6/...
 900mm 830 rev/min 6 Blades 60 Hz

Performance Data ISO 5801

Performances shown is for installations type D – Ducted inlet, Ducted outlet. Performance ratings do not include the effects of appurtenances.

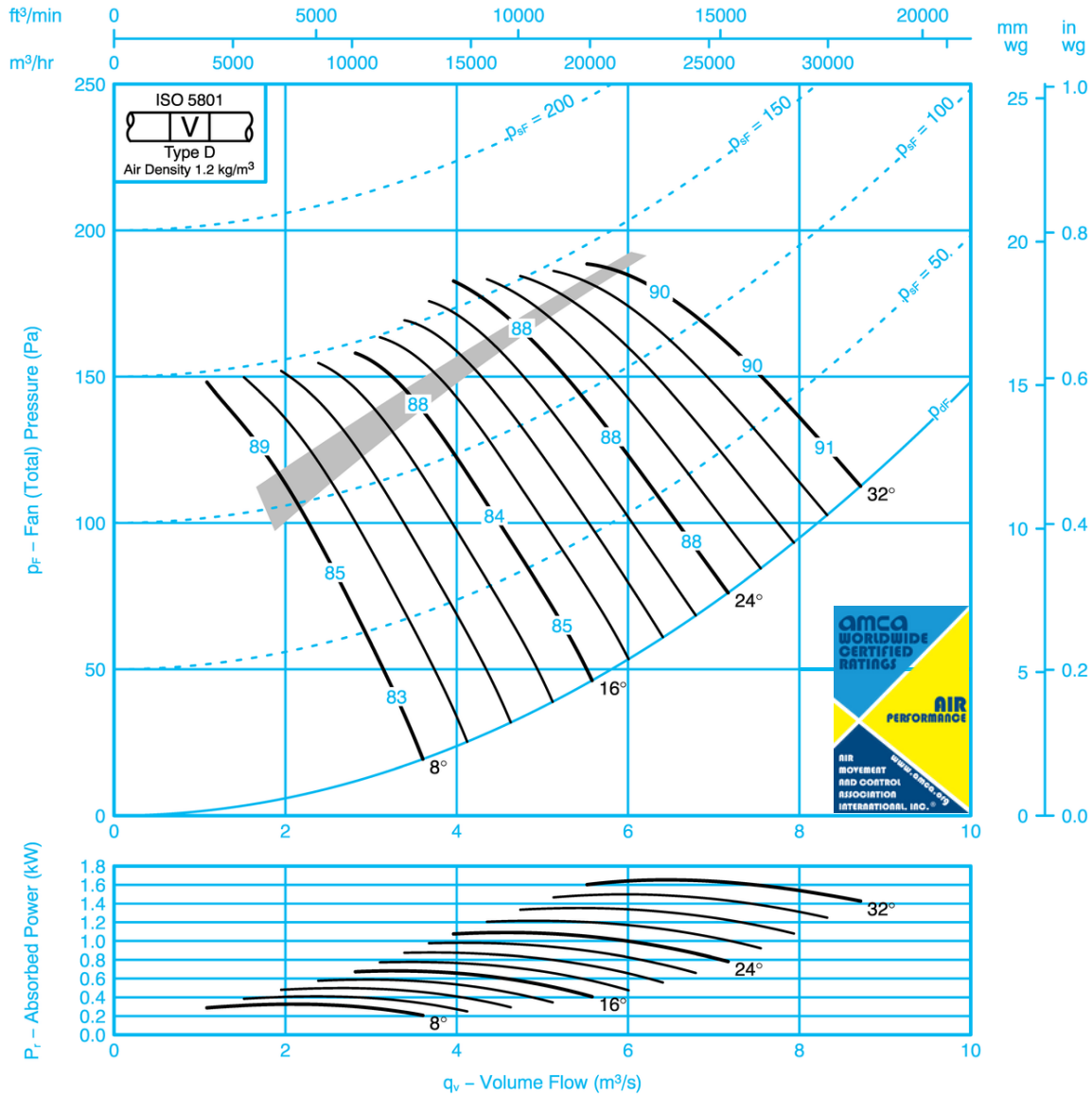

Sound Data ISO 5136

Single figures on performance curves are overall inlet sound power levels, derived from measurements taken in Woods laboratory specifically under ducted conditions. For sound power levels in eight octave bands, apply the following corrections to the overall level. Use upper corrections when operating point is above shaded area, or lower corrections when operating point is below shaded area.

Inlet Levels									Outlet Levels								
Pitch Angle	Octave Band Centre Frequency (Hz)								Pitch Angle	Octave Band Centre Frequency (Hz)							
	63	125	250	500	1k	2k	4k	8k		63	125	250	500	1k	2k	4k	8k
8	-17	-14	-6	-3	-8	-13	-22	-31	8	-15	-13	-6	-3	-8	-13	-21	-29
	-11	-12	-11	-5	-5	-8	-16	-24		-11	-12	-11	-5	-5	-7	-16	-23
16	-13	-12	-7	-3	-8	-12	-19	-29	16	-12	-12	-7	-3	-8	-11	-18	-27
	-7	-7	-8	-7	-9	-11	-16	-24		-6	-7	-8	-7	-9	-11	-15	-22
24-32	-7	-8	-7	-7	-8	-12	-16	-21	24-32	-6	-8	-7	-7	-8	-12	-15	-20
	-5	-7	-8	-8	-10	-12	-16	-21		-4	-7	-8	-8	-10	-12	-15	-20

SK11969

WAM_DC_00073GB_60HZ JM AEROFOIL
 January 2024



FAN CODE: 90JM/25/8/9/...
 900mm 830 rev/min 9 Blades 60 Hz

Performance Data ISO 5801

Performances shown is for installation type D – Ducted inlet, Ducted outlet. Performance ratings do not include the effects of appurtenances.

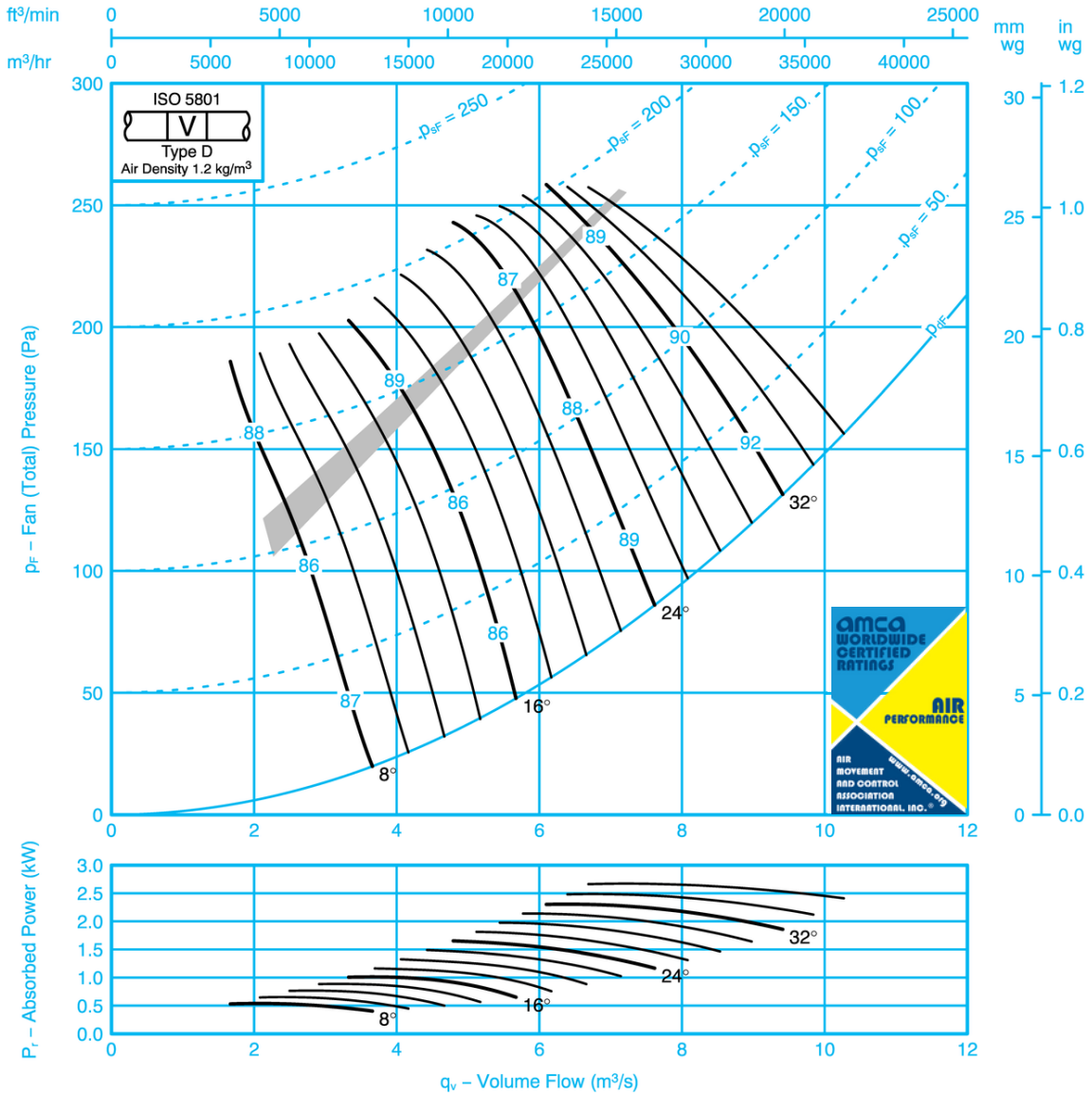

Sound Data ISO 5136

Single figures on performance curves are overall inlet sound power levels, derived from measurements taken in Woods laboratory specifically under ducted conditions. For sound power levels in eight octave bands, apply the following corrections to the overall level. Use upper corrections when operating point is above shaded area, or lower corrections when operating point is below shaded area.

Inlet Levels									Outlet Levels								
Pitch Angle	Octave Band Centre Frequency (Hz)								Pitch Angle	Octave Band Centre Frequency (Hz)							
	63	125	250	500	1k	2k	4k	8k		63	125	250	500	1k	2k	4k	8k
8	-16	-10	-8	-4	-6	-11	-20	-32	8	-15	-8	-8	-4	-6	-11	-19	-30
	-14	-8	-8	-7	-6	-8	-15	-25		-14	-8	-8	-7	-6	-7	-14	-23
16	-12	-10	-7	-5	-7	-11	-17	-25	16	-11	-10	-7	-5	-7	-11	-17	-24
	-9	-7	-7	-7	-8	-11	-16	-22		-9	-7	-7	-7	-8	-11	-15	-21
24-36	-8	-8	-7	-7	-8	-11	-15	-20	24-36	-7	-8	-7	-7	-8	-11	-14	-19
	-7	-7	-7	-8	-9	-12	-16	-21		-6	-7	-7	-8	-9	-12	-15	-20

SK11970

WAM_DC_00073GB_60HZ JM AEROFOIL
 January 2024



FAN CODE: 90JM/25/6/3/...
 900mm 1110 rev/min 3 Blades 60 Hz

Performance Data ISO 5801

Performance shown is for installations type D – Ducted inlet, Ducted outlet. Performance ratings do not include the effects of appurtenances.

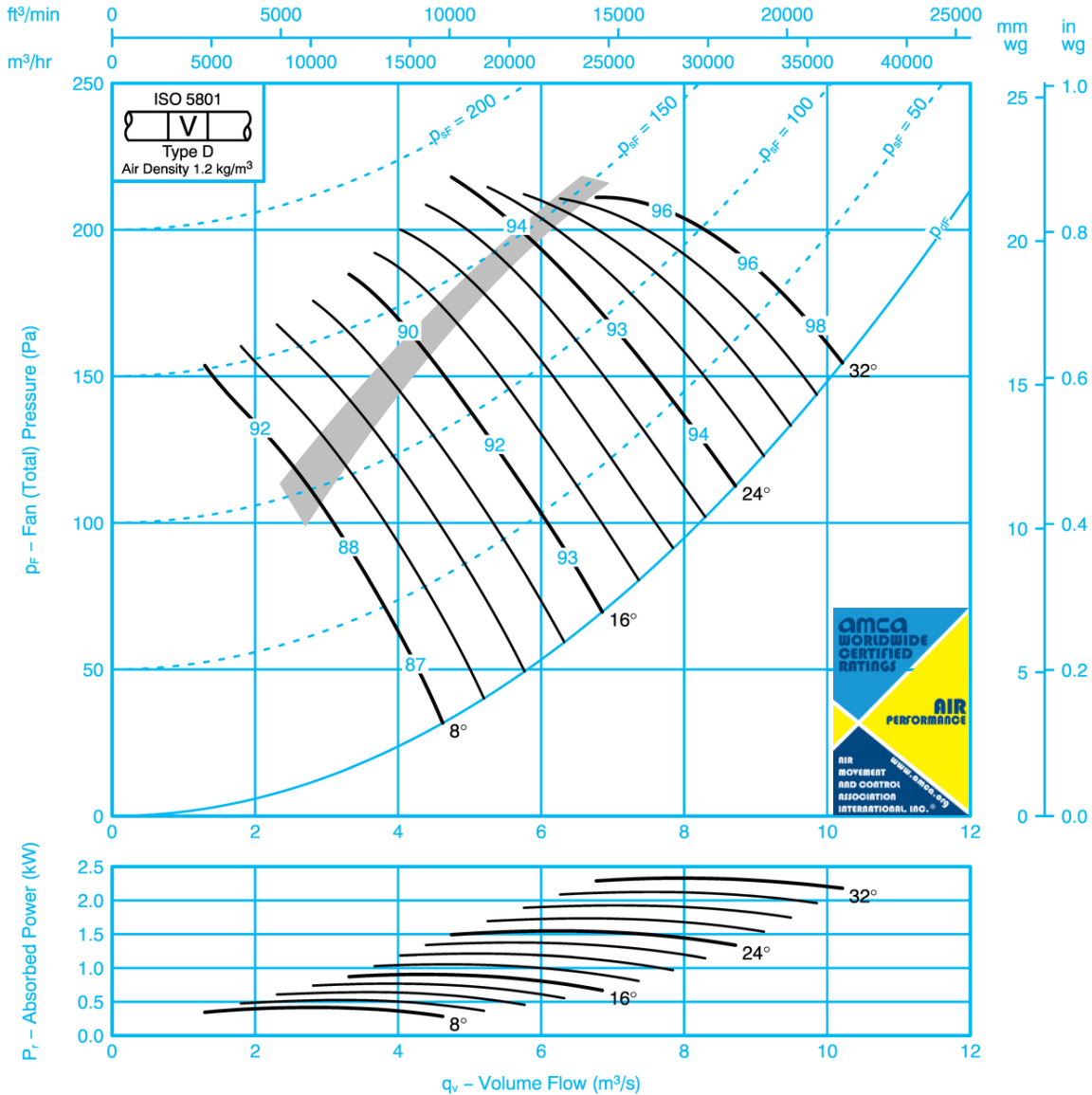

Sound Data ISO 5136

Single figures on performance curves are overall inlet sound power levels, derived from measurements taken in Woods laboratory specifically under ducted conditions. For sound power levels in eight octave bands, apply the following corrections to the overall level. Use upper corrections when operating point is above shaded area, or lower corrections when operating point is below shaded area.

Inlet Levels									Outlet Levels								
Pitch Angle	Octave Band Centre Frequency (Hz)								Pitch Angle	Octave Band Centre Frequency (Hz)							
	63	125	250	500	1k	2k	4k	8k		63	125	250	500	1k	2k	4k	8k
8	-13	-15	-8	-3	-6	-12	-20	-26	8	-11	-14	-8	-3	-6	-12	-18	-24
	-6	-10	-8	-8	-8	-11	-15	-20		-4	-10	-8	-8	-8	-9	-14	-18
16	-4	-9	-9	-9	-9	-11	-15	-20	16	-3	-9	-9	-9	-9	-11	-14	-17
	-3	-9	-10	-10	-11	-13	-16	-22		-3	-9	-10	-10	-11	-13	-15	-20
24-32	-4	-7	-9	-10	-11	-13	-17	-21	24-32	-3	-7	-9	-10	-11	-13	-16	-19
	-3	-9	-10	-11	-11	-13	-16	-19		-2	-9	-10	-11	-11	-12	-14	-17

SK11971

WAM_DC_00073GB_60HZ JM AEROFOIL
 January 2024



FAN CODE: 90JM/25/6/6/...
 900mm 1110 rev/min 6 Blades 60 Hz

Performance Data ISO 5801

Performances shown is for installations type D – Ducted inlet, Ducted outlet. Performance ratings do not include the effects of appurtenances.

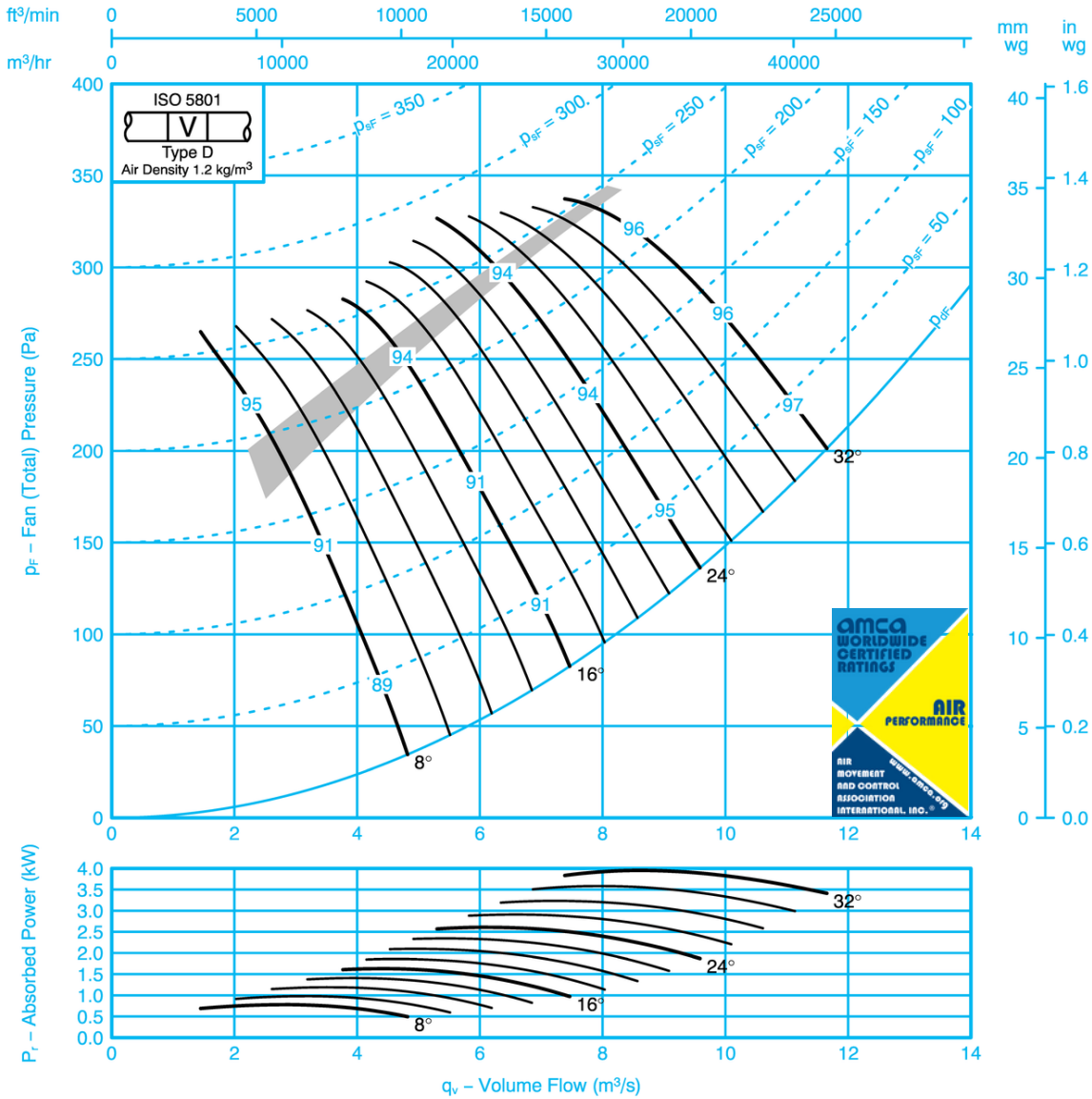

Sound Data ISO 5136

Single figures on performance curves are overall inlet sound power levels, derived from measurements taken in Woods laboratory specifically under ducted conditions. For sound power levels in eight octave bands, apply the following corrections to the overall level. Use upper corrections when operating point is above shaded area, or lower corrections when operating point is below shaded area.

Inlet Levels									Outlet Levels								
Pitch Angle	Octave Band Centre Frequency (Hz)								Pitch Angle	Octave Band Centre Frequency (Hz)							
	63	125	250	500	1k	2k	4k	8k		63	125	250	500	1k	2k	4k	8k
8	-15	-15	-8	-4	-6	-12	-20	-28	8	-14	-14	-8	-4	-6	-12	-20	-26
	-10	-13	-10	-6	-5	-7	-15	-21		-10	-13	-10	-6	-5	-6	-15	-20
16	-11	-12	-9	-4	-6	-11	-18	-26	16	-10	-12	-9	-4	-6	-11	-17	-24
	-6	-8	-8	-8	-9	-11	-15	-22		-5	-8	-8	-8	-9	-10	-15	-20
24-32	-6	-9	-8	-7	-8	-11	-15	-19	24-32	-5	-9	-8	-7	-8	-11	-15	-18
	-5	-8	-8	-9	-9	-12	-16	-19		-4	-8	-8	-9	-9	-12	-15	-18

SK11972

WAM_DC_00073GB_60HZ JM AEROFOIL
 January 2024



FAN CODE: 90JM/25/6/9/...
 900mm 1110 rev/min 9 Blades 60 Hz

Performance Data ISO 5801

Performances shown is for installation type D – Ducted inlet, Ducted outlet. Performance ratings do not include the effects of appurtenances.

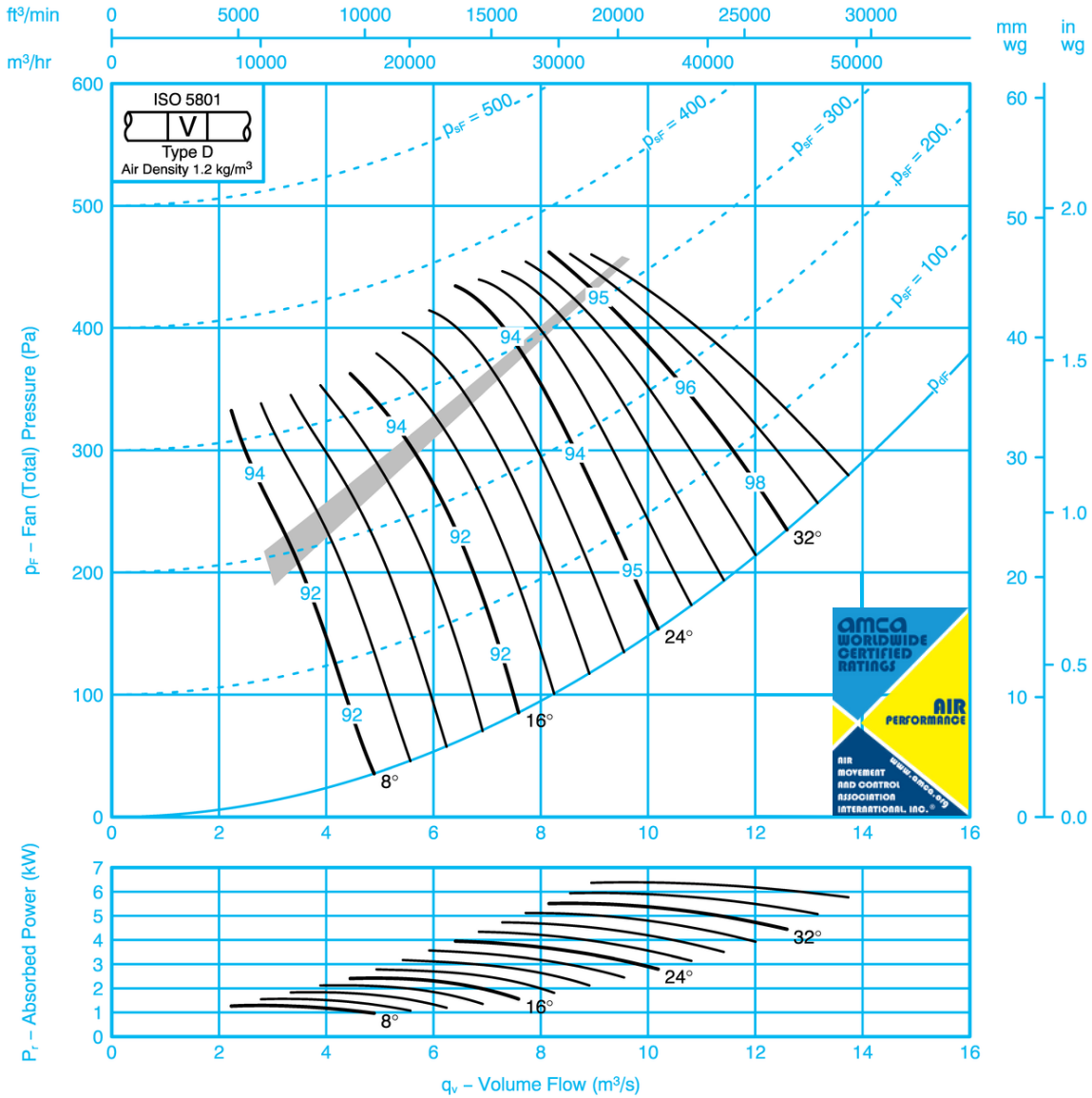

Sound Data ISO 5136

Single figures on performance curves are overall inlet sound power levels, derived from measurements taken in Woods laboratory specifically under ducted conditions. For sound power levels in eight octave bands, apply the following corrections to the overall level. Use upper corrections when operating point is above shaded area, or lower corrections when operating point is below shaded area.

Inlet Levels									Outlet Levels								
Pitch Angle	Octave Band Centre Frequency (Hz)								Pitch Angle	Octave Band Centre Frequency (Hz)							
	63	125	250	500	1k	2k	4k	8k		63	125	250	500	1k	2k	4k	8k
8	-16	-11	-10	-5	-5	-9	-18	-28	8	-14	-9	-9	-5	-5	-9	-18	-25
	-14	-10	-8	-7	-6	-7	-13	-22		-14	-9	-8	-7	-6	-9	-13	-20
16	-11	-12	-8	-5	-6	-10	-16	-22	16	-10	-12	-8	-5	-6	-10	-15	-20
	-9	-9	-6	-7	-7	-10	-14	-20		-8	-9	-6	-7	-7	-10	-14	-18
24-36	-8	-10	-7	-7	-8	-10	-14	-18	24-36	-6	-10	-7	-7	-8	-10	-13	-17
	-6	-8	-7	-8	-9	-12	-15	-19		-6	-8	-6	-8	-9	-12	-14	-18

SK11973

WAM_DC_00073GB_60HZ JM AEROFOIL
 January 2024



FAN CODE: 90JM/25/4/3/...
 900mm 1760 rev/min 3 Blades 60 Hz

Performance Data ISO 5801

Performance shown is for installations type D – Ducted inlet, Ducted outlet. Performance ratings do not include the effects of appurtenances.

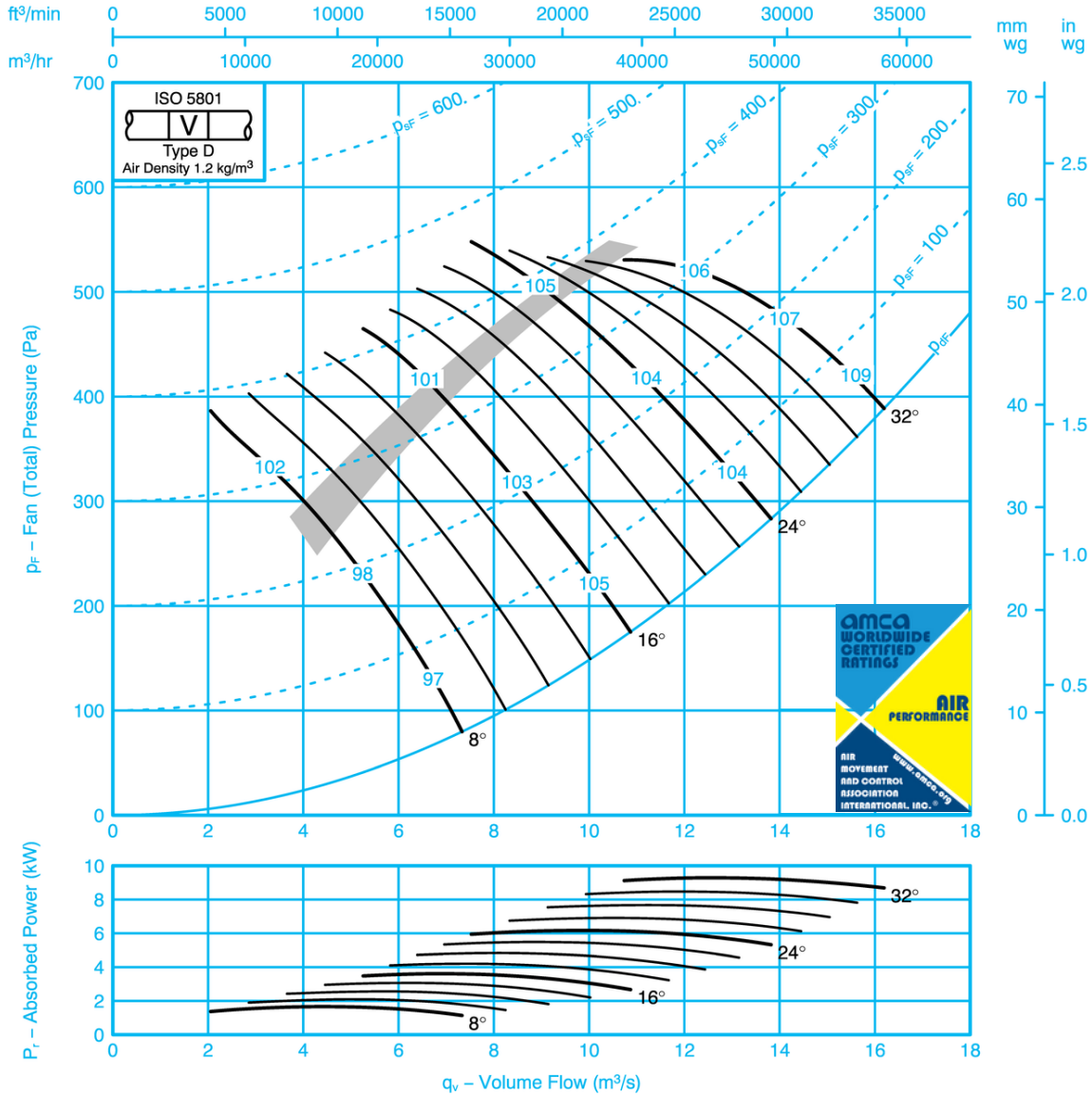

If it is intended to run this fan in reverse for other than emergency operation, please refer to Woods Air Movement.

Sound Data ISO 5136

Single figures on performance curves are overall inlet sound power levels, derived from measurements taken in Woods laboratory specifically under ducted conditions. For sound power levels in eight octave bands, apply the following corrections to the overall level. Use upper corrections when operating point is above shaded area, or lower corrections when operating point is below shaded area.

Inlet Levels									Outlet Levels											
Pitch Angle	Octave Band Centre Frequency (Hz)								Pitch Angle	Octave Band Centre Frequency (Hz)										
	63	125	250	500	1k	2k	4k	8k		63	125	250	500	1k	2k	4k	8k			
8	-14	-8	-15	-13	-10	-9	-11	-13	-18	8	-11	-6	-14	-11	-8	-3	-8	-9	-14	-15
16	-6	-9	-12	-11	-11	-12	-15	-19	-20	16	-4	-7	-10	-10	-11	-11	-13	-12	-14	-16
24-32	-7	-5	-9	-9	-12	-13	-15	-19	-18	24-32	-6	-5	-8	-9	-11	-12	-12	-14	-14	-17
	-6	-5	-10	-10	-12	-12	-15	-18			-5	-4	-10	-10	-12	-11	-13	-13	-15	

SK11975

WAM_DC_00073GB_60HZ JM AEROFOIL
 January 2024



FAN CODE: 90JM/25/4/6/...
 900mm 1760 rev/min 6 Blades 60 Hz

Performance Data ISO 5801

Performance shown is for installations type D – Ducted inlet, Ducted outlet. Performance ratings do not include the effects of appurtenances.

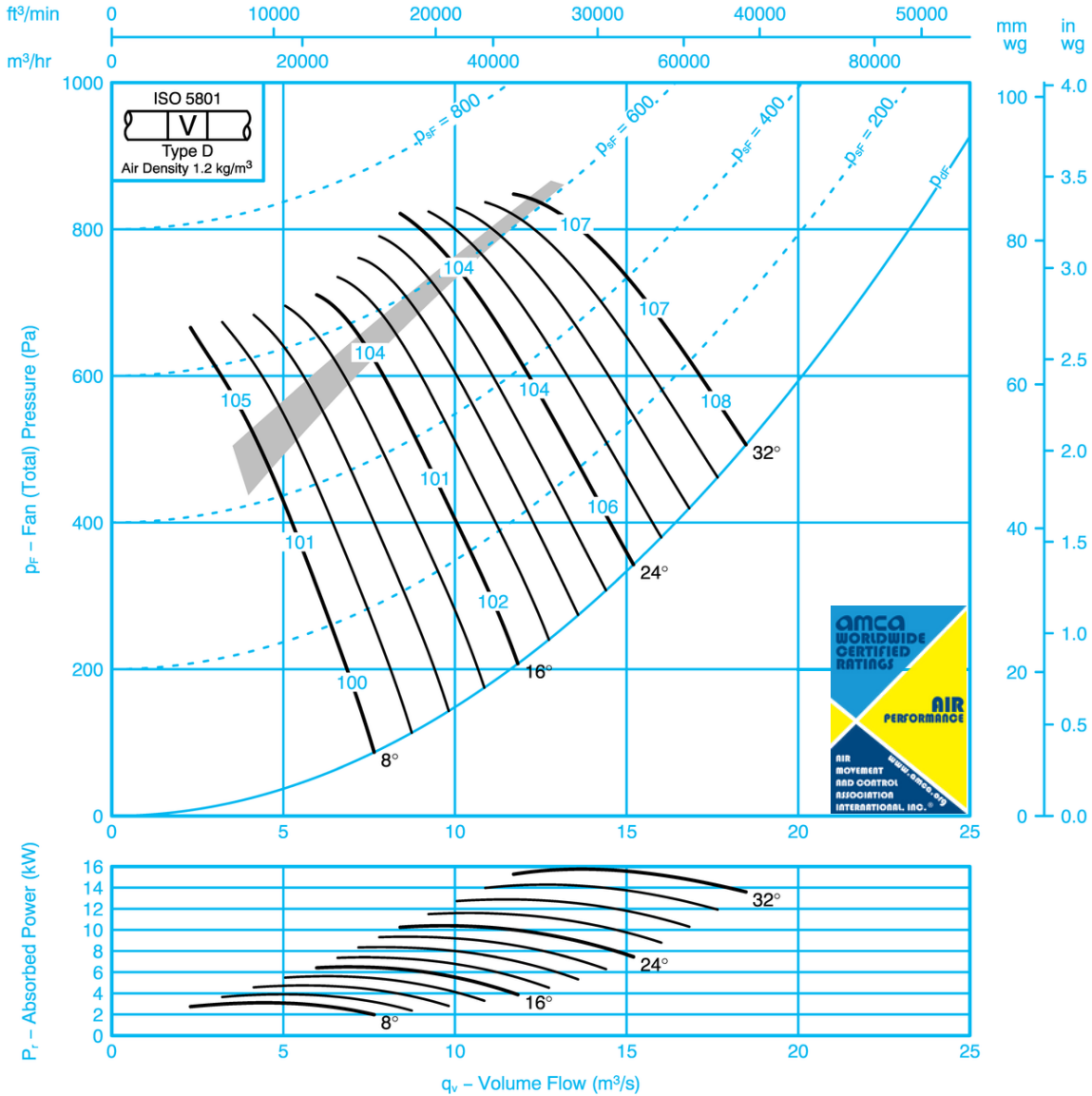

If it is intended to run this fan in reverse for other than emergency operation, please refer to Woods Air Movement.

Sound Data ISO 5136

Single figures on performance curves are overall inlet sound power levels, derived from measurements taken in Woods laboratory specifically under ducted conditions. For sound power levels in eight octave bands, apply the following corrections to the overall level. Use upper corrections when operating point is above shaded area, or lower corrections when operating point is below shaded area.

Inlet Levels									Outlet Levels									
Pitch Angle	Octave Band Centre Frequency (Hz)								Pitch Angle	Octave Band Centre Frequency (Hz)								
	63	125	250	500	1k	2k	4k	8k		63	125	250	500	1k	2k	4k	8k	
8	-15	-18	-14	-6	-4	-9	-15	-23	8	-13	-16	-13	-6	-4	-5	-8	-14	-20
	-12	-14	-14	-14	-7	-8	-12	-19		-10	-12	-12	-12	-5	-8	-9	-16	-16
16	-11	-14	-12	-8	-4	-9	-14	-20	16	-9	-14	-12	-7	-4	-9	-13	-18	-18
	-8	-9	-9	-10	-9	-11	-14	-18		-6	-8	-8	-9	-8	-10	-12	-16	-16
24-32	-7	-8	-9	-8	-8	-10	-13	-17	24-32	-6	-8	-9	-8	-8	-9	-13	-16	-16
	-6	-7	-9	-9	-10	-11	-14	-18		-6	-6	-8	-9	-10	-11	-13	-16	-16

SK11976

WAM_DC_00073GB_60HZ JM AEROFOIL
 January 2024



Performance Data ISO 5801

Performance shown is for installations type D – Ducted inlet, Ducted outlet. Performance ratings do not include the effects of appurtenances.

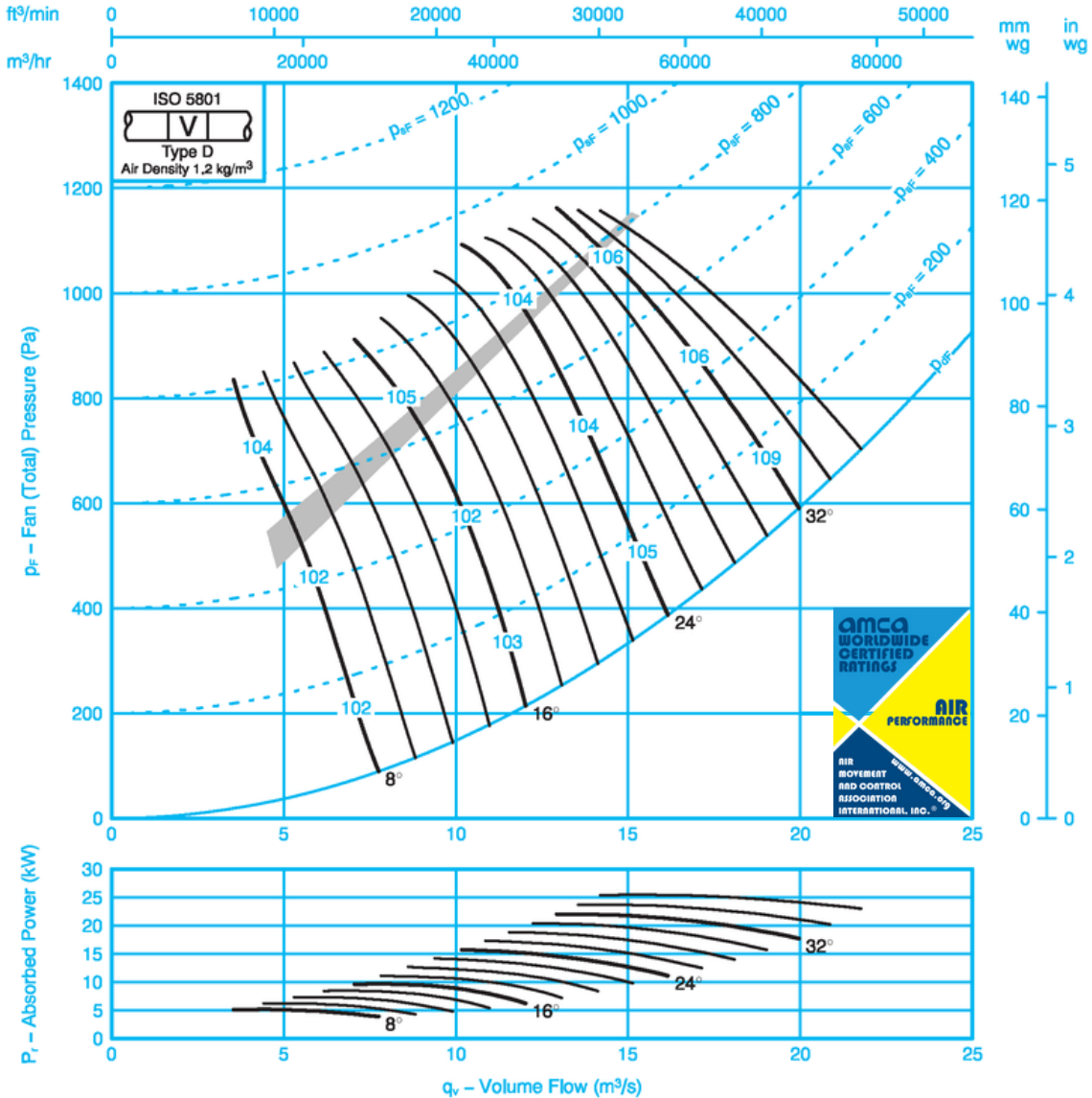

If it is intended to run this fan in reverse for other than emergency operation, please refer to Woods Air Movement.

Sound Data ISO 5136

Single figures on performance curves are overall inlet sound power levels, derived from measurements taken in Woods laboratory specifically under ducted conditions. For sound power levels in eight octave bands, apply the following corrections to the overall level. Use upper corrections when operating point is above shaded area, or lower corrections when operating point is below shaded area.

Inlet Levels									Outlet Levels								
Pitch Angle	Octave Band Centre Frequency (Hz)								Pitch Angle	Octave Band Centre Frequency (Hz)							
	63	125	250	500	1k	2k	4k	8k		63	125	250	500	1k	2k	4k	8k
8	-16	-17	-11	-9	-5	-7	-13	-21	8	-14	-16	-9	-8	-4	-6	-12	-18
	-14	-15	-9	-9	-7	-7	-9	-15		-14	-14	-8	-8	-7	-5	-8	-14
16	-12	-13	-11	-8	-6	-8	-13	-19	16	-10	-12	-10	-8	-5	-7	-11	-16
	-9	-11	-8	-8	-9	-9	-13	-17		-8	-10	-7	-7	-8	-8	-11	-15
24 - 36	-7	-10	-10	-9	-8	-9	-13	-16	24 - 36	-5	-10	-9	-8	-8	-9	-11	-15
	-7	-8	-8	-8	-9	-11	-14	-17		-6	-8	-8	-8	-9	-10	-13	-15

SK12470

WAM_DC_00073GB_60HZ JM AEROFOIL
January 2024



FAN CODE: 100JM/40/10/6/...
 1000mm 690 rev/min 6 Blades 60 Hz

Performance Data ISO 5801

Performance shown is for installations type D – Ducted inlet, Ducted outlet. Performance ratings do not include the effects of appurtenances.

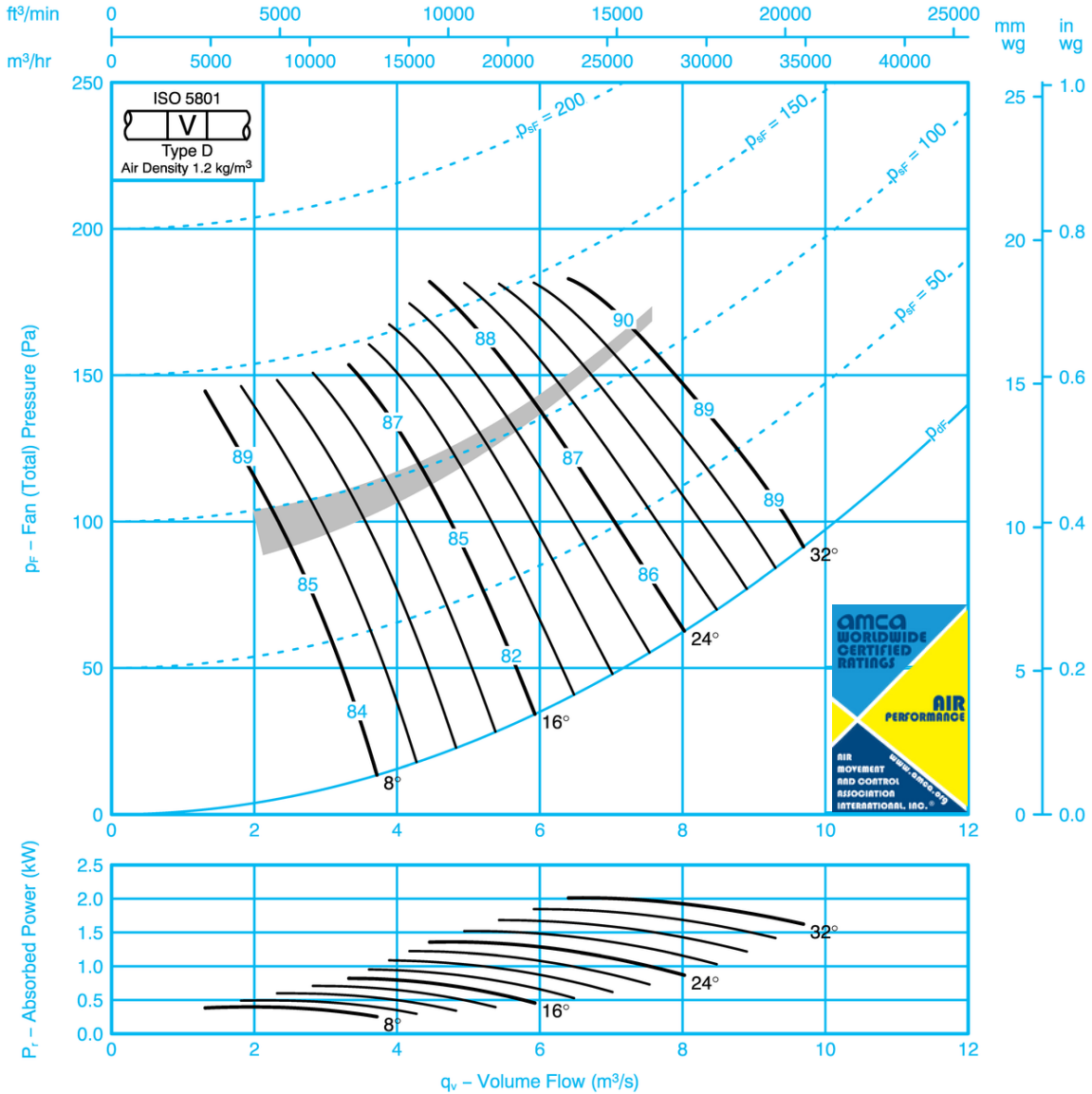

Sound Data ISO 5136

Single figures on performance curves are overall inlet sound power levels, derived from measurements taken in Woods laboratory specifically under ducted conditions. For sound power levels in eight octave bands, apply the following corrections to the overall level. Use upper corrections when operating point is above shaded area, or lower corrections when operating point is below shaded area.

Inlet Levels									Outlet Levels								
Pitch Angle	Octave Band Centre Frequency (Hz)								Pitch Angle	Octave Band Centre Frequency (Hz)							
	63	125	250	500	1k	2k	4k	8k		63	125	250	500	1k	2k	4k	8k
8	-8	-8	-5	-6	-12	-19	-26	-33	8	-6	-7	-5	-6	-12	-19	-26	-32
	-3	-8	-9	-8	-11	-15	-22	-29		-1	-7	-10	-8	-11	-15	-22	-28
16	-5	-6	-7	-9	-12	-16	-22	-29	16	-2	-5	-7	-9	-12	-16	-22	-28
	-4	-6	-8	-11	-13	-16	-23	-30		-1	-5	-9	-11	-12	-16	-23	-29
24-32	-4	-5	-9	-10	-11	-15	-19	-23	24-32	-2	-4	-10	-10	-11	-14	-19	-22
	-5	-5	-8	-10	-11	-17	-21	-24		-3	-4	-8	-10	-11	-16	-21	-23

SK11997

WAM_DC_00073GB_60HZ JM AEROFOIL
 January 2024



FAN CODE: 100JM/25/8/3/...
 1000mm 830 rev/min 3 Blades 60 Hz

Performance Data ISO 5801

Performance shown is for installations type D – Ducted inlet, Ducted outlet. Performance ratings do not include the effects of appurtenances.

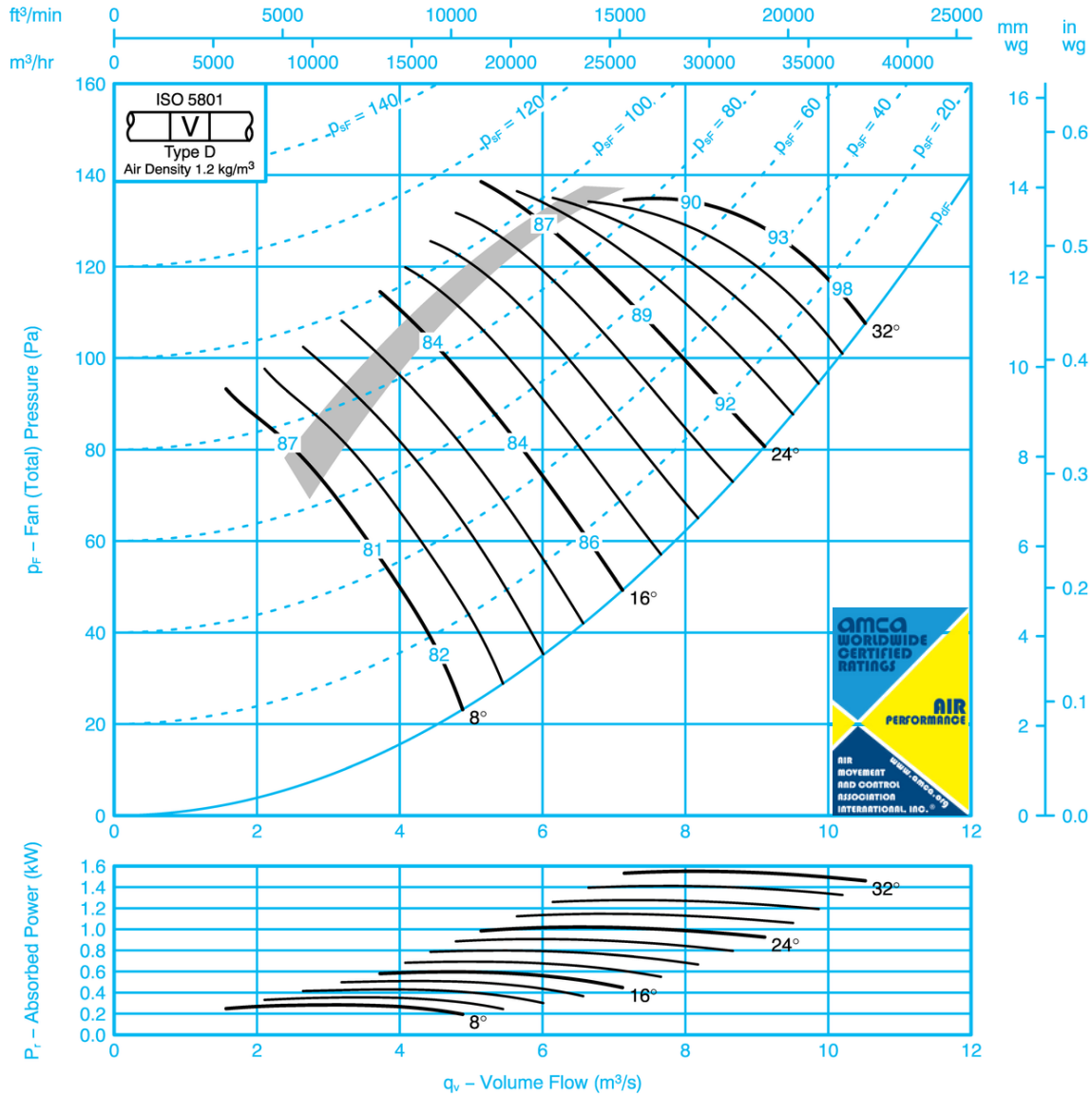

Sound Data ISO 5136

Single figures on performance curves are overall inlet sound power levels, derived from measurements taken in Woods laboratory specifically under ducted conditions. For sound power levels in eight octave bands, apply the following corrections to the overall level. Use upper corrections when operating point is above shaded area, or lower corrections when operating point is below shaded area.

Inlet Levels								Outlet Levels									
Pitch Angle	Octave Band Centre Frequency (Hz)								Pitch Angle	Octave Band Centre Frequency (Hz)							
	63	125	250	500	1k	2k	4k	8k		63	125	250	500	1k	2k	4k	8k
8	-15	-14	-6	-3	-8	-12	-21	-29	8	-13	-14	-6	-3	-8	-12	-20	-26
	-5	-11	-9	-7	-8	-10	-17	-24		-5	-11	-9	-7	-8	-9	-16	-22
16	-5	-9	-9	-7	-9	-10	-16	-22	16	-4	-9	-9	-7	-9	-10	-15	-19
	-3	-9	-10	-9	-11	-13	-17	-25		-3	-9	-10	-9	-11	-12	-16	-22
24-32	-4	-8	-9	-12	-12	-13	-17	-21	24-32	-3	-8	-9	-12	-12	-13	-16	-19
	-3	-9	-10	-12	-11	-13	-16	-20		-2	-9	-10	-12	-11	-12	-15	-17

SK11978

WAM_DC_00073GB_60HZ JM AEROFOIL
 January 2024



FAN CODE: 100JM/25/8/6/...
 1000mm 830 rev/min 6 Blades 60 Hz

Performance Data ISO 5801

Performance shown is for installations type D – Ducted inlet, Ducted outlet. Performance ratings do not include the effects of appurtenances.

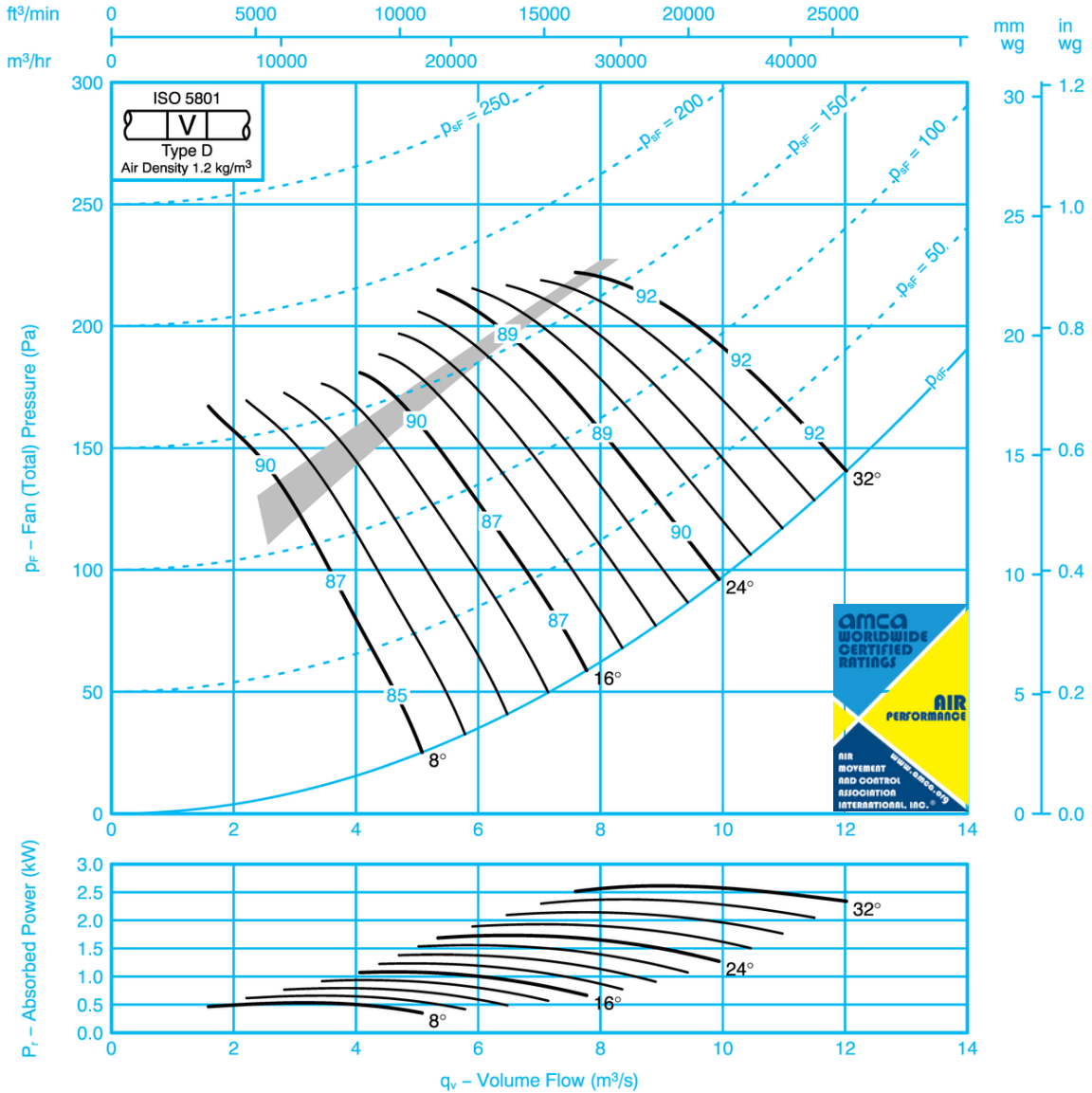

Sound Data ISO 5136

Single figures on performance curves are overall inlet sound power levels, derived from measurements taken in Woods laboratory specifically under ducted conditions. For sound power levels in eight octave bands, apply the following corrections to the overall level. Use upper corrections when operating point is above shaded area, or lower corrections when operating point is below shaded area.

Inlet Levels									Outlet Levels								
Pitch Angle	Octave Band Centre Frequency (Hz)								Pitch Angle	Octave Band Centre Frequency (Hz)							
	63	125	250	500	1k	2k	4k	8k		63	125	250	500	1k	2k	4k	8k
8	-18	-14	-6	-4	-8	-11	-22	-31	8	-16	-14	-6	-4	-8	-11	-21	-29
	-11	-11	-13	-6	-5	-7	-17	-25		-11	-11	-13	-6	-5	-6	-17	-23
16	-16	-15	-7	-3	-8	-12	-19	-30	16	-15	-15	-7	-3	-8	-12	-18	-28
	-8	-9	-9	-6	-8	-10	-16	-25		-7	-9	-9	-6	-8	-10	-15	-24
24-32	-7	-9	-7	-7	-8	-11	-16	-21	24-32	-6	-9	-7	-7	-8	-11	-15	-20
	-5	-8	-8	-9	-9	-11	-16	-20		-4	-8	-8	-9	-9	-11	-15	-18

SK11979

WAM_DC_00073GB_60HZ JM AEROFOIL
 January 2024



Performance Data ISO 5801

Performances shown is for installations type D – Ducted inlet, Ducted outlet. Performance ratings do not include the effects of appurtenances.

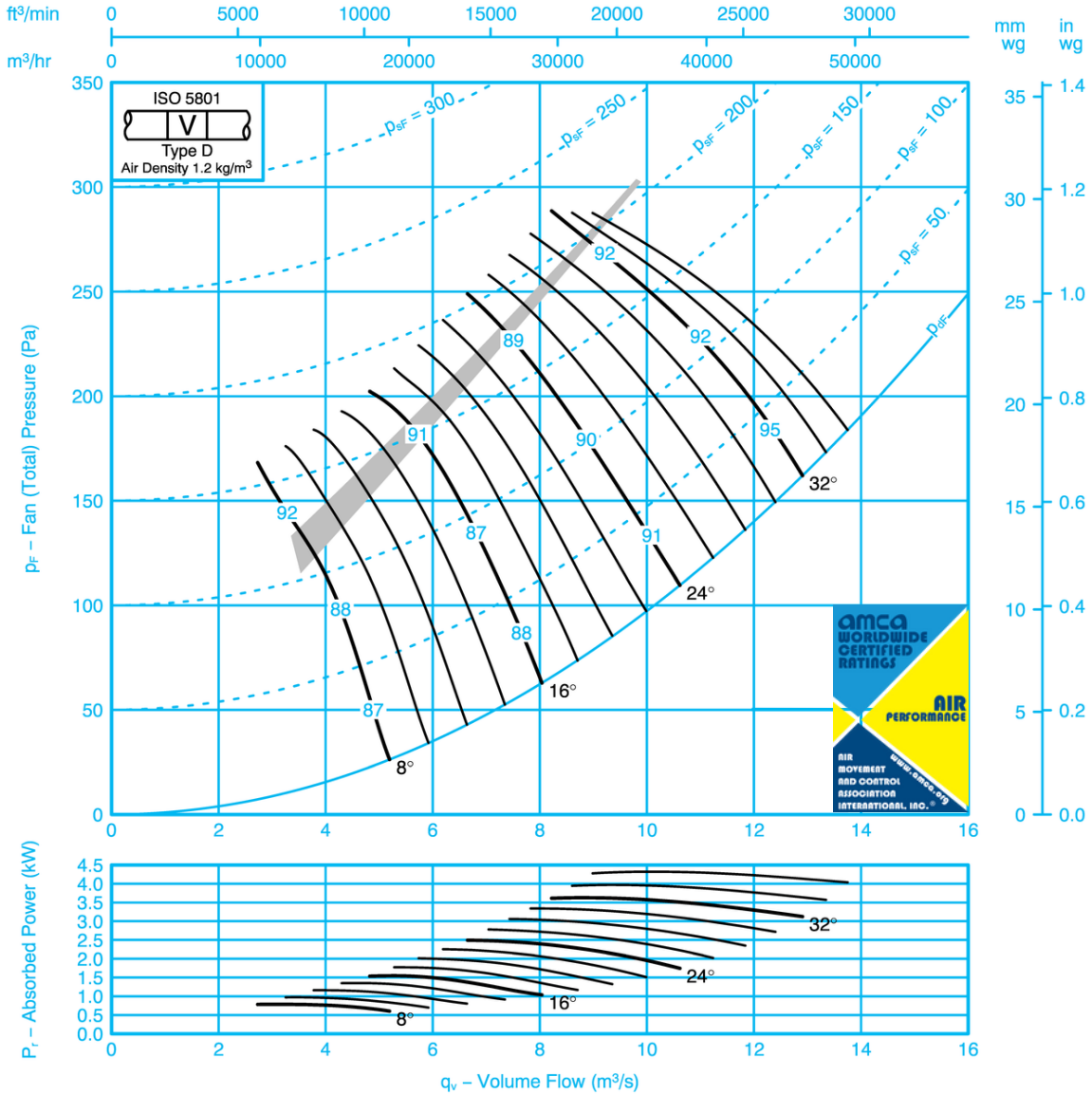

Sound Data ISO 5136

Single figures on performance curves are overall inlet sound power levels, derived from measurements taken in Woods laboratory specifically under ducted conditions. For sound power levels in eight octave bands, apply the following corrections to the overall level. Use upper corrections when operating point is above shaded area, or lower corrections when operating point is below shaded area.

Inlet Levels									Outlet Levels								
Pitch Angle	Octave Band Centre Frequency (Hz)								Pitch Angle	Octave Band Centre Frequency (Hz)							
	63	125	250	500	1k	2k	4k	8k		63	125	250	500	1k	2k	4k	8k
8	-22	-12	-9	-4	-6	-9	-17	-30	8	-21	-11	-9	-4	-6	-9	-17	-28
	-18	-8	-9	-7	-5	-8	-14	-24		-19	-7	-9	-7	-5	-6	-13	-23
16	-15	-12	-11	-4	-5	-9	-16	-23	16	-14	-12	-11	-4	-5	-9	-15	-22
	-10	-7	-8	-7	-7	-10	-14	-20		-10	-7	-8	-7	-7	-10	-14	-18
24-36	-8	-8	-8	-8	-7	-10	-14	-19	24-36	-7	-8	-8	-8	-7	-10	-14	-18
	-6	-7	-8	-9	-9	-11	-16	-20		-5	-6	-8	-9	-9	-11	-15	-18

SK11980

WAM_DC_00073GB_60HZ JM AEROFOIL
January 2024



Performance Data ISO 5801

Performance shown is for installations type D – Ducted inlet, Ducted outlet. Performance ratings do not include the effects of appurtenances.

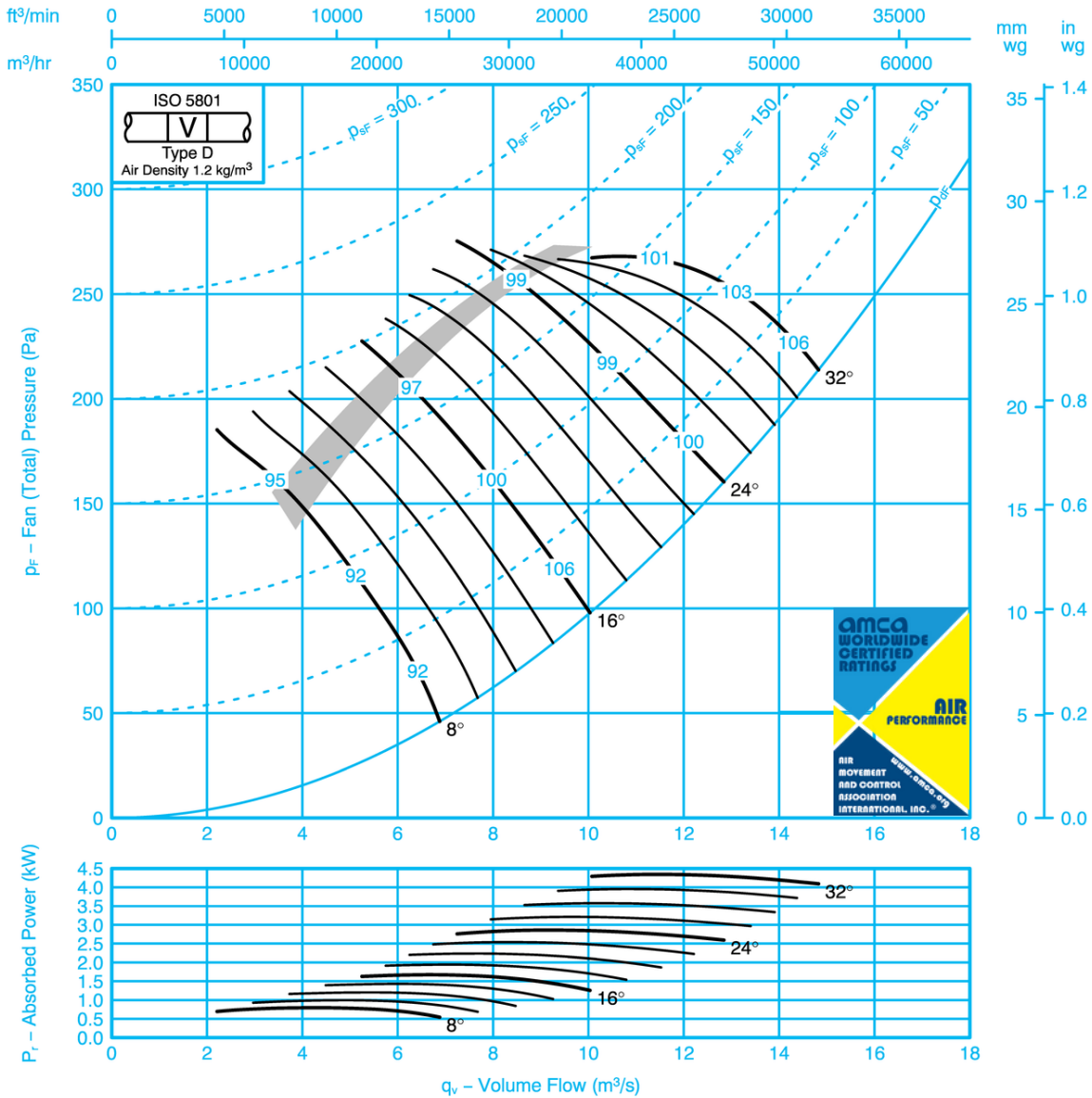

If it is intended to run this fan in reverse for other than emergency operation, please refer to Woods Air Movement.

Sound Data ISO 5136

Single figures on performance curves are overall inlet sound power levels, derived from measurements taken in Woods laboratory specifically under ducted conditions. For sound power levels in eight octave bands, apply the following corrections to the overall level. Use upper corrections when operating point is above shaded area, or lower corrections when operating point is below shaded area.

Inlet Levels									Outlet Levels								
Pitch Angle	Octave Band Centre Frequency (Hz)								Pitch Angle	Octave Band Centre Frequency (Hz)							
	63	125	250	500	1k	2k	4k	8k		63	125	250	500	1k	2k	4k	8k
8	-10	-16	-7	-5	-6	-11	-20	-26	8	-9	-15	-7	-5	-6	-10	-19	-23
	-3	-10	-10	-9	-9	-11	-18	-23		-3	-10	-10	-10	-9	-10	-17	-21
16	-2	-11	-12	-11	-11	-12	-18	-23	16	-1	-11	-12	-11	-11	-12	-17	-21
	-2	-9	-13	-11	-13	-14	-19	-26		-1	-9	-13	-11	-13	-14	-18	-23
24-32	-4	-8	-9	-11	-12	-13	-16	-19	24-32	-3	-7	-9	-11	-12	-13	-15	-17
	-2	-9	-11	-12	-12	-13	-16	-18		-1	-9	-11	-12	-12	-13	-15	-16



Performance Data ISO 5801

Performance shown is for installations type D – Ducted inlet, Ducted outlet. Performance ratings do not include the effects of appurtenances.

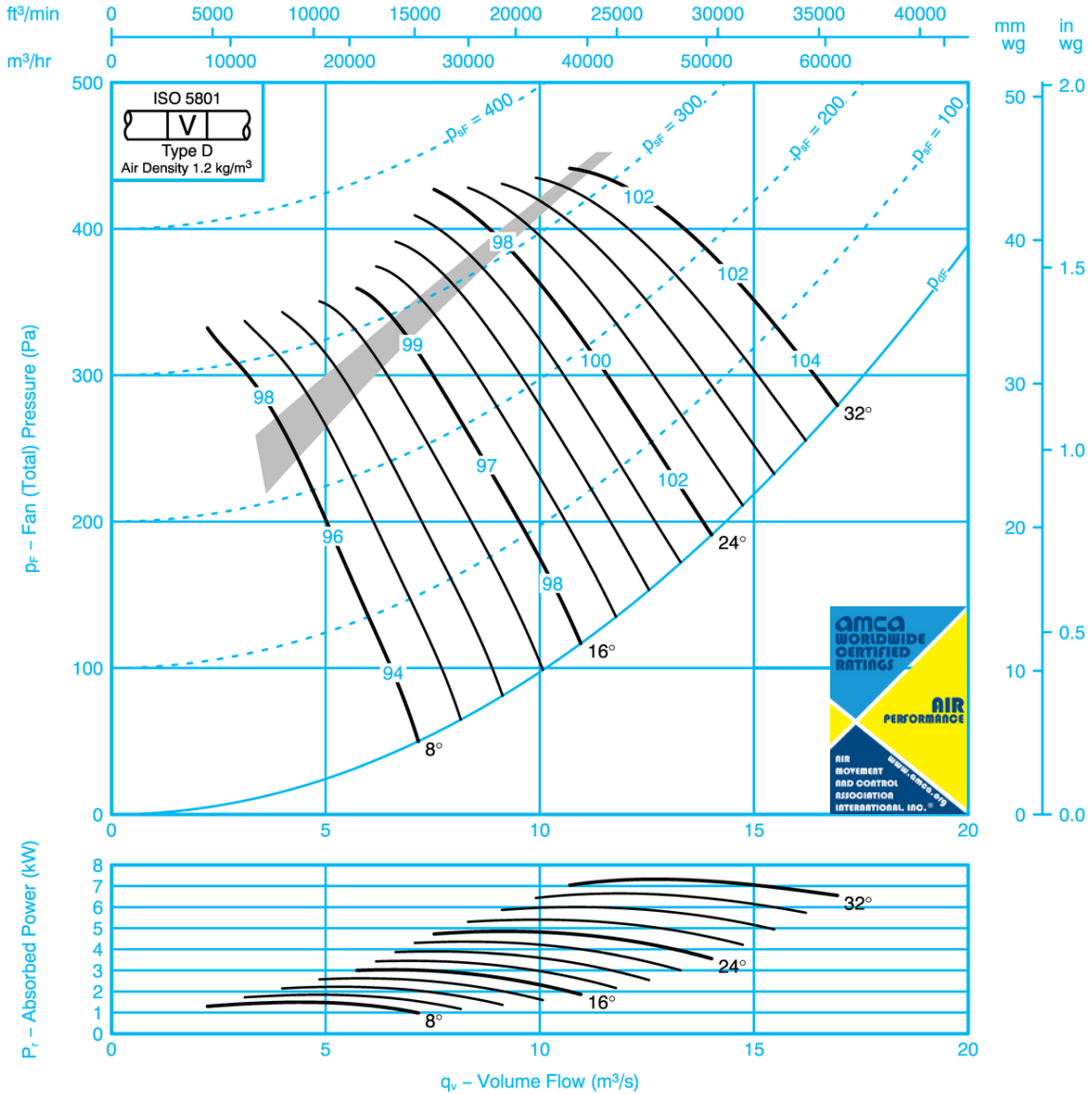

If it is intended to run this fan in reverse for other than emergency operation, please refer to Woods Air Movement.

Sound Data ISO 5136

Single figures on performance curves are overall inlet sound power levels, derived from measurements taken in Woods laboratory specifically under ducted conditions. For sound power levels in eight octave bands, apply the following corrections to the overall level. Use upper corrections when operating point is above shaded area, or lower corrections when operating point is below shaded area.

Inlet Levels								Outlet Levels												
Pitch Angle	Octave Band Centre Frequency (Hz)								Pitch Angle	Octave Band Centre Frequency (Hz)										
	63	125	250	500	1k	2k	4k	8k		63	125	250	500	1k	2k	4k	8k			
8	-14	-9	-16	-7	-4	-7	-10	-22	-28	8	-13	-9	-14	-16	-7	-4	-7	-10	-21	-26
16	-11	-5	-17	-12	-7	-10	-6	-9	-10	16	-10	-4	-17	-12	-7	-6	-9	-10	-18	-23
24-32	-7	-4	-10	-9	-8	-8	-10	-11	-15	24-32	-6	-4	-10	-8	-7	-8	-10	-11	-14	-17



Performance Data ISO 5801

Performance shown is for installations type D – Ducted inlet, Ducted outlet. Performance ratings do not include the effects of appurtenances.

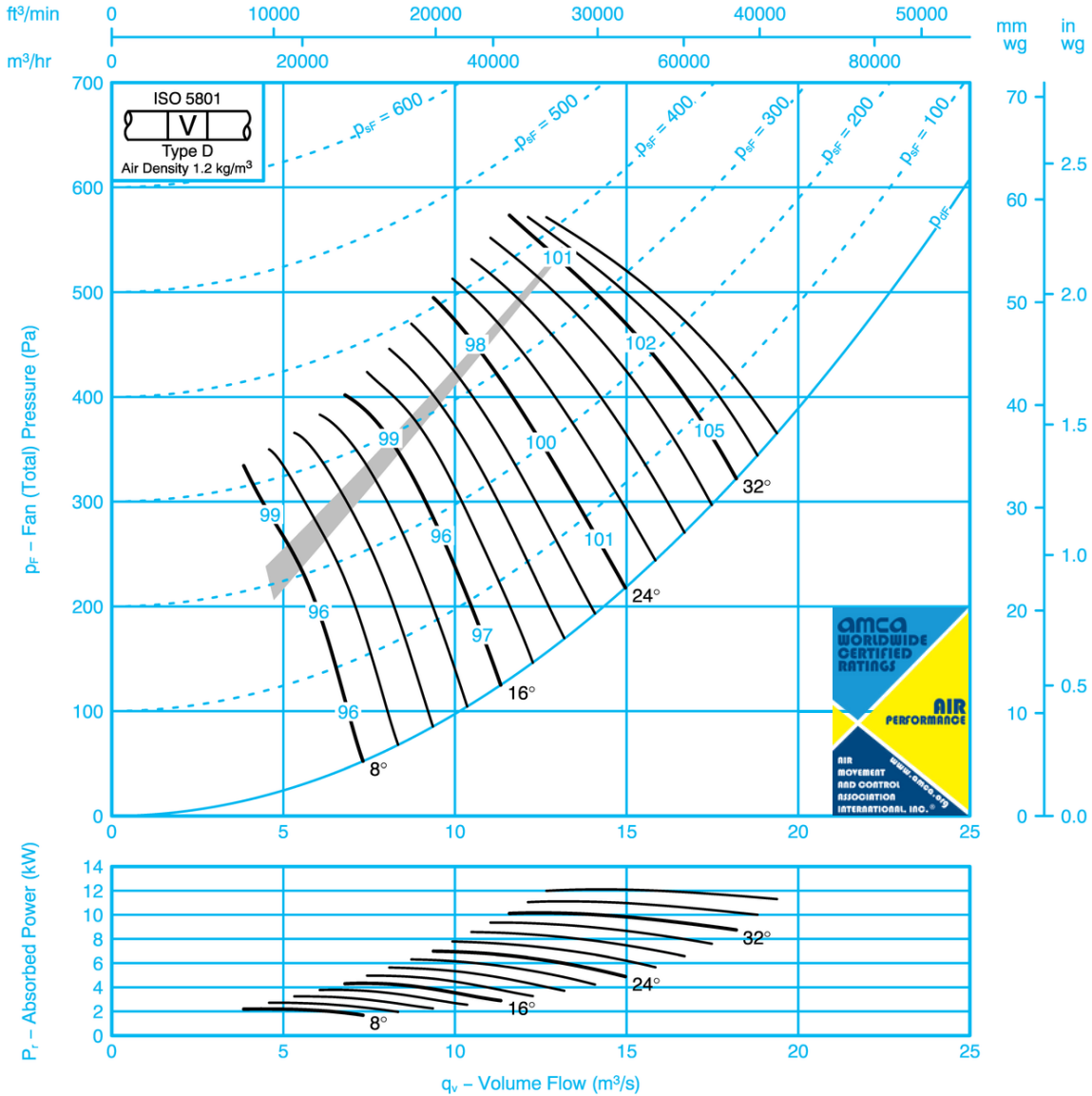

If it is intended to run this fan in reverse for other than emergency operation, please refer to Woods Air Movement.

Sound Data ISO 5136

Single figures on performance curves are overall inlet sound power levels, derived from measurements taken in Woods laboratory specifically under ducted conditions. For sound power levels in eight octave bands, apply the following corrections to the overall level. Use upper corrections when operating point is above shaded area, or lower corrections when operating point is below shaded area.

Inlet Levels								Outlet Levels									
Pitch Angle	Octave Band Centre Frequency (Hz)								Pitch Angle	Octave Band Centre Frequency (Hz)							
	63	125	250	500	1k	2k	4k	8k		63	125	250	500	1k	2k	4k	8k
8	-21	-14	-10	-5	-5	-7	-16	-26	8	-20	-12	-10	-5	-5	-7	-13	-24
	-18	-9	-9	-8	-6	-6	-13	-21		-18	-8	-9	-8	-6	-5	-6	-13
16	-15	-14	-11	-5	-5	-8	-14	-20	16	-14	-14	-11	-5	-5	-8	-13	-19
	-10	-9	-8	-8	-7	-9	-13	-17		-9	-8	-8	-8	-7	-8	-12	-16
24-36	-8	-9	-8	-8	-8	-9	-14	-17	24-36	-7	-9	-8	-8	-8	-9	-13	-15
	-6	-8	-7	-9	-10	-11	-15	-18		-6	-7	-7	-9	-10	-11	-14	-16



Performance Data ISO 5801

Performance shown is for installation type C- Ducted inlet, Ducted outlet. Performance ratings do not include the effects of appurtenances.

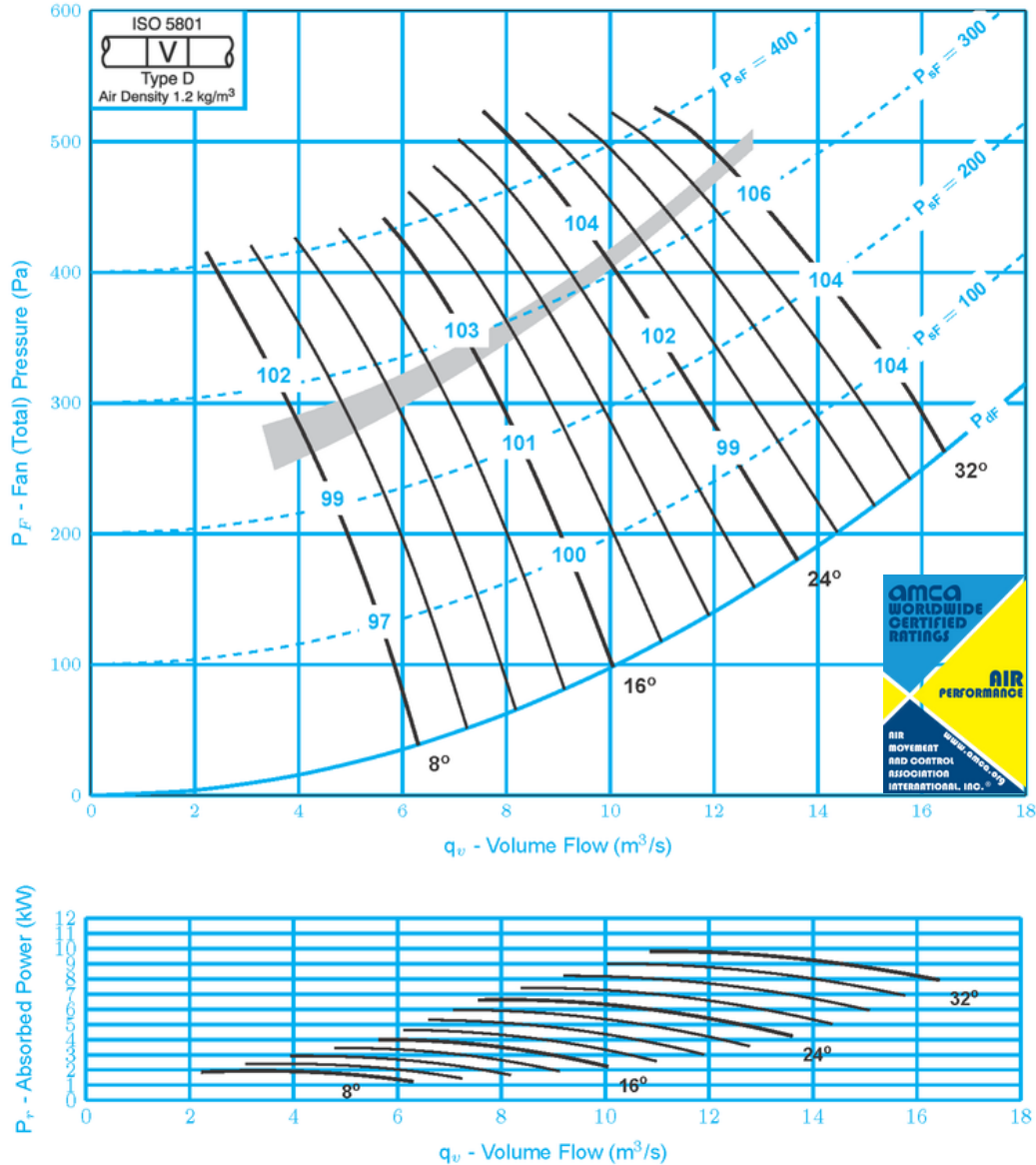

If it is intended to run this fan in reverse for other than emergency operation, please refer to Woods Air Movement.

Sound Data ISO 5136

Single figures on performance curves are overall inlet sound power levels, derived from measurements taken in Woods laboratory specifically under ducted conditions. For sound power levels in eight octave bands, apply the following corrections to the overall level. Use upper corrections when operating point is above shaded area, or lower corrections when operating point is below shaded area.

Inlet Levels									Outlet Levels								
Pitch Angle	Octave Band Center Frequency (Hz)								Pitch Angle	Octave Band Center Frequency (Hz)							
	63	125	250	500	1k	2k	4k	8k		63	125	250	500	1k	2k	4k	8k
8°	-7	-8	-7	-6	-8	-15	-21	-30	8°	-6	-6	-7	-6	-7	-15	-22	-29
	-6	-4	-9	-11	-10	-13	-18	-26		-5	-1	-9	-11	-10	-13	-18	-25
16°	-3	-7	-9	-10	-13	-17	-20	-28	16°	-1	-5	-8	-10	-13	-16	-20	-27
	-3	-6	-8	-12	-14	-16	-20	-28		-1	-4	-8	-12	-13	-16	-21	-27
24-40°	-3	-7	-9	-13	-13	-15	-19	-24	24-40°	-1	-6	-8	-13	-13	-14	-19	-23
	-4	-7	-7	-11	-12	-15	-21	-24		-1	-6	-7	-11	-12	-15	-21	-23



FAN CODE: 100JM/50/6/12/...
1000mm 1170 rev/min 12 Blades 60 Hz

Performance Data ISO 5801

Performance shown is for installation type C- Ducted inlet, Ducted outlet. Performance ratings do not include the effects of appurtenances.

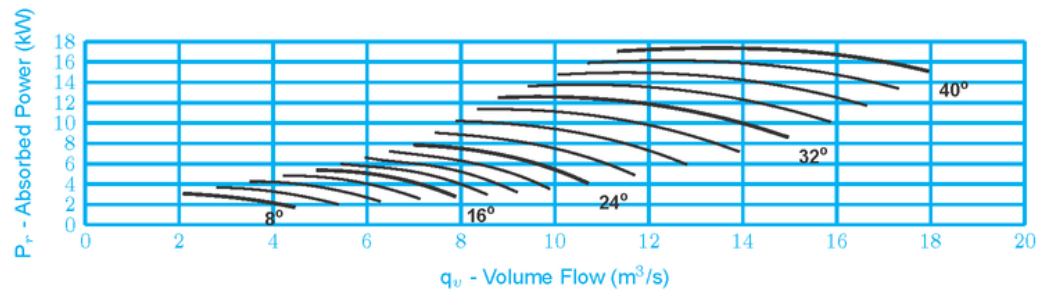
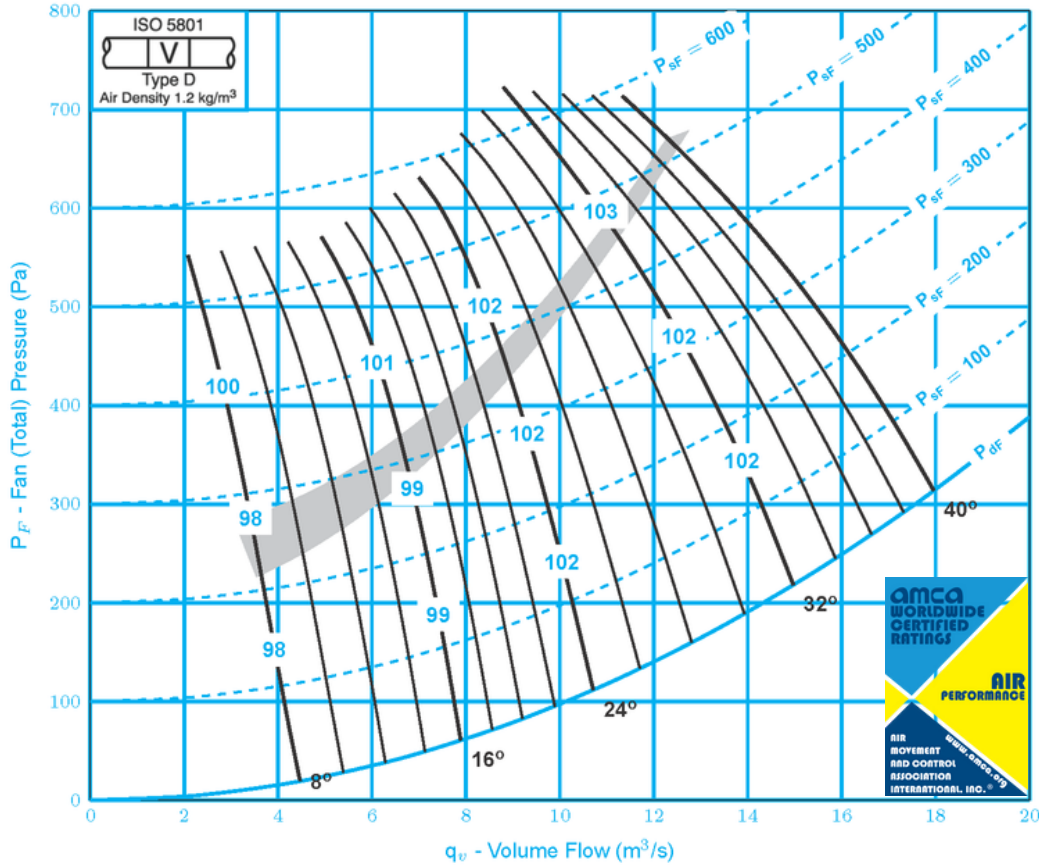

If it is intended to run this fan in reverse for other than emergency operation, please refer to Woods Air Movement.

Sound Data ISO 5136

Single figures on performance curves are overall inlet sound power levels, derived from measurements taken in Woods laboratory specifically under ducted conditions. For sound power levels in eight octave bands, apply the following corrections to the overall level. Use upper corrections when operating point is above shaded area, or lower corrections when operating point is below shaded area.

Inlet Levels									Outlet Levels								
Pitch Angle	Octave Band Center Frequency (Hz)								Pitch Angle	Octave Band Center Frequency (Hz)							
	63	125	250	500	1k	2k	4k	8k		63	125	250	500	1k	2k	4k	8k
8°	-17	-14	-5	-6	-6	-11	-17	-24	8°	-14	-12	-3	-7	-6	-9	-15	-21
	-17	-14	-5	-6	-6	-11	-16	-21		-13	-12	-3	-8	-6	-9	-13	-19
16°	-12	-13	-5	-7	-7	-11	-17	-24	16°	-10	-11	-3	-7	-6	-10	-14	-21
	-11	-13	-3	-9	-8	-12	-16	-21		-9	-11	0	-8	-8	-10	-13	-19
24-40°	-8	-9	-5	-8	-9	-13	-15	-20	24-40°	-5	-7	-4	-8	-9	-11	-13	-18
	-8	-9	-4	-9	-9	-13	-15	-20		-6	-7	-3	-9	-9	-11	-13	-18



Performance Data ISO 5801

Performance shown is for installations type D – Ducted inlet, Ducted outlet. Performance ratings do not include the effects of appurtenances.

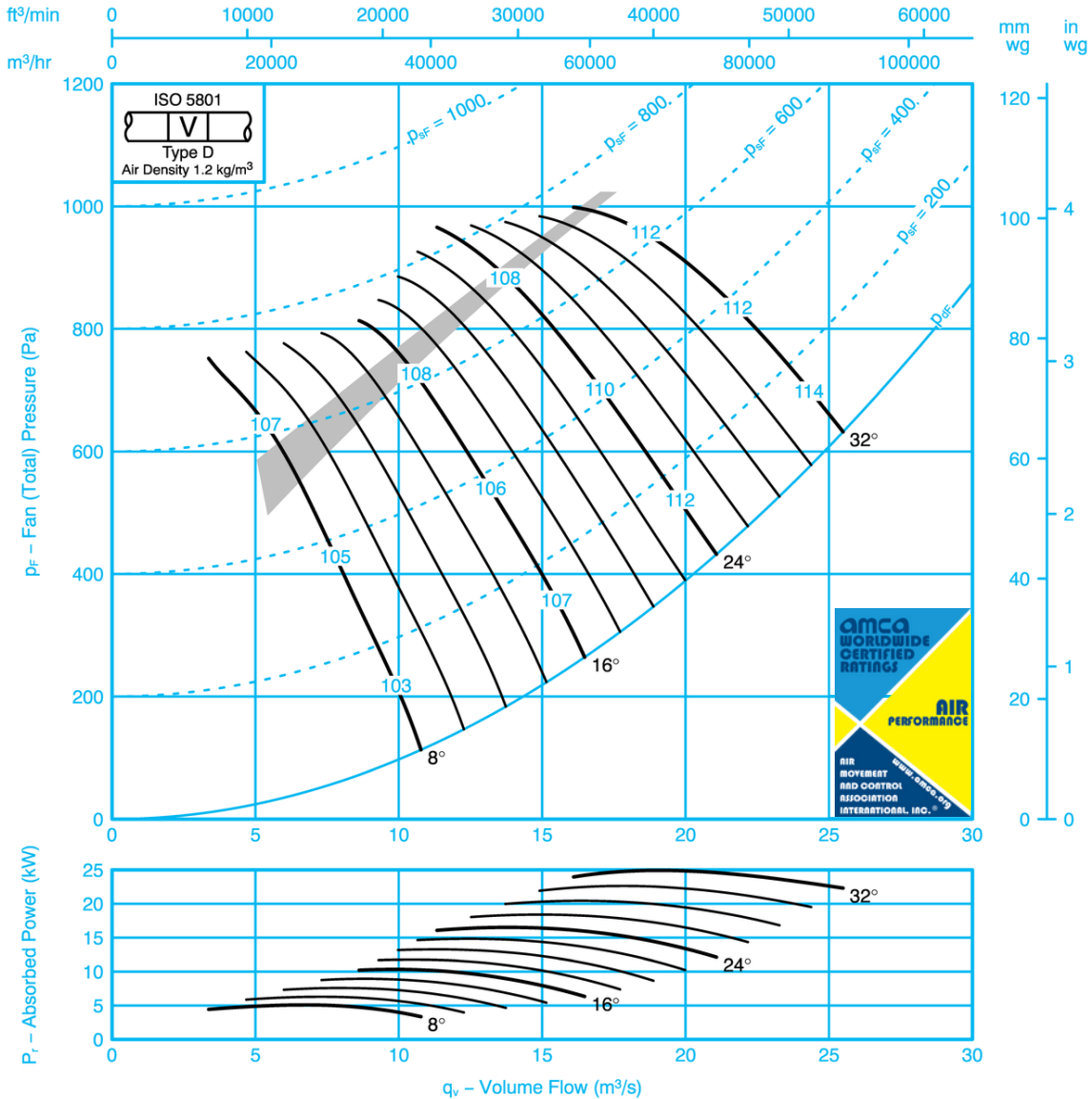

If it is intended to run this fan in reverse for other than emergency operation, please refer to Woods Air Movement.

Sound Data ISO 5136

Single figures on performance curves are overall inlet sound power levels, derived from measurements taken in Woods laboratory specifically under ducted conditions. For sound power levels in eight octave bands, apply the following corrections to the overall level. Use upper corrections when operating point is above shaded area, or lower corrections when operating point is below shaded area.

Inlet Levels								Outlet Levels									
Pitch Angle	Octave Band Centre Frequency (Hz)								Pitch Angle	Octave Band Centre Frequency (Hz)							
	63	125	250	500	1k	2k	4k	8k		63	125	250	500	1k	2k	4k	8k
8	-13	-18	-15	-5	-5	-9	-14	-23	8	-11	-16	-14	-5	-4	-8	-13	-21
	-9	-15	-16	-17	-9	-10	-13	-22		-6	-11	-13	-14	-6	-6	-10	-18
16	-9	-15	-15	-7	-4	-9	-13	-19	16	-8	-15	-15	-7	-4	-9	-12	-18
	-4	-9	-11	-11	-8	-10	-13	-18		-4	-9	-11	-11	-7	-9	-12	-16
24-32	-8	-8	-10	-8	-8	-9	-12	-16	24-32	-7	-8	-10	-8	-8	-9	-12	-15
	-5	-6	-10	-10	-11	-11	-13	-17		-5	-6	-9	-9	-11	-10	-12	-15



Performance Data ISO 5801

Performance shown is for installations type D – Ducted inlet, Ducted outlet. Performance ratings do not include the effects of appurtenances.

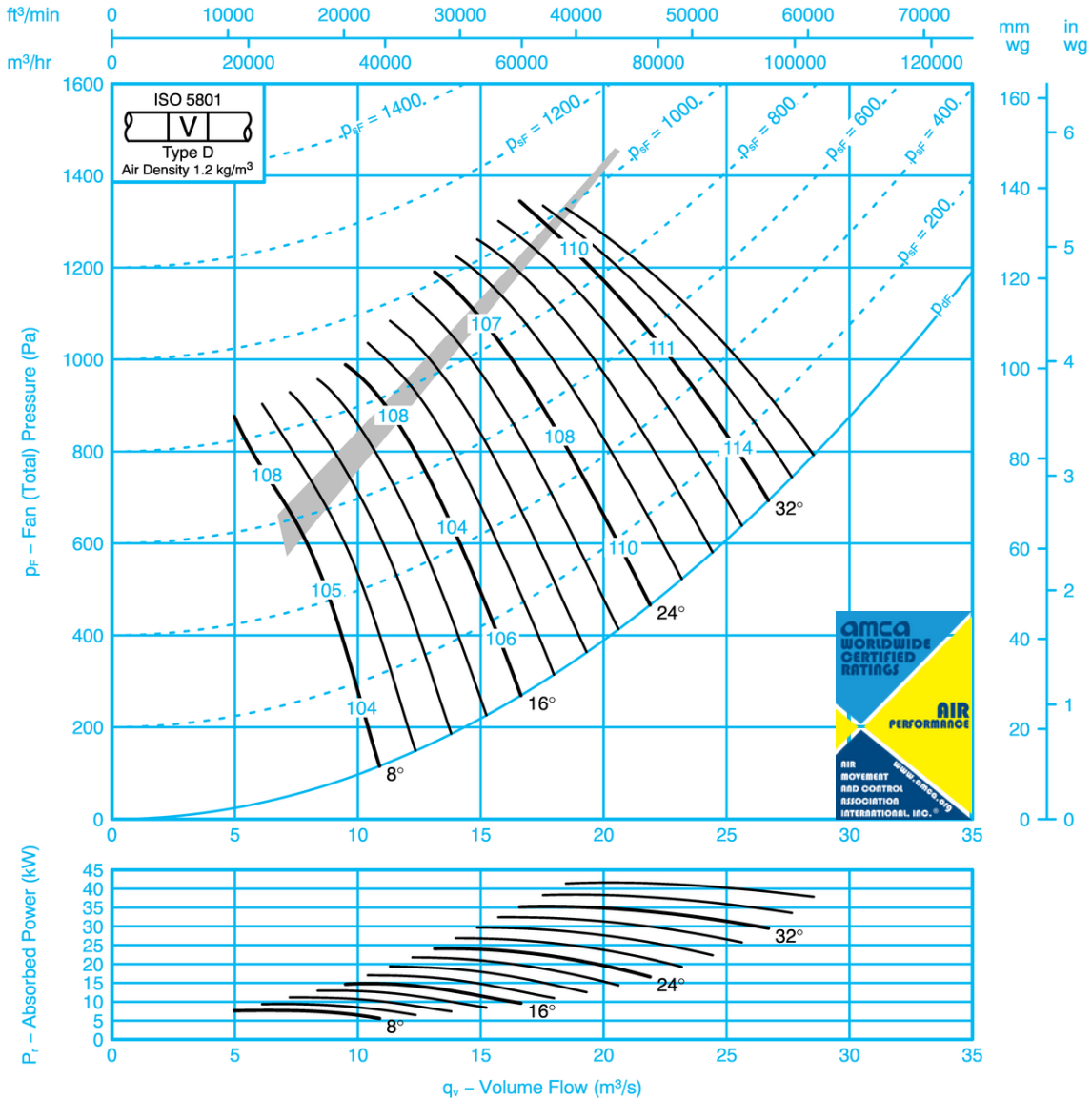

If it is intended to run this fan in reverse for other than emergency operation, please refer to Woods Air Movement.

Sound Data ISO 5136

Single figures on performance curves are overall inlet sound power levels, derived from measurements taken in Woods laboratory specifically under ducted conditions. For sound power levels in eight octave bands, apply the following corrections to the overall level. Use upper corrections when operating point is above shaded area, or lower corrections when operating point is below shaded area.

Inlet Levels								Outlet Levels									
Pitch Angle	Octave Band Centre Frequency (Hz)							Pitch Angle	Octave Band Centre Frequency (Hz)								
	63	125	250	500	1k	2k	4k		8k	63	125	250	500	1k	2k	4k	8k
8	-21	-21	-15	-10	-4	-5	-11	-18	8	-20	-20	-13	-9	-4	-5	-10	-13
	-17	-18	-11	-10	-7	-4	-8	-14		-17	-18	-9	-10	-7	-3	-8	-16
16	-15	-16	-12	-8	-4	-6	-11	-18	16	-14	-16	-12	-8	-4	-6	-10	-16
	-10	-11	-8	-8	-7	-8	-12	-16		-9	-11	-8	-8	-6	-7	-11	-15
24-36	-8	-9	-9	-8	-8	-8	-12	-16	24-36	-7	-9	-9	-8	-8	-8	-11	-14
	-7	-7	-8	-9	-10	-10	-13	-17		-6	-7	-7	-9	-10	-10	-12	-15



Performance Data ISO 5801

Performance shown is for installations type D – Ducted inlet, Ducted outlet. Performance ratings do not include the effects of appurtenances.

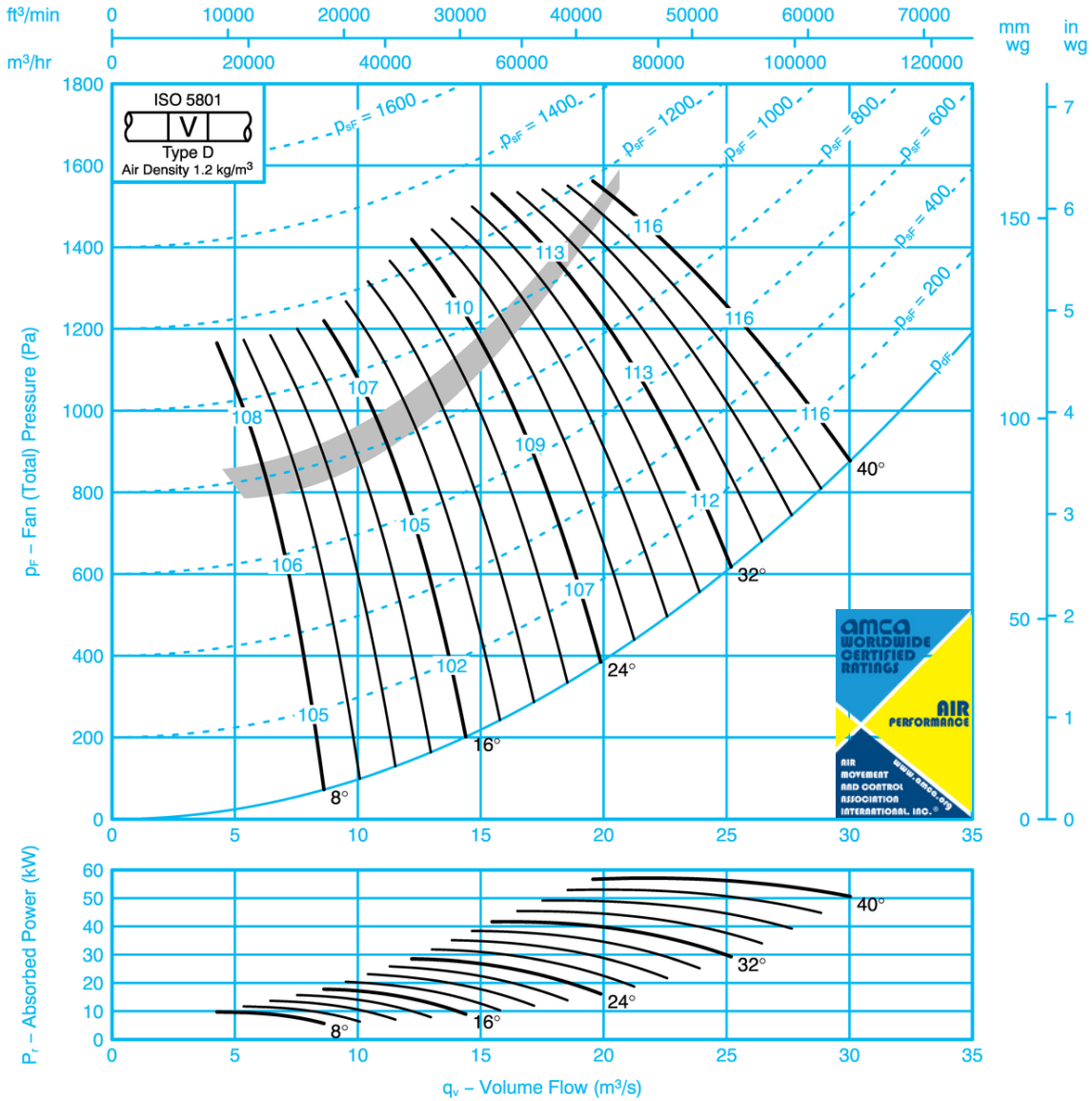

If it is intended to run this fan in reverse for other than emergency operation, please refer to Woods Air Movement.

Sound Data ISO 5136

Single figures on performance curves are overall inlet sound power levels, derived from measurements taken in Woods laboratory specifically under ducted conditions. For sound power levels in eight octave bands, apply the following corrections to the overall level. Use upper corrections when operating point is above shaded area, or lower corrections when operating point is below shaded area.

Inlet Levels									Outlet Levels								
Pitch Angle	Octave Band Centre Frequency (Hz)								Pitch Angle	Octave Band Centre Frequency (Hz)							
	63	125	250	500	1k	2k	4k	8k		63	125	250	500	1k	2k	4k	8k
8	-11	-10	-8	-5	-7	-11	-18	-24	8	-9	-7	-6	-4	-8	-11	-17	-22
	-12	-11	-6	-7	-7	-7	-12	-19		-8	-8	-4	-7	-8	-7	-11	-18
16	-10	-9	-9	-6	-7	-10	-14	-20	16	-6	-6	-8	-6	-8	-10	-13	-19
	-9	-8	-6	-7	-10	-10	-11	-18		-4	-5	-4	-7	-11	-10	-10	-17
24-40	-6	-7	-9	-6	-14	-14	-16	-18	24-40	-3	-3	-7	-5	-13	-14	-16	-17
	-7	-7	-7	-6	-14	-16	-17	-20		-4	-3	-5	-5	-13	-15	-17	-19



Performance Data ISO 5801

Performance shown is for installation type C- Ducted inlet, Ducted outlet. Performance ratings do not include the effects of appurtenances.

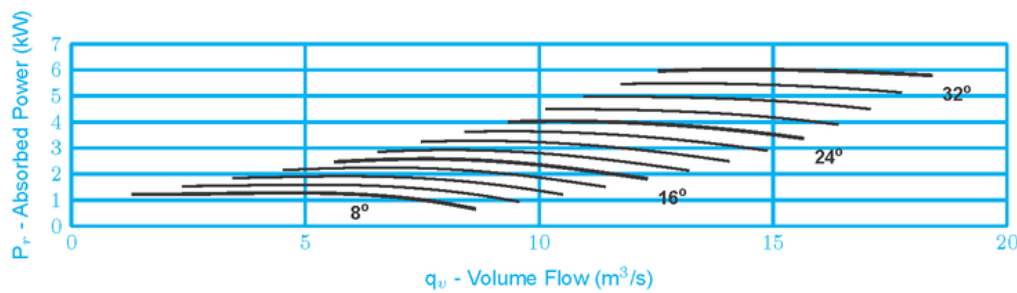
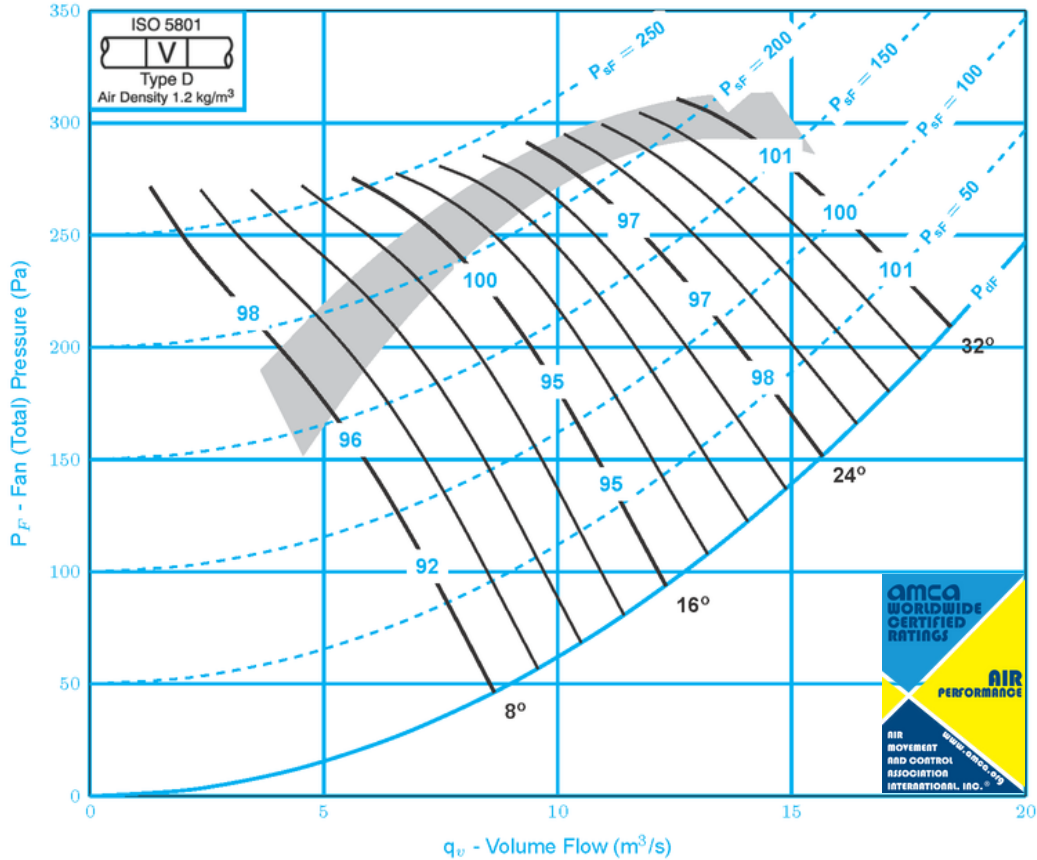

If it is intended to run this fan in reverse for other than emergency operation, please refer to Woods Air Movement.

Sound Data ISO 5136

Single figures on performance curves are overall inlet sound power levels, derived from measurements taken in Woods laboratory specifically under ducted conditions. For sound power levels in eight octave bands, apply the following corrections to the overall level. Use upper corrections when operating point is above shaded area, or lower corrections when operating point is below shaded area.

Inlet Levels									Outlet Levels								
Pitch Angle	Octave Band Center Frequency (Hz)								Pitch Angle	Octave Band Center Frequency (Hz)							
	63	125	250	500	1k	2k	4k	8k		63	125	250	500	1k	2k	4k	8k
8°	-16	-12	-6	-4	-7	-14	-19	-26	8°	-14	-12	-6	-5	-8	-13	-19	-24
	-10	-11	-10	-6	-5	-9	-15	-21		-10	-11	-10	-7	-6	-8	-15	-20
16°	-14	-13	-7	-3	-7	-14	-19	-26	16°	-13	-13	-7	-4	-8	-14	-18	-25
	-7	-9	-8	-6	-8	-11	-16	-21		-6	-9	-8	-7	-8	-11	-15	-20
24-32°	-7	-8	-7	-7	-9	-12	-16	-21	24-32°	-6	-8	-7	-8	-9	-12	-16	-19
	-5	-8	-8	-9	-9	-13	-16	-20		-4	-8	-8	-10	-10	-13	-15	-18



FAN CODE: 112JM/40/8/6/...
 1120mm 865 rev/min 6 Blades 60 Hz

Performance Data ISO 5801

Performance shown is for installations type D – Ducted inlet, Ducted outlet. Performance ratings do not include the effects of appurtenances.

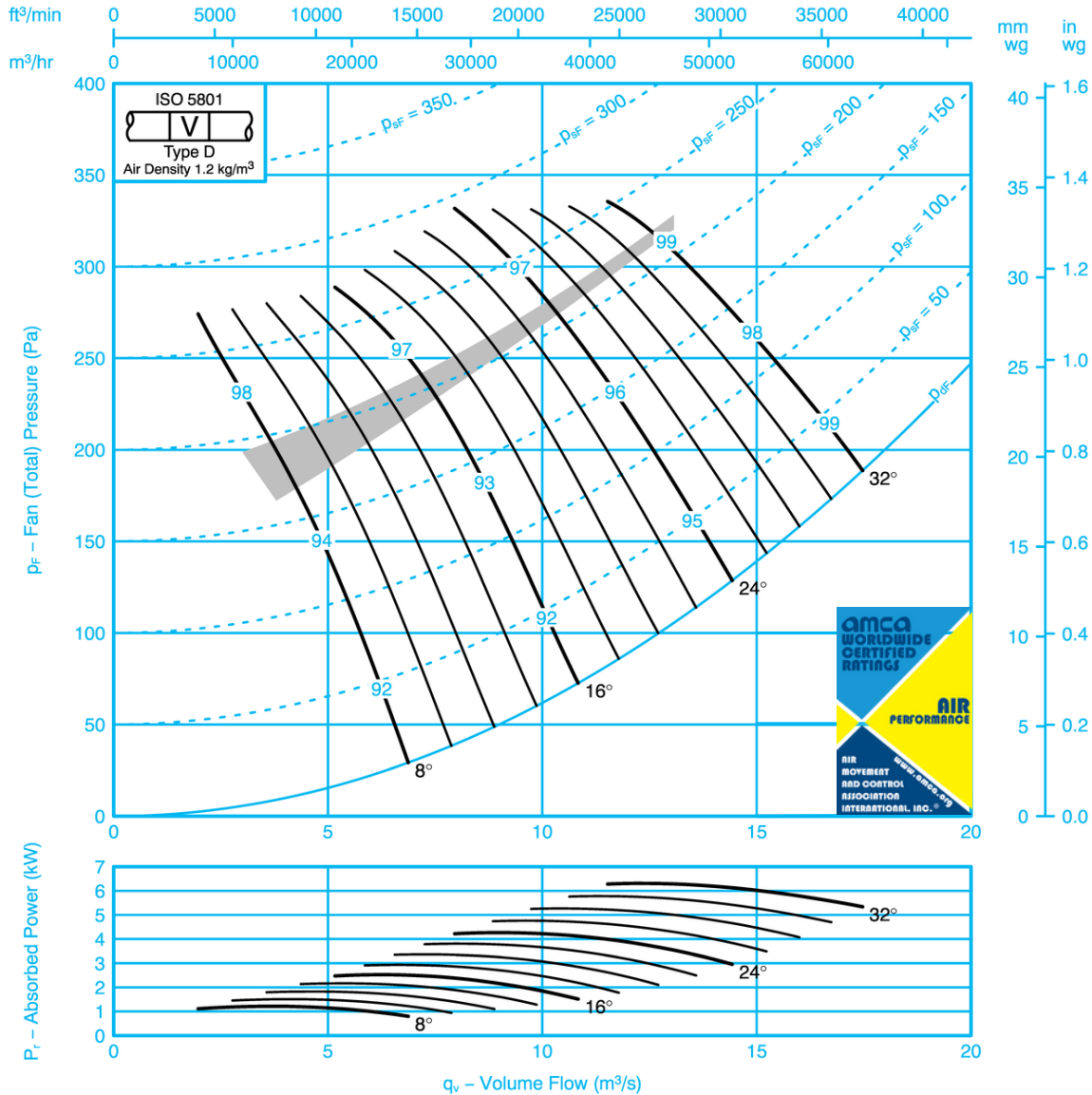

Sound Data ISO 5136

Single figures on performance curves are overall inlet sound power levels, derived from measurements taken in Woods laboratory specifically under ducted conditions. For sound power levels in eight octave bands, apply the following corrections to the overall level. Use upper corrections when operating point is above shaded area, or lower corrections when operating point is below shaded area.

Inlet Levels									Outlet Levels								
Pitch Angle	Octave Band Centre Frequency (Hz)								Pitch Angle	Octave Band Centre Frequency (Hz)							
	63	125	250	500	1k	2k	4k	8k		63	125	250	500	1k	2k	4k	8k
8	-11	-10	-5	-6	-11	-19	-24	-31	8	-8	-9	-4	-5	-11	-18	-24	-29
	-8	-11	-9	-7	-9	-14	-19	-27		-4	-9	-8	-5	-8	-13	-18	-25
16	-7	-11	-7	-7	-11	-16	-21	-28	16	-4	-9	-7	-6	-9	-14	-20	-26
	-4	-7	-8	-11	-12	-15	-19	-26		-2	-6	-8	-10	-11	-14	-19	-25
24-32	-5	-8	-8	-9	-11	-15	-18	-22	24-32	-2	-7	-8	-8	-11	-14	-17	-21
	-5	-7	-7	-10	-11	-16	-19	-23		-2	-6	-8	-10	-11	-15	-19	-21

SK12001

WAM_DC_00073GB_60HZ JM AEROFOIL
 January 2024



FAN CODE: 112JM/40/8/9/...
 1120mm 865 rev/min 9 Blades 60 Hz

Performance Data ISO 5801

Performances shown is for installations type D – Ducted inlet, Ducted outlet. Performance ratings do not include the effects of appurtenances.

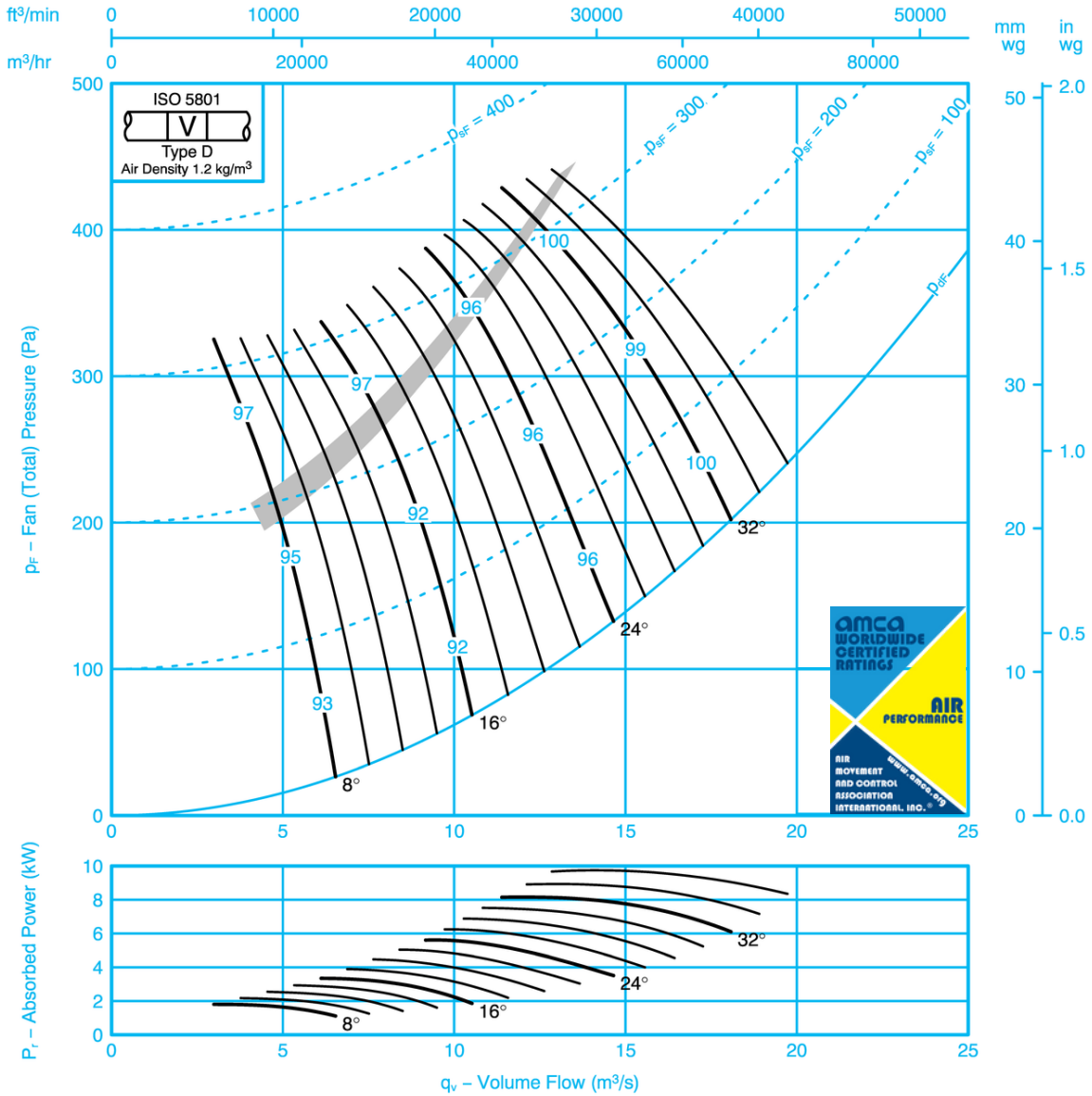

Sound Data ISO 5136

Single figures on performance curves are overall inlet sound power levels, derived from measurements taken in Woods laboratory specifically under ducted conditions. For sound power levels in eight octave bands, apply the following corrections to the overall level. Use upper corrections when operating point is above shaded area, or lower corrections when operating point is below shaded area.

Inlet Levels									Outlet Levels								
Pitch Angle	Octave Band Centre Frequency (Hz)								Pitch Angle	Octave Band Centre Frequency (Hz)							
	63	125	250	500	1k	2k	4k	8k		63	125	250	500	1k	2k	4k	8k
8	-15	-9	-5	-5	-11	-18	-25	-32	8	-12	-6	-4	-4	-11	-17	-23	-30
	-16	-9	-9	-5	-7	-12	-19	-28		-12	-6	-8	-7	-7	-12	-17	-25
16	-14	-9	-5	-5	-9	-15	-22	-29	16	-10	-7	-4	-5	-10	-16	-21	-28
	-12	-7	-8	-8	-8	-11	-17	-24		-7	-4	-6	-6	-9	-11	-15	-22
24-36	-7	-7	-6	-10	-12	-14	-17	-23	24-36	-4	-4	-4	-8	-11	-13	-16	-22
	-7	-6	-6	-10	-12	-14	-17	-24		-3	-3	-4	-9	-11	-13	-16	-23

SK12002

WAM_DC_00073GB_60HZ JM AEROFOIL
 January 2024



Performance Data ISO 5801

Performance shown is for installation type C- Ducted inlet, Ducted outlet. Performance ratings do not include the effects of appurtenances.

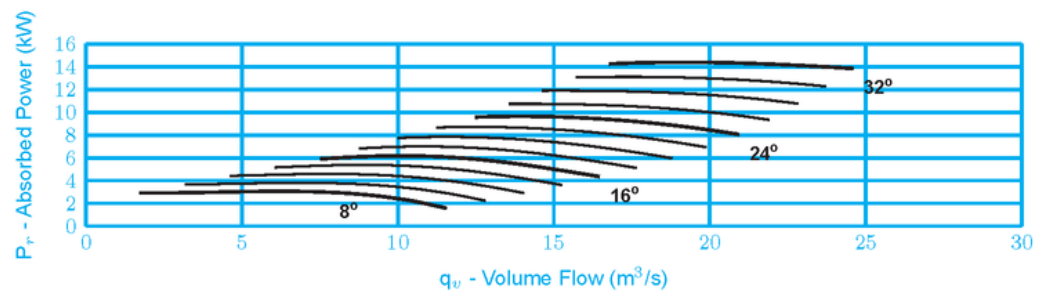
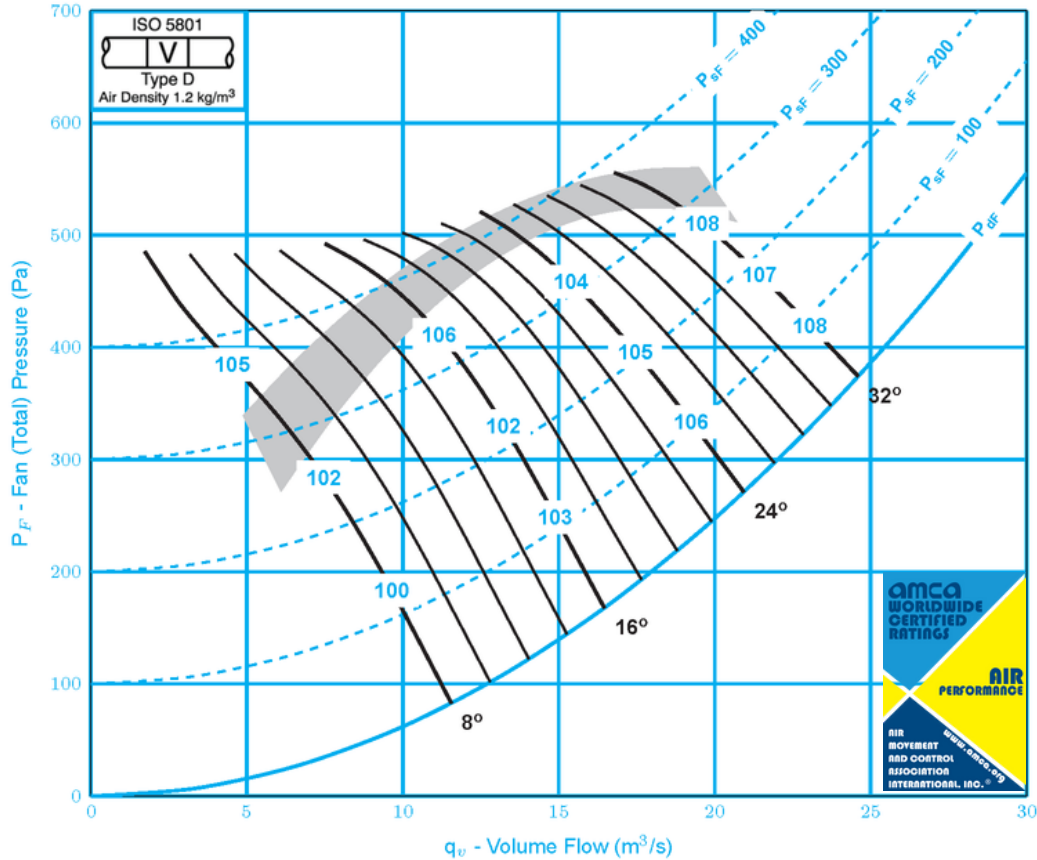

If it is intended to run this fan in reverse for other than emergency operation, please refer to Woods Air Movement.

Sound Data ISO 5136

Single figures on performance curves are overall inlet sound power levels, derived from measurements taken in Woods laboratory specifically under ducted conditions. For sound power levels in eight octave bands, apply the following corrections to the overall level. Use upper corrections when operating point is above shaded area, or lower corrections when operating point is below shaded area.

Inlet Levels									Outlet Levels								
Pitch Angle	Octave Band Center Frequency (Hz)								Pitch Angle	Octave Band Center Frequency (Hz)							
	63	125	250	500	1k	2k	4k	8k		63	125	250	500	1k	2k	4k	8k
8°	-13	-15	-8	-5	-5	-11	-17	-23	8°	-12	-14	-8	-6	-6	-11	-16	-21
	-7	-12	-10	-9	-5	-8	-13	-19		-7	-12	-10	-6	-6	-7	-13	-18
16°	-11	-15	-10	-5	-5	-11	-17	-23	16°	-9	-15	-10	-5	-5	-11	-17	-22
	-5	-10	-9	-9	-8	-10	-15	-20		-4	-10	-9	-10	-8	-10	-14	-19
24-32°	-6	-9	-8	-8	-8	-11	-16	-19	24-32°	-5	-9	-8	-8	-8	-11	-15	-18
	-4	-7	-9	-10	-10	-12	-16	-20		-3	-7	-9	-11	-10	-12	-15	-18



Performance Data ISO 5801

Performances shown is for installations type D – Ducted inlet, Ducted outlet. Performance ratings do not include the effects of appurtenances.

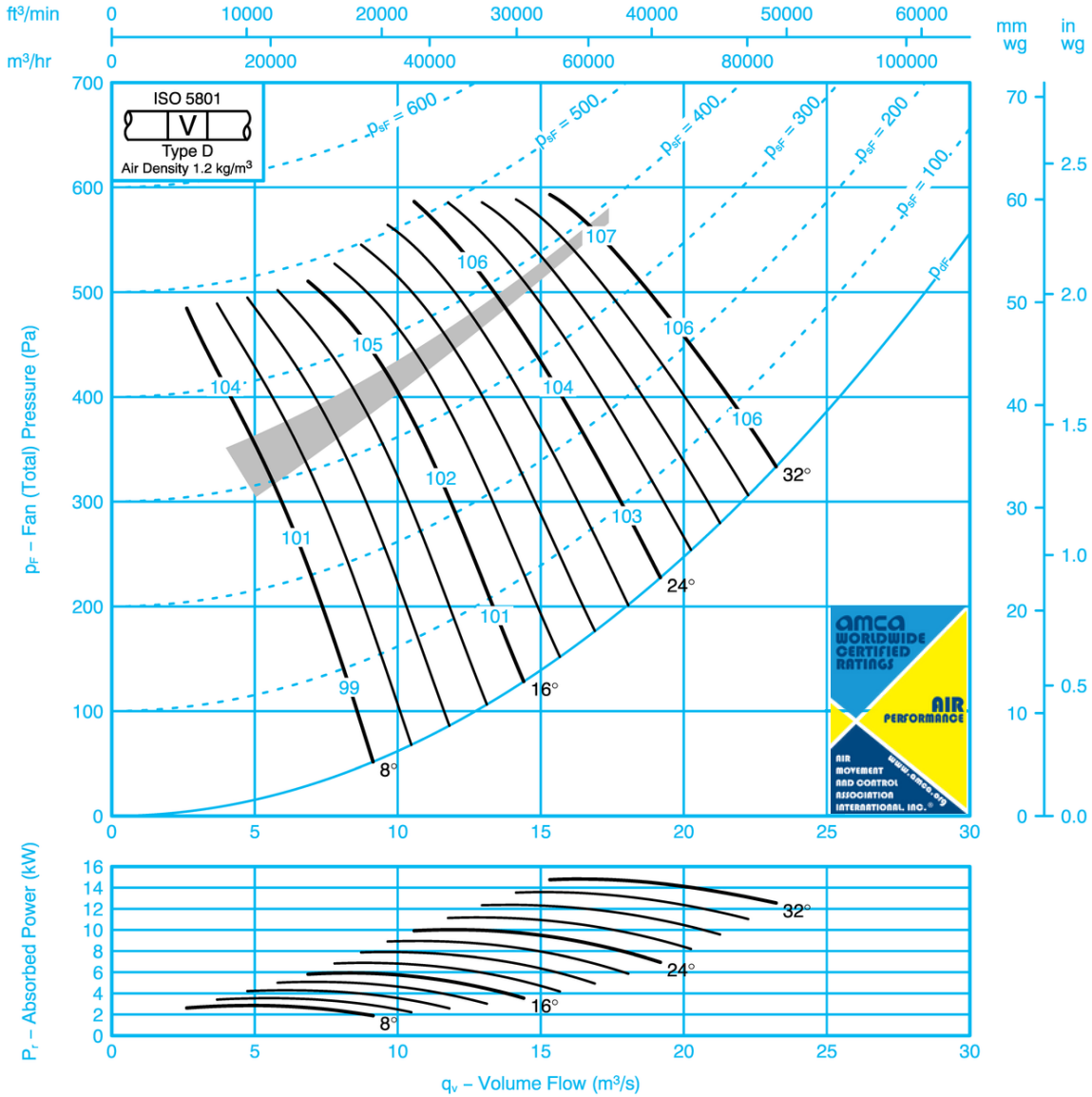

Sound Data ISO 5136

Single figures on performance curves are overall inlet sound power levels, derived from measurements taken in Woods laboratory specifically under ducted conditions. For sound power levels in eight octave bands, apply the following corrections to the overall level. Use upper corrections when operating point is above shaded area, or lower corrections when operating point is below shaded area.

Inlet Levels									Outlet Levels								
Pitch Angle	Octave Band Centre Frequency (Hz)								Pitch Angle	Octave Band Centre Frequency (Hz)							
	63	125	250	500	1k	2k	4k	8k		63	125	250	500	1k	2k	4k	8k
8	-11	-11	-6	-4	-8	-16	-21	-28	8	-10	-8	-5	-4	-8	-15	-22	-27
	-8	-8	-8	-6	-7	-11	-16	-23		-7	-5	-8	-6	-11	-16	-22	-27
16	-6	-9	-8	-7	-9	-13	-18	-25	16	-3	-7	-7	-7	-8	-13	-18	-24
	-5	-6	-7	-10	-11	-14	-17	-24		-2	-5	-6	-10	-11	-14	-18	-23
24-32	-5	-8	-7	-9	-10	-14	-17	-21	24-32	-2	-6	-6	-9	-10	-13	-17	-20
	-5	-7	-7	-10	-11	-14	-18	-22		-2	-6	-6	-10	-11	-14	-18	-21



FAN CODE: 112JM/40/6/9/...

1120mm 1150 rev/min 9 Blades 60 Hz

Performance Data ISO 5801

Performances shown is for installation type D – Ducted inlet, Ducted outlet. Performance ratings do not include the effects of appurtenances.

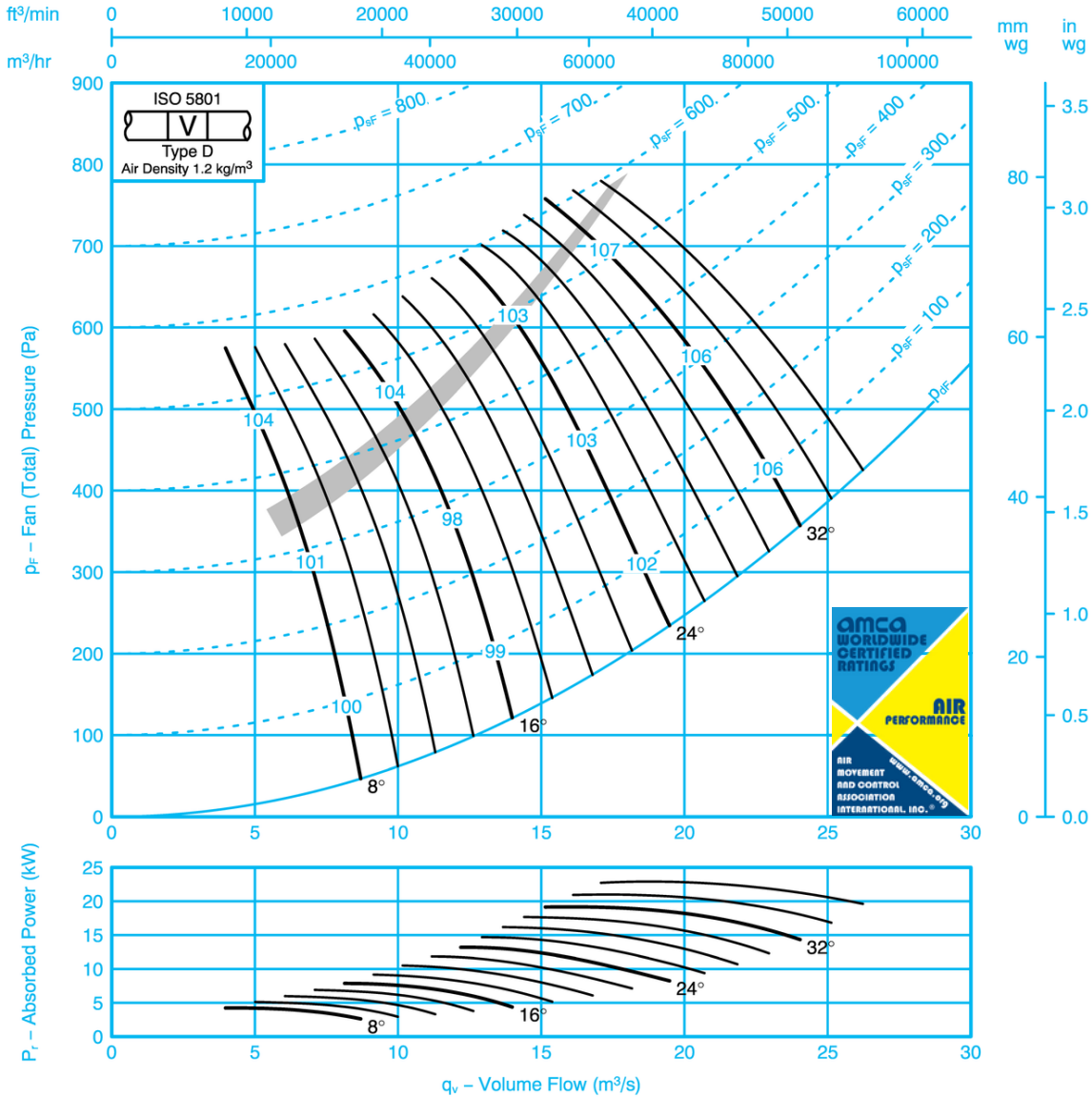

Sound Data ISO 5136

Single figures on performance curves are overall inlet sound power levels, derived from measurements taken in Woods laboratory specifically under ducted conditions. For sound power levels in eight octave bands, apply the following corrections to the overall level. Use upper corrections when operating point is above shaded area, or lower corrections when operating point is below shaded area.

Inlet Levels								Outlet Levels									
Pitch Angle	Octave Band Centre Frequency (Hz)								Pitch Angle	Octave Band Centre Frequency (Hz)							
	63	125	250	500	1k	2k	4k	8k		63	125	250	500	1k	2k	4k	8k
8	-16	-11	-5	-4	-7	-15	-21	-29	8	-13	-8	-5	-4	-8	-15	-20	-27
	-15	-10	-9	-6	-5	-10	-15	-23		-11	-6	-8	-6	-5	-10	-14	-22
16	-15	-12	-7	-4	-7	-12	-19	-26	16	-11	-10	-6	-4	-8	-13	-18	-26
	-12	-7	-8	-7	-8	-9	-14	-21		-7	-4	-6	-6	-8	-10	-12	-20
24-36	-7	-7	-7	-7	-10	-14	-15	-21	24-36	-4	-4	-6	-6	-10	-13	-14	-20
	-7	-6	-7	-8	-11	-14	-15	-22		-4	-3	-5	-7	-10	-13	-14	-21

SK12006

WAM_DC_00073GB_60HZ JM AEROFOIL
January 2024



Performance Data ISO 5801

Performance shown is for installations type D – Ducted inlet, Ducted outlet. Performance ratings do not include the effects of appurtenances.

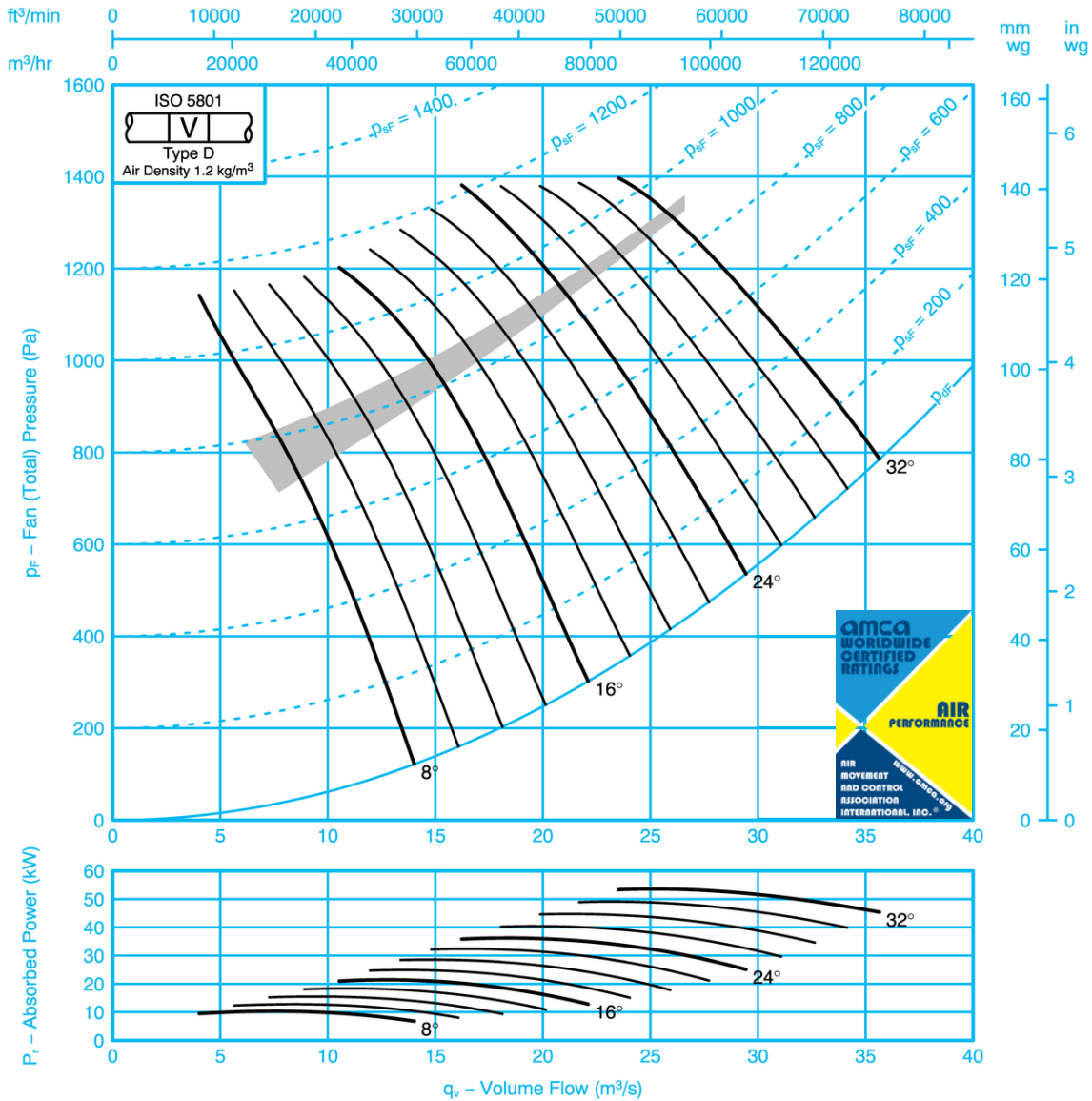

If it is intended to run this fan in reverse for other than emergency operation, please refer to Woods Air Movement.

Sound Data ISO 5136

Single figures on performance curves are overall inlet sound power levels, derived from measurements taken in Woods laboratory specifically under ducted conditions. For sound power levels in eight octave bands, apply the following corrections to the overall level. Use upper corrections when operating point is above shaded area, or lower corrections when operating point is below shaded area.

Inlet Levels								Outlet Levels									
Pitch Angle	Octave Band Centre Frequency (Hz)								Pitch Angle	Octave Band Centre Frequency (Hz)							
	63	125	250	500	1k	2k	4k	8k		63	125	250	500	1k	2k	4k	8k
8	-12	-10	-10	-4	-6	-11	-19	-24	8	-11	-8	-9	-4	-5	-11	-19	-23
	-9	-7	-11	-8	-6	-8	-13	-18		-8	-5	-10	-8	-6	-8	-14	-17
16	-7	-7	-11	-7	-7	-11	-15	-20	16	-5	-5	-11	-7	-7	-10	-16	-19
	-5	-5	-9	-9	-9	-12	-16	-19		-4	-4	-9	-9	-11	-12	-16	-18
24-32	-6	-6	-10	-8	-9	-12	-15	-19	24-32	-4	-4	-9	-8	-10	-11	-15	-18
	-6	-6	-8	-8	-11	-12	-17	-20		-4	-4	-8	-8	-11	-12	-16	-19



Performance Data ISO 5801

Performances shown is for installations type D – Ducted inlet, Ducted outlet. Performance ratings do not include the effects of appurtenances.

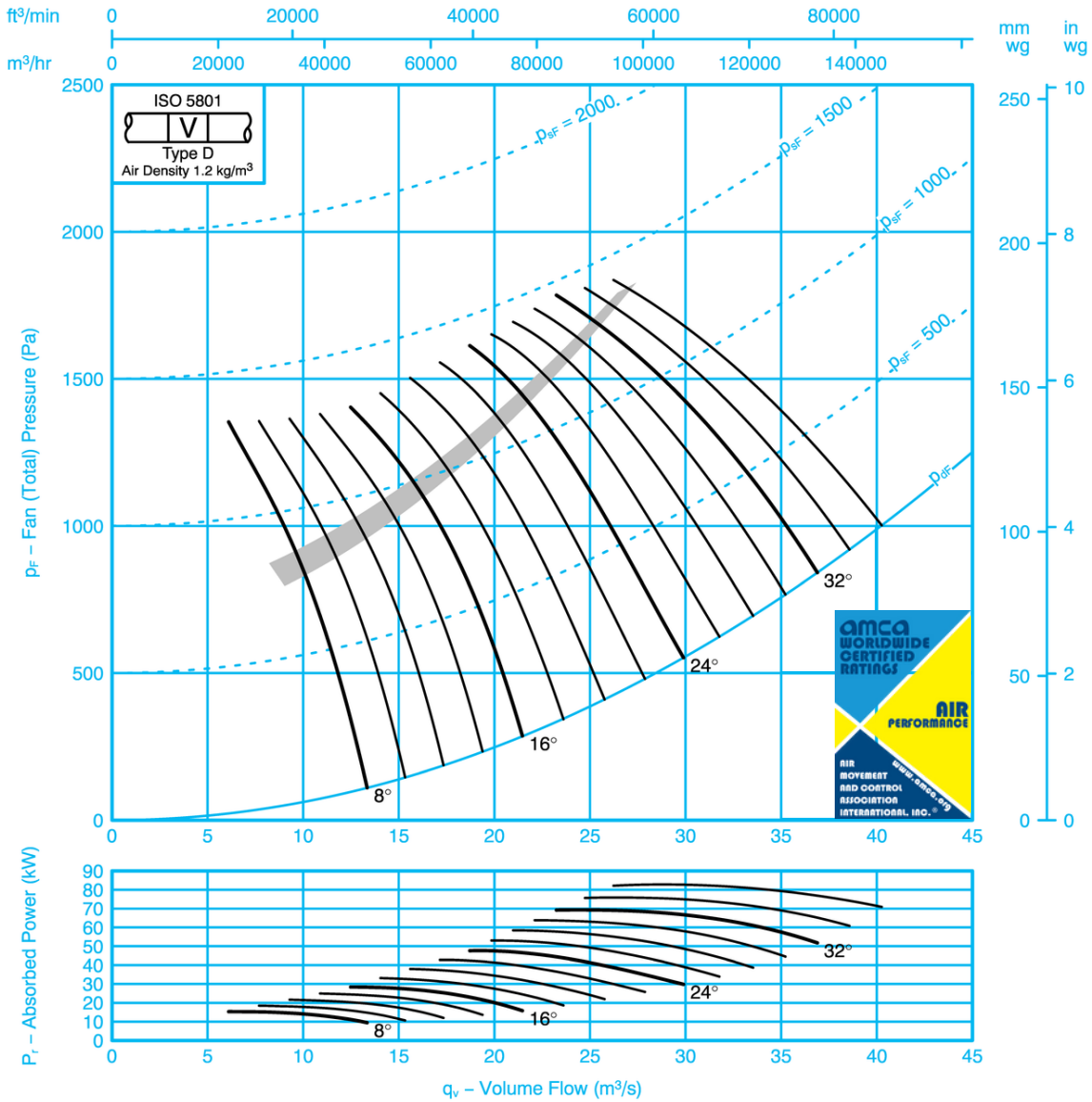

If it is intended to run this fan in reverse for other than emergency operation, please refer to Woods Air Movement.

Sound Data ISO 5136

Single figures on performance curves are overall inlet sound power levels, derived from measurements taken in Woods laboratory specifically under ducted conditions. For sound power levels in eight octave bands, apply the following corrections to the overall level. Use upper corrections when operating point is above shaded area, or lower corrections when operating point is below shaded area.

Inlet Levels									Outlet Levels								
Pitch Angle	Octave Band Centre Frequency (Hz)								Pitch Angle	Octave Band Centre Frequency (Hz)							
	63	125	250	500	1k	2k	4k	8k		63	125	250	500	1k	2k	4k	8k
8	-17	-14	-9	-4	-5	-10	-17	-24	8	-15	-12	-7	-4	-5	-10	-16	-22
	-16	-16	-8	-8	-5	-6	-12	-18		-13	-13	-6	-8	-5	-7	-11	-16
16	-16	-14	-9	-5	-5	-9	-15	-22	16	-12	-11	-8	-6	-6	-10	-14	-21
	-13	-12	-6	-7	-7	-8	-10	-16		-9	-9	-4	-7	-8	-9	-9	-15
24-36	-8	-8	-7	-6	-10	-12	-14	-17	24-36	-5	-4	-6	-5	-10	-11	-14	-16
	-8	-7	-6	-6	-11	-13	-15	-17		-5	-4	-4	-5	-10	-12	-14	-16



FAN CODE: 112JM/50/4/12/...
1120mm 1765 rev/min 12 Blades 60 Hz

Performance Data ISO 5801

Performances shown is for installations type D – Ducted inlet, Ducted outlet. Performance ratings do not include the effects of appurtenances.

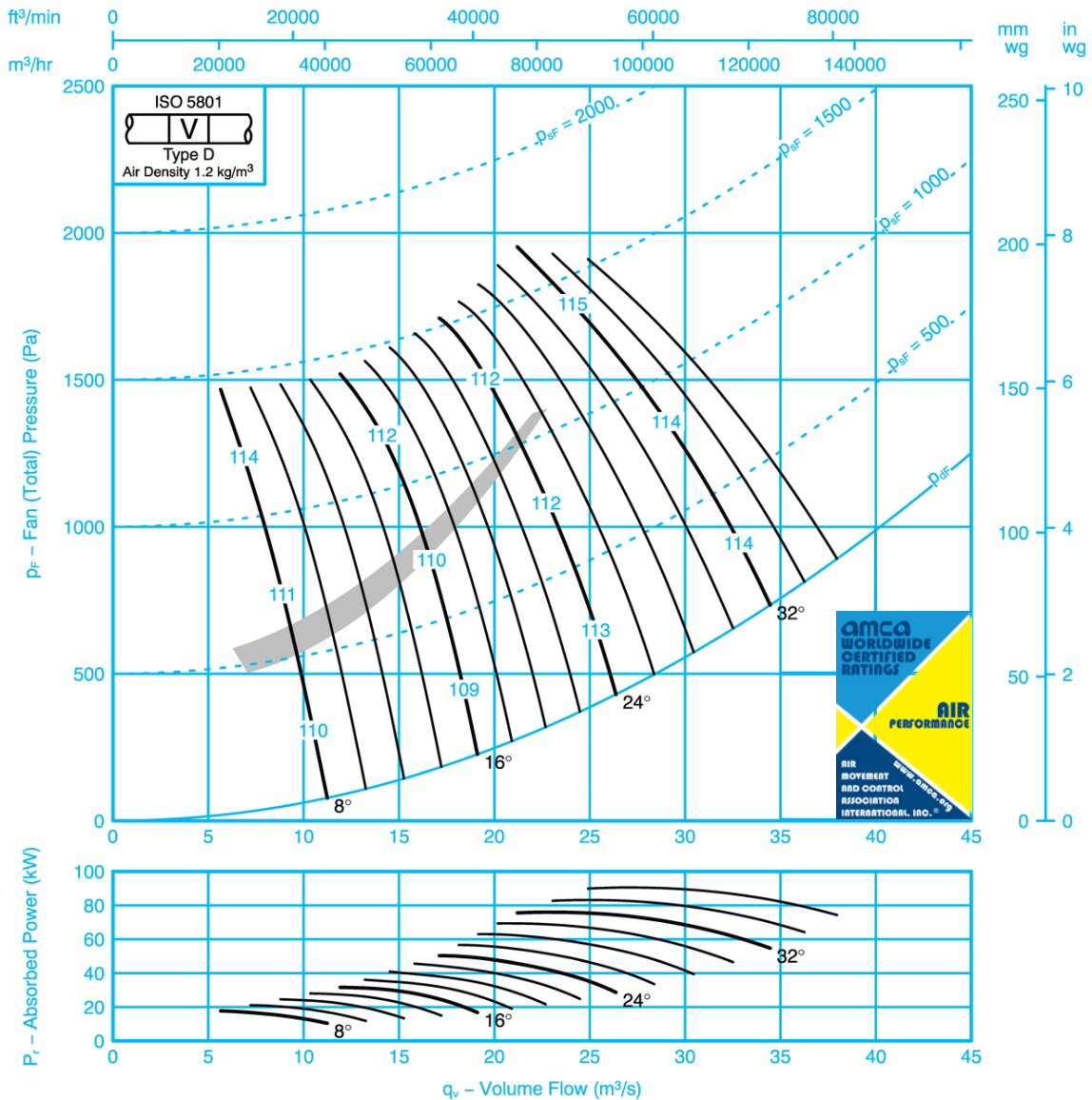

If it is intended to run this fan in reverse for other than emergency operation, please refer to Woods Air Movement.

Sound Data ISO 5136

Single figures on performance curves are overall inlet sound power levels, derived from measurements taken in Woods laboratory specifically under ducted conditions. For sound power levels in eight octave bands, apply the following corrections to the overall level. Use upper corrections when operating point is above shaded area, or lower corrections when operating point is below shaded area.

Inlet Levels									Outlet Levels								
Pitch Angle	Octave Band Centre Frequency (Hz)								Pitch Angle	Octave Band Centre Frequency (Hz)							
	63	125	250	500	1k	2k	4k	8k		63	125	250	500	1k	2k	4k	8k
8	-17	-18	-6	-8	-5	-9	-16	-21	8	-14	-16	-4	-8	-4	-6	-13	-18
	-17	-17	-5	-8	-5	-9	-14	-19		-14	-15	-3	-8	-5	-7	-12	-17
16	-12	-15	-3	-7	-6	-9	-15	-21	16	-10	-13	-3	-7	-6	-7	-12	-18
	-11	-14	-3	-9	-8	-10	-14	-19		-9	-12	-1	-9	-8	-9	-11	-16
24-36	-8	-9	-5	-9	-9	-11	-15	-18	24-36	-6	-7	-4	-8	-9	-9	-12	-16
	-8	-10	-4	-9	-9	-11	-15	-18		-6	-7	-3	-9	-9	-9	-12	-16

SK12011

WAM_DC_00073GB_60HZ JM AEROFOIL
January 2024



FAN CODE: 125JM/40/10/6/...
 1250mm 690 rev/min 6 Blades 60 Hz

Performance Data ISO 5801

Performance shown is for installations type D – Ducted inlet, Ducted outlet. Performance ratings do not include the effects of appurtenances.

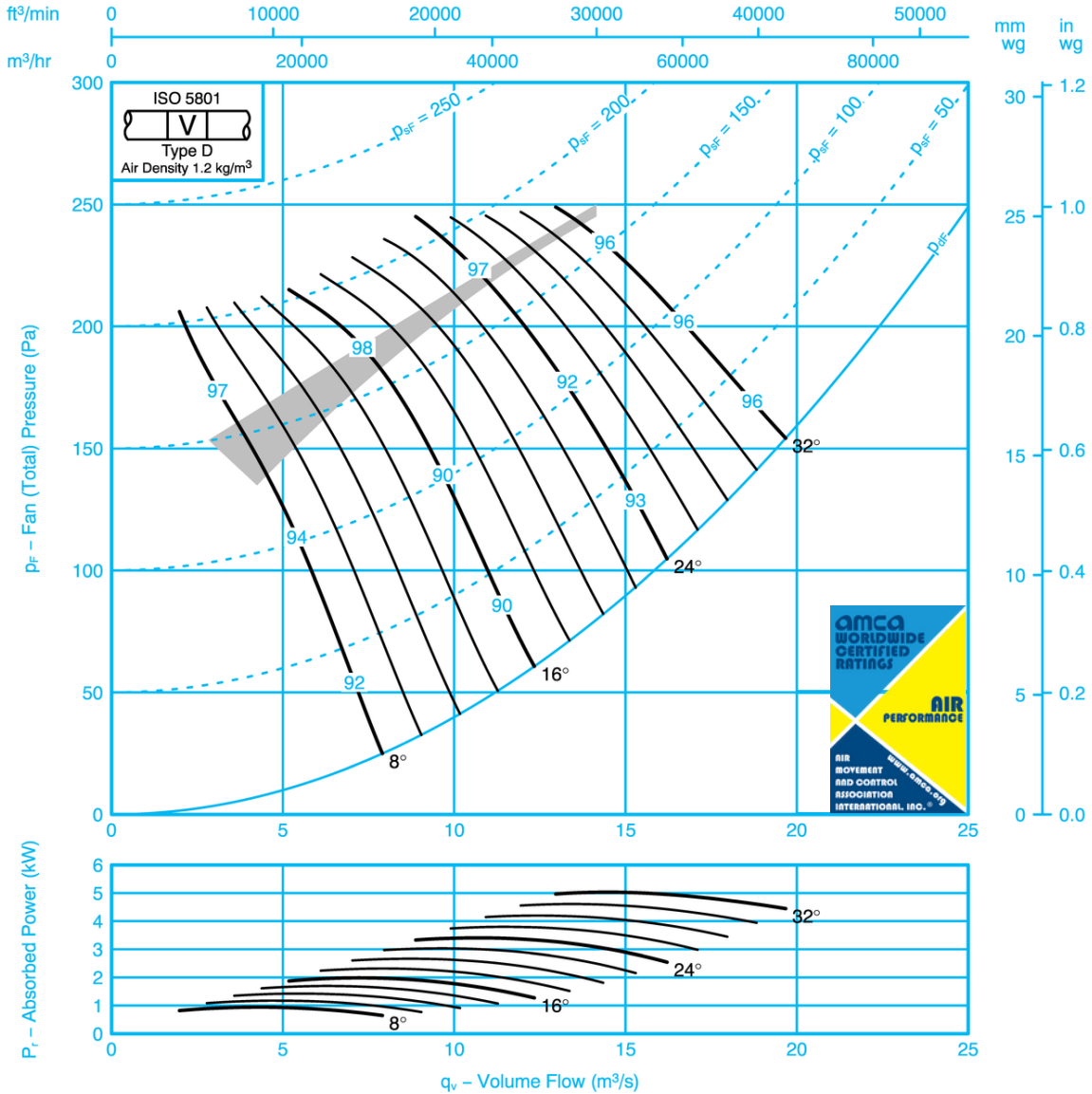

Sound Data ISO 5136

Single figures on performance curves are overall inlet sound power levels, derived from measurements taken in Woods laboratory specifically under ducted conditions. For sound power levels in eight octave bands, apply the following corrections to the overall level. Use upper corrections when operating point is above shaded area, or lower corrections when operating point is below shaded area.

Inlet Levels									Outlet Levels								
Pitch Angle	Octave Band Centre Frequency (Hz)								Pitch Angle	Octave Band Centre Frequency (Hz)							
	63	125	250	500	1k	2k	4k	8k		63	125	250	500	1k	2k	4k	8k
8	-12	-6	-4	-7	-15	-21	-26	-31	8	-9	-5	-4	-7	-15	-21	-26	-30
	-15	-10	-5	-4	-9	-15	-19	-29		-12	-10	-5	-4	-9	-15	-19	-28
16	-12	-9	-5	-4	-10	-16	-22	-27	16	-9	-8	-5	-4	-9	-15	-22	-26
	-7	-5	-8	-8	-10	-13	-16	-24		-5	-4	-8	-8	-10	-13	-17	-23
24-32	-10	-7	-7	-5	-12	-16	-19	-21	24-32	-7	-5	-7	-5	-12	-15	-18	-20
	-7	-4	-8	-8	-12	-15	-17	-20		-4	-3	-8	-8	-12	-14	-17	-19

SK12030

WAM_DC_00073GB_60HZ JM AEROFOIL
 January 2024



FAN CODE: 125JM/40/10/9/...
 1250mm 690 rev/min 9 Blades 60 Hz

Performance Data ISO 5801

Performances shown is for installations type D – Ducted inlet, Ducted outlet. Performance ratings do not include the effects of appurtenances.

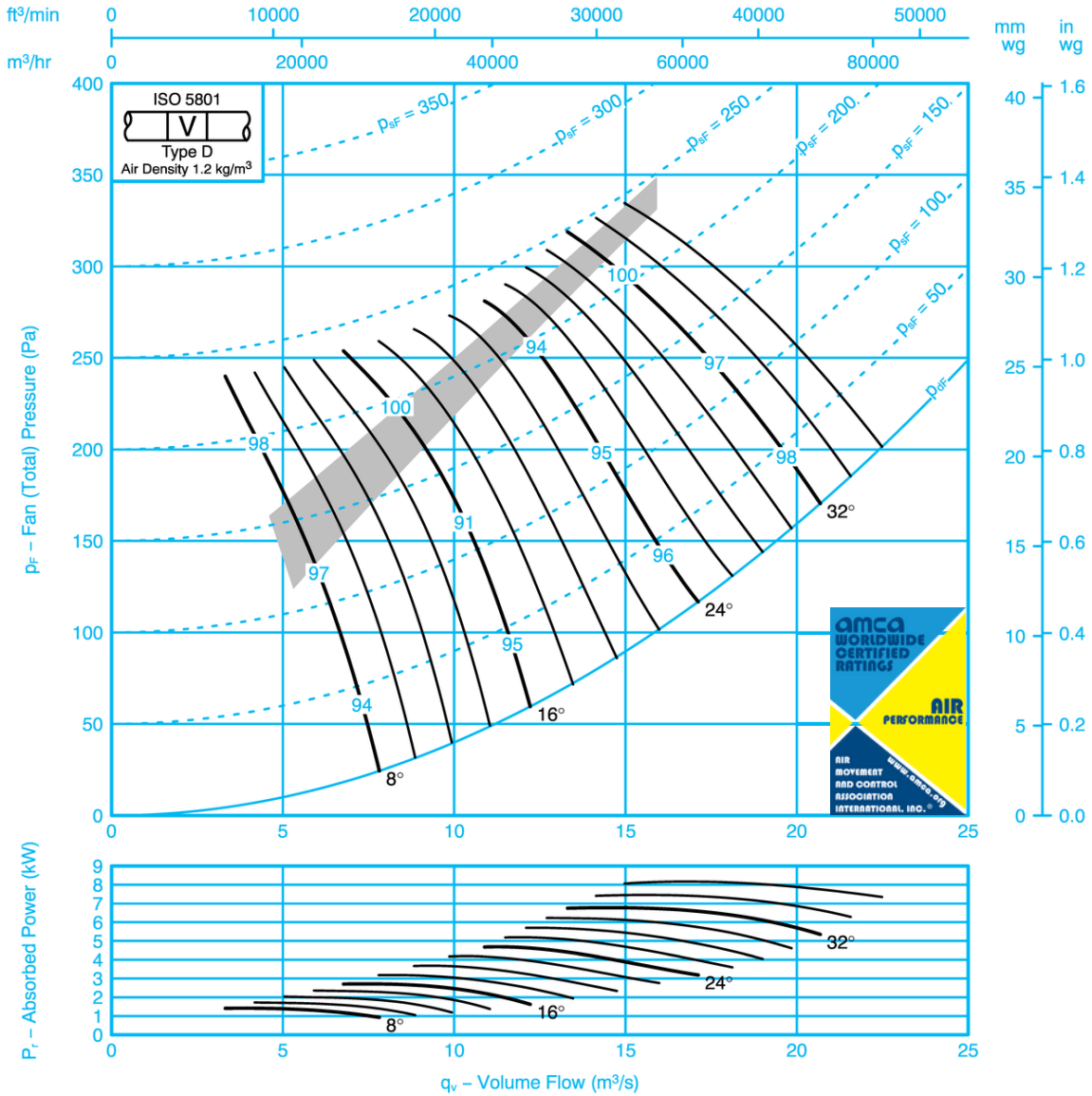

Sound Data ISO 5136

Single figures on performance curves are overall inlet sound power levels, derived from measurements taken in Woods laboratory specifically under ducted conditions. For sound power levels in eight octave bands, apply the following corrections to the overall level. Use upper corrections when operating point is above shaded area, or lower corrections when operating point is below shaded area.

Inlet Levels									Outlet Levels								
Pitch Angle	Octave Band Centre Frequency (Hz)								Pitch Angle	Octave Band Centre Frequency (Hz)							
	63	125	250	500	1k	2k	4k	8k		63	125	250	500	1k	2k	4k	8k
8	-17	-7	-4	-4	-13	-21	-28	-34	8	-15	-6	-4	-4	-13	-21	-27	-33
	-22	-10	-8	-3	-9	-15	-19	-30		-19	-7	-7	-2	-9	-15	-18	-28
16	-19	-8	-4	-4	-12	-19	-27	-32	16	-14	-6	-3	-5	-13	-20	-27	-32
	-15	-7	-7	-5	-8	-12	-17	-25		-11	-3	-6	-4	-9	-13	-16	-24
24-36	-9	-6	-6	-7	-12	-14	-20	-25	24-36	-6	-3	-5	-5	-11	-13	-19	-24
	-8	-5	-7	-7	-11	-13	-16	-23		-5	-1	-6	-6	-11	-12	-16	-22

SK12031

WAM_DC_00073GB_60HZ JM AEROFOIL
 January 2024



FAN CODE: 125JM/40/8/6/...
1250mm 865 rev/min 6 Blades 60 Hz

Performance Data ISO 5801

Performances shown is for installations type D – Ducted inlet, Ducted outlet. Performance ratings do not include the effects of appurtenances.

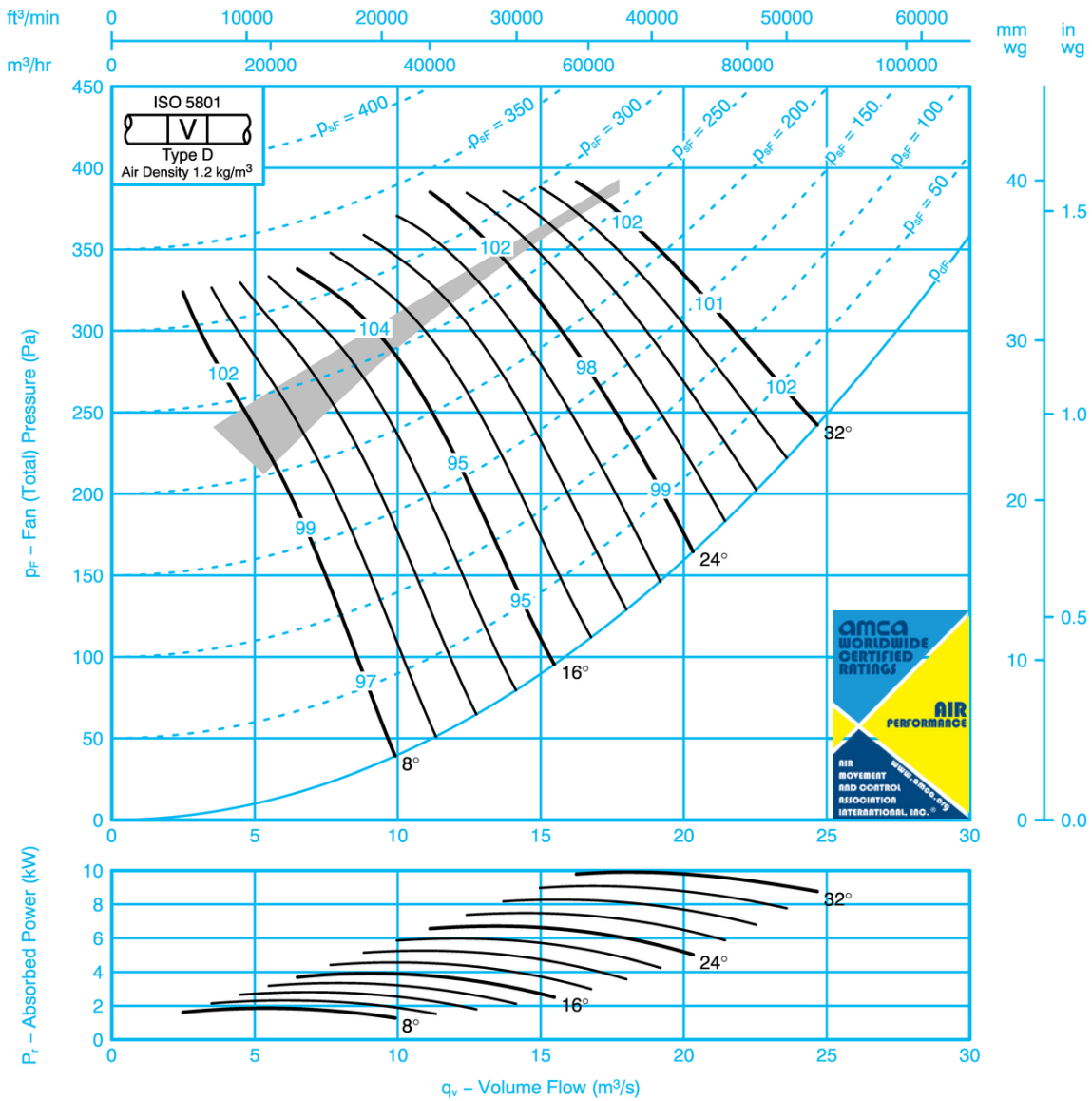

Sound Data ISO 5136

Single figures on performance curves are overall inlet sound power levels, derived from measurements taken in Woods laboratory specifically under ducted conditions. For sound power levels in eight octave bands, apply the following corrections to the overall level. Use upper corrections when operating point is above shaded area, or lower corrections when operating point is below shaded area.

Inlet Levels		Outlet Levels															
Pitch Angle	Octave Band Centre Frequency (Hz)								Pitch Angle	Octave Band Centre Frequency (Hz)							
	63	125	250	500	1k	2k	4k	8k		63	125	250	500	1k	2k	4k	8k
8	-15	-7	-4	-6	-13	-20	-25	-30	8	-12	-6	-4	-6	-12	-20	-25	-28
	-13	-12	-7	-4	-7	-14	-18	-26		-11	-11	-7	-4	-7	-14	-18	-25
16	-11	-11	-7	-4	-8	-14	-20	-26	16	-8	-9	-7	-4	-8	-13	-20	-24
	-6	-6	-8	-9	-10	-13	-15	-23		-4	-5	-8	-9	-9	-13	-16	-22
24-32	-8	-8	-7	-5	-11	-15	-18	-21	24-32	-6	-7	-8	-5	-11	-14	-18	-20
	-6	-6	-8	-9	-11	-15	-17	-20		-3	-5	-8	-9	-11	-14	-17	-19

SK12015

WAM_DC_00073GB_60HZ JM AEROFOIL
January 2024



FAN CODE: 125JM/40/8/9/...
 1250mm 865 rev/min 9 Blades 60 Hz

Performance Data ISO 5801

Performance shown is for installations type D – Ducted inlet, Ducted outlet. Performance ratings do not include the effects of appurtenances.

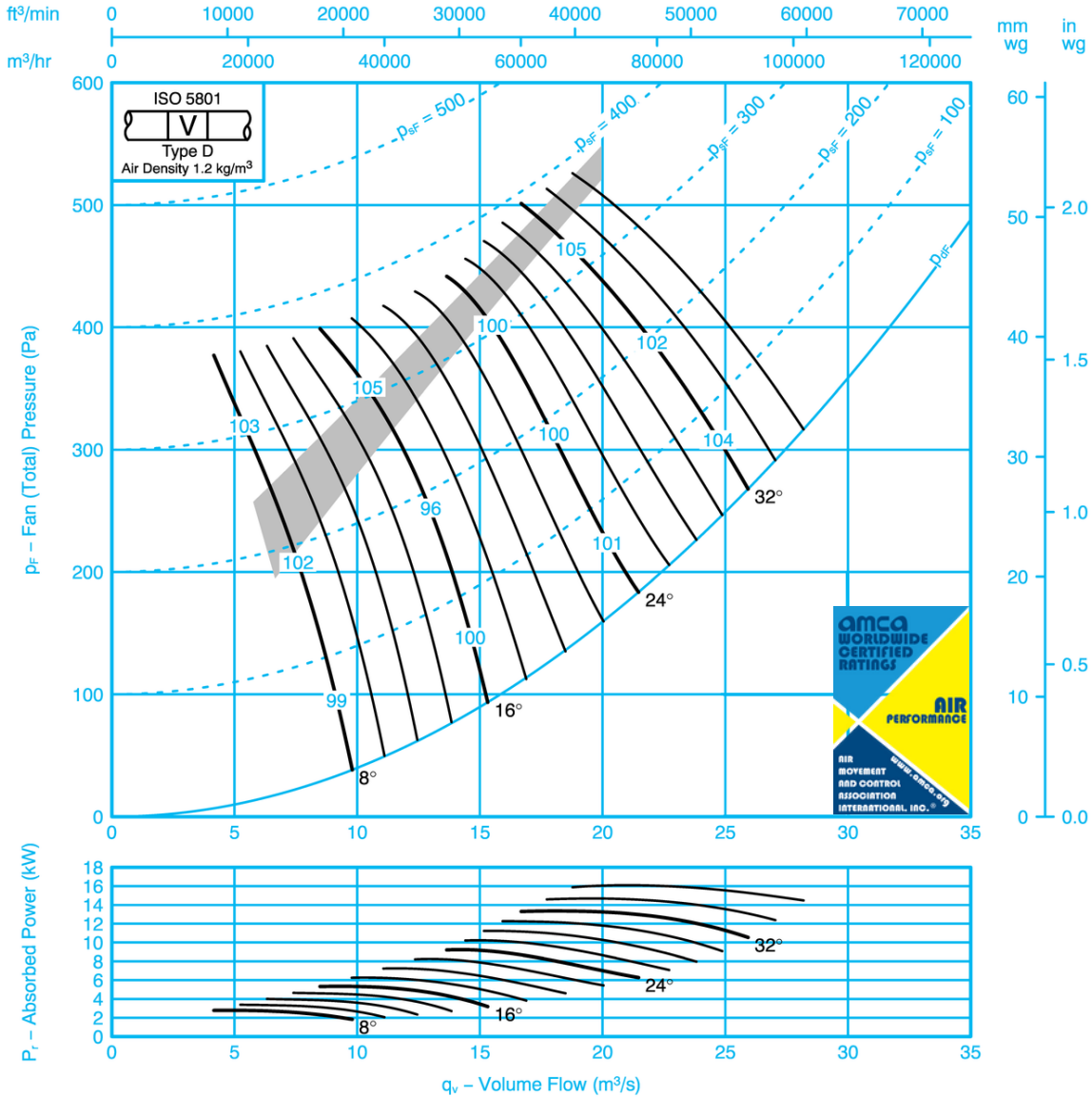

Sound Data ISO 5136

Single figures on performance curves are overall inlet sound power levels, derived from measurements taken in Woods laboratory specifically under ducted conditions. For sound power levels in eight octave bands, apply the following corrections to the overall level. Use upper corrections when operating point is above shaded area, or lower corrections when operating point is below shaded area.

Inlet Levels									Outlet Levels								
Pitch Angle	Octave Band Centre Frequency (Hz)								Pitch Angle	Octave Band Centre Frequency (Hz)							
	63	125	250	500	1k	2k	4k	8k		63	125	250	500	1k	2k	4k	8k
8	-20	-11	-6	-3	-10	-18	-26	-32	8	-19	-8	-6	-3	-11	-18	-24	-31
	-22	-12	-10	-3	-7	-13	-18	-27		-18	-9	-10	-2	-7	-13	-16	-25
16	-20	-9	-6	-4	-9	-17	-25	-31	16	-16	-7	-5	-4	-11	-18	-24	-30
	-16	-7	-8	-5	-7	-11	-15	-23		-12	-5	-7	-4	-8	-11	-14	-22
24-36	-8	-7	-7	-7	-10	-13	-18	-24	24-36	-5	-5	-5	-6	-10	-13	-17	-23
	-8	-6	-7	-7	-10	-13	-15	-22		-5	-4	-5	-6	-9	-12	-14	-21



Performance Data ISO 5801

Performance shown is for installations type D – Ducted inlet, Ducted outlet. Performance ratings do not include the effects of appurtenances.

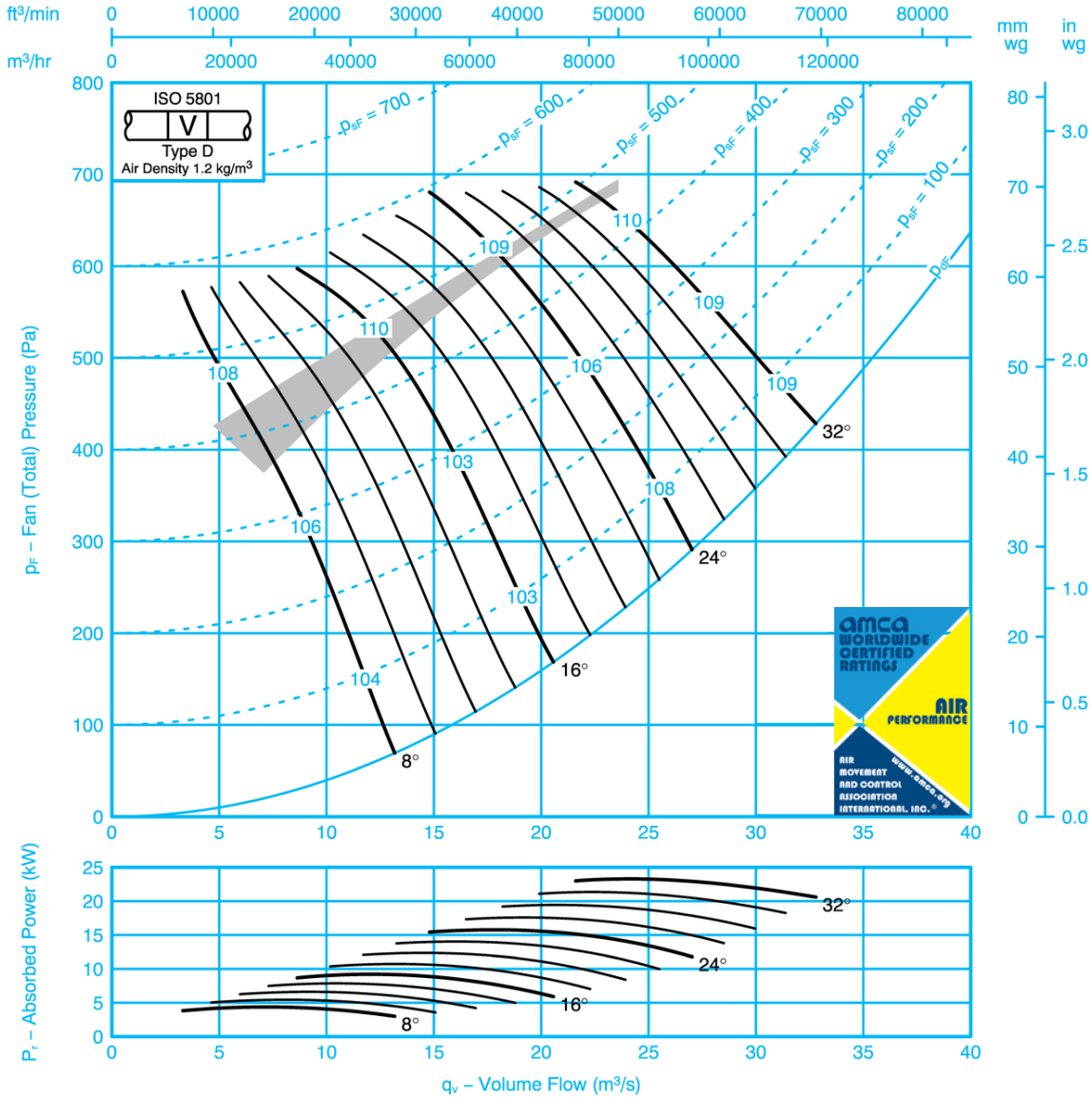

If it is intended to run this fan in reverse for other than emergency operation, please refer to Woods Air Movement.

Sound Data ISO 5136

Single figures on performance curves are overall inlet sound power levels, derived from measurements taken in Woods laboratory specifically under ducted conditions. For sound power levels in eight octave bands, apply the following corrections to the overall level. Use upper corrections when operating point is above shaded area, or lower corrections when operating point is below shaded area.

Inlet Levels								Outlet Levels									
Pitch Angle	Octave Band Centre Frequency (Hz)								Pitch Angle	Octave Band Centre Frequency (Hz)							
	63	125	250	500	1k	2k	4k	8k		63	125	250	500	1k	2k	4k	8k
8	-16	-10	-5	-4	-9	-17	-22	-27	8	-15	-7	-4	-4	-9	-17	-23	-26
	-13	-14	-10	-4	-5	-11	-16	-21		-12	-11	-10	-4	-5	-10	-17	-20
16	-11	-11	-8	-5	-6	-11	-18	-24	16	-9	-9	-8	-5	-6	-11	-18	-23
	-6	-7	-6	-9	-9	-12	-15	-20		-4	-5	-6	-9	-9	-12	-15	-19
24-32	-8	-9	-7	-6	-7	-14	-17	-20	24-32	-6	-7	-6	-6	-7	-13	-17	-19
	-6	-7	-6	-9	-10	-14	-16	-19		-4	-5	-5	-9	-10	-13	-17	-18



Performance Data ISO 5801

Performance shown is for installations type D – Ducted inlet, Ducted outlet. Performance ratings do not include the effects of appurtenances.

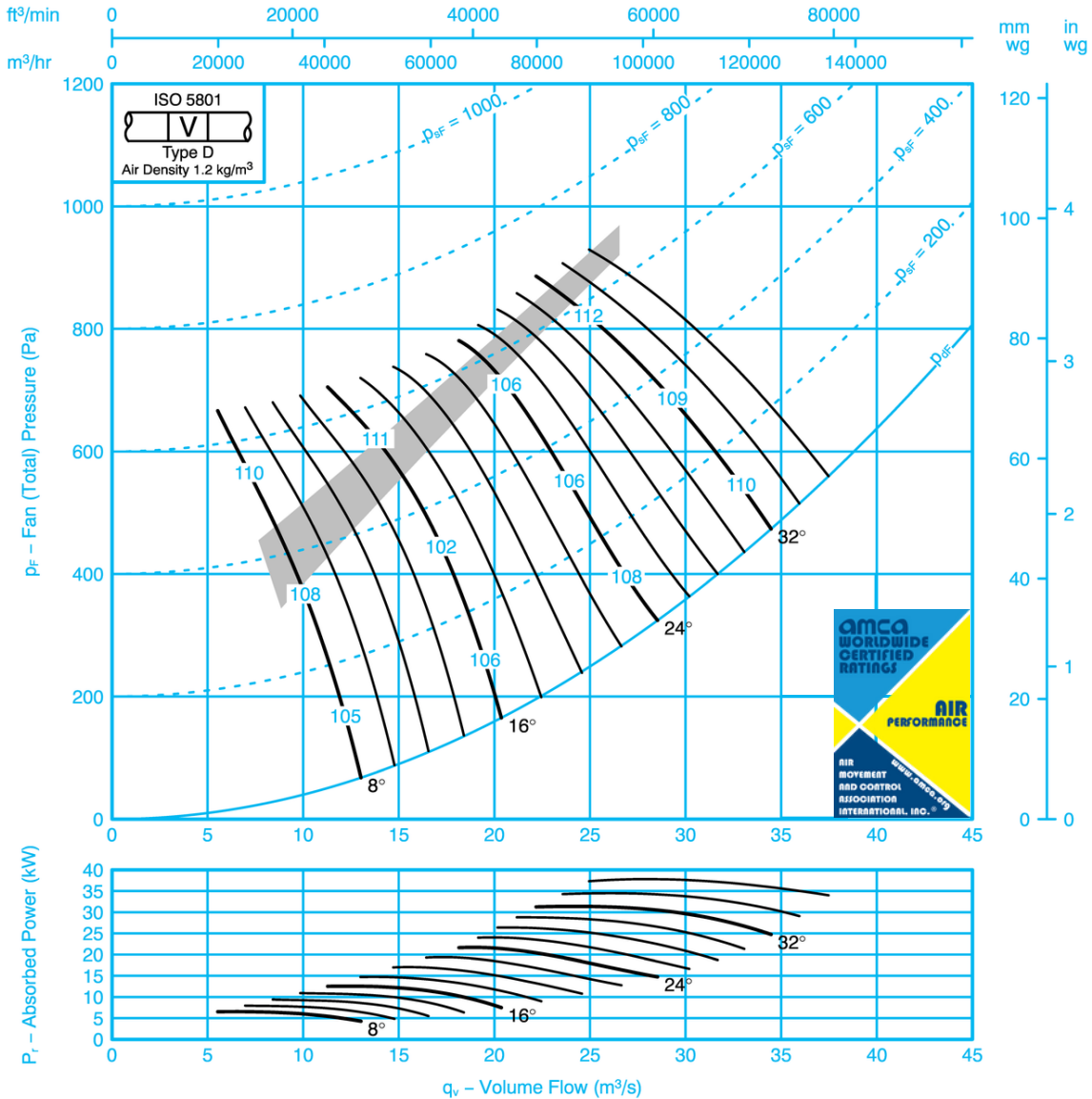

If it is intended to run this fan in reverse for other than emergency operation, please refer to Woods Air Movement.

Sound Data ISO 5136

Single figures on performance curves are overall inlet sound power levels, derived from measurements taken in Woods laboratory specifically under ducted conditions. For sound power levels in eight octave bands, apply the following corrections to the overall level. Use upper corrections when operating point is above shaded area, or lower corrections when operating point is below shaded area.

Inlet Levels									Outlet Levels								
Pitch Angle	Octave Band Centre Frequency (Hz)								Pitch Angle	Octave Band Centre Frequency (Hz)							
	63	125	250	500	1k	2k	4k	8k		63	125	250	500	1k	2k	4k	8k
8	-23	-14	-6	-3	-7	-15	-23	-29	8	-21	-11	-6	-3	-7	-15	-22	-28
	-21	-14	-10	-5	-4	-11	-16	-22		-17	-11	-9	-5	-4	-11	-15	-20
16	-22	-15	-7	-4	-6	-14	-22	-28	16	-18	-12	-6	-4	-7	-14	-21	-28
	-17	-8	-9	-6	-5	-9	-14	-19		-13	-5	-8	-5	-7	-10	-12	-18
24-36	-9	-7	-7	-7	-8	-13	-16	-22	24-36	-6	-4	-6	-6	-7	-12	-15	-21
	-8	-6	-7	-8	-8	-12	-14	-19		-5	-4	-6	-7	-8	-12	-13	-18



FAN CODE: 125JM/50/6/12/...
 1250mm 1150 rev/min 12 Blades 60 Hz

Performance Data ISO 5801

Performance shown is for installations type D – Ducted inlet, Ducted outlet. Performance ratings do not include the effects of appurtenances.

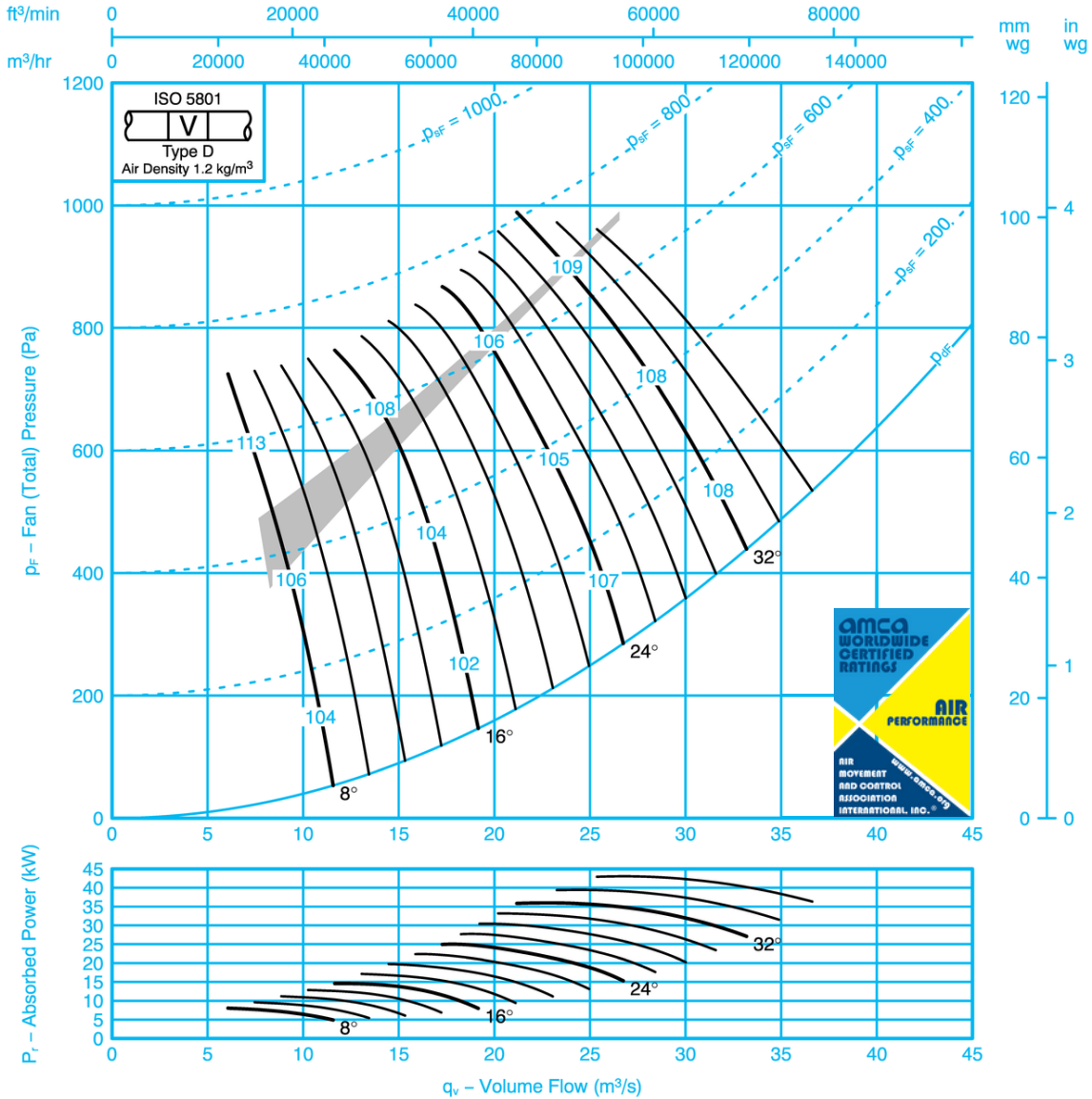

Sound Data ISO 5136

Single figures on performance curves are overall inlet sound power levels, derived from measurements taken in Woods laboratory specifically under ducted conditions. For sound power levels in eight octave bands, apply the following corrections to the overall level. Use upper corrections when operating point is above shaded area, or lower corrections when operating point is below shaded area.

Inlet Levels									Outlet Levels								
Pitch Angle	Octave Band Centre Frequency (Hz)								Pitch Angle	Octave Band Centre Frequency (Hz)							
	63	125	250	500	1k	2k	4k	8k		63	125	250	500	1k	2k	4k	8k
8	-19	-15	-6	-5	-5	-11	-18	-25	8	-15	-13	-5	-6	-5	-9	-15	-23
	-17	-14	-4	-6	-6	-11	-16	-22		-13	-12	-3	-8	-6	-9	-14	-20
16	-14	-13	-6	-5	-5	-11	-18	-25	16	-12	-12	-4	-5	-5	-10	-16	-23
	-11	-12	-3	-8	-8	-12	-16	-21		-8	-10	-1	-8	-8	-10	-13	-19
24-36	-8	-10	-6	-8	-8	-13	-15	-20	24-36	-5	-8	-4	-8	-9	-11	-13	-17
	-8	-9	-5	-9	-9	-12	-15	-20		-5	-7	-3	-9	-9	-10	-12	-18



Performance Data ISO 5801

Performances shown is for installation type D – Ducted inlet, Ducted outlet. Performance ratings do not include the effects of appurtenances.

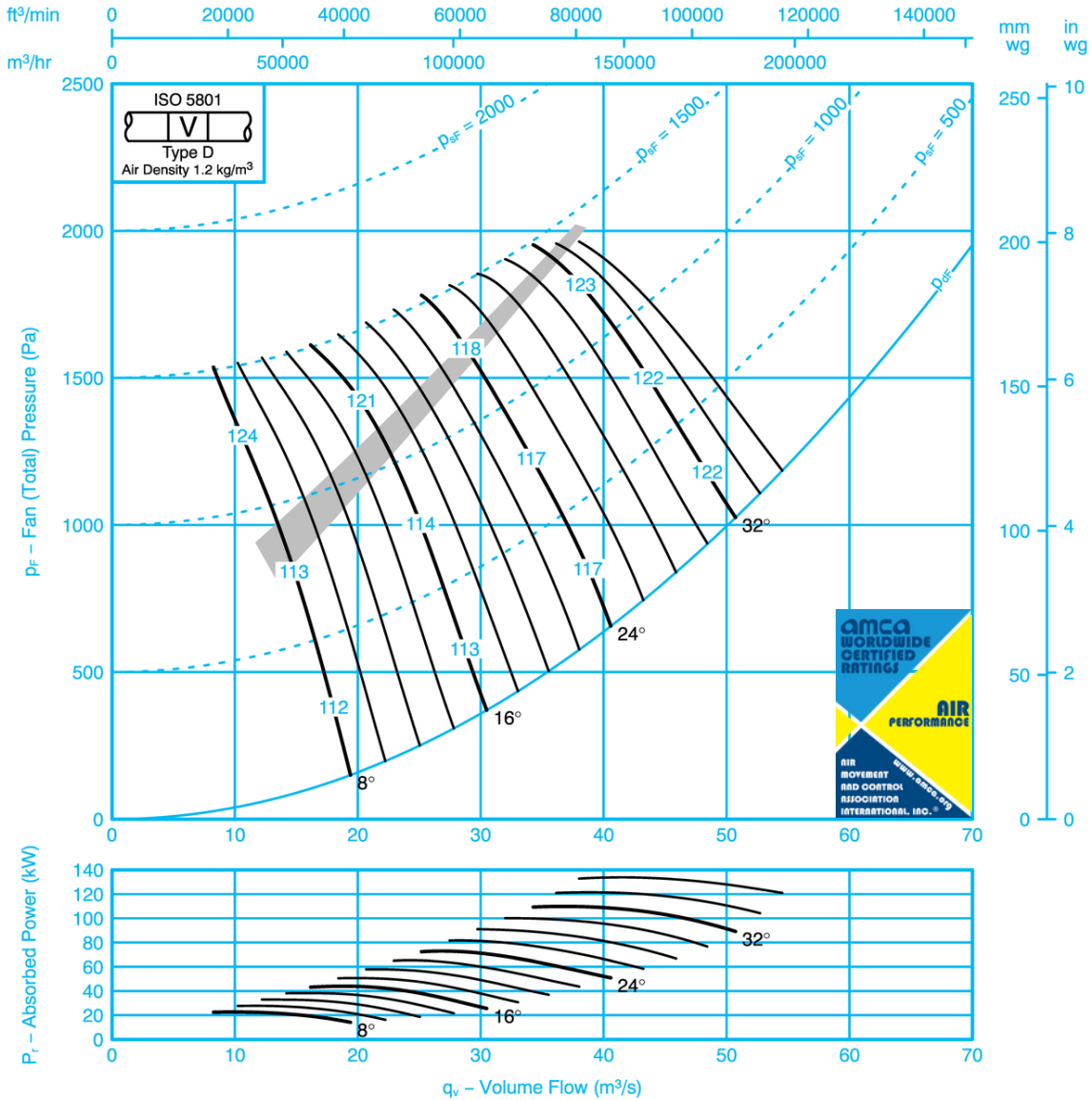

If it is intended to run this fan in reverse for other than emergency operation, please refer to Woods Air Movement.

Sound Data ISO 5136

Single figures on performance curves are overall inlet sound power levels, derived from measurements taken in Woods laboratory specifically under ducted conditions. For sound power levels in eight octave bands, apply the following corrections to the overall level. Use upper corrections when operating point is above shaded area, or lower corrections when operating point is below shaded area.

Inlet Levels									Outlet Levels								
Pitch Angle	Octave Band Centre Frequency (Hz)								Pitch Angle	Octave Band Centre Frequency (Hz)							
	63	125	250	500	1k	2k	4k	8k		63	125	250	500	1k	2k	4k	8k
8	-21	-15	-11	-7	-3	-8	-15	-21	8	-18	-14	-9	-7	-3	-6	-14	-20
	-15	-11	-6	-9	-6	-8	-12	-14		-13	-10	-4	-8	-5	-6	-11	-13
16	-18	-13	-7	-5	-5	-11	-17	-23	16	-15	-12	-5	-4	-5	-10	-16	-22
	-14	-10	-4	-7	-9	-11	-14	-16		-11	-9	-2	-7	-8	-10	-13	-15
24-36	-9	-8	-7	-7	-9	-12	-16	-19	24-36	-6	-7	-5	-6	-8	-11	-15	-18
	-11	-8	-5	-6	-10	-12	-15	-19		-7	-7	-3	-5	-9	-11	-14	-17



FAN CODE: 125JM/50/4/12/...
 1250mm 1765 rev/min 12 Blades 60 Hz

Performance Data ISO 5801

Performance shown is for installations type D – Ducted inlet, Ducted outlet. Performance ratings do not include the effects of appurtenances.

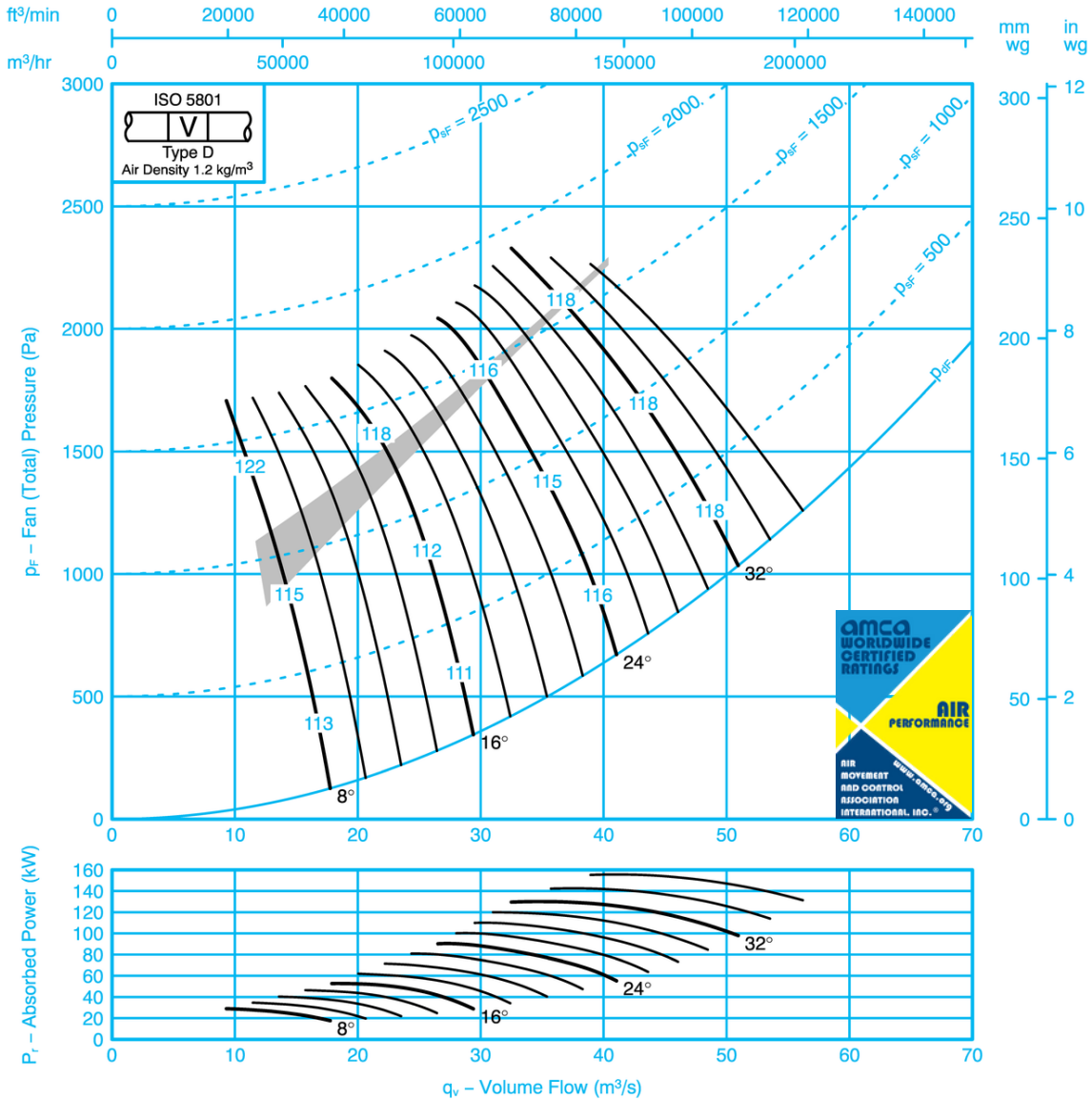

If it is intended to run this fan in reverse for other than emergency operation, please refer to Woods Air Movement.

Sound Data ISO 5136

Single figures on performance curves are overall inlet sound power levels, derived from measurements taken in Woods laboratory specifically under ducted conditions. For sound power levels in eight octave bands, apply the following corrections to the overall level. Use upper corrections when operating point is above shaded area, or lower corrections when operating point is below shaded area.

Inlet Levels								Outlet Levels									
Pitch Angle	Octave Band Centre Frequency (Hz)							Pitch Angle	Octave Band Centre Frequency (Hz)								
	63	125	250	500	1k	2k	4k		8k	63	125	250	500	1k	2k	4k	8k
8	-19	-20	-8	-8	-4	-7	-14	-21	8	-16	-18	-6	-8	-3	-5	-12	-18
	-17	-17	-6	-8	-5	-8	-14	-18		-14	-15	-4	-8	-5	-6	-11	-16
16	-15	-15	-9	-6	-5	-7	-15	-21	16	-12	-13	-7	-5	-5	-5	-11	-19
	-12	-12	-4	-9	-8	-9	-13	-18		-9	-10	-1	-8	-8	-8	-10	-15
24-36	-9	-9	-7	-8	-8	-10	-14	-17	24-36	-6	-6	-6	-7	-8	-8	-11	-15
	-9	-8	-6	-9	-9	-10	-14	-17		-6	-6	-4	-8	-9	-8	-11	-14

SK12027

WAM_DC_00073GB_60HZ JM AEROFOIL
 January 2024



FAN CODE: 140JM/40/10/6/...
 1400mm 690 rev/min 6 Blades 60 Hz

Performance Data ISO 5801

Performances shown is for installations type C—Ducted inlet, Ducted outlet. Performance ratings do not include the effects of appurtenances.

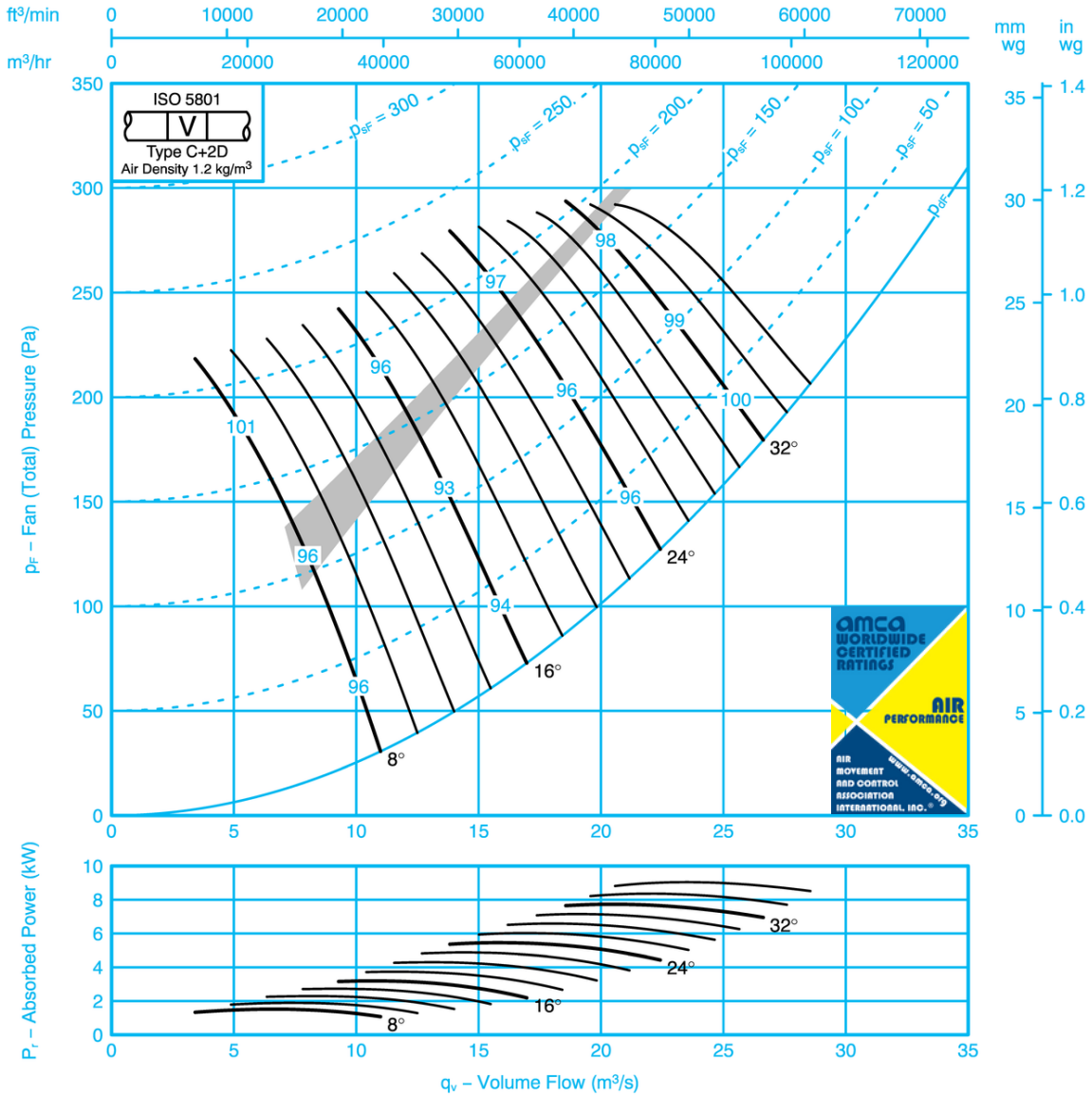

Sound Data ISO 5136

Single figures on performance curves are overall inlet sound power levels, derived from measurements taken in Woods laboratory specifically under ducted conditions. For sound power levels in eight octave bands, apply the following corrections to the overall level. Use upper corrections when operating point is above shaded area, or lower corrections when operating point is below shaded area.

Inlet Levels									Outlet Levels								
Pitch Angle	Octave Band Centre Frequency (Hz)								Pitch Angle	Octave Band Centre Frequency (Hz)							
	63	125	250	500	1k	2k	4k	8k		63	125	250	500	1k	2k	4k	8k
8	-19	-13	-7	-3	-8	-11	-18	-28	8	-16	-11	-6	-3	-7	-9	-17	-27
	-17	-11	-10	-6	-6	-6	-14	-26		-14	-9	-10	-5	-5	-5	-13	-25
16	-15	-10	-7	-3	-9	-15	-20	-23	16	-12	-9	-6	-3	-9	-14	-18	-22
	-9	-6	-8	-9	-10	-7	-14	-22		-6	-4	-7	-9	-10	-7	-13	-21
24-36	-9	-5	-7	-7	-10	-14	-16	-17	24-36	-7	-4	-6	-6	-10	-13	-14	-15
	-8	-5	-7	-8	-12	-14	-15	-17		-5	-4	-6	-6	-12	-13	-13	-15

SK12049

WAM_DC_00073GB_60HZ JM AEROFOIL
 January 2024



FAN CODE: 140JM/40/10/9/...
 1400mm 690 rev/min 9 Blades 60 Hz

Performance Data ISO 5801

Performances shown is for installation type C – Ducted inlet, Ducted outlet. Performance ratings do not include the effects of appurtenances.

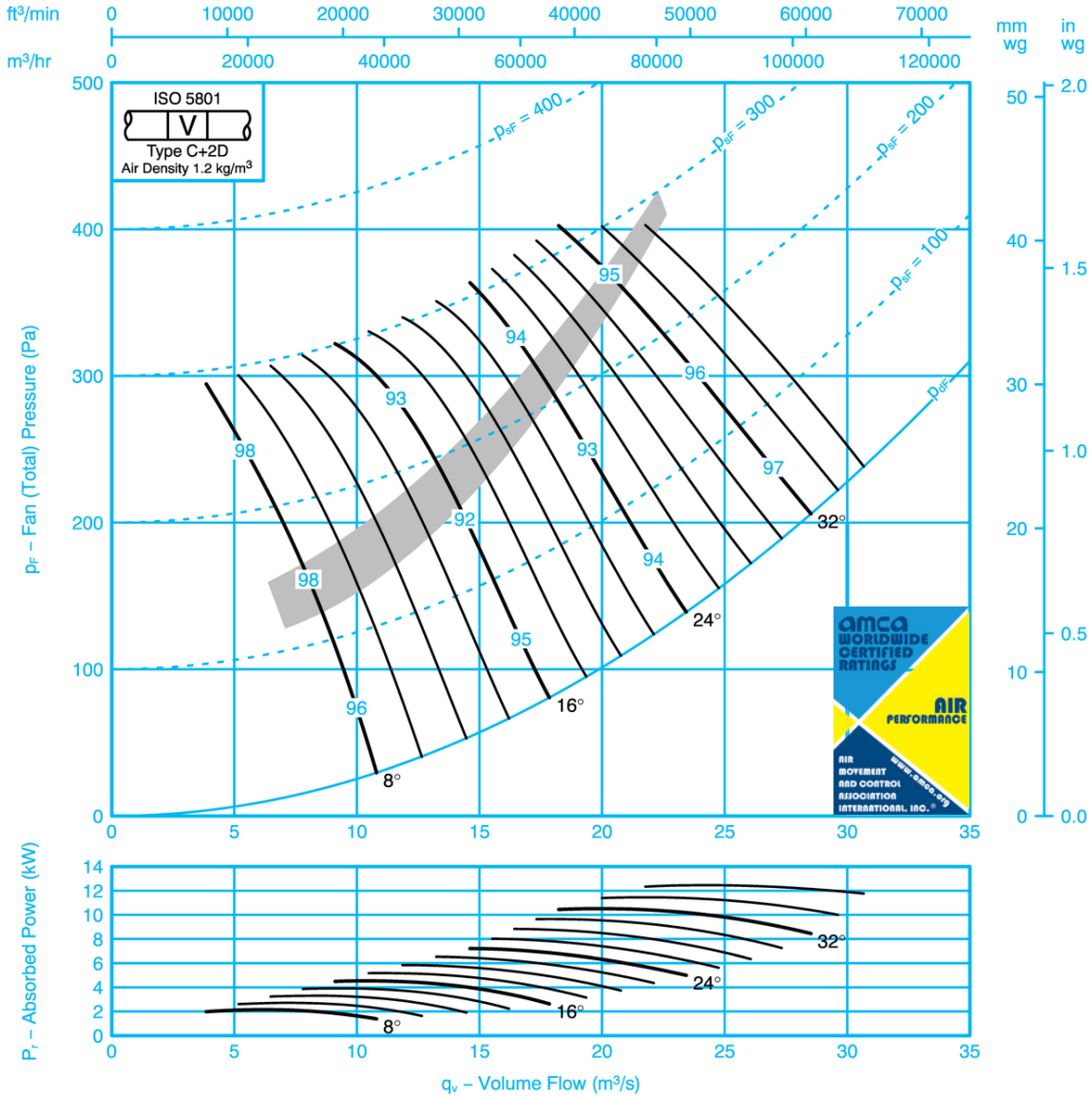

Sound Data ISO 5136

Single figures on performance curves are overall inlet sound power levels, derived from measurements taken in Woods laboratory specifically under ducted conditions. For sound power levels in eight octave bands, apply the following corrections to the overall level. Use upper corrections when operating point is above shaded area, or lower corrections when operating point is below shaded area.

Inlet Levels									Outlet Levels								
Pitch Angle	Octave Band Centre Frequency (Hz)								Pitch Angle	Octave Band Centre Frequency (Hz)							
	63	125	250	500	1k	2k	4k	8k		63	125	250	500	1k	2k	4k	8k
8	-17	-13	-8	-3	-7	-11	-20	-27	8	-14	-10	-7	-2	-6	-10	-20	-26
	-18	-13	-11	-6	-7	-4	-14	-24		-15	-10	-10	-5	-5	-3	-14	-23
16	-9	-9	-8	-6	-8	-9	-14	-18	16	-5	-7	-7	-6	-7	-8	-12	-17
	-13	-9	-10	-8	-8	-4	-13	-21		-9	-7	-8	-8	-7	-4	-13	-19
24-36	-7	-7	-8	-7	-9	-13	-15	-14	24-36	-4	-3	-6	-7	-9	-12	-13	-13
	-8	-7	-7	-8	-10	-12	-16	-17		-3	-3	-4	-7	-8	-11	-14	-16

SK12050

WAM_DC_00073GB_60HZ_JM AEROFOIL
 January 2024



FAN CODE: 140JM/40/8/6/...
 1400mm 865 rev/min 6 Blades 60 Hz

Performance Data ISO 5801

Performances shown is for installation type C – Ducted inlet, Ducted outlet. Performance ratings do not include the effects of appurtenances.

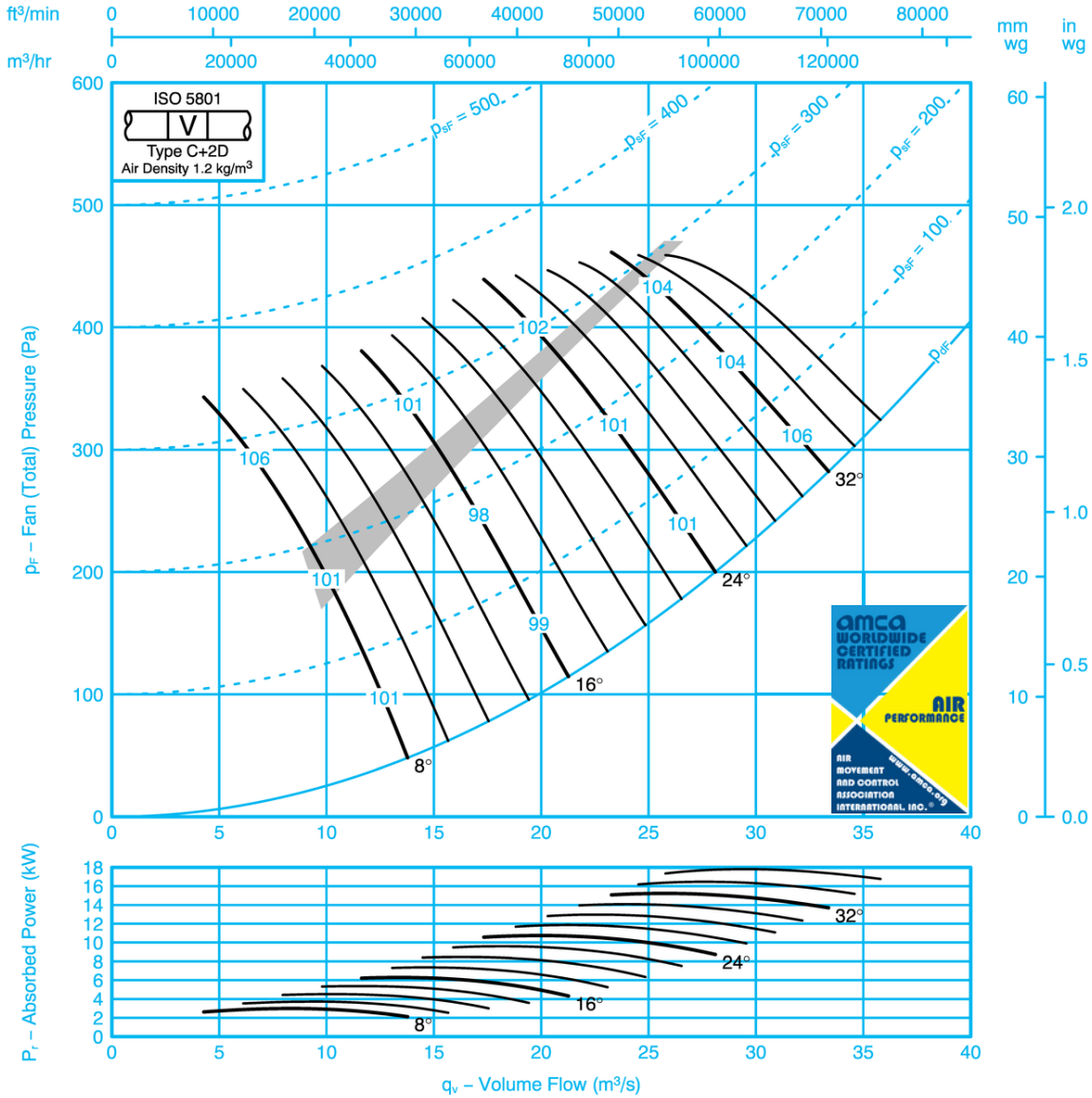

If it is intended to run this fan in reverse for other than emergency operation, please refer to Woods Air Movement.

Sound Data ISO 5136

Single figures on performance curves are overall inlet sound power levels, derived from measurements taken in Woods laboratory specifically under ducted conditions. For sound power levels in eight octave bands, apply the following corrections to the overall level. Use upper corrections when operating point is above shaded area, or lower corrections when operating point is below shaded area.

Inlet Levels									Outlet Levels								
Pitch Angle	Octave Band Centre Frequency (Hz)								Pitch Angle	Octave Band Centre Frequency (Hz)							
	63	125	250	500	1k	2k	4k	8k		63	125	250	500	1k	2k	4k	8k
8	-17	-14	-10	-3	-6	-11	-14	-26	8	-14	-12	-10	-2	-6	-9	-13	-25
	-15	-12	-12	-7	-6	-6	-9	-24		-12	-10	-11	-6	-5	-5	-8	-23
16	-14	-11	-10	-3	-8	-13	-18	-23	16	-11	-9	-9	-3	-7	-13	-16	-22
	-8	-7	-9	-9	-11	-9	-10	-21		-4	-5	-8	-9	-11	-8	-9	-20
24-36	-8	-6	-8	-7	-9	-13	-16	-17	24-36	-5	-5	-7	-6	-9	-12	-14	-16
	-6	-6	-8	-8	-11	-14	-15	-17		-3	-5	-6	-6	-11	-13	-13	-16

SK12035

WAM_DC_00073GB_60HZ JM AEROFOIL
 January 2024



FAN CODE: 140JM/40/8/9/...
 1400mm 865 rev/min 9 Blades 60 Hz

Performance Data ISO 5801

Performances shown is for installations type C – Ducted inlet, Ducted outlet. Performance ratings do not include the effects of appurtenances.

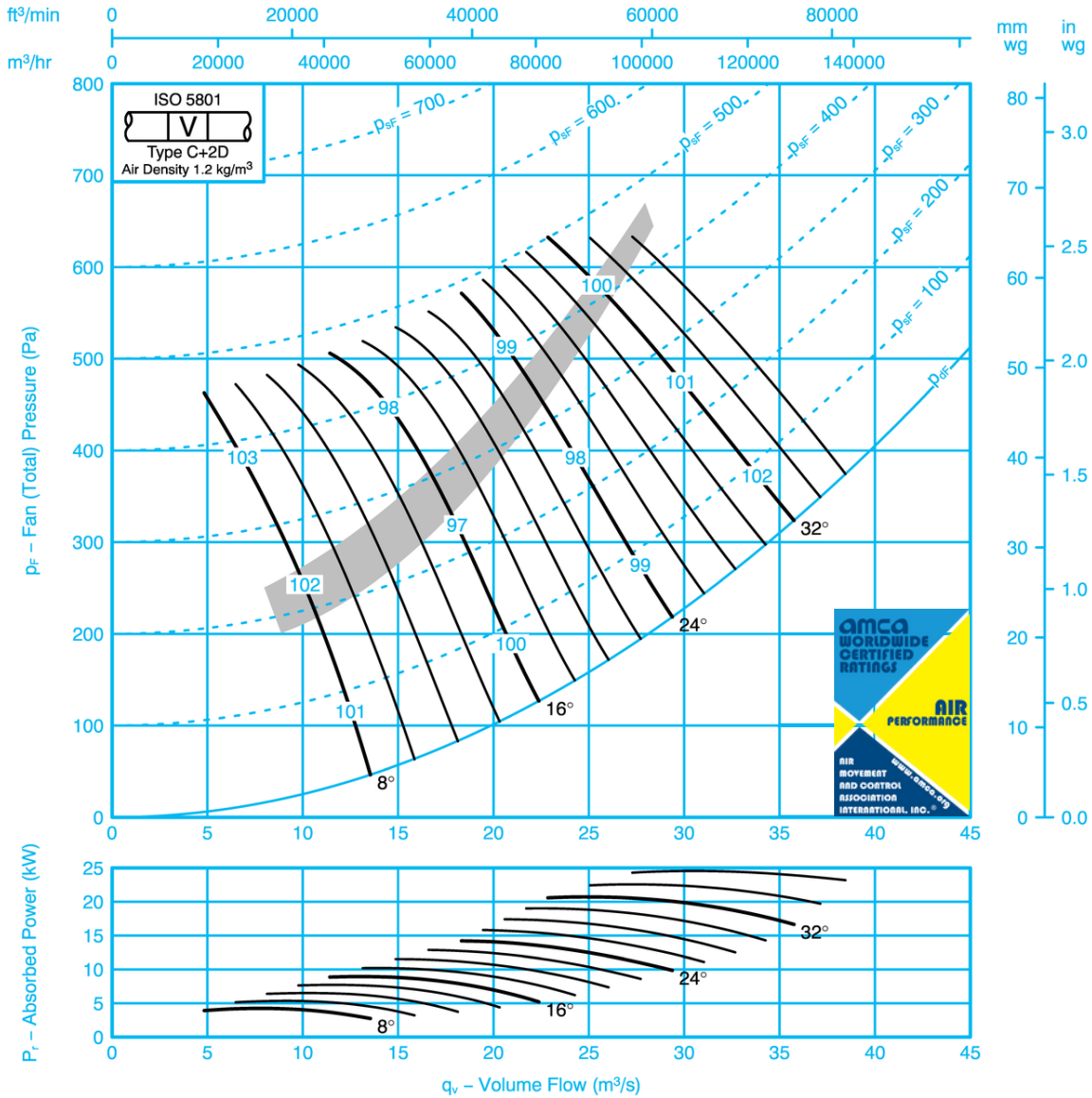

If it is intended to run this fan in reverse for other than emergency operation, please refer to Woods Air Movement.

Sound Data ISO 5136

Single figures on performance curves are overall inlet sound power levels, derived from measurements taken in Woods laboratory specifically under ducted conditions. For sound power levels in eight octave bands, apply the following corrections to the overall level. Use upper corrections when operating point is above shaded area, or lower corrections when operating point is below shaded area.

Inlet Levels									Outlet Levels								
Pitch Angle	Octave Band Centre Frequency (Hz)								Pitch Angle	Octave Band Centre Frequency (Hz)							
	63	125	250	500	1k	2k	4k	8k		63	125	250	500	1k	2k	4k	8k
8	-18	-15	-11	-4	-6	-11	-16	-26	8	-15	-12	-10	-2	-4	-9	-15	-25
	-18	-14	-13	-8	-7	-5	-8	-22		-15	-11	-12	-6	-5	-3	-8	-21
16	-7	-10	-10	-6	-8	-9	-12	-18	16	-4	-7	-10	-6	-7	-9	-10	-17
	-12	-10	-11	-9	-9	-5	-9	-20		-8	-7	-9	-9	-7	-5	-9	-18
24-36	-7	-7	-9	-7	-9	-12	-15	-15	24-36	-3	-4	-7	-7	-8	-11	-14	-14
	-7	-7	-8	-7	-9	-11	-15	-17		-3	-4	-6	-6	-8	-11	-13	-16

SK12036

WAM_DC_00073GB_60HZ JM AEROFOIL
 January 2024



Performance Data ISO 5801

Performances shown is for installations type C—Ducted inlet, Ducted outlet. Performance ratings do not include the effects of appurtenances.

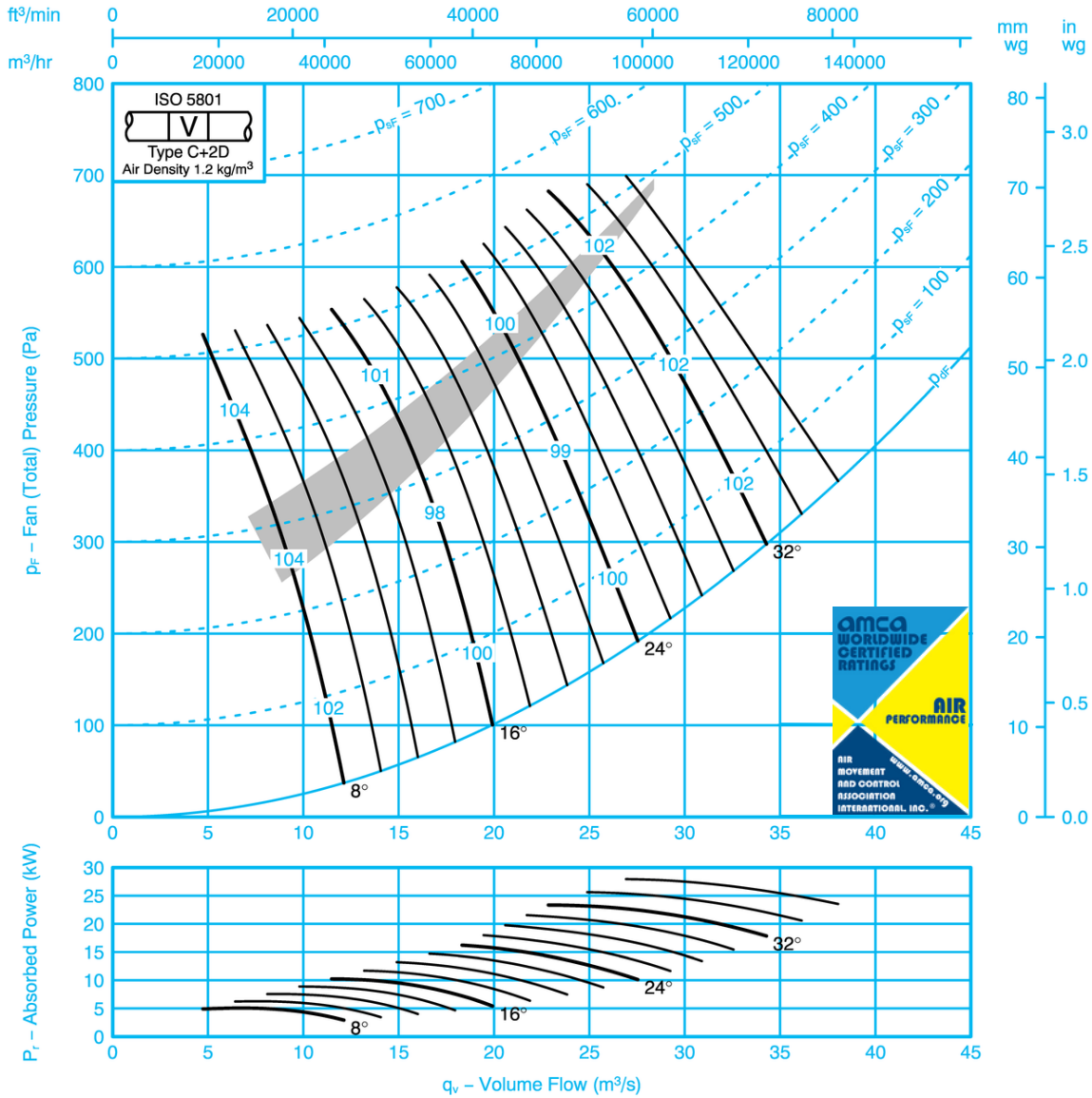

Sound Data ISO 5136

Single figures on performance curves are overall inlet sound power levels, derived from measurements taken in Woods laboratory specifically under ducted conditions. For sound power levels in eight octave bands, apply the following corrections to the overall level. Use upper corrections when operating point is above shaded area, or lower corrections when operating point is below shaded area.

Inlet Levels									Outlet Levels								
Pitch Angle	Octave Band Centre Frequency (Hz)								Pitch Angle	Octave Band Centre Frequency (Hz)							
	63	125	250	500	1k	2k	4k	8k		63	125	250	500	1k	2k	4k	8k
8	-17	-9	-10	-4	-6	-13	-19	-29	8	-14	-7	-10	-3	-5	-11	-17	-27
	-19	-13	-12	-6	-6	-7	-11	-23		-16	-11	-12	-5	-4	-5	-9	-21
16	-16	-13	-7	-3	-8	-15	-23	-27	16	-13	-11	-6	-3	-7	-14	-20	-26
	-11	-7	-12	-9	-8	-7	-11	-20		-7	-3	-11	-9	-8	-6	-7	-18
24-36	-5	-6	-10	-8	-9	-13	-16	-16	24-36	-2	-3	-8	-7	-8	-13	-15	-16
	-7	-6	-10	-8	-9	-11	-15	-20		-3	-2	-8	-7	-8	-11	-14	-19



Performance Data ISO 5801

Performance shown is for installations type C – Ducted inlet, Ducted outlet. Performance ratings do not include the effects of appurtenances.

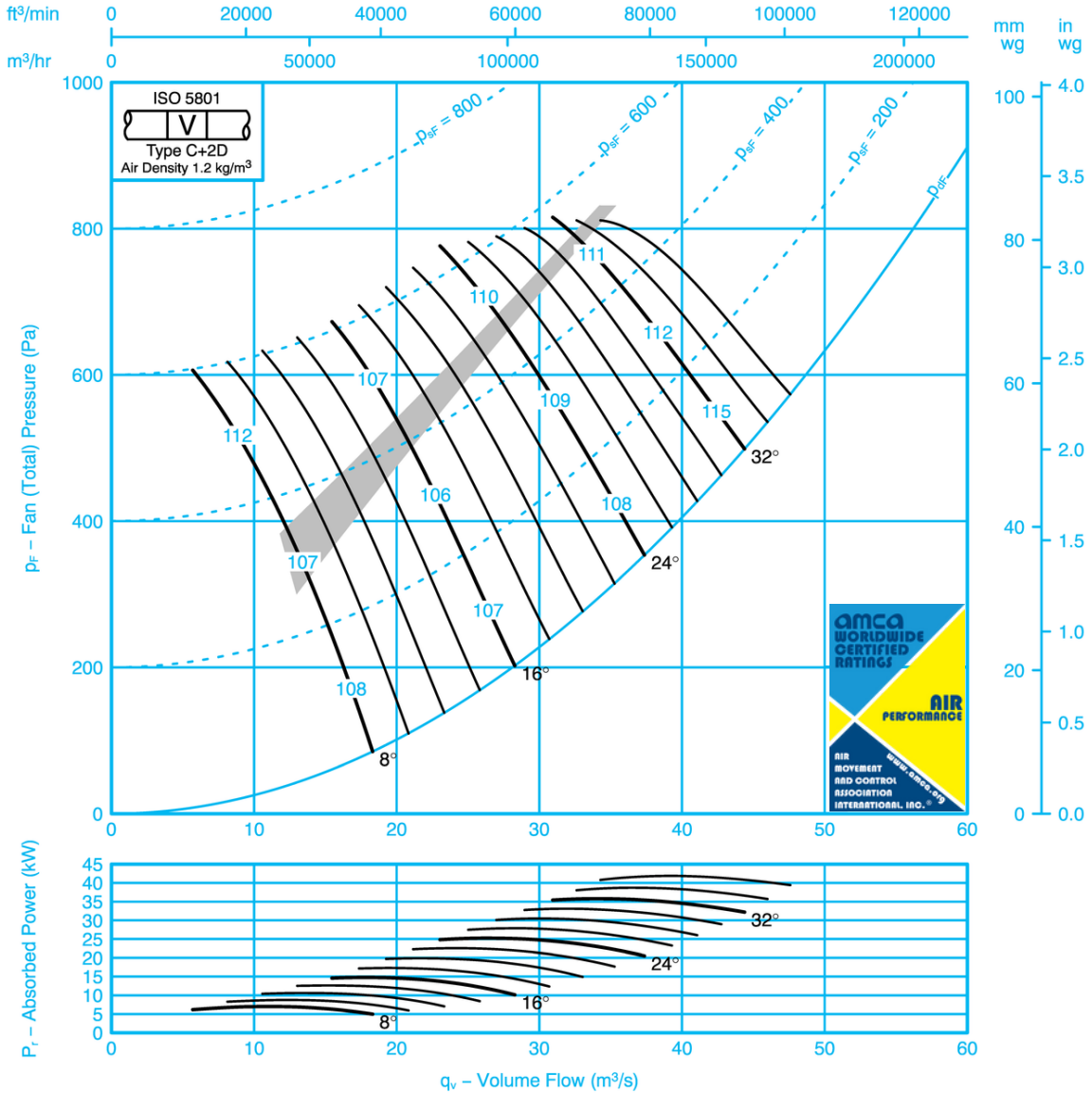

If it is intended to run this fan in reverse for other than emergency operation, please refer to Woods Air Movement.

Sound Data ISO 5136

Single figures on performance curves are overall inlet sound power levels, derived from measurements taken in Woods laboratory specifically under ducted conditions. For sound power levels in eight octave bands, apply the following corrections to the overall level. Use upper corrections when operating point is above shaded area, or lower corrections when operating point is below shaded area.

Inlet Levels								Outlet Levels									
Pitch Angle	Octave Band Centre Frequency (Hz)								Pitch Angle	Octave Band Centre Frequency (Hz)							
	63	125	250	500	1k	2k	4k	8k		63	125	250	500	1k	2k	4k	8k
8	-16	-14	-11	-5	-4	-9	-11	-22	8	-13	-14	-12	-4	-4	-8	-10	-21
	-14	-14	-11	-9	-5	-7	-7	-19		-11	-12	-11	-8	-5	-6	-6	-18
16	-12	-12	-11	-5	-5	-11	-16	-21	16	-10	-11	-10	-5	-4	-11	-14	-20
	-7	-8	-7	-9	-11	-10	-9	-18		-4	-6	-7	-9	-10	-10	-8	-17
24-36	-7	-8	-7	-7	-8	-12	-15	-17	24-36	-5	-6	-6	-6	-8	-11	-13	-15
	-6	-7	-7	-8	-10	-13	-15	-17		-3	-6	-6	-7	-10	-12	-13	-16



Performance Data ISO 5801

Performance shown is for installations type C – Ducted inlet, Ducted outlet. Performance ratings do not include the effects of appurtenances.

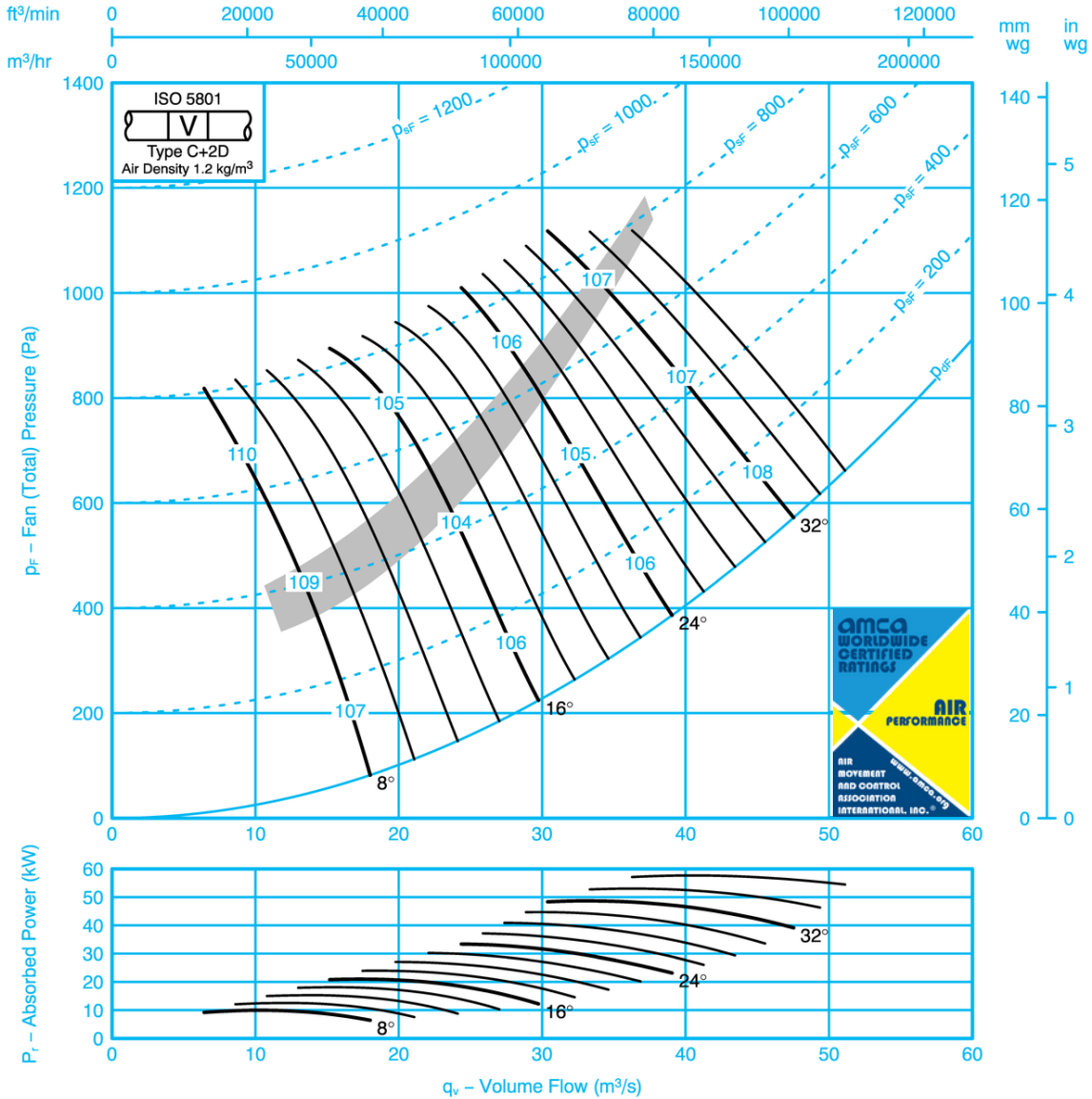

If it is intended to run this fan in reverse for other than emergency operation, please refer to Woods Air Movement.

Sound Data ISO 5136

Single figures on performance curves are overall inlet sound power levels, derived from measurements taken in Woods laboratory specifically under ducted conditions. For sound power levels in eight octave bands, apply the following corrections to the overall level. Use upper corrections when operating point is above shaded area, or lower corrections when operating point is below shaded area.

Inlet Levels									Outlet Levels								
Pitch Angle	Octave Band Centre Frequency (Hz)								Pitch Angle	Octave Band Centre Frequency (Hz)							
	63	125	250	500	1k	2k	4k	8k		63	125	250	500	1k	2k	4k	8k
8	-19	-15	-12	-6	-4	-9	-12	-23	8	-16	-13	-12	-4	-3	-7	-12	-23
	-18	-14	-14	-9	-6	-6	-5	-18		-15	-11	-13	-8	-5	-5	-5	-17
16	-7	-9	-12	-8	-7	-9	-10	-17	16	-3	-7	-11	-8	-6	-9	-8	-16
	-11	-9	-12	-9	-9	-7	-6	-17		-8	-7	-11	-9	-8	-6	-6	-15
24-36	-6	-7	-10	-8	-8	-11	-15	-15	24-36	-2	-4	-8	-7	-8	-10	-13	-14
	-7	-7	-9	-7	-9	-11	-13	-17		-2	-3	-7	-6	-8	-10	-11	-16



FAN CODE: 140JM/50/6/12/...
 1400mm 1150 rev/min 12 Blades 60 Hz

Performance Data ISO 5801

Performance shown is for installations type C—Ducted inlet, Ducted outlet. Performance ratings do not include the effects of appurtenances.

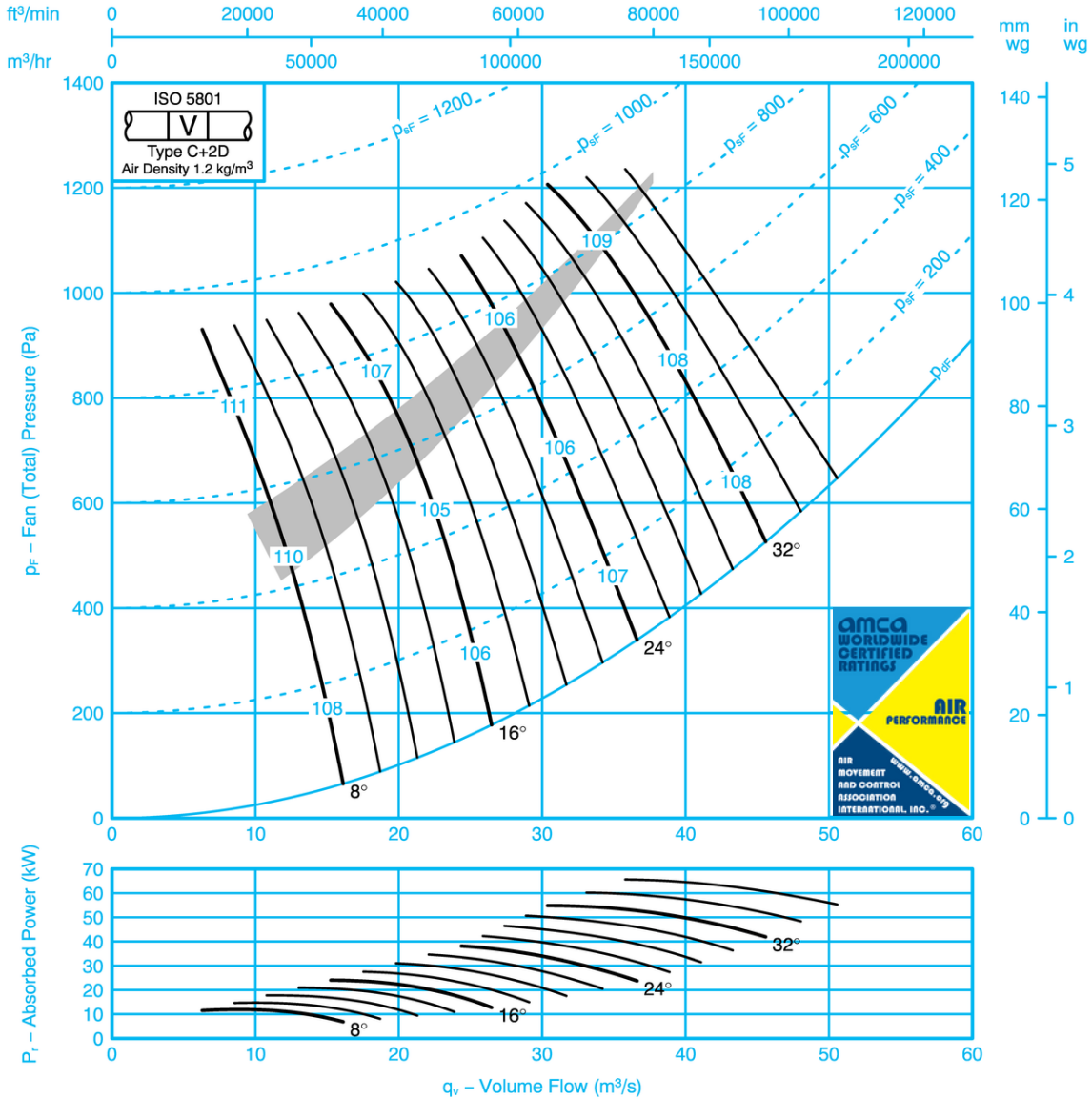

If it is intended to run this fan in reverse for other than emergency operation, please refer to Woods Air Movement.

Sound Data ISO 5136

Single figures on performance curves are overall inlet sound power levels, derived from measurements taken in Woods laboratory specifically under ducted conditions. For sound power levels in eight octave bands, apply the following corrections to the overall level. Use upper corrections when operating point is above shaded area, or lower corrections when operating point is below shaded area.

Inlet Levels									Outlet Levels								
Pitch Angle	Octave Band Centre Frequency (Hz)								Pitch Angle	Octave Band Centre Frequency (Hz)							
	63	125	250	500	1k	2k	4k	8k		63	125	250	500	1k	2k	4k	8k
8	-17	-13	-8	-5	-5	-10	-16	-27	8	-15	-12	-6	-5	-4	-8	-14	-25
	-19	-15	-12	-8	-5	-7	-8	-20		-16	-15	-10	-7	-3	-4	-6	-18
16	-15	-16	-10	-3	-5	-11	-19	-26	16	-12	-14	-8	-3	-4	-11	-17	-25
	-10	-12	-6	-10	-8	-8	-8	-18		-6	-10	-4	-9	-8	-7	-5	-16
24-36	-5	-8	-7	-10	-9	-12	-16	-17	24-36	-2	-5	-5	-9	-8	-12	-15	-17
	-6	-9	-6	-9	-9	-11	-13	-19		-3	-6	-4	-8	-8	-11	-12	-18

SK12042

WAM_DC_00073GB_60HZ JM AEROFOIL
 January 2024



FAN CODE: 160JM/40/10/6/...
 1600mm 690 rev/min 6 Blades 60 Hz

Performance Data ISO 5801

Performance shown is for installations type C – Ducted inlet, Ducted outlet. Performance ratings do not include the effects of appurtenances.

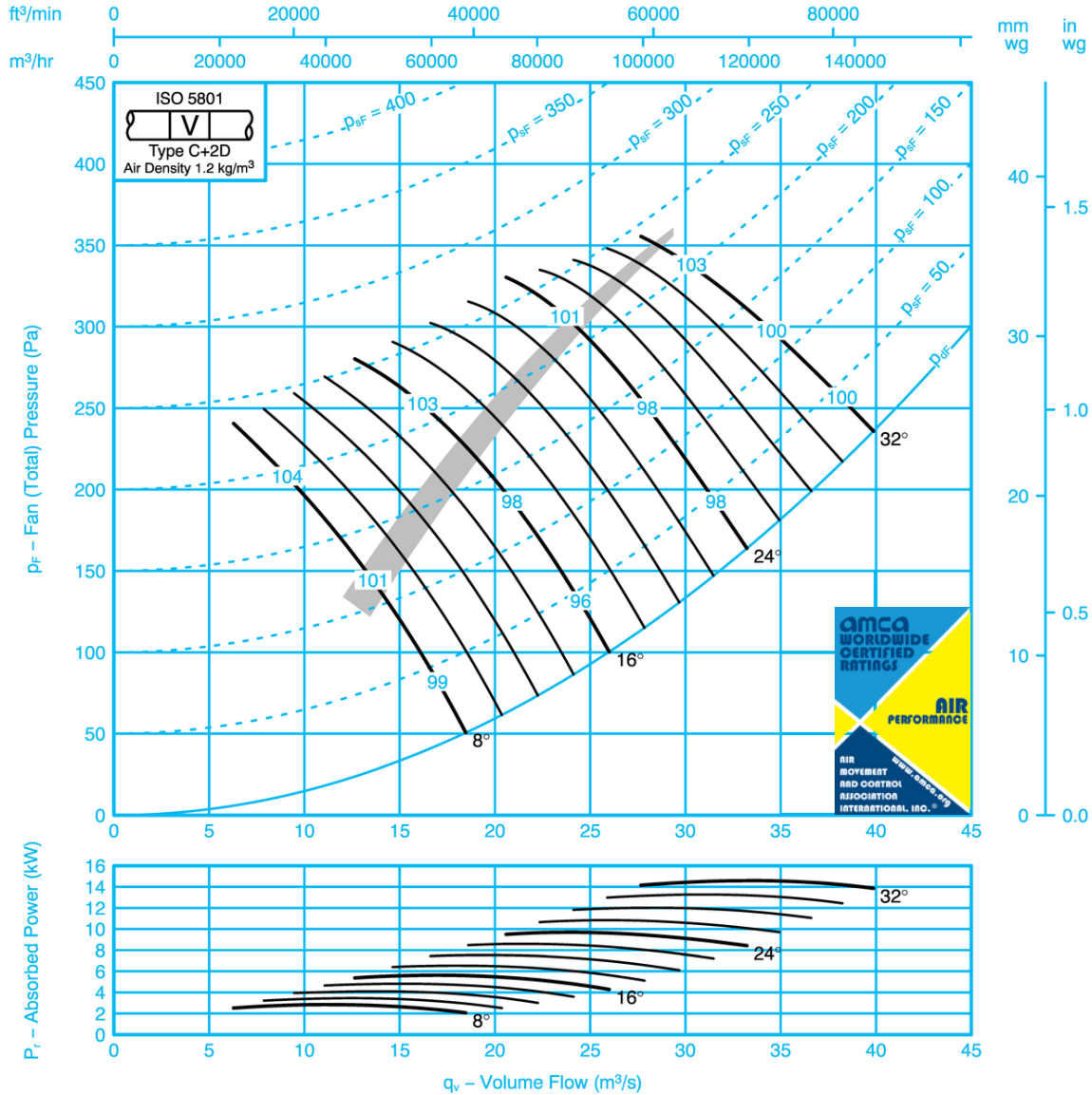

Sound Data ISO 5136

Single figures on performance curves are overall inlet sound power levels, derived from measurements taken in Woods laboratory specifically under ducted conditions. For sound power levels in eight octave bands, apply the following corrections to the overall level. Use upper corrections when operating point is above shaded area, or lower corrections when operating point is below shaded area.

Inlet Levels									Outlet Levels								
Pitch Angle	Octave Band Centre Frequency (Hz)								Pitch Angle	Octave Band Centre Frequency (Hz)							
	63	125	250	500	1k	2k	4k	8k		63	125	250	500	1k	2k	4k	8k
8	-18	-11	-4	-4	-9	-15	-18	-26	8	-15	-9	-4	-4	-8	-13	-17	-25
	-17	-14	-11	-5	-5	-8	-12	-23		-13	-12	-10	-5	-5	-6	-11	-22
16	-16	-13	-9	-4	-7	-11	-14	-17	16	-13	-12	-8	-4	-6	-10	-12	-16
	-11	-9	-9	-7	-8	-8	-10	-15		-8	-7	-9	-7	-7	-8	-9	-14
24-32	-12	-7	-6	-7	-10	-15	-17	-19	24-32	-10	-6	-5	-6	-9	-14	-16	-18
	-9	-7	-8	-7	-8	-11	-12	-13		-7	-6	-7	-6	-8	-10	-10	-12

SK12064

WAM_DC_00073GB_60HZ JM AEROFOIL
 January 2024



FAN CODE: 160JM/40/10/9/...
 1600mm 690 rev/min 9 Blades 60 Hz

Performance Data ISO 5801

Performance shown is for installations type C—Ducted inlet, Ducted outlet. Performance ratings do not include the effects of appurtenances.

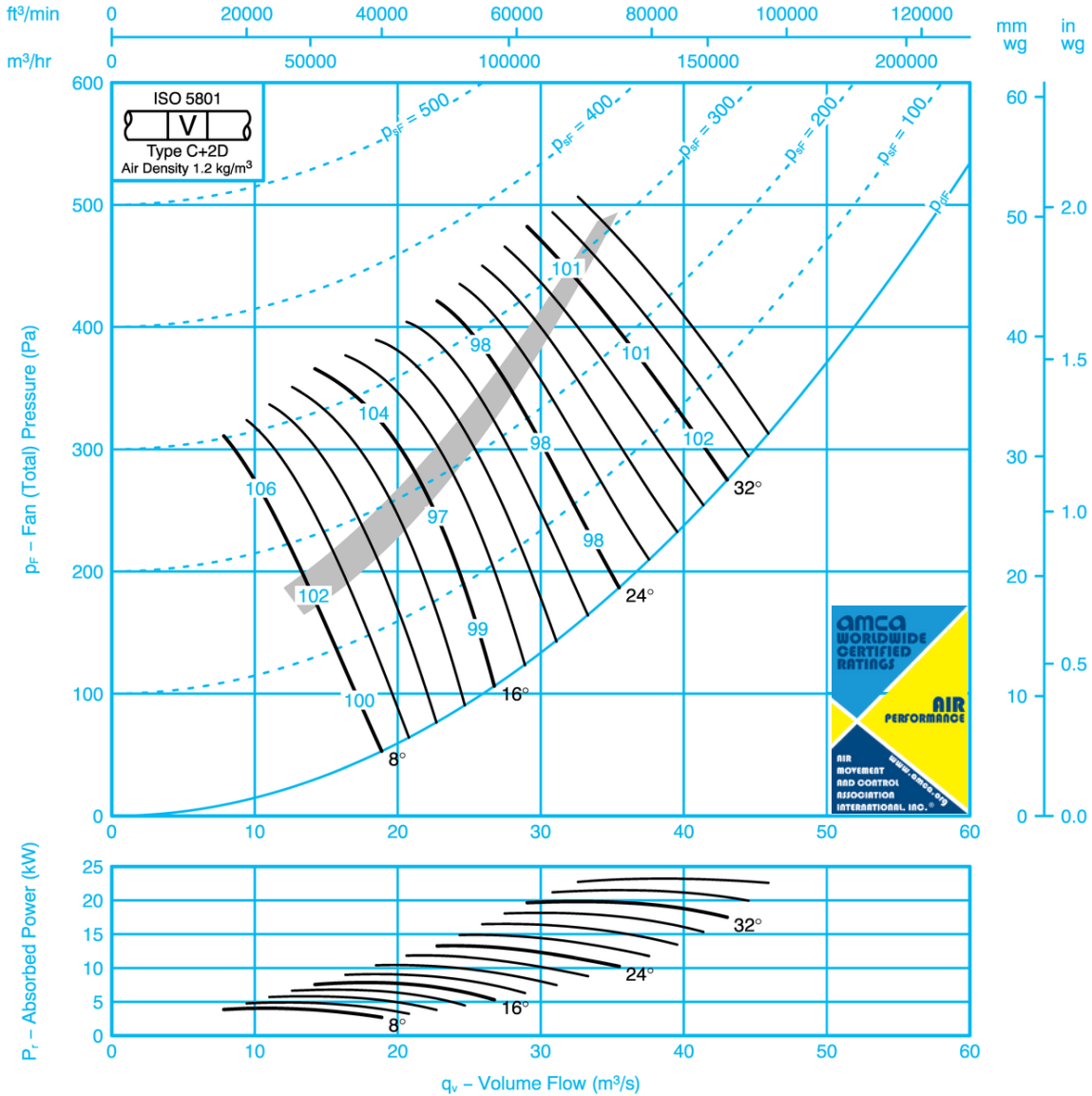

Sound Data ISO 5136

Single figures on performance curves are overall inlet sound power levels, derived from measurements taken in Woods laboratory specifically under ducted conditions. For sound power levels in eight octave bands, apply the following corrections to the overall level. Use upper corrections when operating point is above shaded area, or lower corrections when operating point is below shaded area.

Inlet Levels									Outlet Levels								
Pitch Angle	Octave Band Centre Frequency (Hz)								Pitch Angle	Octave Band Centre Frequency (Hz)							
	63	125	250	500	1k	2k	4k	8k		63	125	250	500	1k	2k	4k	8k
8	-21	-13	-5	-3	-10	-16	-19	-28	8	-18	-10	-4	-2	-9	-14	-19	-28
	-20	-14	-11	-5	-6	-7	-12	-24		-17	-10	-11	-3	-4	-6	-12	-23
16	-19	-14	-5	-3	-9	-14	-18	-22	16	-16	-12	-5	-3	-7	-13	-16	-21
	-13	-7	-10	-9	-8	-7	-9	-18		-9	-4	-9	-9	-7	-6	-9	-16
24-36	-10	-10	-8	-7	-7	-10	-11	-13	24-36	-6	-7	-6	-6	-6	-9	-10	-12
	-8	-8	-8	-8	-8	-10	-11	-13		-4	-4	-6	-7	-7	-10	-9	-12

SK12065

WAM_DC_00073GB_60HZ JM AEROFOIL
 January 2024



FAN CODE: 160JM/50/10/12/...
 1600mm 690 rev/min 12 Blades 60 Hz

Performance Data ISO 5801

Performance shown is for installations type C – Ducted inlet, Ducted outlet. Performance ratings do not include the effects of appurtenances.

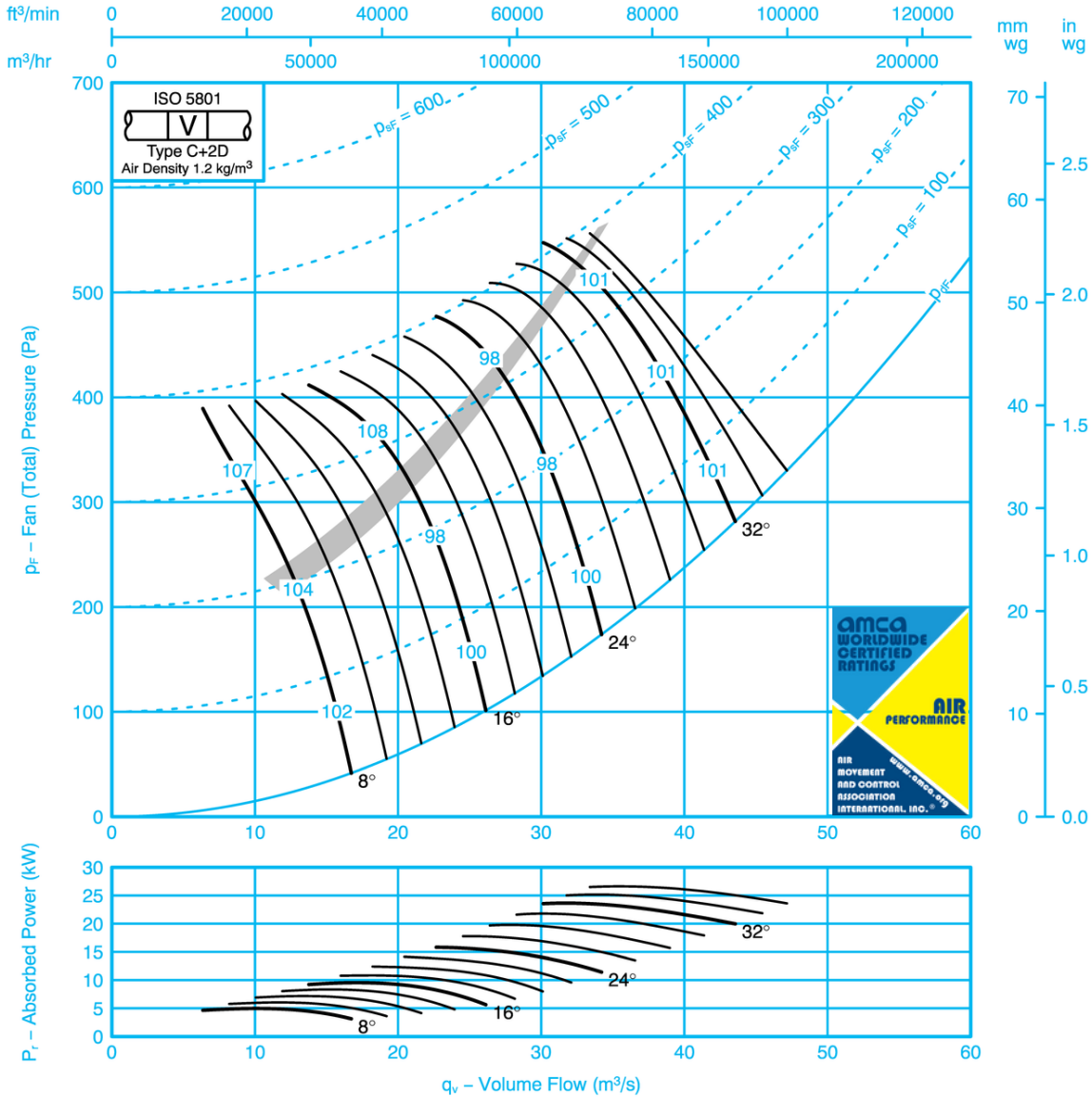

Sound Data ISO 5136

Single figures on performance curves are overall inlet sound power levels, derived from measurements taken in Woods laboratory specifically under ducted conditions. For sound power levels in eight octave bands, apply the following corrections to the overall level. Use upper corrections when operating point is above shaded area, or lower corrections when operating point is below shaded area.

Inlet Levels									Outlet Levels								
Pitch Angle	Octave Band Centre Frequency (Hz)								Pitch Angle	Octave Band Centre Frequency (Hz)							
	63	125	250	500	1k	2k	4k	8k		63	125	250	500	1k	2k	4k	8k
8	-20	-13	-5	-3	-11	-15	-20	-29	8	-18	-10	-5	-2	-10	-12	-19	-27
	-21	-15	-10	-4	-6	-7	-14	-26		-18	-13	-11	-4	-5	-5	-11	-24
16	-18	-14	-8	-4	-6	-11	-16	-22	16	-15	-12	-7	-4	-5	-10	-13	-21
	-14	-10	-12	-8	-7	-5	-9	-18		-11	-7	-11	-8	-7	-4	-6	-16
24-36	-11	-8	-8	-7	-8	-11	-14	-16	24-36	-8	-5	-6	-6	-7	-11	-12	-15
	-8	-8	-9	-8	-8	-9	-12	-15		-4	-3	-7	-7	-7	-9	-11	-14

SK12067

WAM_DC_00073GB_60HZ JM AEROFOIL
 January 2024



FAN CODE: 160JM/40/8/6/...
1600mm 865 rev/min 6 Blades 60 Hz

Performance Data ISO 5801

Performance shown is for installations type C – Ducted inlet, Ducted outlet. Performance ratings do not include the effects of appurtenances.

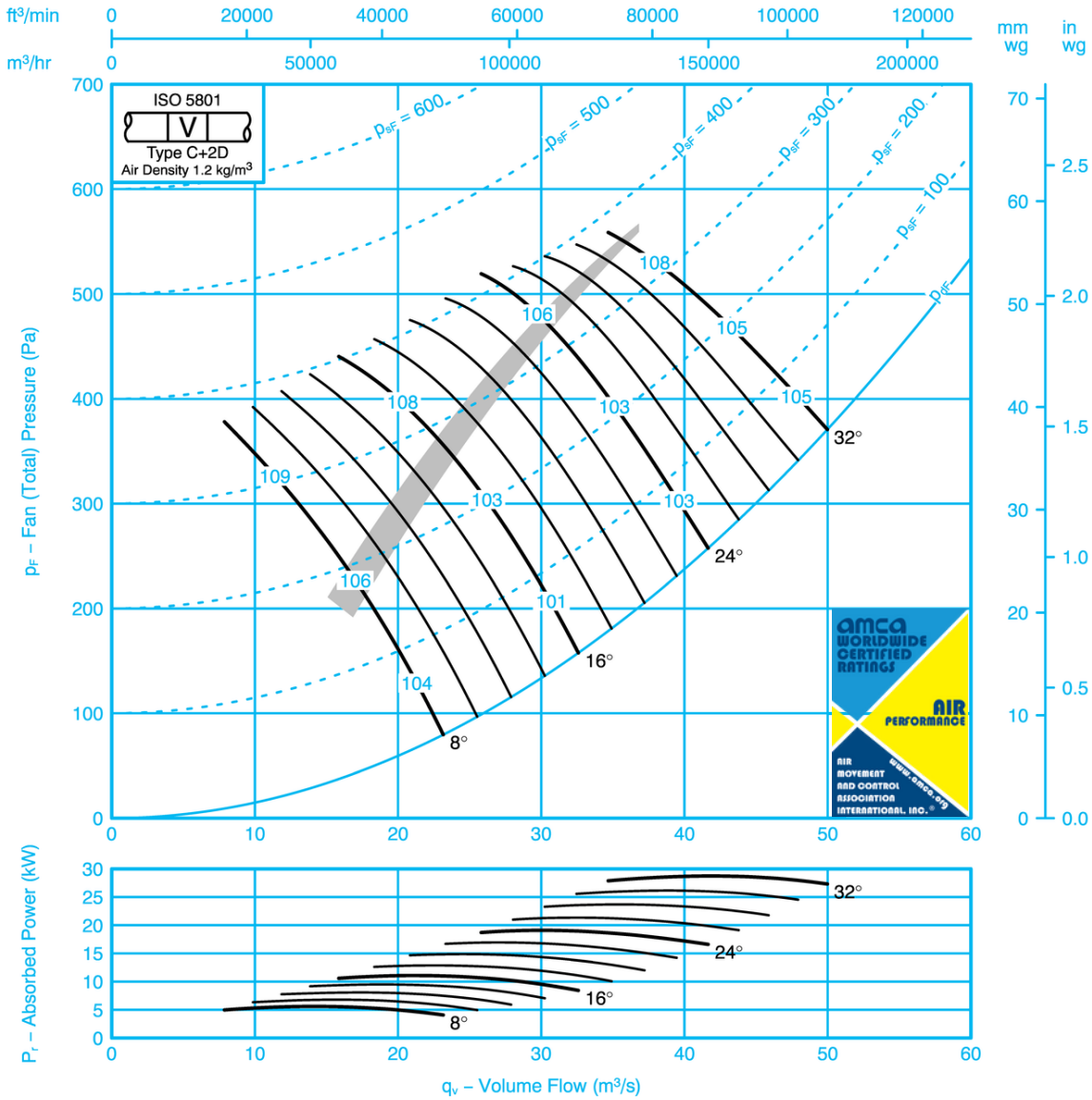

If it is intended to run this fan in reverse for other than emergency operation, please refer to Woods Air Movement.

Sound Data ISO 5136

Single figures on performance curves are overall inlet sound power levels, derived from measurements taken in Woods laboratory specifically under ducted conditions. For sound power levels in eight octave bands, apply the following corrections to the overall level. Use upper corrections when operating point is above shaded area, or lower corrections when operating point is below shaded area.

Inlet Levels								Outlet Levels									
Pitch Angle	Octave Band Centre Frequency (Hz)								Pitch Angle	Octave Band Centre Frequency (Hz)							
	63	125	250	500	1k	2k	4k	8k		63	125	250	500	1k	2k	4k	8k
8	-20	-14	-7	-4	-8	-14	-17	-24	8	-16	-12	-6	-3	-7	-12	-16	-23
	-17	-14	-13	-7	-4	-7	-9	-21		-14	-12	-12	-6	-4	-6	-8	-19
16	-15	-14	-11	-4	-5	-9	-13	-16	16	-12	-13	-11	-4	-5	-9	-11	-15
	-11	-9	-10	-8	-7	-8	-9	-14		-8	-8	-9	-7	-7	-8	-8	-13
24-32	-13	-8	-7	-6	-9	-14	-17	-19	24-32	-10	-7	-6	-4	-8	-12	-15	-17
	-9	-8	-9	-8	-8	-10	-12	-13		-6	-6	-7	-6	-8	-9	-10	-11

SK12053

WAM_DC_00073GB_60HZ JM AEROFOIL
January 2024



FAN CODE: 160JM/40/8/9/...
 1600mm 865 rev/min 9 Blades 60 Hz

Performance Data ISO 5801

Performance shown is for installations type C—Ducted inlet, Ducted outlet. Performance ratings do not include the effects of appurtenances.

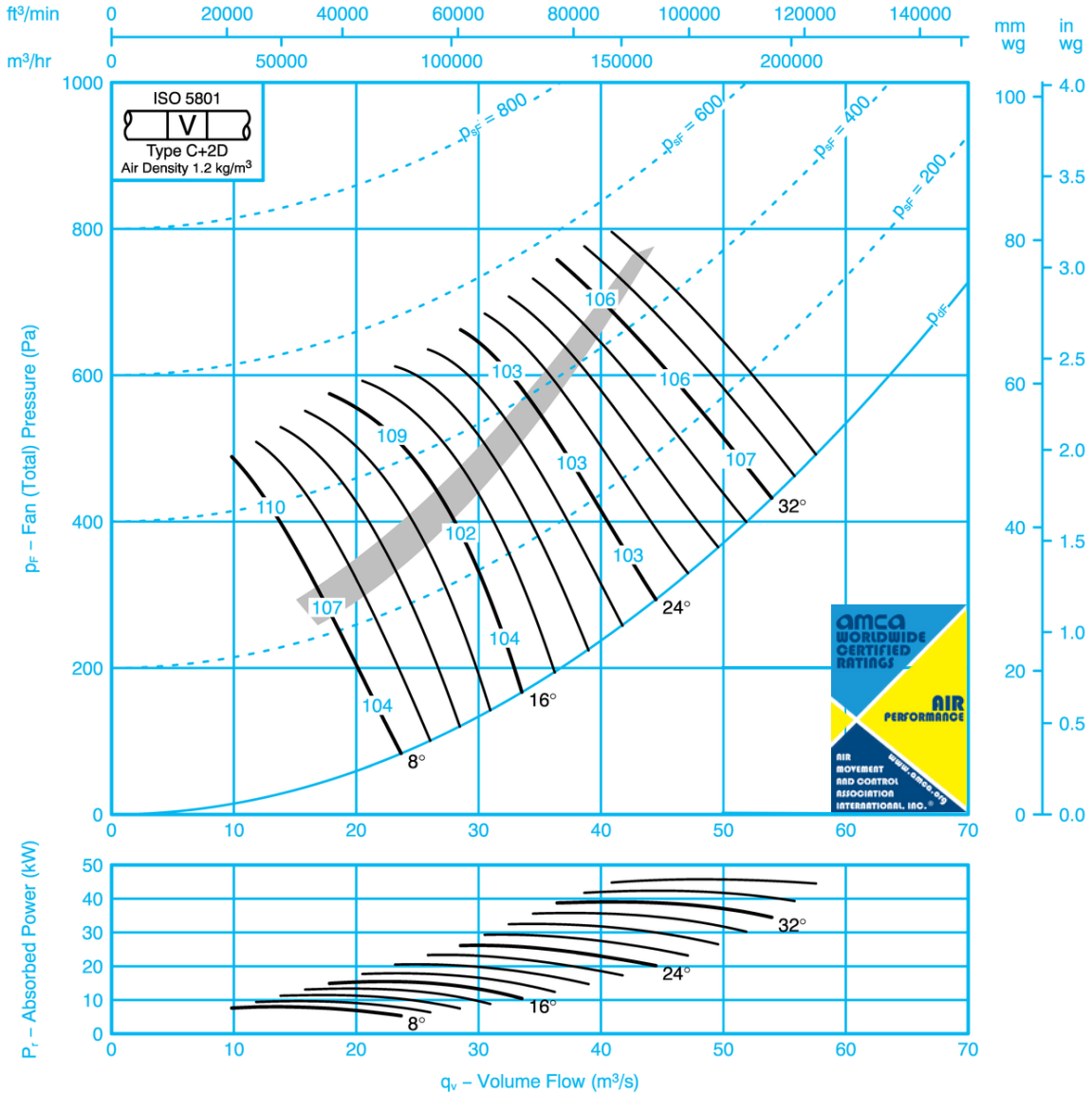

If it is intended to run this fan in reverse for other than emergency operation, please refer to Woods Air Movement.

Sound Data ISO 5136

Single figures on performance curves are overall inlet sound power levels, derived from measurements taken in Woods laboratory specifically under ducted conditions. For sound power levels in eight octave bands, apply the following corrections to the overall level. Use upper corrections when operating point is above shaded area, or lower corrections when operating point is below shaded area.

Inlet Levels								Outlet Levels									
Pitch Angle	Octave Band Centre Frequency (Hz)							Pitch Angle	Octave Band Centre Frequency (Hz)								
	63	125	250	500	1k	2k	4k		8k	63	125	250	500	1k	2k	4k	8k
8	-23	-17	-9	-3	-7	-15	-17	-27	8	-20	-14	-8	-1	-6	-13	-17	-26
	-20	-14	-14	-6	-5	-7	-9	-21		-17	-11	-13	-5	-3	-6	-9	-20
16	-19	-16	-9	-3	-7	-13	-17	-22	16	-15	-14	-9	-3	-6	-12	-15	-20
	-13	-7	-11	-10	-9	-7	-7	-16		-9	-4	-9	-10	-8	-7	-7	-14
24-36	-9	-10	-10	-7	-7	-9	-12	-12	24-36	-5	-7	-8	-7	-6	-8	-10	-11
	-8	-8	-9	-8	-8	-9	-12	-13		-4	-4	-7	-7	-7	-9	-9	-12

SK12054

WAM_DC_00073GB_60HZ JM AEROFOIL
 January 2024



Performance Data ISO 5801

Performances shown is for installations type C – Ducted inlet, Ducted outlet. Performance ratings do not include the effects of appurtenances.

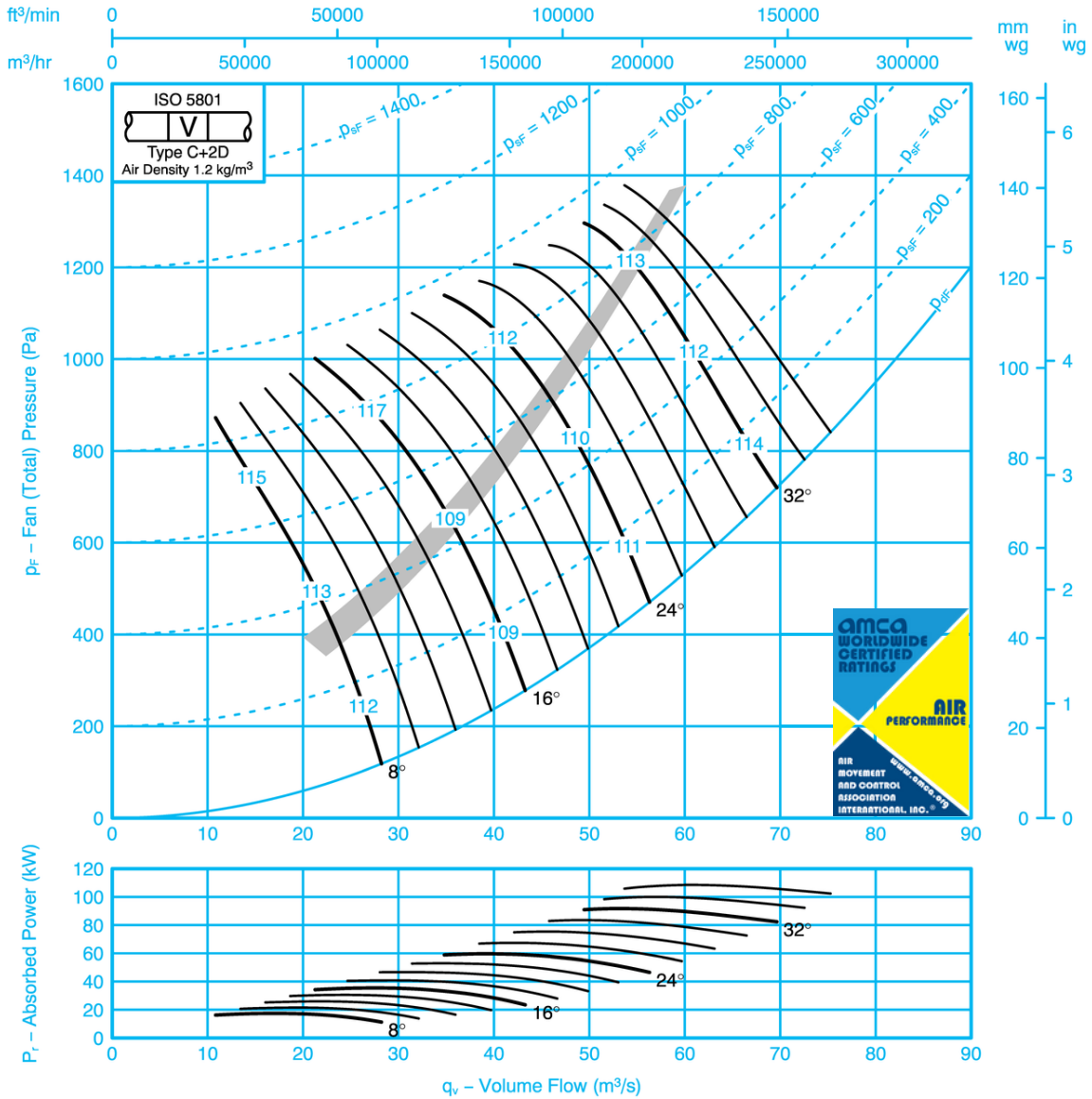

If it is intended to run this fan in reverse for other than emergency operation, please refer to Woods Air Movement.

Sound Data ISO 5136

Single figures on performance curves are overall inlet sound power levels, derived from measurements taken in Woods laboratory specifically under ducted conditions. For sound power levels in eight octave bands, apply the following corrections to the overall level. Use upper corrections when operating point is above shaded area, or lower corrections when operating point is below shaded area.

Inlet Levels									Outlet Levels								
Pitch Angle	Octave Band Centre Frequency (Hz)								Pitch Angle	Octave Band Centre Frequency (Hz)							
	63	125	250	500	1k	2k	4k	8k		63	125	250	500	1k	2k	4k	8k
8	-19	-14	-9	-4	-5	-10	-13	-21	8	-16	-11	-8	-3	-5	-9	-13	-20
	-19	-17	-14	-10	-5	-6	-6	-17		-16	-14	-13	-9	-4	-5	-5	-15
16	-17	-14	-8	-4	-6	-11	-16	-21	16	-14	-12	-7	-3	-5	-10	-15	-20
	-11	-11	-9	-9	-8	-7	-6	-15		-8	-8	-7	-8	-8	-6	-5	-14
24-36	-11	-12	-8	-5	-7	-9	-14	-15	24-36	-8	-9	-7	-5	-6	-8	-13	-14
	-8	-9	-7	-8	-9	-9	-11	-13		-5	-7	-5	-7	-8	-8	-10	-12



FAN CODE: 160JM/50/6/12/...
 1600mm 1150 rev/min 12 Blades 60 Hz

Performance Data ISO 5801

Performances shown is for installation type C – Ducted inlet, Ducted outlet. Performance ratings do not include the effects of appurtenances.

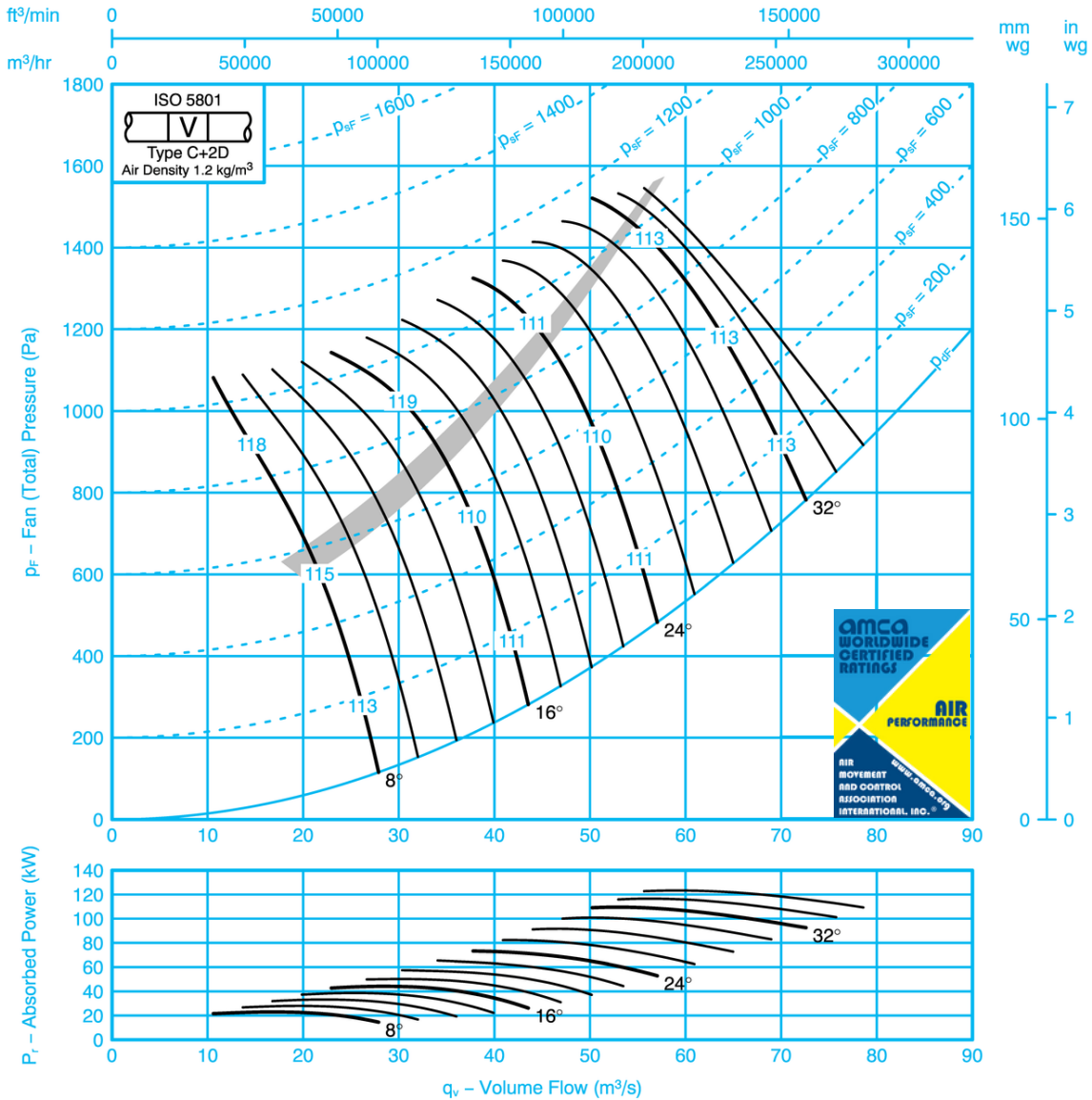

If it is intended to run this fan in reverse for other than emergency operation, please refer to Woods Air Movement.

Sound Data ISO 5136

Single figures on performance curves are overall inlet sound power levels, derived from measurements taken in Woods laboratory specifically under ducted conditions. For sound power levels in eight octave bands, apply the following corrections to the overall level. Use upper corrections when operating point is above shaded area, or lower corrections when operating point is below shaded area.

Inlet Levels									Outlet Levels								
Pitch Angle	Octave Band Centre Frequency (Hz)								Pitch Angle	Octave Band Centre Frequency (Hz)							
	63	125	250	500	1k	2k	4k	8k		63	125	250	500	1k	2k	4k	8k
8	-23	-16	-10	-3	-5	-12	-15	-24	8	-20	-15	-8	-3	-4	-10	-13	-22
	-22	-19	-14	-8	-4	-7	-8	-18		-19	-18	-11	-7	-3	-4	-5	-16
16	-16	-18	-13	-6	-4	-7	-12	-18	16	-13	-16	-11	-6	-3	-7	-9	-17
	-12	-15	-9	-11	-8	-7	-5	-13		-9	-13	-7	-11	-7	-6	-2	-10
24-36	-9	-12	-9	-7	-7	-9	-12	-14	24-36	-6	-9	-7	-6	-6	-8	-11	-13
	-7	-10	-8	-9	-9	-9	-11	-14		-3	-6	-5	-8	-8	-9	-9	-13

SK12058

WAM_DC_00073GB_60HZ JM AEROFOIL
 January 2024



USEFUL INFORMATION

FAN LAWS

SPEED CHANGE - CONSTANT SIZE - CONSTANT DENSITY

Volume Flow	∞	Rotational Speed
Pressure (Static, Dynamic and Total)	∞	(Rotational Speed) ²
Power Absorbed	∞	(Rotational Speed) ³

SIZE CHANGE - CONSTANT SPEED - CONSTANT DENSITY

(For geometrically similar fans only)

Volume Flow	∞	(Impeller Diameter) ³
Pressure (Static, Dynamic and Total)	∞	(Impeller Diameter) ²
Power Absorbed	∞	(Impeller Diameter) ⁵

DENSITY CHANGE - CONSTANT SPEED - CONSTANT SIZE

Volume Flow	=	No change
Pressure (Static, Dynamic and Total)	∞	Density
Power Absorbed	∞	Density

The laws can be combined where simultaneous changes in size, speed and density are required.

AIR DENSITY

Standard Air density is 1.2 kg/m³

One condition that gives Standard Air is:-

16°C, 100 kPa barometric pressure, 65% relative humidity

CHANGE DUE TO TEMPERATURE

$$\text{New Density} = \text{Old Density} \times \left(\frac{273 + \text{Old Temperature } ^\circ\text{C}}{273 + \text{New Temperature } ^\circ\text{C}} \right) \text{ kg/m}^3$$

CHANGE DUE TO ALTITUDE

$$\text{New Density} = \text{Old Density} \times \left(\frac{288 - 0.00649 H}{288} \right)^{4.256} \text{ kg/m}^3$$

Where H = Height above sea level in metres

PRESSURE

$$\text{Dynamic Pressure} = 0.5\rho (V)^2 \text{ Pa}$$

Where	ρ	=	Air Density	kg/m ³
	V	=	Air Velocity	m/s

$$\text{Total Pressure} = \text{Static Pressure} + \text{Dynamic Pressure}$$

ABSORBED POWER

$$\text{Absorbed Power} = \frac{\text{Volume flow (m}^3\text{/s)} \times \text{Total Pressure (Pa)}}{\text{Total Efficiency} \times 10} \text{ kW}$$



Woods Air Movement delivers smart and energy efficient Air Movement and Fire Safety solutions to support every application area. We offer our customers innovative technologies, high quality and outstanding performance. The widest range of Air Movement and Ventilation products in the market, and strong market presence with over 100 years of experience and manufacturing of products, guarantees that we are always by your side, ready to deliver Excellence in Solutions.

**Contact our friendly sales team today
for more information**

Call: +44 (0) 1206 222 555

**Email: quotations.woods@flaktgroup.com
www.woodsairmovement.com**

